

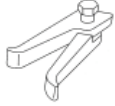

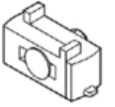

## Transmission - Repair and Assembly Procedure

### Special Tool(s) / General Equipment





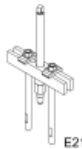

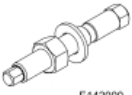

#### Disassembly

 307-163	<a href="#">307-163</a> (T86P-70043-A) Remover, Stator Case Bearing TKIT-1986-F TKIT-1986-LM
	<a href="#">307-586</a> Remover, Differential Bearing Cup TKIT-2006UF-FLM TKIT-2006UF-ROW
 E135106	<a href="#">308-001</a> (T58L-101-B) Remover, Pilot Bearing
Hydraulic Press	
Puller	
Punch	

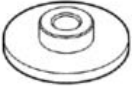
#### Differential - Disassembly and Assembly

 E216580	<a href="#">204-069</a> (T81P-1104-C) Remover/Installer, Front Wheel Hub
	<a href="#">307-587</a> Installer and Guide, Differential Bearing TKIT-2006UF-FLM TKIT-2006UF-ROW
Hydraulic Press	
Puller	

#### Assembly

 E142000	<a href="#">204-029</a> Drawbar
 E133913	<a href="#">205-153</a> (T80T-4000-W) Handle
	<a href="#">307-541</a> Installer, Transfer Gear Bearing TKIT-2005D1-F
	<a href="#">307-576</a> Installer, Bearing Cup TKIT-2006UF-FLM TKIT-2006UF-ROW
	<a href="#">307-591</a> Shim Gauge, Differential/Transfer Gear Bearing TKIT-2006UF-FLM TKIT-2006UF-ROW
 E216426	<a href="#">307-626</a> Installer, Differential Seal TKIT-2008ET-FLM TKIT-2008ET-ROW
 E129543	<a href="#">307-672</a> Installer, Input Guide and Seal TKIT-2010D-FLM TKIT-2010D-ROW
 E152368	<a href="#">307-692</a> Tool, Transfer Gear Preload TKIT-2012C-FL TKIT-2012C-ROW TKIT-2012C-ROW2
 E152369	<a href="#">307-693</a> Installer, Transfer Gear Bearing Cup TKIT-2012C-FL TKIT-2012C-ROW TKIT-2012C-ROW2
Feeler Gauge	
Hydraulic Press	

