

**Dealer TO: ALL OLDSMOBILE DEALERS**

**Salutation: ATTENTION: SERVICE MANAGER, PARTS MANAGER AND WARRANTY  
ADMINISTRATOR**

**GM SERVICE AND PARTS OPERATIONS**

**DCS1193**

**URGENT DISTRIBUTE IMMEDIATELY**

**DATE: May 26, 2004**

**SUBJECT: 04014 / Product Safety Recall  
Engine Fuel Rail - Replace**

**MODELS: 1996-1997 Oldsmobile Aurora**

**TO: All Oldsmobile Dealers**

**ATTENTION: Service Manager, Parts Manager and Warranty Administrator**

**PRODUCT FIELD ACTION ANNOUNCEMENT**

**General Motors is announcing Product Safety Recall 04014 today. The total number of vehicles involved is 48,233. Please see the attached bulletin for details.**

**Mailing Information: Customer letter mailing will begin on June 2, 2004.**

**GM Vehicle Inquiry System (GMVIS): GMVIS information will be available on May 27, 2004.**

**Service Information System (SI): Bulletin 04014 is scheduled to be available in SI on June 4, 2004.**

**PLEASE DOUBLE CLICK ON THE ICON BELOW  
THEN SINGLE CLICK ON THE LAUNCH BUTTON  
TO VIEW OR PRINT THE BULLETIN**

**(See attached file: 04014 Bulletin.pdf)**

**END OF MESSAGE**

**GM SERVICE AND PARTS OPERATIONS**



# Recall Bulletin

File In Section: Product Recalls  
Bulletin No.: 04014  
Date: May 2004



## PRODUCT SAFETY RECALL

**SUBJECT:** ENGINE FUEL RAIL - REPLACE

**MODELS:** 1996-1997 OLDSMOBILE AURORA

This bulletin will be revised when service parts become available to add 1995 Oldsmobile Aurora and 1995-1997 Cadillac DeVille, Seville and Eldorado model vehicles.

### CONDITION

General Motors has decided that a defect, which relates to motor vehicle safety, exists in all 1996-1997 Oldsmobile Aurora model vehicles. These vehicles have a condition in which the original equipment nylon tubing used in the fuel rail construction may degrade and crack. Cracking of the fuel rail can result in a fuel leak into the engine compartment. The operator may experience fuel odor and possibly engine stalling due to loss of fuel pressure to the engine. If this event were to occur, and if an ignition source were present, an engine compartment fire could occur.

### CORRECTION

Dealers are to inspect and, if necessary, replace the engine fuel rail with a new stainless steel fuel rail.

### VEHICLES INVOLVED

Involved are all 1996-1997 Oldsmobile Aurora model vehicles; and built within these VIN breakpoints:

YEAR	DIVISION	MODEL	FROM	THROUGH
1996	Oldsmobile	Aurora	T4100001	T4124133
1997	Oldsmobile	Aurora	V4100001	V4127927

**IMPORTANT:** Dealers should confirm vehicle eligibility through **GM VIS** (GM Vehicle Inquiry System) prior to beginning recall repairs.

**For US:** For dealers with involved vehicles, a Campaign Initiation Detail Report containing the complete Vehicle Identification Number, customer name and address data has been prepared and will be loaded to the GM

DealerWorld, Recall Information website. Dealers that have no involved vehicles currently assigned, will not have a report available in GM DealerWorld.

The Campaign Initiation Detail Report may contain customer names and addresses obtained from Motor Vehicle Registration Records. The use of such motor vehicle registration data for any purpose other than follow-up necessary to complete this recall is a violation of law in several states/provinces/countries. Accordingly, you are urged to limit the use of this report to the follow-up necessary to complete this recall.

#### Parts Pre-Ship Information – For US

**Important:** An initial supply of Rail Kits and Seal Kits required to complete this recall will be pre-shipped to involved dealers of record. This pre-shipment is scheduled to begin the week of May 24, 2004 and will be approximately 15% of each dealer's involved vehicles. Pre-shipped parts will be charged to dealer's open parts account.

Additional parts, if required, are to be obtained from General Motors Service Parts Operations (GMSPO). Please refer to your "involved vehicles listing" before ordering parts. Normal orders should be placed on a DRO = Daily Replenishment Order. In an emergency situation, parts should be ordered on a CSO = Customer Special Order.

Part Number	Description	Quantity/Vehicle
12583145	Rail Kit, MPort F/Injn Fuel (1996-97 Oldsmobile)	1
17800052	Seal Kit, MPort F/Injr (1996-97 Oldsmobile)	1
12345579	Grease, Dielectric Silicone (1 oz.)	As needed

#### SERVICE PROCEDURE

**Category - Recall Service Procedure and Labor Time Allowance is Different Than Service Manual Information and Labor Time Guide.**

**IMPORTANT:** The service procedure contained in this recall is different from the service procedure found in the appropriate service manual. As a result, the labor time allowance has been revised to correspond with this new service procedure. In the near future the service manual and labor time guide will be updated with this new information.

#### Inspection Procedure

1. Prep the Vehicle.
2. Remove the Acoustic Engine Cover and inspect the fuel rail for replacement qualification:
  - 2.1. If the fuel rail has the words "GM213M Type F" or "M-Bond" written on the tubing with a dot ink-jet type white/yellow printing, it is a service fuel rail with the M-Bond tubing and does not need replacement. Submit a claim for inspect only and close the recall.
  - 2.2. If the fuel rail is a stainless steel material, it is a service fuel rail and does not need replacement. Submit a claim for inspect only and close the recall.

- 2.3. If the words "GM213M Type F" or "M-Bond" are not clearly readable on the tubing or the rail is not constructed of stainless steel, the fuel rail requires replacement. Continue with the fuel rail removal and replacement procedure.

### **Fuel Rail Removal and Replacement Procedure**

#### **Tools Required**

- J 34730-1A Fuel Pressure Gauge
- J 37088-A Fuel Line Disconnect Tool Set
- J 41081 Injector Remover

**NOTICE:** Do NOT remove the air cleaner assembly, intake air duct, throttle body or EGR pipe. The replacement fuel rail does not require the removal of these components due to the revised design. Removal of components not necessary for this procedure will require replacement of damaged gaskets and EGR pipe.

#### **Fuel Rail Removal**

1. Allow engine to cool to ambient temperature.
2. Note the customer's radio settings.
3. Raise the hood.



1461407

4. Open the fuel filler door.
5. Unscrew the fuel filler cap in order to relieve gas tank pressure.



226002

**CAUTION:** Before servicing any electrical component, the ignition key must be in the OFF or LOCK position and all electrical loads must be OFF, unless instructed otherwise in these procedures. If a tool or equipment could easily come in contact with a live exposed electrical terminal, also disconnect the negative battery cable. Failure to follow these precautions may cause personal injury and/or damage to the vehicle or its components.

6. Disconnect the negative cable at the battery.

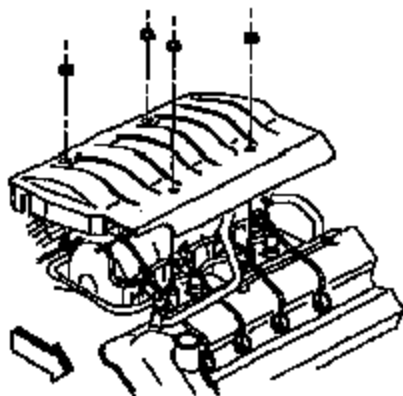

42731

7. Remove the 4 fuel injector sight shield nuts.

8. Remove the fuel injector sight shield.

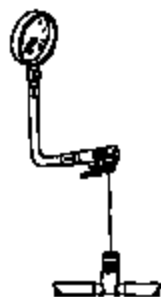

180376

**CAUTION:** \* Relieve the fuel system pressure before servicing fuel system components in order to reduce the risk of fire and personal injury.

\* After relieving the system pressure, a small amount of fuel may be released when servicing the fuel lines or connections. In order to reduce the chance of personal injury, cover the regulator and the fuel line fittings with a shop towel before disconnecting. This will catch any fuel that may leak out. Place the towel in an approved container when the disconnection is complete.

9. Relieve the fuel rail pressure at test port connection with the J 34730-1A.

- 9.1. Wrap a shop towel around test port connection while connecting gage to avoid spillage.
- 9.2. Connect the gauge to the test port connection.
- 9.3. Install the bleed hose into an approved container.
- 9.4. Open bleed valve to bleed system pressure.
- 9.5. Drain any fuel remaining in J 34730-1A into an approved container.

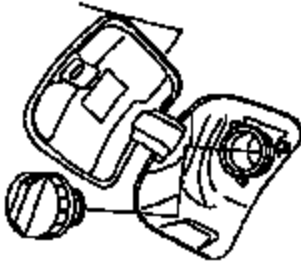

1461437

10. Tighten the fuel filler cap.

11. Close the fuel filler door.

**CAUTION:** Wear safety glasses when using compressed air, as flying dirt particles may cause eye injury.

12. Blow dirt out from around fuel injectors, fuel pressure regulator, and the fuel injector wiring harness connectors using compressed air.



167703

13. Grasp both sides on either side of the quick-connect fitting and twist the female (rail side) connector 1/4 turn in each direction to loosen any dirt within the fitting.

14. Repeat step 13 to second fuel line.

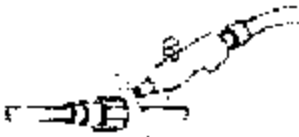

155410

15. Blow dirt out of the fittings using compressed air.
16. Place a shop towel below the fuel line fittings while disconnecting to avoid spillage.



1277

17. Squeeze the plastic retainer tabs in order to release the locking tabs.



12778

18. Pull the upper fuel line connection apart.
19. Repeat steps 17 and 18 for the lower fuel line.
20. Remove the PCV rear hose.

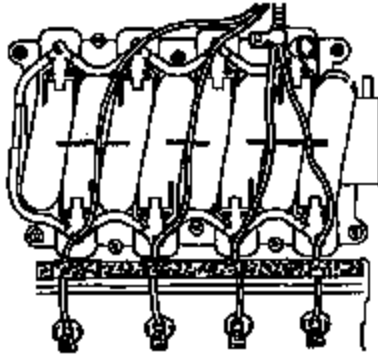

71512

21. Remove the spark plug harness retainer from the fuel injector sight shield stud.
22. Disconnect the front spark plug wires from the front spark plugs and reposition.
23. Disconnect the fuel regulator hose from the fuel regulator.

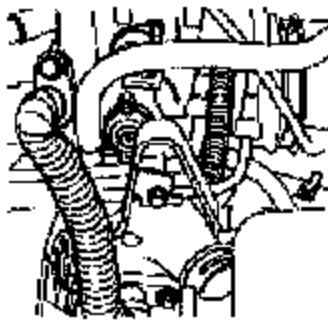

1461652

24. Remove the fuel rail bracket bolt from the engine lift bracket.
25. Remove the fuel injector sight shield studs and spacers.
26. Disconnect the fuel injector wiring harness from the 8 fuel injectors and reposition the fuel injector wiring harness.





1481182

27. Remove the grounding harness bolt from the front of the right (rear) cylinder head.
28. Remove the fuel rail ground harness.

**NOTICE:** Use the correct fastener in the correct location. Replacement fasteners must be the correct part number for that application. Fasteners requiring replacement or fasteners requiring the use of thread locking compound or sealant are identified in the service procedure. Do not use paints, lubricants, or corrosion inhibitors on fasteners or fastener joint surfaces unless specified. These coatings affect fastener torque and joint clamping force and may damage the fastener. Use the correct tightening sequence and specifications when installing fasteners in order to avoid damage to parts and systems.

29. Reinstall the grounding harness bolt with the ECM/ignition coil ground harness.

**Tighten**

Tighten the grounding harness bolt to 25 Nm (18 lb ft).

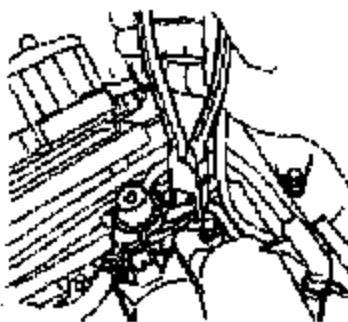

1481622

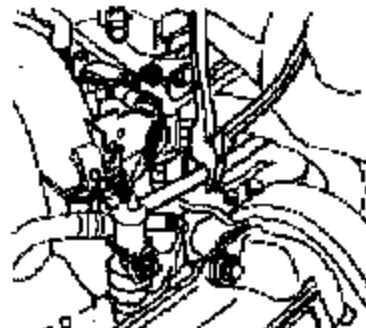

1481625

30. Cut the fuel rail flexible plastic tubes with diagonal cutters.

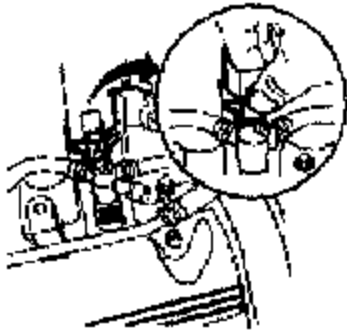

1461182

31. Release the locking tabs holding the fuel rail to the intake manifold.

- NOTICE:**
- \*Remove the fuel rail assembly carefully in order to prevent damage to the injector electrical connector terminals and the injector spray tips. Support the fuel rail after the fuel rail is removed in order to avoid damaging the fuel rail components.
  - \* Cap the fittings and plug the holes when servicing the fuel system in order to prevent dirt and other contaminants from entering open pipes and passages.

32. Remove the fuel rail and fuel injectors as an assembly from the intake manifold. Use the J 41081 to aid in removing any injectors stuck in the intake manifold. Place the J 41081 between the intake manifold and the bottom of the fuel injector.

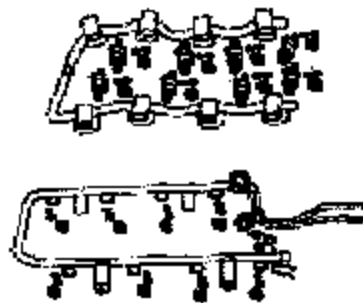

1461167

33. Place the old fuel rail assembly on a clean, flat surface next to and in the same orientation as the new fuel rail assembly.

### Fuel Rail Disassembly and Assembly

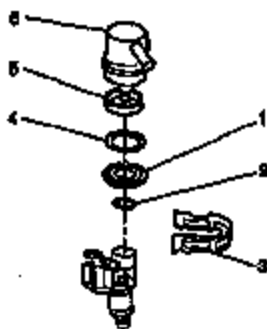

190617

#### NOTICE:

- \* Do not use compressed air to test or clean a fuel pressure regulator. Excessive air pressure can damage the fuel pressure regulator.
- \* Do not immerse the fuel pressure regulator in a cleaning solvent in order to prevent damage to the regulator.
- \* Use ONLY clean engine oil to lubricate O-rings. In order to prevent damage to the fuel pressure regulator, do NOT use any other type of lubricant.

1. Remove the fuel regulator from the old fuel rail assembly.
  - 1.1. Remove the retaining fuel regulator clip (3).
  - 1.2. Lift, twist and remove the fuel rail regulator (6) from the fuel rail socket.



1481201

2. Install the fuel regulator into the NEW fuel rail assembly.
  - 2.1. Coat with clean engine oil the NEW small O-ring (1) and install into the fuel rail socket.
  - 2.2. Install the NEW regulator filter screen (2).
  - 2.3. Coat with clean engine oil the NEW large O-ring (3) and install into the fuel rail socket.
  - 2.4. Install the NEW O-ring back-up (4) into the fuel rail socket.
  - 2.5. Insert the fuel regulator (5) into the fuel rail socket using a turning motion to properly seat the O-rings.
  - 2.6. Install the NEW retaining fuel regulator clip (6).
3. Exchange each fuel injector from the old fuel rail assembly to the NEW fuel rail assembly one at a time in order to keep each injector in its original position.

- 3.1. Spread and release the fuel injector clip from the old fuel rail assembly.
- 3.2. Remove the fuel injector assembly.

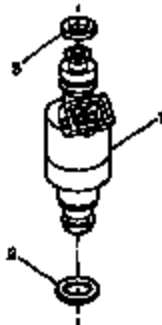

168577

- 3.3. Remove the upper (3) and lower (2) fuel injector O-rings.

**IMPORTANT:** Use ONLY clean engine oil to lubricate O-rings. Do NOT use any other type of lubricant or grease.

- 3.4. Coat with clean engine oil the NEW O-rings and install onto the fuel injector assembly.



1481203

- 3.5. Install the fuel injector assembly into the same location on the NEW fuel rail assembly with the wiring harness connector facing the outboard direction.

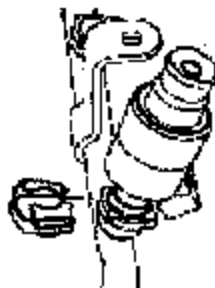

1481206

- 3.6. Install the NEW fuel injector clip onto the NEW fuel rail assembly.
  - 3.7. Repeat steps 3.1. through 3.6. on the remaining fuel injectors.
4. Transfer the plastic fuel line retainers from the old fuel rail to the NEW fuel rail.

### Fuel Rail Installation

1. Place the NEW fuel rail assembly into position.

- 1.1. Align the fuel injectors to the fuel injector bores in the intake manifold.
- 1.2. Align the fuel injector assembly bracket to the engine lift bracket.
- 1.3. Apply pressure to fuel rail assembly to seat fuel injectors into fuel injector bores in the intake manifold.

**NOTICE:** Use the correct fastener in the correct location. Replacement fasteners must be the correct part number for that application. Fasteners requiring replacement or fasteners requiring the use of thread locking compound or sealant are identified in the service procedure. Do not use paints, lubricants, or corrosion inhibitors on fasteners or fastener joint surfaces unless specified. These coatings affect fastener torque and joint clamping force and may damage the fastener. Use the correct tightening sequence and specifications when installing fasteners in order to avoid damage to parts and systems.

2. Install the fuel rail injector sight shield spacers and studs.

#### Tighten

Tighten the fuel rail injector sight shield studs to 12 Nm (106 lb in).

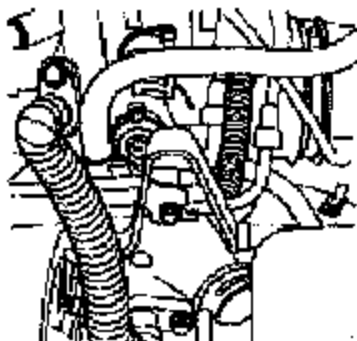

1401032

3. Install the bolt retaining the fuel rail assembly bracket to the engine lift bracket.

#### Tighten

Tighten the fuel rail assembly bracket bolt to 6 Nm (53 lb in).

4. Connect the fuel injector wiring harness to the 8 fuel injectors and reinstall the fuel injector wiring harness.
5. Connect the NEW fuel regulator hose to the fuel regulator and the vacuum port on the intake manifold.
6. Install the PCV rear hose.
7. Apply dielectric grease GM P/N 12345579, (Canadian P/N 1974984) to each spark plug boot. Route and connect the front spark plug wires to the front spark plugs.

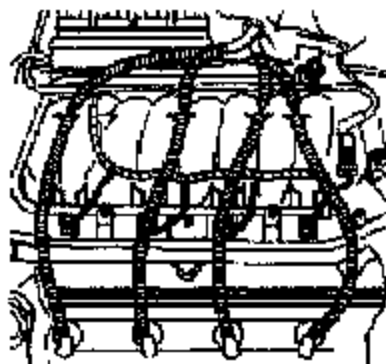

1401220

**Important:** Conduit installed in next step may be obtained locally if conduit ID and underhood temperature specifications are equivalent.

8. Install wire conduit GM P/N 8919354 or equivalent over each of the front spark plug wires where the spark plug wires lay across the fuel rail on both sides. (Approximately 6 feet required per vehicle.)

\* Between the spark plug boot and the retainer in the center of the intake manifold add a 300 mm (12 in) section of conduit on each of the left side spark plug wires.

\* Between the retainer in the center of the intake manifold and the conduit already installed add the following sections of conduit on each left side spark plug wires:

- 230 mm (9 in) on the number 2 spark plug wire
- 150 mm (6 in) on the number 4 spark plug wire
- 110 mm (4.5 in) on the number 6 and 8 spark plug wire

9. Install the fuel line connections.

**NOTICE:** If necessary, remove rust or burrs from the fuel pipes with an emery cloth. Use a radial motion with the fuel pipe end in order to prevent damage to the O-ring sealing surface. Use a clean shop towel in order to wipe off the male tube ends. Inspect all the connections for dirt and burrs. Clean or replace the components and assemblies as required.

10. Clean the quick-connect fittings.



165425

**CAUTION:** In order to reduce the risk of fire and personal injury, before connecting fuel pipe fittings, always apply a few drops of clean engine oil to the male pipe ends. This will ensure proper reconnection and prevent a possible fuel leak. During normal operation, the O-rings located in the female connector will swell and may prevent proper reconnection if not lubricated.

11. Apply a few drops of clean engine oil to the male ends of the engine fuel rail inlet and outlet pipes.

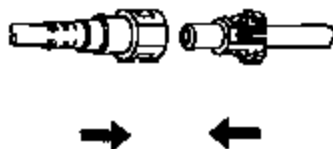

165771

12. Connect the quick-connect fittings to the fuel rail. Push both sides of the fitting together to cause the retaining tabs/fingers to snap into place.

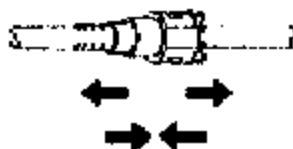

155300

13. Pull on both sides of the fitting to ensure connection is secure once installed.

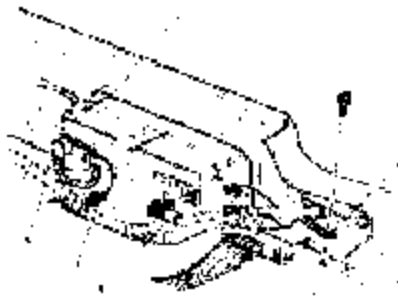

228002

14. Connect the negative cable at the battery.

15. Tighten the negative cable bolt at the battery.

**Tighten**

Tighten the negative cable bolt to 15 Nm (11 lb ft).

16. Check for fuel leaks.

16.1. Turn the Ignition switch ON for 2 seconds.

16.2. Turn the ignition switch OFF for 10 seconds.

16.3. Turn the ignition switch ON.

16.4. Check for fuel leaks.

16.5. Start vehicle and allow engine to reach operating temperature while observing for fuel leaks.

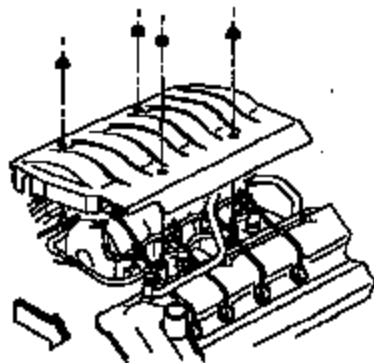

42761

17. Install the fuel injector sight shield.

18. Install the 4 fuel injector sight shield nuts.

**Tighten**

Tighten the fuel injector sight shield nuts to 3 Nm (27 lb in).

19. Close the hood and reset the customer's radio settings.



**CUSTOMER REIMBURSEMENT** For US

All customer requests for reimbursement for previous repairs for the recall condition will be handled by the Customer Assistance Center, not by dealers.

A General Motors Product Recall Customer Reimbursement Procedure Form is included with the customer letter.

**IMPORTANT:** Refer to the GM Service Policies and Procedures Manual, section 6.1.12, for specific procedures regarding customer reimbursement and the form.

**CLAIM INFORMATION**

Submit a Product Recall Claim with the information indicated below:

REPAIR PERFORMED	PART COUNT	PART NO.	PARTS ALLOW	CC-FC	LABOR OP	LABOR HOURS	NET ITEM
Inspect engine fuel rail, no replacement required	N/A	N/A	N/A	MA-86	V1148	0.2	N/A
Inspect and Replace engine fuel rail. 1996-97 Aurora	-	-	**	MA-86	V1149	1.0*	***

\* For Recall Administrative Allowance, add 0.1 hours to the "Labor Hours".

\*\* The "Parts Allowance" should be the sum total of the current GMSPO Dealer net price plus applicable Mark-Up or Landed Cost Mark-Up (for IPC) for the fuel rail/seal kits needed to complete the repair.

\*\*\* The amount identified in the "Net Item" column should represent the sum total of the current GMSPO Dealer net price plus applicable Mark-Up or Landed Cost Mark-Up (for IPC) for shop supplies needed to perform the required repairs.

Refer to the General Motors WINS Claims Processing Manual for details on Product Recall Claim Submission.

**CUSTOMER NOTIFICATION** – For US

General Motors will notify customers of this recall on their vehicle (see copy of customer letter included with this bulletin).

**DEALER RECALL RESPONSIBILITY**

The US National Traffic and Motor Vehicle Safety Act provides that each vehicle that is subject to a recall of this type must be adequately repaired within a reasonable time after the customer has tendered it for repair. A failure to repair within sixty days after tender of a vehicle is prima facie evidence of failure to repair within a reasonable time. If the condition is not adequately repaired within a reasonable time, the customer may be entitled to an identical or reasonably equivalent vehicle at no charge or to a refund of the purchase price less a reasonable allowance for depreciation. To avoid having to provide these

burdensome remedies, every effort must be made to promptly schedule an appointment with each customer and to repair their vehicle as soon as possible. In the recall notification letters, customers are told how to contact the US National Highway Traffic Safety Administration if the recall is not completed within a reasonable time.

All unsold new vehicles in dealers' possession and subject to this recall must be held and inspected/repaired per the service procedure of this recall bulletin before customers take possession of these vehicles.

Dealers are to service all vehicles subject to this recall at no charge to customers, regardless of mileage, age of vehicle, or ownership, from this time forward.

Customers who have recently purchased vehicles sold from your vehicle inventory, and for which there is no customer information indicated on the dealer listing, are to be contacted by the dealer. Arrangements are to be made to make the required correction according to the instructions contained in this bulletin. A copy of the customer letter is provided in this bulletin for your use in contacting customers. Recall follow-up cards should not be used for this purpose, since the customer may not as yet have received the notification letter.

In summary, whenever a vehicle subject to this recall enters your vehicle inventory, or is in your dealership for service in the future, you must take the steps necessary to be sure the recall correction has been made before selling or releasing the vehicle.

---

Old bulletins are intended for use by professional technicians, NOT a "Do-It-Yourselfer". They are written to inform these technicians of conditions that may occur on some vehicles, or to provide information that could assist in the proper service of a vehicle. Properly trained technicians have the tools, equipment, safety instructions, and know-how to do a job properly and safely. If a condition is described, DQ MEXI assures that the bulletin applies to your vehicle, or that your vehicle will have that condition. See your dealer/retailer for information on whether your vehicle may benefit from the information.



**We Support  
Vehicular  
Technician  
Certification**

May 2004

**Dear General Motors Customer:**

This notice is sent to you in accordance with the requirements of the National Traffic and Motor Vehicle Safety Act. Federal regulation requires that any vehicle less-or receiving this recall notice must forward a copy of this notice to the lessee within ten days.

**Reason For This Recall:** General Motors has decided that a defect, which relates to motor vehicle safety, exists in all 1996-1997 Oldsmobile Aurora model vehicles. These vehicles have a condition in which the original equipment nylon tubing used in the fuel rail construction may degrade and crack. Cracking of the fuel rail can result in a fuel leak into the engine compartment. The operator may experience fuel odor and possibly engine stalling due to loss of fuel pressure to the engine. If this event were to occur, and if an ignition source were present, an engine compartment fire could occur.

**What Will Be Done:** Your dealer will inspect and, if necessary, replace the engine fuel rail with a new stainless steel fuel rail. This service will be performed for you at no charge.

**How Long Will The Repair Take?** This service correction will take approximately one hour. However, due to service scheduling requirements, your dealer may need your vehicle for a longer period of time.

**Contacting Your Dealer:** To limit any possible inconvenience, we recommend that you contact your Oldsmobile dealer as soon as possible to schedule an appointment for this repair. By scheduling an appointment, your dealer can ensure that the necessary parts will be available on your scheduled appointment date. Should your dealer be unable to schedule a service date within a reasonable time, you should contact the appropriate Customer Assistance Center at the listed number below:

Division	Number	Text Telephones (TTY)
Oldsmobile	1-800-630-6537	1-800-833-6537
Puerto Rico – English	1-800-496-9992	
Puerto Rico – Español	1-800-496-9993	
Virgin Islands	1-800-496-9994	

If, after contacting the appropriate Customer Assistance Center, you are still not satisfied that we have done our best to remedy this condition without charge and within a reasonable time, you may wish to write the Administrator, National Highway Traffic Safety Administration, 400 Seventh Street, SW, Washington, DC 20590 or call 1-888-327-4236.

**Customer Reply Form:** The enclosed customer reply form identifies your vehicle. Presentation of this form to your dealer will assist in making the necessary correction in the shortest possible time. If you no longer own this vehicle, please let us know by completing the form and mailing it back to us.

**Customer Reimbursement:** The enclosed form explains what reimbursement is available and how to request reimbursement if you have paid for repairs for the recall condition.

**Recall Information Online:** More information about this recall (including answers to frequently asked questions) is available online at the Owner Center at MyGMLink. This free online service offers vehicle and ownership-related information and tools tailored to your specific vehicle. To join, visit [www.mygmlink.com](http://www.mygmlink.com) and enter your vehicle's Vehicle Identification Number, shown on the attached card, to get the most personalized information for your vehicle.

We are sorry to cause you this inconvenience; however, we have taken this action in the interest of your safety and continued satisfaction with our products.

Oldsmobile Division  
General Motors Corporation

Enclosure  
04014