

Getting Started Guide **Outback** 2021

**OUTBACK
XT**

Love. It's what makes Subaru, Subaru.



SUBARU

© 2020 Subaru of America, Inc. Printed in USA. All rights reserved. Contents may not be reproduced in whole or in part without prior written permission of publisher. Specifications in this Guide are based on the latest product information available at the time of publication. Some images shown are for illustration purposes only. Some equipment shown in photography within this Guide is optional at extra cost. Specific options may be available only in combination with other options. Specific combinations of equipment or features may vary from time to time, and by geographic area. Subaru of America, Inc. reserves the right to change or discontinue at any time, without notice: Prices, colors, materials, equipment, accessories, specifications, models and packages, without incurring any obligation to make the same or similar changes on vehicles previously sold. Colors shown may vary due to reproduction and printing processes. Subaru of America, Inc. is not responsible for typographical errors. Aha™ is a trademark of Harman International Industries, Incorporated. Alcantara® is a registered trademark of Alcantara S.p.A., and Alcantara is produced by the Toray Group. App Store® is a registered trademark of Apple, Inc. Apple® is a registered trademark of Apple, Inc. Apple CarPlay® is a registered trademark of Apple, Inc. Android Auto™ is a trademark of Google, LLC. BBS® is a registered trademark of BBS Kraftfahrzeugtechnik, AG. Bluetooth® is a registered trademark of Bluetooth SIG, Inc. Brembo® is a registered trademark of Freni Brembo, S.p.A. GreenEdge® is a registered trademark of Harman International Industries, Incorporated. Glympse® is a registered trademark of Glympse, Inc. Grand Luxe® is a registered trademark of Seiren Co., Ltd. HARMAN® is a registered trademark of HARMAN International Industries, Incorporated. Harman Kardon® is a registered trademark of Harman International Industries, Incorporated. Quantum logic™ is a trademark of Harman International Industries, Incorporated. HD Radio® is a registered trademark of iBiquity Digital Corporation. HomeLink® and the HomeLink® house icon are registered trademarks of Gentex Corporation. iHeartRadio® is a registered trademark of iHeartMedia, Inc. iPod® is a registered trademark of Apple, Inc. iTunes® is a registered trademark of Apple, Inc. Magellan® is a registered trademark of MiTAC International Corporation. Michelin® is a registered trademark of Compagnie Générale des Etablissements Michelin. Metal-Matrix Diaphragm (MMD®) is a registered trademark of Harman International Industries, Incorporated. MirrorLink™ is a trademark of Car Connectivity Consortium, LLC. Pandora® is a registered trademark of Pandora Media, Inc. SACHS® is a registered trademark of ZF Friedrichshafen AG. Siri® is a registered trademark of Apple, Inc. Smart Way® is a registered trademark of the U.S. Environmental Protection Agency. Stitcher™ is a trademark of Stitcher™, Inc. TomTom® is a registered trademark of TomTom International BV. TORSEN LSD® is a registered trademark of JTEKT TORSEN North America, Inc. SiriusXM® All Access Radio is a registered trademark of Sirius XM Radio, Inc. SiriusXM Traffic® is a registered trademark of Sirius XM Radio, Inc. SiriusXM Travel Link® is a registered trademark of SiriusXM Radio, Inc. Ultrasuede® is a registered trademark of Toray Industries, Inc. Yelp® is a registered trademark of Yelp, Inc. Ascent, DriverFocus, and StarDrive, are trademarks of Subaru of America, Inc. Added Security, Crosstrek, Forester, Outback, StarTex and XV Crosstrek are registered trademarks of Subaru of America, Inc. BRZ, Confidence in Motion, EyeSight, Impreza, Lineartronic, Legacy, S209, Subaru, SUBARU STARLINK®, SUBARU BOXER, tS (Design), WRX, STI and X-MODE are registered trademarks of Subaru Corporation.

TABLE OF CONTENTS



PURPOSE OF THIS GUIDE

WELCOME	4
IMPORTANT SAFETY INFORMATION	4
OWNER'S RESOURCES	5
IN CASE OF EMERGENCY	6
TOWING YOUR ALL-WHEEL DRIVE SUBARU	7

ENTRY AND EXIT

KEYLESS ENTRY	8
KEYLESS ACCESS WITH PUSH BUTTON START	10
POWER REAR GATE (PRG)	12

INSTRUMENT PANEL

GETTING COMFORTABLE

SEATING	18
TILT AND TELESCOPIC STEERING COLUMN	21
POWER EXTERIOR MIRRORS ..	21
REAR VIEW MIRROR	23
POWER WINDOWS	24
CENTER CONSOLE STORAGE ..	25
POWER MOONROOF	25
CLIMATE CONTROL	26
ACCESSORY CONNECTIONS ..	34

CONTROLS

INSTRUMENT PANEL SWITCHES (LOWER LEFT)	35
--	----

AUDIO CONTROLS	35
ADVANCED ADAPTIVE CRUISE CONTROL	36
I SWITCH	36
LIGHT CONTROLS	37
TURN SIGNALS	38
WINDSHIELD WIPERS	38
REAR WINDOW WIPER	39
OVERHEAD CONSOLE	40

GAUGES AND WARNING LIGHTS

COMBINATION METER	41
WARNING AND INDICATOR LIGHTS	41

OPERATING THE VEHICLE

IGNITION SWITCH	42
PUSH-BUTTON IGNITION SWITCH	42
STARTING THE VEHICLE	42
DRIVING THE VEHICLE	43
AUTO START-STOP	44
ELECTRONIC PARKING BRAKE (EPB)	46
X-MODE®	48
TURNING OFF THE VEHICLE ..	49

REFUELING

FUEL FILLER LID	50
FUEL	50
FUEL CAPACITY	50

TABLE OF CONTENTS

PASSENGER/CARGO AREAS

FOLDING THE REAR SEATS . . .	51
CHILD SAFETY LOCKS	52
LATCH/ANCHOR	53
REAR SEAT REMINDER	54
CARGO COVER	55
SPARE TIRE	56

ENGINE COMPARTMENT

HOOD PROP.	57
2.5L ENGINE	58
2.4L TURBO ENGINE	59

ADDITIONAL SPECIFICATIONS

NEW VEHICLE BREAK-IN	60
ENGINE OIL	60
ENGINE OIL CAPACITY	60
ROOF RAIL CAPACITY	61
TRAILER TOWING CAPACITY . .	61
TIRE PRESSURE MONITORING SYSTEM (TPMS)	62

STARLINK OVERVIEW

OVERVIEW OF YOUR MULTIMEDIA SYSTEM	65
BUTTONS	67
TOUCHSCREEN	68
STEERING WHEEL CONTROLS . .	69
VOICE RECOGNITION	70

STARLINK HOME

HOME SCREEN ICONS	72
REARRANGING ICONS	73
ADDING SHORTCUTS	74

CREATING A DRIVER PROFILE

CREATING A DRIVER PROFILE . .	76
HOW TO CREATE A PROFILE . .	76

MULTIMEDIA

RADIO	80
MEDIA	82

PHONE

PAIRING A PHONE	83
MAKING A CALL	84
RECEIVING A CALL	85
TEXT MESSAGES	86

APPS

SUBARU STARLINK® IN-VEHICLE APPS	87
SUBARU STARLINK® MOBILE APP	88
MYSUBARU	90

MAPS

MAPS OVERVIEW	91
-------------------------	----

STARLINK SAFETY AND SECURITY

SAFETY AND SECURITY OVERVIEW	92
ENROLLMENT	93
MYSUBARU INTEGRATION	94
SUBARU STARLINK® WI-FI HOTSPOT	94

SETTINGS AND UPDATES

SETTINGS AND UPDATES OVERVIEW	95
SOUND	96
PHONE	97
MAPS/NAVIGATION	98
CLOCK	99

EYESIGHT

EYESIGHT® OVERVIEW	100
OPERATION	101
FUNCTIONS	101
STEERING WHEEL CONTROLS	107
EYESIGHT® ASSIST MONITOR (EAM)	109
LANE DEPARTURE WARNING AND PRE-COLLISION BRAKING SYSTEM OFF	110

DRIVER ASSIST

TECHNOLOGIES

REAR-VISION CAMERA	111
FRONT VIEW MONITOR	112
BLIND-SPOT DETECTION (BSD)/ REAR CROSS-TRAFFIC ALERT (RCTA)	112
HIGH BEAM ASSIST (HBA)	113
STEERING RESPONSIVE HEADLIGHTS (SRH)	114

TABLE OF CONTENTS

REVERSE AUTOMATIC BRAKING
(RAB) 114

DRIVERFOCUS DISTRACTION MITIGATION SYSTEM

DRIVERFOCUS® OVERVIEW .. 115
DRIVERFOCUS®
COMPONENTS..... 115
DROWSY/INATTENTIVE
WARNINGS..... 117
DRIVER PROFILE/CONVENIENCE
SETTINGS..... 117
DRIVER MONITORING SYSTEM
OFF..... 119

CARE AND LIMITATIONS

STEREO CAMERA
PRECAUTIONS..... 120
WINDSHIELD GLASS AND
DASHBOARD 120

FRONT VIEW

OUTBACK..... 121

EYESIGHT DISCLAIMER

EYESIGHT® DISCLAIMER 122

HOW TO APPENDIX

HOW TO OVERVIEW..... 123
SETTING THE CLOCK 123
MEMORY HEIGHT 128
MEMORY DRIVER'S SEAT 129
BLUETOOTH® PAIRING 130
ANDROID AUTO™ 136
APPLE CARPLAY® 137
WI-FI 139
MAPS 142
FIRMWARE AND SOFTWARE
UPDATES 161

INDEX 162

PURPOSE OF THIS GUIDE

WELCOME

Congratulations on choosing a Subaru Outback and welcome to the Subaru family!

Subaru is more than a car company™. We are committed to making the world a better place, and the Subaru Love Promise is our vision to show love and respect to all people at every interaction with Subaru. We believe in building lifelong relationships with our customers, earning your trust and exceeding your expectations by providing customer service with integrity and compassion.

This Getting Started Guide will introduce you to your new Subaru Outback by providing information on the basic operation and key features of your Subaru as well as the STARLINK® and EyeSight® systems in your vehicle.

IMPORTANT SAFETY INFORMATION

The Getting Started Guide is not intended as a substitute for the Owner's Manuals. We strongly encourage you to review the vehicle, STARLINK®, and EyeSight® Owner's Manuals to ensure complete understanding.

As part of routine maintenance and continuous improvement, Subaru releases updates to the firmware and software in your vehicle. Following the installation of these updates, the screens and menus in your vehicle may differ from what appears in this guide.

 For the most current information on firmware and software updates, please refer to the "Owner's Resources" in the following section or contact your Subaru Retailer.

PURPOSE OF THIS GUIDE

OWNER'S RESOURCES

If you're having difficulty using any of the functions outlined in this guide, or to learn more, you can get more information from the following sources:

Your Subaru Owner's Manuals:

Located in the glovebox

Online Subaru Owner's Resources:

www.subaru.com/owners

Subaru Customer Support:

www.subaru.com/customer-support

1-800-782-2783 (1-800-SUBARU3)



Scan to learn more about **Owner's Resources**.



Scan to learn more about **Customer Support**.



Scan to get the **MySubaru** App.



Scan to get the **SUBARU STARLINK®** App.

PURPOSE OF THIS GUIDE

IN CASE OF EMERGENCY

SUBARU STARLINK® Safety and Security (subscription required)

SOS Emergency: Press the red “SOS” button on the overhead console in the event of an emergency to speak with a SUBARU STARLINK® Customer Care Advisor.

Enhanced Roadside Assistance: Press the blue “i” button on the overhead console or select the “Roadside Assistance” option in the “MySubaru” menu on the multimedia system.

 For more information, please refer to “Safety and Security Overview” on page 92 or the SUBARU STARLINK® Safety and Security Owner’s Manual.



SOS and Roadside Assistance Buttons

Subaru Roadside Assistance

Subaru Roadside Assistance:
1-800-261-2155

Subaru Roadside Assistance is free and standard on your Subaru; there are no forms to complete. This service is available anytime during the 3-year/36,000-mile Subaru Limited Warranty, whichever comes first. See your retailer for details and refer to the Roadside Assistance guide in the owner’s information kit for the details on this coverage. A Subaru Roadside Assistance decal has been affixed to the driver’s door window.

Roadside assistance helps with:

- Towing to the nearest authorized Subaru retailer if you cannot safely drive your Subaru
- Jump-start if your battery is dead
- Gasoline delivery if you run out of gas
- Flat tire change to install your spare
- Emergency lockout service
- National Subaru retailer locator service, with phone numbers and location of the nearest retailer anywhere in the U.S. or Canada

NOTE: Specifically excluded from Subaru Roadside Assistance coverage are service requests or claims resulting from: accidents, vandalism, acts of God, violation of any laws, or vehicle modifications not recommended by the manufacturer.

PURPOSE OF THIS GUIDE

TOWING YOUR ALL-WHEEL DRIVE SUBARU

Since Subaru Symmetrical All-Wheel Drive distributes power to all four wheels, improper towing may damage your AWD system. The best way to tow your Outback is with a flatbed truck by your Subaru retailer or a commercial towing service.

ENTRY AND EXIT

KEYLESS ENTRY

1 Lock/Arm

- Press the lock/arm button to lock the doors, the rear gate, and the fuel door and to activate the security alarm. A chirp sounds and the hazard warning lights flash once.
- If any of the doors or the rear gate are not fully closed, five rapid chirps sound and the hazard warning lights will flash to alert you.
- Press the lock/arm button three times to activate the vehicle finder function. If you are within 30 feet of your Subaru, the horn sounds once, and the hazard warning lights flash three times.

2 Unlock/Disarm

- Press the unlock/disarm button once to unlock the driver's door and fuel door. To unlock all the doors and the rear gate, briefly press the button twice. Two chirps sound and the hazard warning lights flash twice.
- The interior lights will illuminate when you press the unlock/disarm button if they are set to the "DOOR" position on the overhead console.

3 Rear Gate

- Press the rear gate button to unlock the rear gate.
- If your Subaru has a Power Rear Gate, press and hold this button to open or close the rear gate.

4 Panic Alarm

- Press the panic alarm button to sound the horn and flash the hazard warning lights.
- Press any button on the access key fob or transmitter to deactivate the panic alarm.



Transmitter



Access Key Fob

Automatic Door Locking/Unlocking

This feature allows you to set when your Subaru automatically locks or unlocks the doors through the STARLINK® Touchscreen (select “Settings”, then “Car”). The available settings are listed in the table below.

	AVAILABLE SETTINGS			
AUTO DOOR LOCK	Vehicle Speed (12 mph)	Shift into or out of PARK	OFF	
AUTO DOOR UNLOCK	Shift into or out of PARK	Ignition OFF	Driver's Door Open	OFF

ENTRY AND EXIT

KEYLESS ACCESS WITH PUSH BUTTON START

(if equipped)

The Keyless Access with Push-Button Start system features touch-activated door locking or unlocking and push-button start functions without the key ever leaving your pocket or purse. You can customize the touch-activated door locking or unlocking settings using the STARLINK® Touchscreen by selecting “Settings” then “Car”.

Unlocking Using Door Handles

Grip the driver’s door handle to unlock the driver’s door (or all doors depending on the setting). Grip the front passenger’s door handle to unlock all doors and the rear gate. Two chirps sound and the hazard warning lights flash twice.

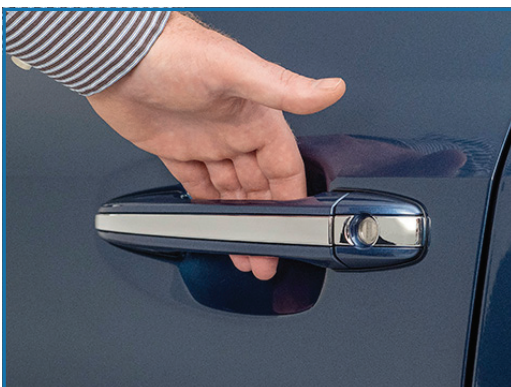

Door Unlock Sensor

Locking Using Door Handles

Close all the doors and the rear gate and touch the door lock sensor (two lines) on either front door handle. All doors and the rear gate lock. One chirp sounds and the hazard warning lights flash once.



Door Lock Sensor

Unlocking Using the Rear Gate

Press the rear gate opener button to unlock and open the rear gate (or also unlock all doors depending on the setting). Two chirps sound and the hazard warning lights flash twice.



Rear Gate Opener Button

Locking Using the Rear Gate

Close all the doors and the rear gate and press the rear lock button. All doors and the rear gate lock. One chirp sounds and the hazard warning lights flash once.



Rear Lock Button

ENTRY AND EXIT

POWER REAR GATE (PRG) (if equipped)

The Power Rear Gate allows automatic opening even when your arms are full, and a single touch on the gate button lets it close and lock the entire vehicle. The opening height can also be adjusted for spaces where clearance is limited.

Power Rear Gate Button

Opening the Power Rear Gate

Press and hold the Power Rear Gate Button on the instrument panel to automatically open the rear gate. Two chirps sound and the hazard warning lights flash twice.

Stopping the Power Rear Gate

If you briefly press the Power Rear Gate Button while the rear gate is opening, it will stop. Press and briefly hold the button again to close the rear gate.



Power Rear Gate Button

Closing the Power Rear Gate

Press and hold the Power Rear Gate Button on the instrument panel to close the rear gate. If you briefly press the button while the rear gate is closing, it will open.

The operation is the same using the Power Rear Gate Button on the access key fob or transmitter.

NOTE: This button only functions to open the PRG when the doors are unlocked. If the doors are locked, you will hear three rapid beeps from the vehicle.

From the Rear of the Vehicle

Opening the Power Rear Gate

To open the rear gate, briefly press the Rear Gate Opener Button on the underside trim near the license plate, and the rear gate automatically opens.



Rear Gate Opener Button

Stopping the Power Rear Gate

If you briefly press the Power Rear Gate Close Button on the inside edge of the rear gate while the gate is opening, it will stop. Press the button again to close the rear gate.

Closing the Power Rear Gate

To close the rear gate, briefly press the Power Rear Gate Close Button on the inside edge of the rear gate. If you press the button while the gate is closing, it will open.



Power Rear Gate Close Button

ENTRY AND EXIT

Power Rear Gate Lock

Press the lock button on the inside edge of the rear gate. The Power Rear Gate will close, and all doors, the rear gate, and the fuel lid will lock.



Power Rear Gate Close and Lock Button

Hands-free Power Rear Gate

The Hands-free Power Rear Gate allows automatic opening even when your arms are full. Using the Subaru emblem, you can open the rear gate without even touching your Outback.

The Hands-free function operates when the ignition is OFF and you are carrying the access key fob. To open the Power Rear Gate with the Hands-free function:

1. Hold your hand or arm over the Subaru emblem on the rear gate, without touching it, until a chirp sounds.
2. Immediately after the chirp sounds, move your hand away.
3. The rear gate opens automatically.



ENTRY AND EXIT

The Hands-free Power Rear Gate function can be turned ON/OFF by pressing the Hands-free Power Rear Gate OFF button on the instrument panel. It may be helpful to turn this function off when washing your Outback or attaching a trailer or carrier.

 The Power Rear Gate also comes equipped with a memory height function, allowing you to set the where the Power Rear Gate stops when it opens. For step by step instructions on setting the memory height, please refer to page 128.



INSTRUMENT PANEL

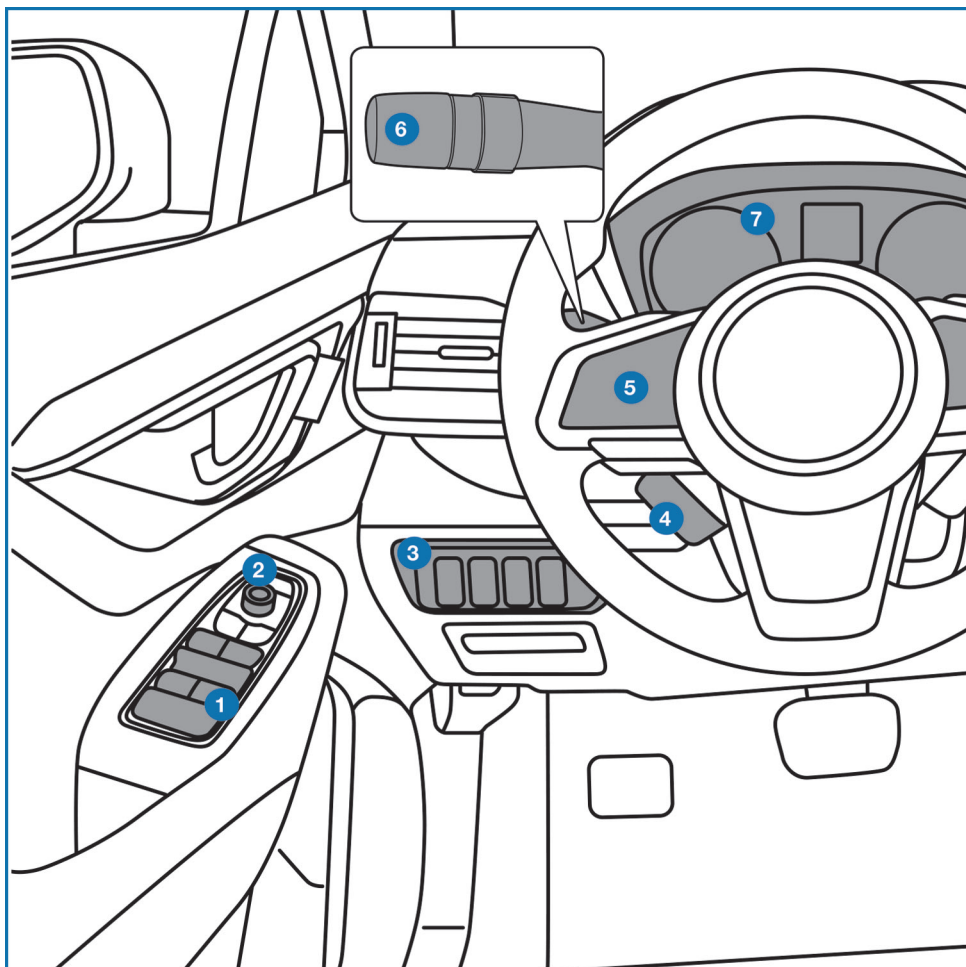

- ① Power Windows (p. 24)
- ② Power Exterior Mirrors (p. 21)
- ③ Instrument Panel Switches (p. 35)
- ④ I Switch (p. 36)
- ⑤ Audio Controls (p. 35)
- ⑥ Light Controls (p. 37)
- ⑦ Combination Meter (p. 41)

INSTRUMENT PANEL

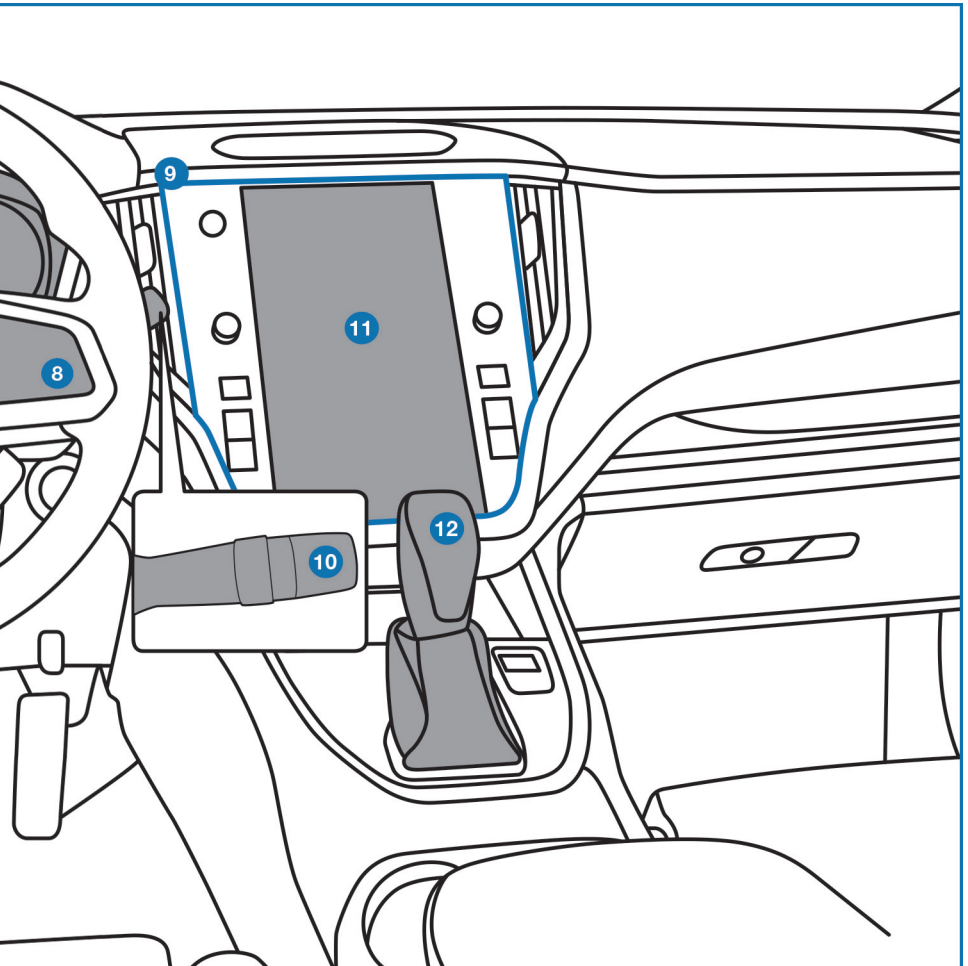

- ⑧ Advanced Adaptive Cruise Control (p. 36)
- ⑨ Center Information Display (CID) (p. 66)
- ⑩ Windshield Wipers (p. 38)
- ⑪ SUBARU STARLINK® Multimedia Touchscreen (p. 65)
- ⑫ CVT Select Lever (p. 43)

GETTING COMFORTABLE

SEATING

Manual Seats

- 1 Forward/Backward:** Pull the lever below the seat up and slide the seat forward or backward. Release the lever and make sure the seat is locked into place.
- 2 Seat Height (Driver's Seat):** Pulling up or pushing down on the lever will raise or lower the seat cushion.
- 3 Recline Seatback:** Pull the lever up to adjust the seatback. Release the lever and make sure the seatback is locked into place.



Manual Seat Levers

GETTING COMFORTABLE

Power Driver's Seat (if equipped)

- 1 Seat Position:** Moving the switch forward or backward will adjust the seat in that direction. Pulling up or pushing down on the back of the switch will adjust the seat height up or down. Pulling up or pushing down on the front of the switch will adjust the angle of the seat cushion.
- 2 Recline Seatback:** Moving the top of the switch forward or backward will adjust the angle of the seatback.
- 3 Lumbar Support:** Pressing the front of the switch will increase support. Pressing the rear of the switch will decrease support.
- 4 Thigh Extension (if equipped):** Pull up on the lever below the seat cushion to adjust the length.



Power Seat Controls



Thigh Extension

GETTING COMFORTABLE

Head Restraint Adjustment

Pull the head restraint up to raise it. To lower the head restraint, push it down while pressing the release button on the top of the seatback. Each head restraint should be adjusted so that the center of the head restraint is closest to the top of the occupant's ears.

The angle of the front head restraints can be adjusted by tilting them forward. You will hear a click when the restraint locks in place. Pulling the head restraint as far forward as it will go allows it to return to the fully upright position.



Release Button and Head Restraint Adjustment

Seatbelt Adjuster

To keep yourself comfortable and safe, always position the seatbelt adjuster so the shoulder belt passes over the middle of your shoulder without touching your neck. Press and hold the top of the adjuster and slide it up or down. Release the adjuster and make sure it is locked in place.



Seatbelt Adjustment Tab

GETTING COMFORTABLE

TILT AND TELESCOPIC STEERING COLUMN

You can adjust both the height and lengthwise position of the steering wheel. Pull the lever on the side of the steering column down firmly to unlock, then adjust the position of the steering wheel. Push the lever firmly back up to lock the steering column in place.



Steering Column Unlock

POWER EXTERIOR MIRRORS

The power mirror knob works with the ignition in the “ON” or “ACC” position. Turn the knob to “L” (left side) or “R” (right side) to select a mirror. Push the knob in the direction you want to move the mirror. Turn the knob back to the center position when finished.



Power Mirror Knob

GETTING COMFORTABLE

Power Folding Mirrors (if equipped)

The Power Folding Mirrors make it easy to protect your exterior mirrors when your Subaru is parked or being washed in an automated car wash. Press the switch to fold the exterior mirrors and press again to unfold. The switch works with the ignition in the "ON" or "ACC" positions or for about 45 seconds after shutting off the vehicle.

NOTE: Always ensure the mirrors are unfolded before driving.



Power Folding Mirror Switch

If equipped, the power folding mirrors can also be set to automatically fold in and out. On the Center Information Display, select "Settings", then "Car". Select "Door Mirror Setting" to turn on or off the Auto Electric Folding function.



GETTING COMFORTABLE

Reverse Tilt Mirror (if equipped)

The passenger side mirror can be set to automatically tilt down when you move the select lever to the "R" position, giving better visibility when backing up. The mirror returns to its normal position a few seconds after you move the select lever out of the "R" position. This setting can also be turned on or off in "Door Mirror Setting" in the Center Information Display.



REAR VIEW MIRROR

Auto-dimming Mirror (if equipped)

The auto-dimming function senses distracting glare during nighttime driving and automatically dims to eliminate the glare and preserve your vision. Press the switch to turn auto-dimming on or off. A green LED indicator on the switch illuminates when the function is on.



GETTING COMFORTABLE

HomeLink® 5 Accessory Mirror (if equipped)

The HomeLink® 5 accessory mirror provides three buttons to replace devices such as garage door openers, gate openers, entry door locks, security systems, and home lighting. The Owner's Manual provides programming instructions, and www.subaru.com/homelink has a helpful "how to" video.



NOTE: HomeLink® 5 may not be compatible with some older door openers or additional equipment may be required.



Scan to learn more about HomeLink®.

POWER WINDOWS

To open or close a window, partially press down or pull up and hold the corresponding switch. The front windows have a one-touch auto up/down function, and the rear windows may also have auto up/down function, if equipped. Fully press down or pull up and release to automatically open or close a one-touch window.



Power Window Switches

CENTER CONSOLE STORAGE

The center console has two sections consisting of an upper tray, convenient for safely storing an iPod, cellphone, or other small quick-access items, and a larger storage compartment beneath. Use the button on the driver's side to access the upper tray and the button on the passenger side to access the lower compartment.



POWER MOONROOF (if equipped)

With the ignition in the "ON" position, you can tilt or slide the moonroof.

Tilting the Moonroof

- 1 With the moonroof in the fully closed position, push up, briefly hold, and release the moonroof switch to tilt the moonroof. Slide forward, briefly hold and release the switch to lay the moonroof back down.



Opening/Closing the Moonroof

- 2 **Opening:** With the moonroof in the fully closed position, slide the switch rearward, briefly hold, and release to open the moonroof. It will stop slightly before the fully-open position to reduce wind noise. Slide the switch rearward again and release to fully open it.
- 3 **Closing:** Slide the switch forward, briefly hold, and release to close the moonroof.

Sliding the moonroof switch either way while it opens or closes will pause the moonroof.

GETTING COMFORTABLE

CLIMATE CONTROL

Dual 7-Inch Automatic Climate Control

The climate control buttons appear on the lower portion of the bottom display and are similar to the 11.6 inch display.

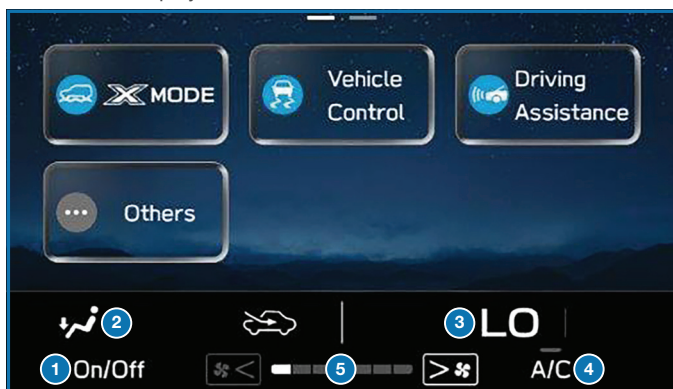

- 1 Climate Control On/Off Button
- 2 Climate Control Mode Indicator
- 3 Set Temperature Indicator
- 4 Customizable Icon
- 5 Fan Speed Indicator

Select the Climate Control Mode Indicator to see the climate control screen. On this screen you can adjust the climate control mode, airflow mode, and fan speed.



GETTING COMFORTABLE

Select the Set Temperature Indicator to adjust the temperature using the red and blue arrow buttons or the slider bar. The temperature displays at the top of the screen.

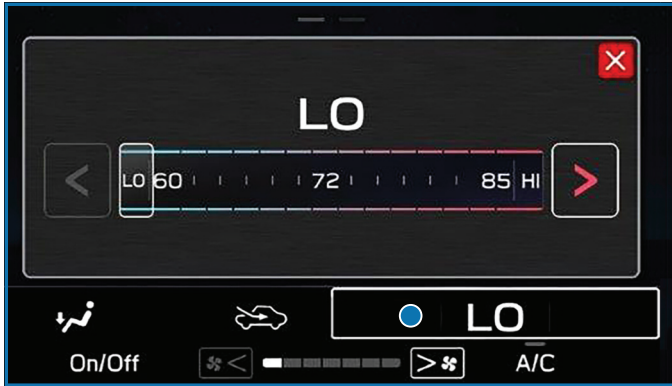

11.6-Inch Automatic Climate Control

You can set separate temperatures for the driver and front passenger. Set your desired temperature and let the system automatically make the adjustments for you. At any time, you can manually take control of the climate settings.

Operation in Automatic Mode

- 1 On/Off Button:** This button turns the climate control on and off.
- 2 Temperature Control Buttons:** Push the red arrow up button to increase the temperature or blue arrow down button to decrease the temperature. The temperature will appear on the screen. You can adjust separate temperature settings for the driver's side and passenger's side. You can also select the temperature on the screen to adjust via touch screen using the arrows or by sliding the setting bars.
- 3 Rear Window Defogger Button:** Press this button to turn on the rear window defogger. If equipped, the outside mirror defogger and windshield wiper deicer will also activate. It will automatically turn off after about 15 minutes. If the window clears before then, press the button again to turn it off. You can customize this function for continuous operation through the STARLINK® touchscreen by selecting "Settings", then "Car".









GETTING COMFORTABLE

- 4 Defroster Button:** This button turns on the front defroster. It also turns on the climate control system if it is off.
- 5 Customizable Button:** This button can be customized to be one of four different modes: A/C, Max A/C, Auto or Recirculation. On the Home Screen, select "Settings", "General", and then "Climate Control".
- 6 Climate Control Button:** Select the Climate Control Button to control fan speed, air flow, Max A/C, auto and recirculation modes.
- 7 Fan Speed Button:** Push the "Fan Up" button to increase fan speed or "Fan Down" button to decrease fan speed on the main screen. You can also select the Climate Control Button to open the climate control window to adjust fan speed. The fan speed can be adjusted from 1 to 7.
- 8 MAX A/C Button:** Press this button for quickest cooling.
- 9 Automatic Control Button:** This system automatically controls all of the climate system except defogging. Press "AUTO" to activate automatic control of everything except the fan speed. Press a second time for "Full Auto" mode to allow the system to control the fan speed as well.
- 10 Recirculated/Outside Air Button:** Press this button to prevent outside air from entering your Subaru. Press the button again to allow outside air into your Subaru.
NOTE: To prevent windshield fogging, do not remain in the recirculated mode for an extended period of time.



GETTING COMFORTABLE

- 11 Airflow Mode Selection Buttons:** Press the button to select the desired airflow mode. The selected mode air flow mode is shown on the display.

ICON	MODE	FUNCTION
	Ventilation	Instrument panel outlets
	Ventilation 2	Instrument panel outlets and less foot outlets than bi-level
	Bi-Level	Instrument panel outlets and foot outlets
	Feet	Foot outlets, both side outlets of the instrument panel and some through windshield defroster outlets
	Feet-Defrost	Windshield defroster outlets, foot outlets and both side outlets of the instrument panel
	Defrost	Windshield defroster outlets and both side outlets of the instrument panel

NOTE: The defroster button is used to activate the defrost airflow mode.

GETTING COMFORTABLE

- 12 Driver's Climate Button:** Select the Driver's Climate Button to adjust the air temperature, turn the heated/cooled seats on or off, or to SYNC (15) the passenger's side air temp with the driver's temperature.
- NOTE: The temperature bar only adjusts the air temperature, it does not adjust the seat temperature.

- 13 Driver Heated Seat Button:** Select this button to turn on the heated driver's seat. Each time you press the button, the mode will change as follows: High, Mid, Low, Off. Yellow indicators will illuminate indicating the level.

- 14 Driver Vented Seat Button:** Select this button to turn on the ventilated driver's seat. Each time you press the switch, the mode will change as follows: High, Mid, Low, Off. Blue indicators will illuminate indicating the level.

- 15 SYNC Button:** Press the button to synchronize the driver's and passenger's temperatures to the driver's temperature control dial. This will make the Driver control the master temperature control.

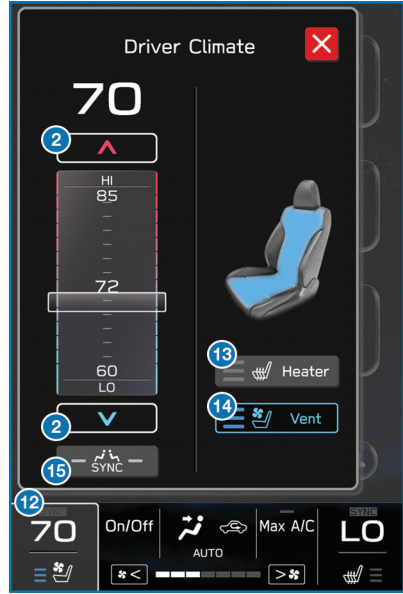

GETTING COMFORTABLE

- 16 Passengers's Climate Button:** Select the Passenger's Climate Button to adjust the air temperature, turn the heated/cooled seats on or off, or to SYNC (15) the passenger's side air temp with the driver's temperature.
- 17 Passenger Heated Seat Button:** Select this button to turn on the heated passenger's seat. Each time you press the button, the mode will change as follows: High, Mid, Low, Off. Yellow indicators will illuminate indicating the level.
- 18 Passenger Vented Seat Button:** Select this button to turn on the ventilated passenger's seat. Each time you press the switch, the mode will change as follows: High, Mid, Low, Off. Blue indicators will illuminate indicating the level.



Auto Mode

When using automatic mode, the fan speed, airflow distribution, air-inlet control and air conditioning compressor are controlled automatically. To activate:

1. Press the "AUTO" button. The "FULL AUTO" indicator light illuminates on the climate control display.
2. Set the preferred temperature using the temperature control arrows, or select the climate control button and use the touch buttons or slide bar to adjust the temperature.

If you operate any of the buttons other than "ON/OFF", rear window defogger, front defroster, "SYNC", or the temperature buttons, the "FULL" indicator light will turn off, the "Auto" will display in the screen button. You can then manually control the system as desired. Press the "AUTO" button to change back to "FULL AUTO" mode.

GETTING COMFORTABLE

Heated Seats (if equipped)

Select the driver/passenger climate button, then select the front seat heater button located on the climate control screen. There is a separate button for the driver and passenger. Each time you press the button, the mode will change as follows: High, Mid, Low, Off. Yellow indicators will illuminate indicating the level.

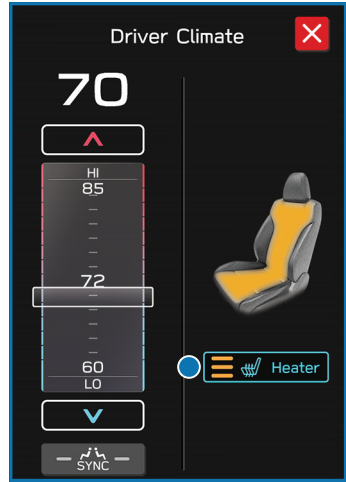

Ventilated Seats (if equipped)

Select the driver/passenger climate button, then select the ventilated seat button located on the climate control screen. There is a separate button for the driver and passenger. Each time you press the switch, the mode will change as follows: High, Mid, Low, Off. Blue indicators will illuminate indicating the level.

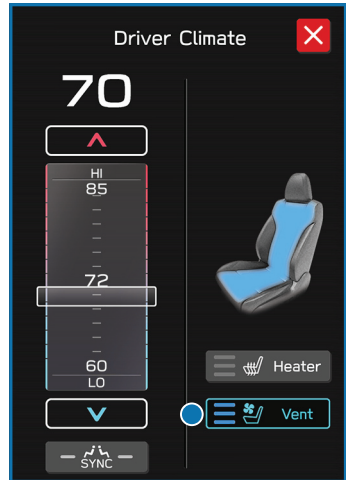

GETTING COMFORTABLE

Rear Heated Seats (if equipped)

There are separate heated seat switches for each side on the rear center console. Press the switch to activate the heated seat. The heating mode changes to High, Low, and Off each time you press the switch, and yellow indicators illuminate indicating the level.



Heated Steering Wheel (if equipped)

To activate, pull the heated steering wheel switch with the ignition in "ON" or "ACC". The indicator light on the switch will illuminate. To deactivate, pull the switch again. The heater will stay on for approximately 30 minutes.



Remote Engine Start with Climate Control



This feature can also be set through **MySubaru.com** or the **MySubaru App**



MySubaru App



MySubaru.com

You can remotely start your Subaru and adjust the temperature using the STARLINK® Safety and Security features through the **MySubaru App** (subscription required). Please refer to your SUBARU STARLINK® Owner's Manual for a list of required vehicle conditions for this feature.

GETTING COMFORTABLE

ACCESSORY CONNECTIONS

- 1 Auxiliary Input Jack:** The 3.5mm auxiliary input jack is located below the Center Information Display. You can connect a portable music player to the auxiliary jack and hear the music stored on it through your Subaru's speakers. Press the "Source" button located on the steering wheel or the "Media" button on the Touchscreen to select the auxiliary mode.



Connection Ports

- 1** For more information, please refer to page 82 or your SUBARU STARLINK® Owner's Manual.
- 2 Dual USB Ports:** The USB ports are located below the Center Information Display and, if equipped, on the center console in the rear seat area. You can connect a variety of USB-equipped devices to the front ports, such as portable music players or smartphones, to enjoy your favorite music through your STARLINK® Multimedia System. All ports provide charging (5V, 2.1A) to devices. The ports on the rear center console are for charging only.
- 1** For more information, please refer to page 82 or your SUBARU STARLINK® Owner's Manual.

Power Outlets:

Power outlets (12V) are located in the glove box, cargo area, and, if equipped, the center console. Electrical power is available for use with in-vehicle electrical appliances with a maximum power rating of 120W.

- 1** For more information, please refer to your Owner's Manual.

INSTRUMENT PANEL SWITCHES (LOWER LEFT)

The switches in the lower left of the instrument panel allow you to control convenient features. The switches include:

- 1 Power Rear Gate (p. 12)
 - 2 Illumination Brightness (p. 37)
 - 3 Hands-free Power Rear Gate OFF (p. 14)
- 📖 For more information, please refer to your Owner's Manual.



AUDIO CONTROLS

- 1 Presets/Skip
 - 2 Volume
 - 3 Source
 - 4 Voice Recognition
 - 5 Call/End
- 📖 For more information about your audio system and controls, please refer to page 69 or the SUBARU STARLINK® Owner's Manual.



CONTROLS

ADVANCED ADAPTIVE CRUISE CONTROL

- 1 Adaptive Cruise Control On/Off
 - 2 Lane Centering
 - 3 Increase Distance
 - 4 Decrease Distance
 - 5 Resume (RES)/Increase Speed and Set (SET)/Decrease Speed
- i** For more information on the Advanced Adaptive Cruise Control switches, please refer to page 107 or the EyeSight® Owner's Manual.

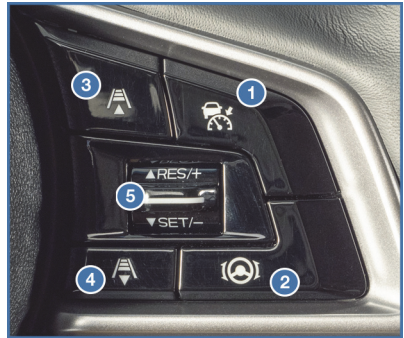

I SWITCH

The "i" switch and arrows allow you to cycle through useful driving information in the Combination Meter Display (CMD) such as fuel consumption, driving time, speed, and tire pressure, among others. You can change the information displayed by pulling the up and down arrows.

Important vehicle information or warning screens can be displayed when the "i" appears in the CMD. Pull and hold the "i" switch to access the important messages. Use the arrows to cycle through multiple messages.

- i** For more information, please refer to "Combination Meter Display" in your Subaru Owner's Manual.



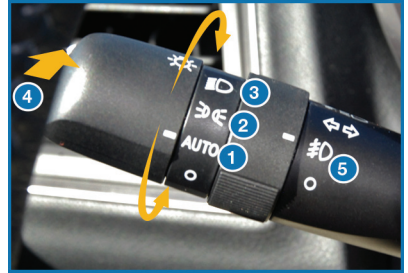

LIGHT CONTROLS

- 1 **AUTO:** Rotate the end of the lever to set your headlights to automatically turn on or off, depending on the level of light outside. NOTE: The sensitivity of the automatic headlights can be adjusted through the STARLINK® multimedia display.
- 2 **Parking Lights:** Rotate the end of the lever to turn on the instrument panel lights, parking lights, side marker lights, tail lights, and license plate lights.
- 3 **Headlights:** Rotate the end of the lever to turn on the headlights, instrument panel lights, parking lights, side marker lights, tail lights, and license plate lights.
- 4 **High Beams:** Push the lever forward to change from low beam to high beam. When set to the “AUTO” position, pushing the lever forward also activates the High Beam Assist (HBA) system. Pull the lever back to center to return to low beam.
- 5 **Fog Lights:** If equipped, rotate the dial to turn on the fog lights when the headlights are on low beams in the “” or “AUTO” position.



Illumination Brightness

When the light controls are on (in the , , or “AUTO” position), and ambient light is low, rotating the illumination brightness dial on the instrument panel upward will make the instrument panel illumination brighter. When the dial is fully rotated upward (dots aligned), the instrument panel illumination stays at full brightness. Rotating the dial downward dims the instrument panel illumination.



Illumination Brightness Dial

When the ambient light is bright, the illumination brightness is set to the maximum regardless of the position of the control dial.

CONTROLS

Daytime Running Lights

The daytime running lights automatically turn on when the engine is running, the parking brake is released, the select lever is out of the “P” position, and the light switch is set to Off, “AUTO”, or “ ☀ ”. Always turn on the headlights when it’s dark outside by rotating the dial to the “ ☀ ” or “AUTO” position.

TURN SIGNALS

Push fully up for the right turn signal and fully down for left turn signal. Your Subaru also has a one-touch lane changer feature: push slightly up and release to signal a right lane change or push slightly down and release to signal a left lane change.



WINDSHIELD WIPERS

To turn on the wipers, press the wiper control lever down one position for intermittent, two positions for low speed, or three positions for high speed. When the lever is in the intermittent position, rotate the dial to adjust the operating interval of the wipers. To turn the wipers off, return the lever to the “OFF” position. For a single wipe, move the lever up from the “OFF” position.

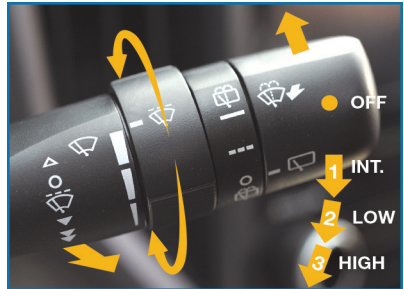

Pull the lever toward you to wash the windshield. The washer will spray and the wipers will operate while you pull the lever.

REAR WINDOW WIPER

Rotate the end of the lever up one position for intermittent, or two positions for continuous operation.

When the lever is in the intermittent position, the wiper operates at intervals corresponding with vehicle speed. When you move the select lever to the “R” position, the wiper will switch to continuous operation. It will return to intermittent when you move the select lever out of “R”.

Rotate the dial up from the continuous operation position or down from the “OFF” position to spray washer fluid. The washer will spray until you release the dial, then return to the previous position and resume operation.



Rear-vision Camera Washer

To help keep your vision clear, your Subaru comes equipped with a Rear-vision Camera Washer. To clean the Rear-vision Camera, simply use the rear window washer.

 For more information, about the Rear Vision Camera and Rear Vision Camera Washer, please refer to page 111 or your Owner's Manual.

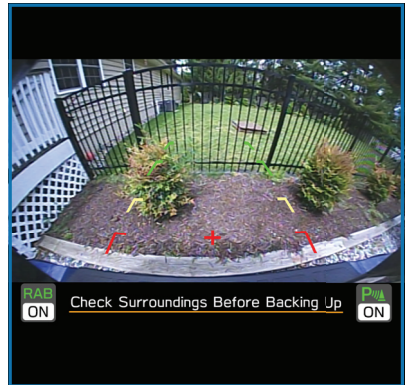

CONTROLS

OVERHEAD CONSOLE

1 SOS Emergency

Assistance: Press the red “SOS” button to connect with a SUBARU STARLINK® Customer Care Advisor (Subscription required). Press and hold the button for about two seconds to cancel the call.

1 For more information, please refer to page 92 or the SUBARU STARLINK® Safety and Security Owner’s Manual.

2 **Enhanced Roadside Assistance:** Press the blue “i” button to connect with a SUBARU STARLINK® Roadside Assistance Provider (Subscription required). Press and hold the button for about two seconds to cancel the call.

1 For more information, please refer to page 92 or the SUBARU STARLINK® Safety and Security Owner’s Manual.

3 **Automatic Illumination:** When the switch is in the “DOOR” position, the map lights illuminate when any door is opened, the doors are unlocked using the remote keyless entry system or keyless access function, or the ignition is turned from “ON” or “ACC” to “LOCK”/“OFF”.

4 **Power Moonroof Switch:** Use this switch to operate the power moonroof.

1 For more information, please refer to page 25 or your Subaru Owner’s Manual.

5 **Map Lights:** Press a map light to turn it on or off.

NOTE: The map lights can remain on even when the ignition is off, key removed from vehicle and doors are locked.



GAUGES AND WARNING LIGHTS

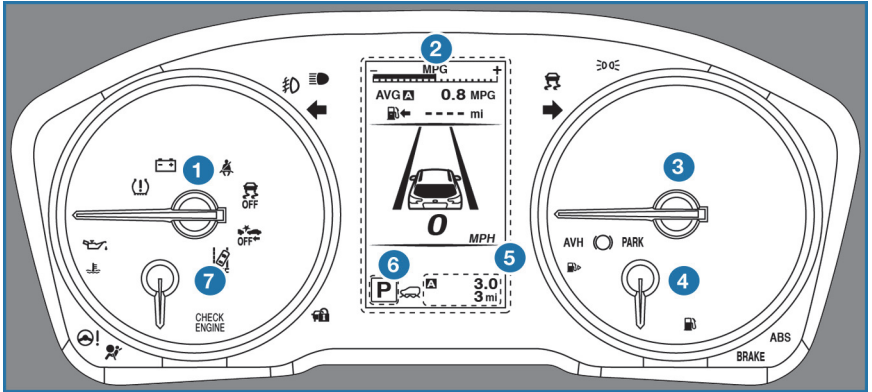

COMBINATION METER





- 1 Tachometer
- 2 Combination Meter Display (CMD)
- 3 Speedometer
- 4 Fuel gauge
- 5 Trip meter and odometer
- 6 Select lever/gear position indicator
- 7 Engine coolant temperature gauge

WARNING AND INDICATOR LIGHTS

Red lights indicate immediate attention is required. Some examples are:

	Seatbelt warning		Door open	BRAKE / !	Brake system
--	------------------	--	-----------	------------------	--------------

Yellow lights indicate caution. Some examples are:

	Low fuel		Engine oil level warning light		Tire pressure warning light
---	----------	---	--------------------------------	---	-----------------------------

Green and blue lights are for information. Some examples are:

	Headlight indicator light	AVH	Auto Vehicle Hold ON		High beam indicator light
---	---------------------------	------------	----------------------	---	---------------------------

OPERATING THE VEHICLE

IGNITION SWITCH

The ignition switch has four positions:

LOCK: You can only insert or remove the key in this position.

ACC (Accessory): Provides power to the radio and accessory power outlets.

ON: All electrical systems are available. The key returns to this position after starting the engine.

START: Turn the key to this position to start the engine.

PUSH-BUTTON IGNITION SWITCH (if equipped)

Each time you press the ignition switch without depressing the brake pedal, the ignition position will change as follows: ACC, ON, OFF.

ACC (Accessory): Provides power to the radio and accessory power outlets. Orange indicator illuminates.

ON: All electrical systems are available. Orange indicator illuminates.

OFF: Power off and indicator off.

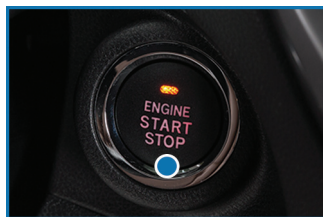

STARTING THE VEHICLE

Without Push-button Ignition

To start the engine:

1. Make sure the select lever is in the “P” position.
2. Using the key, turn the ignition switch to “START”.

NOTE: Do not depress the accelerator pedal. Release the key as soon as the engine starts.

With Push-button Ignition

To start the engine:

1. Sit in the driver’s seat with the access key fob.
2. Make sure the select lever is in the “P” position.
3. Depress the brake pedal.
4. When the Engine START/STOP button indicator turns green, briefly press and release the Engine START/STOP button.

DRIVING THE VEHICLE

Automatic Transmission Shift Mode

The Continuously Variable Transmission (CVT) is electronically controlled and provides two different driving modes: normal and manual.

Normal Mode

When the select lever is in the “D” (Drive) position, the transmission is in normal shift mode. The select lever position indicator in the Combination Meter Display (CMD) shows “D” and the transmission automatically shifts into a suitable forward gear.

Manual Mode

In manual mode, you select the desired gear position to obtain necessary acceleration and engine braking. Move the select lever left from the “D” position into the “M” position to select manual mode. The gear position indicator in the Combination Meter Display (CMD) shows the currently selected gear. Arrow-shaped indicators show when upshifting or downshifting is available. To shift, use the paddle shift control switches behind the steering wheel.



Paddle Shift Control Switches

You can shift gears using the paddle shift control switches. To upshift to the next higher gear, pull the “+” paddle on the right toward you. To downshift to the next lower gear, pull the “-” paddle on the left toward you.

You can temporarily shift gears even when the select lever is in the “D” position by pulling either the “+” or “-” paddle toward you. Once vehicle speed stabilizes, the transmission will switch back to normal mode.



OPERATING THE VEHICLE

AUTO START-STOP

The Auto Start-Stop system is designed to automatically stop and restart the engine when the vehicle is stationary for a short period of time (while waiting for a traffic light or in a traffic jam) after the engine has warmed up. The system operates in order to reduce fuel consumption, exhaust emissions and undesired idling noise.

Auto Start-Stop System ON/OFF

The Auto Start-Stop system can be turned on and off in the Center Information Display (CID) by using the Auto Start-Stop button on the Home screen.

NOTE: The system will default to ON after the vehicle has been shut off.



When the Auto Start-Stop system is turned OFF, the Auto Start-Stop OFF indicator light in the combination meter display will illuminate. This is a solid yellow indicator.



OPERATING THE VEHICLE

System Operation

So that it can be used safely and comfortably, in addition to driver operations, the Auto Start-Stop system is designed to constantly monitor the vehicle conditions as well as the environment inside and outside the vehicle, in order to control stopping and restarting of the engine.

After the vehicle has been completely stopped by depressing the brake pedal with the select lever in the “D” position, the engine will be automatically stopped.



If you release the brake pedal with the select lever kept in the “D” position, the engine will be automatically restarted.

Auto Vehicle Hold (AVH) also integrates seamlessly with Auto Start-Stop functions. With AVH, the parking brake automatically applies, so you can sit without your foot on the brake pedal. To restart the engine, just gently press down on the accelerator pedal.

If the engine is temporarily stopped by the system, the Auto Start-Stop indicator light on the combination meter will illuminate in green. This indicator light will turn off when the system restarts the engine.

There are several operating conditions for this system to operate as intended. Please refer to the Owner's Manual for further information.

Fuel Saving Display

Once the Auto Start-Stop System has stopped the engine, the Fuel Saving Display will appear in the Combination Meter Display (CMD), showing how much time the engine was off in the top line and the amount of fuel saved in the bottom line. These are the total stop time and fuel saved since the trip meter was reset.

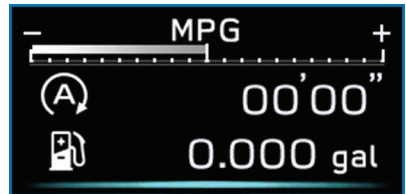

No Activity Detected Indicator Light

If the operational conditions are not met when the vehicle is stopped, the engine will not stop and the Auto Start-Stop No Activity Detected indicator light will illuminate. This indicator is solid white when illuminated. It will turn off when the vehicle begins to drive.



OPERATING THE VEHICLE





Auto Start-Stop Warning Light

The Auto Start-Stop warning light will illuminate in yellow when initially turning the ignition switch to the “ON” position. The light will turn off after the engine has started.



NOTE: If the Auto Start-Stop warning light does not turn off or is flashing yellow after the engine has started, the Auto Start-Stop system may be malfunctioning.

We recommend that you contact your authorized SUBARU Retailer for an inspection.

INDICATOR	PATTERN	CONDITION
	Solid green	This indicator light illuminates when the engine has been temporarily stopped by the Auto Start-Stop system. It will turn off when the engine is restarted.
	Solid White	Operational conditions have not been met, the engine will not stop and this light will illuminate. The light goes out once the brake pedal is released.
	Solid Yellow	This light indicates that the system has been turned off. The light will turn off once the system is turned back on.
	Flashing Yellow	A fault has been detected with the Start-Stop system. Please contact your authorized Subaru Retailer.

ELECTRONIC PARKING BRAKE (EPB)

To apply the parking brake, depress the brake pedal and pull up the parking brake switch. The indicator light on the parking brake switch will illuminate and “PARK” will appear in the Combination Meter.

To release the parking brake manually, depress the brake pedal and push the parking brake switch down. To automatically release the parking brake, gently press the accelerator pedal with the select lever in the “D” or “R” position.



NOTE: Automatic parking brake release will not work unless all the doors are closed and your seatbelt is fastened.

OPERATING THE VEHICLE

Auto Vehicle Hold (AVH)

Auto Vehicle Hold gives your feet a break by automatically holding your Subaru in place when at a complete stop, such as at a traffic signal, even after you release the brake pedal.

To turn on Auto Vehicle Hold:

- 1 On the Home screen select the “Car Settings” icon.
- 2 In the “Vehicle Control” menu, select “Auto Vehicle Hold”. The AVH indicator will illuminate in the combination meter.



While your Subaru is being held by this function, the operation indicator in the combination meter will illuminate. The function is canceled when you depress the accelerator pedal or the brake pedal.

Select “Auto Vehicle Hold” again to turn it off. The function works with the select lever in either the “D” or “R” position.

NOTE:

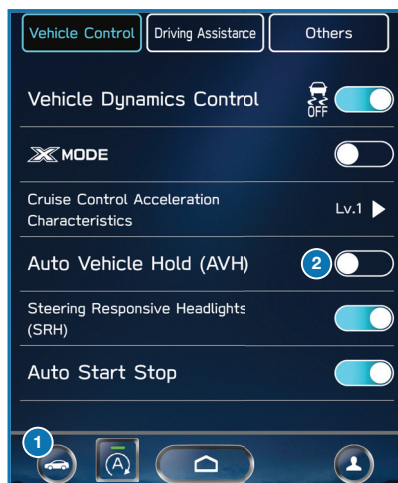
- For this system to work your seatbelt must be fastened.
- Make sure to turn off this function before entering an automatic car wash.



ICON	MODE
	Auto Vehicle Hold ON
	Auto Vehicle Hold IN OPERATION

OPERATING THE VEHICLE

X-MODE®

X-MODE® is the integrated control system of the engine, All Wheel Drive, and Vehicle Dynamics Control (VDC) systems for driving with bad road conditions. Using X-MODE®, you can drive more comfortably even in slippery road conditions, such as mud or snow, including uphill and downhill.

You can activate the system when the vehicle speed is less than 12 mph. When X-MODE® is active, the Driving Statistics screen shows the steering direction, vehicle angle and power distribution. If the vehicle speed reaches 25 mph while X-MODE® is active, the system is cancelled.

Activating X-MODE®

X-MODE® can be quickly turned on or off in the Information Bar. Use the arrow button to navigate to X-MODE® and select the setting.

You can also turn X-MODE® on or off in the Vehicle Control Menu, giving you access to other important vehicle functions as well:

- 1 Select the "Car Settings" icon.
- 2 In the "Vehicle Control" menu, select "X-MODE®" to turn the function on or off.

In certain situations, such as navigating a vehicle stuck in mud or snow, it may be helpful to allow more wheel spin by turning off the Vehicle Dynamics Control system:

- 3 In the "Vehicle Control" menu, select "Vehicle Dynamics Control OFF".

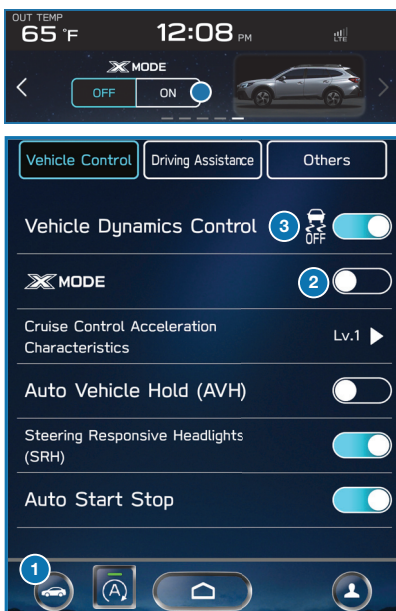
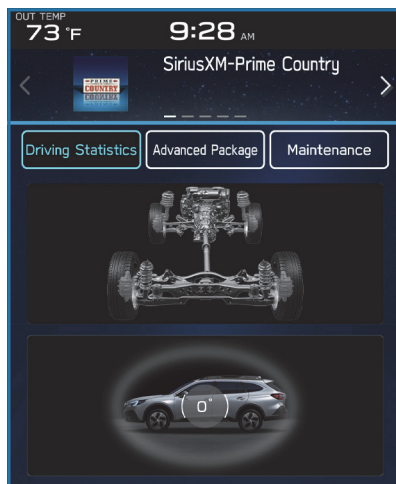

OPERATING THE VEHICLE

For vehicles with an X-MODE® Dual Mode System, select NORMAL, SNOW/DIRT or DEEP SNOW/MUD:

- SNOW/DIRT is suitable for driving on slippery road surfaces such as snow or gravel, where the points of contact between the tires and road surface are visible.
- DEEP SNOW/MUD provides maximum torque from the engine and the optimal amount of slip in the driving wheels, enabling the vehicle to free itself more effectively. It is suitable for driving on a roads where the tires can become buried, such as deep snow, dry sand, or muddy roads.

Hill Descent Control (HDC)

This function helps maintain a constant vehicle speed when driving down steep hills or declines. HDC is automatically engaged with X-MODE® and functions with the select lever in the “D” or “R” position.

TURNING OFF THE VEHICLE

Without Push-button Ignition

To stop the engine:

1. Stop your Subaru completely.
2. Move the select lever to the “P” position.
3. Turn the ignition switch to “OFF”.

NOTE: The front windows will remain active for about 40 seconds and the SUBARU STARLINK® Multimedia System will remain on for about three minutes or until a door is opened, whichever occurs first.

With Push-button Ignition

To stop the engine:

1. Stop your Subaru completely.
2. Move the select lever to the “P” position.
3. Press the ignition switch.

NOTE: The front windows will remain active for about 40 seconds and the SUBARU STARLINK® Multimedia System will remain on for about three minutes or until a door is opened, whichever occurs first.

REFUELING

FUEL FILLER LID

The fuel filler lid is located toward the rear of the passenger side. To open the lid:

1. Make sure your Subaru is stopped and the select lever is placed in PARK. Then turn the ignition to the "LOCK"/ "OFF" position.
2. The fuel filler lid is automatically unlocked when the ignition is moved to the "LOCK"/"OFF" position, or by unlocking using the access key fob/transmitter or door handles.
3. Push the rear side of the lid.
4. When the lid opens slightly, open it further by hand.

While refueling, place the fuel filler cap on the cap holder inside the lid.

After refueling, put the cap back on and turn it clockwise until you hear a clicking noise. Be certain not to catch the tether under the cap while tightening.

To close the lid, press it until you hear it latch.

NOTE: If the fuel filler cap is not tightened until it clicks or if the tether is caught under the cap, the Check Engine warning light may illuminate.



Fuel Filler Lid and Cap

FUEL

Use regular unleaded gasoline with an octane rating of 87 AKI or higher. Do not use fuels with more than 10% ethanol for 2.5 L models or 15% ethanol for 2.4 L models.

 For more information, please refer to the Owner's Manual.

FUEL CAPACITY

	Capacity
Full Fuel Tank	18.5 US gallons
Low Fuel Warning Light	2.6 US gallons

PASSENGER/CARGO AREAS

FOLDING THE REAR SEATS

The rear seats can be folded down from the back seat or from the cargo area.

First, lower the headrests. Then, push the release button until you see the red around the button and fold down the seats. To return the seatback to its original position, raise the seatback until it locks into place. You will no longer be able to see the red when the seat is locked.

Release latches are located on either side of the cargo area. Pull the release latch on the seat side that you want to fold down.

You can also recline the rear seats by pulling up on the lever on the side of the seat and pushing back.

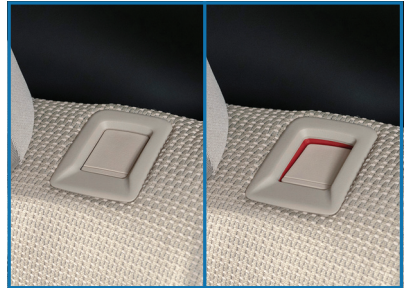

PASSENGER/CARGO AREAS

CHILD SAFETY LOCKS

The child safety locks are located on the inside edges of the rear doors. In the locked position, the rear doors can only be opened from the outside.



PASSENGER/CARGO AREAS

LATCH/ANCHOR

Your Subaru is equipped with Lower Anchors and Tethers for Children (LATCH). For maximum safety, first carefully read the LATCH system instructions from the device manufacturer, as well as the installation instructions in your Owner's Manual, to properly install the LATCH compatible restraint system. Use the appropriate seatbelts or anchorages provided in your Subaru. Children age 12 and under must properly occupy the rear seat at all times.

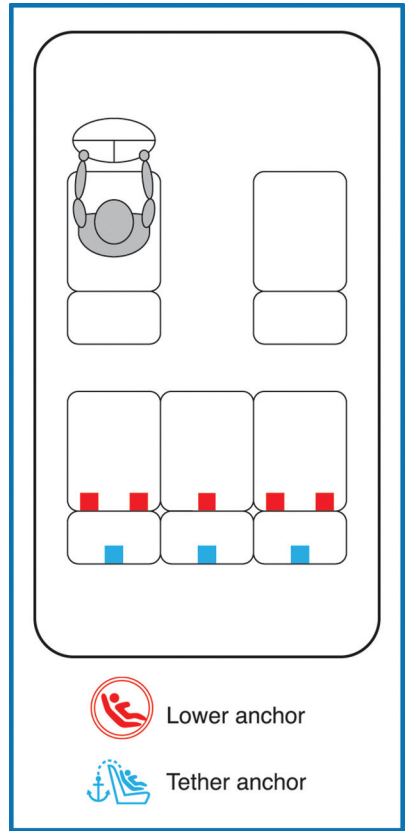

PASSENGER/CARGO AREAS

REAR SEAT REMINDER

The Rear Seat Reminder system assists you in preventing a child or pet from being left in your Subaru. The system monitors the opening and closing of the rear side door. It does not physically sense the presence of a child or pet.

The system turns on if your Subaru is started within 30 minutes of a rear side door opening or closing. It also turns on if a rear side door is opened and closed when your Subaru is running and stationary. The system remains on if your Subaru is turned off and back on again within 30 minutes and the rear side doors remained closed.

When you turn your Subaru off, the system warns you audibly and with a “Reminder, Look In Rear Seat” message in the Combination Meter Display (CMD).

The system operates only one time with each ignition cycle and opening and closing of a rear side door. You can turn the Rear Seat Reminder off with the touchscreen by selecting “Settings”, then the “Car” menu.

Passenger Occupant Detection and Seatbelt Reminders

To help keep your passengers safe, your Subaru has a passenger occupant detection and seatbelt reminder system for each seat, including the rear seats.

If passengers in the rear seats do not fasten their seatbelts while the ignition is in the “ON” position, the seatbelt warning lights illuminate or blink for the specific seat, and a warning chime may sound.

 For more information, please refer to “Seatbelt Warning Light and Chime” in your Subaru Owner’s Manual.

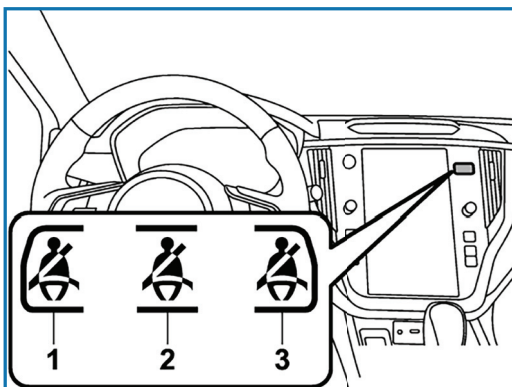

PASSENGER/CARGO AREAS

CARGO COVER (if equipped)

The cargo cover is provided to cover the cargo area and to protect its contents from direct sunlight. It has an easy lift-up function, eliminating the need to rewind the cover all the way when accessing the cargo. The cover can also be detached to make room for additional cargo.

Hold the cover by the handle in the center, tilt it up and pull it out to extend the cover. Then insert the stoppers into the catches.

To lift the cover to access cargo, pull down the handle in the center to release the stoppers from the catches, and allow the stoppers to slide up the grooves.

Store the cover under the floor of the cargo area when not in use. Instructions for operation are included on the cargo cover housing.



Cargo Area and Cover

PASSENGER/CARGO AREAS

SPARE TIRE

The jack and other maintenance tools are stored in the tool bucket on top of the spare tire. Remove the tools to access the spare tire.

 For more information, please refer to your Owner's Manual.



ENGINE COMPARTMENT

HOOD PROP

The hood prop is located on the left underside of the hood. Release it from the retainer and insert the end into the slot marked with an arrow.

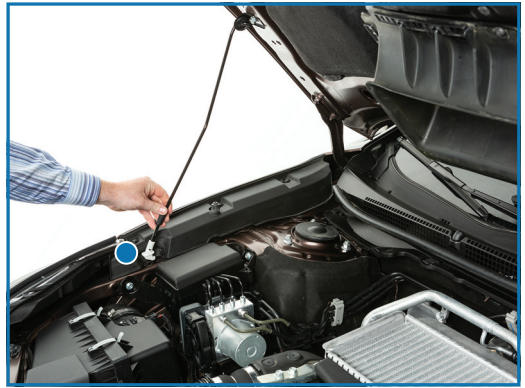

ENGINE COMPARTMENT

2.5L ENGINE

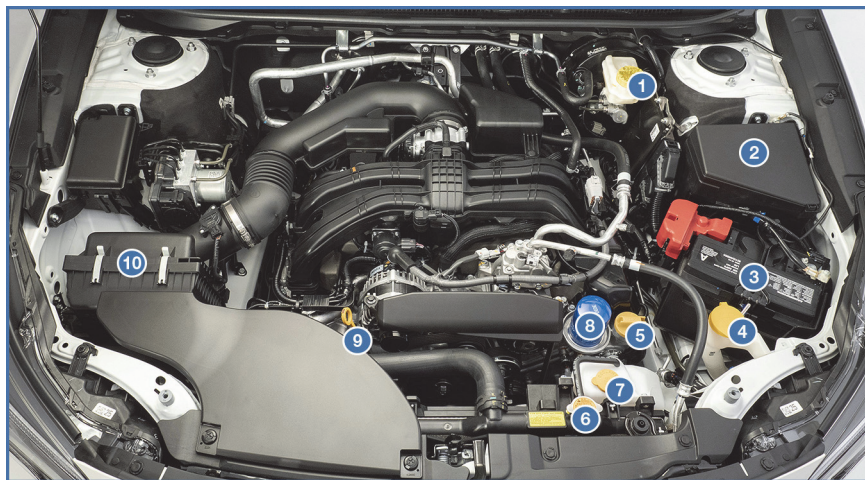

- | | |
|--------------------------|----------------------------|
| 1 Brake Fluid Reservoir | 6 Radiator Cap |
| 2 Main Fuse Box | 7 Engine Coolant Reservoir |
| 3 Battery | 8 Engine Oil Filter |
| 4 Windshield Washer Tank | 9 Engine Oil Dipstick |
| 5 Engine Oil Filler Cap | 10 Air Cleaner Element |
- ⓘ Please refer to the Warranty and Maintenance Booklet for recommended replacement intervals.

ENGINE COMPARTMENT

2.4L TURBO ENGINE



- 1 Brake Fluid Reservoir
 - 2 Main Fuse Box
 - 3 Battery
 - 4 Windshield Washer Tank
 - 5 Engine Oil Filler Cap
 - 6 Radiator Cap
 - 7 Engine Coolant Reservoir
 - 8 Engine Oil Filter
 - 9 Engine Oil Dipstick
 - 10 Air Cleaner Element
- 1 Please refer to the Warranty and Maintenance Booklet for recommended replacement intervals.

ADDITIONAL SPECIFICATIONS

NEW VEHICLE BREAK-IN

The performance and long life of your Subaru are dependent on how you handle and care for your Subaru while it is new.

Follow these instructions during the first 1,000 miles:

- Do not race the engine.
- Do not drive at one consistent engine or vehicle speed, either fast or slow.
- Avoid starting suddenly and rapid acceleration, except in an emergency.
- Avoid hard braking, except in an emergency.

ENGINE OIL

Use 0W-20 synthetic, with one of the following specifications:

- API classification SN or SN PLUS with the words "RESOURCE CONSERVING".
- ILSAC GF-5, which can be identified with the ILSAC certification mark (Starburst mark).

ENGINE OIL CAPACITY

Engine	Capacity (during oil and filter change)
2.5L Model	4.4 US quarts
2.4L Model	4.8 US quarts

When the level is at the "low" mark, add approximately 1 quart of engine oil in through the filler cap to bring the oil level to the "full" mark. For filler cap location see the engine compartment on page 58 or page 59.

- 1 Full Level
- 2 Low Level

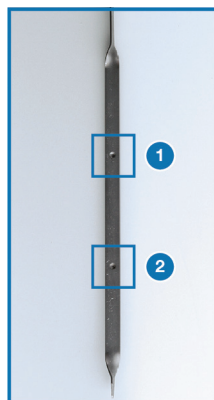

ADDITIONAL SPECIFICATIONS

ROOF RAIL CAPACITY

CROSS BARS DYNAMIC	ROOF RAILS DYNAMIC	ROOF RAILS STATIC
150 Pounds	176 Pounds	176 Pounds

 For more information, please refer to your Owner's Manual.

TRAILER TOWING CAPACITY

2.5L Models	
Maximum total trailer weight*	Maximum tongue weight*
2,700 pounds	270 pounds

2.4L Models	
Maximum total trailer weight*	Maximum tongue weight*
3,500 pounds	350 pounds

*Towing a trailer with brakes.

NOTE:

- For models equipped with the BSD (Blind Spot Detection) and RCTA (Rear Cross Traffic Alert) driving support systems, when towing a trailer, it may be necessary to select "BSD/RCTA" to deactivate the system. The system may not operate as expected due to obstruction of the radar waves. For details about how to turn BSD/RCTA off, refer to page 113 and/or your Owner's Manual.
- For models equipped with the RAB (Reverse Automatic Braking) driving support system, when towing a trailer, it may be necessary to press the RAB button to deactivate the system. The system may not operate as expected due to obstruction of the sonar waves. For details about the RAB button, refer to page 114 and/or your Owner's Manual.

 Please refer to your Owner's Manual for complete details, especially if you plan to use this vehicle for regular towing.

ADDITIONAL SPECIFICATIONS

TIRE PRESSURE MONITORING SYSTEM (TPMS)

Your Subaru has a Tire Pressure Monitoring System (TPMS). Individual tire pressure can be found in the Combination Meter Display. Use the “i” switch arrows to display the TPMS screen.

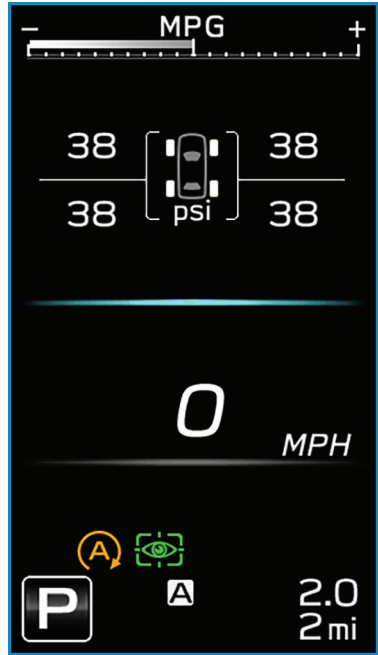

TPMS Screen

ADDITIONAL SPECIFICATIONS

Tire pressure specification is listed on the tire specification placard located on the driver's side door pillar.



Tire Specification Placard

ADDITIONAL SPECIFICATIONS

The tire pressure can be changed from kPa to PSI by using the Touchscreen.

- 1 Start by selecting the “Home” button
- 2 Select “Settings”
- 3 Select “General”
- 4 Select “Tire Pressure Units”



- 5 Select your desired setting either “PSi” or “kPa”

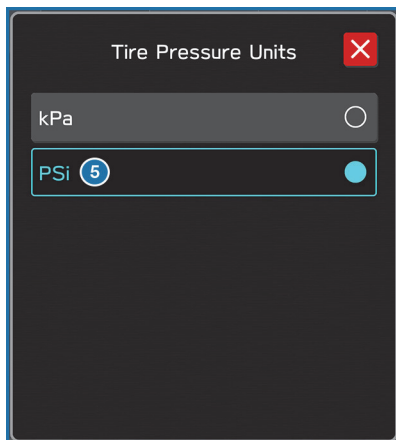

OVERVIEW OF YOUR MULTIMEDIA SYSTEM

SUBARU STARLINK® Multimedia combines the radio along with the ability to connect your phone* through Bluetooth® to the multimedia system for making calls, sending text messages and listening to your favorite songs on your phone.

As part of routine maintenance and continuous improvement, Subaru releases updates to the firmware and software in your vehicle. Following the installation of these updates, the screens and menus in your vehicle may differ from what appears in this guide.

 For the most current information, please visit www.subaru.com/owners, www.subaru.com/customer-support, or contact your Subaru Retailer. Refer to page 5 for details on these resources.

* Compatible smartphone and application required. For applications to operate, latest version of each application required. Data provided by smartphone is displayed on the Touchscreen. Some state laws prohibit the operation of handheld electronic devices while operating a vehicle. Smartphone apps should only be launched when vehicle is safely parked. Your wireless carrier's rates may apply.

Various Systems

Depending on your model and trim level there are several types of SUBARU STARLINK® Multimedia systems. Some of the functions described in this guide will vary by system.

- Dual 7.0-inch Multimedia
- 11.6-inch Multimedia Plus
- 11.6-inch Multimedia Navigation

STARLINK OVERVIEW

Screen Layout

1 Status Bar: The very top of the screen, which shows the outside temperature and clock. Tap on the clock display to adjust the time and other clock settings.

2 Information Bar: Displays the radio station or music track you're listening to or several other screens of information, including X-MODE®. If you select the arrows on the right or left, you can scroll through the information programmed to display there, customized through the "Settings" menu.

3 Home Screen: The main part of the display where maps, phone features, Apps and car information is accessed.

4 Home Buttons: Provide shortcuts to frequently used screens:

- Car Settings icon — Allows you to adjust a number of vehicle settings, even while driving
- Auto Start-Stop button — Allows you activate or deactivate Auto Start-Stop
- Home Button — Returns you to the home screen
- Driver Profile Button — Allows you to create or edit driver profiles

5 Climate Control: The bottom portion of the screen contains all the settings for climate control, including heated/vented seats. You can adjust the fan speed or airflow mode simply by selecting this area.

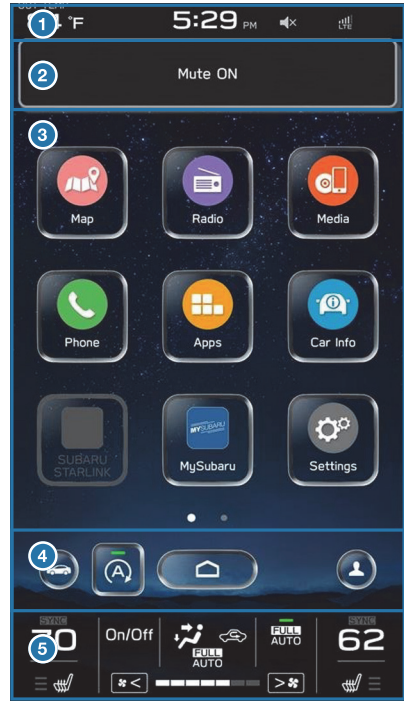

BUTTONS

- 1 Power/Volume/Mute Control:** Press the power/volume/mute control knob to turn on the audio and rotate the knob to control the volume. Press the knob again to mute the audio. The volume will stay muted even after an ignition cycle. Press and hold the knob to turn the Center Information Display (CID) on or off. When the CID is off, you can still touch the bottom of the screen to adjust the climate control. The CID will turn off again after you change the climate settings.
- 2 Tune:** Rotate the knob to change the channels.
- 3 Car Settings:** Press to display the Car Settings menu.
- 4 Auto Start-Stop:** Press to activate or deactivate Auto Start-Stop.
- 5 Home:** Press to return to the Home screen.
- 6 Driver Profile:** Press to display, set up, or edit driver profiles.



Controlling the Volume

Adjusting the Volume: Turn the “VOLUME” knob to adjust the volume. The volume stays at your set level even after an ignition cycle.







Muting the Volume: Press and release the knob once to turn on or mute the audio.

Turning the System Off: Press and hold the knob for about three seconds and select “OK” when the message appears to turn the system off. The system remains off after an ignition cycle. Press and hold the knob to turn it back on.

STARLINK OVERVIEW

TOUCHSCREEN

Operations are performed by touching the screen directly with your finger.

MOTION	ACTION	USE
	Touch Quickly touch and release once.	Changing and selecting various settings
	Double Touch with one finger* Quickly touch and release twice with one finger.	Enlarging the scale of the map screen
	Double Touch with two fingers* Quickly touch and release twice with two fingers.	Reducing the scale of the map screen
	Drag** Touch and drag your finger on the screen to move the screen to the desired position.	<ul style="list-style-type: none">• Scrolling the lists• Scrolling the map screen*
	Swipe** Quickly move the screen by swiping with your finger.	<ul style="list-style-type: none">• Scrolling the lists• Scrolling the map screen*
	Pinch* Move your two fingers further apart (pinch-out) to zoom in on the map. Move your two fingers closer together (pinch-in) to zoom out on the map.	Changing the scale of the map screen

* 11.6-inch with Navi system only

** The operations may not be performed on all screens.

STEERING WHEEL CONTROLS

- 1 Presets/Skip:** Press to toggle through your presets or change a track or media file. Press and hold to fast-forward or rewind.
- 2 Volume:** Press the volume switch up or down to increase or decrease the volume.
- 3 Source:** Press the source button to change the audio sources between radio modes and media modes.
- 4 Voice Recognition:** Press to initiate the built-in voice recognition system. If you have an Android or Apple device paired, press and hold to start the Apple CarPlay®/Android Auto™ voice recognition function.
- 5 Call/End:** Press to receive or end a call without taking your hands off of the steering wheel.



Starlink Audio Controls

STARLINK OVERVIEW

VOICE RECOGNITION

With SUBARU STARLINK[®], simple voice commands can control features like navigation, entertainment, phone calls, and, on select models, climate control. A microphone is located in the overhead console. You do not need to speak directly into it.

 Visit www.subaru.com/owners/starlink/multimedia.html for more information.

Press the voice recognition switch to start the voice recognition system. Press and hold the switch to cancel it.

For help with what you can say with voice recognition, press the “Help” button on the screen or press the voice recognition button and say “Help”.

Tips

The system may not recognize the voice command due to various types of interference. Some causes for voice command interference are:

- The command is spoken too quickly or at a low or high volume.
- The command is incorrect or unclear.
- The window is open, the climate control system is set on high, or the ventilation is directed toward the microphone.
- Passengers are talking while the command is spoken.

In some cases, you may not be able to use voice commands if the system cannot properly recognize the command. For example, the command is incorrect or unclear.

NOTE: The system is designed to recognize a variety of commands, but certain words, accents or speech patterns may be difficult for the system to recognize.

Google Assistant: May not work with all devices or may not be compatible with the audio system.

Siri Eyes Free: Press and hold the Voice Recognition Button when your phone is connected via bluetooth for Siri Eyes Free.



Scan to learn more
about
Subaru Multimedia.

STARLINK OVERVIEW

Common Commands

Below is a list of some of the common commands that you can use with the voice recognition system. Please refer to your SUBARU STARLINK® Owner's Manual for a complete list.

VOICE COMMAND	FUNCTION	EXAMPLE
Dial [Number]	Places a call to the phone number	Dial 555-123-4567
Call [Name] [Phone Type]	Places a call to the contact name and phone type of the contact from the phonebook	Call John Doe mobile
Navigate to [House Number, Street, City, State] ¹	Sets a destination to the address	Navigate to 1234 Main Street, Lincoln, Washington
Show Map ¹	Displays the map screen	Show Map
Where am I ¹	Displays current location on map	Where am I
Tune to [Frequency] (AM / FM)	Switches to AM/FM and tunes to spoken frequency	Tune to 99.5 FM
Preset [Number]	Switches to the preset channel	Preset 3
Satellite Channel [Name / Channel Number]	Switches to satellite channel number	Satellite Channel Prime Country 55
Set Fan Speed to [1-7] ²	Sets the fan speed to the spoken fan speed	Set fan speed to 4
Set Temperature to [Number] ^{2, 3}	Sets the temperature to the spoken temperature	Set temperature to 70
Help	Changes to help screen	Help
Phone Help	Displays a list of voice commands related to controlling your phone	Phone Help
Media Help	Displays a list of commands related to the media	Media Help
Radio Help	Displays a list of commands related to the radio	Radio Help
Navigation Help ¹	Displays a list of voice commands related to navigation	Navigation Help

¹ 11.6-inch Multimedia Navigation system only

² 11.6-inch Multimedia Plus and 11.6-inch Multimedia Navigation system only

³ When the A/C is off, the A/C setting will not change even if the voice command is accepted

STARLINK HOME

HOME SCREEN ICONS

MySubaru – Whether you're on the road or planning adventures, the MySubaru app makes loving every part of owning your Subaru easy.

Apps - Entertainment and convenience applications to enhance your driving experience. The apps included are: MySubaru, Travel Link®, Android Auto™, SUBARU STARLINK® and Apple CarPlay®.

Radio – Select a station to listen to as well as pause and playback live radio.

Car Info – Displays the operating status of vehicle functions, vehicle status, and vehicle inclination in the “Driving Statistics” screen. The current setting of various vehicle functions and a brief description of each function can be viewed in the “Advanced Package” screen and vehicle maintenance intervals in the “Maintenance” screen.

SUBARU STARLINK® – Wireless pairing and hands-free smartphone operation allow for safe and easy connection to your favorite apps and content. You can access news, navigation, music, podcasts, and more through the available SUBARU STARLINK® app.

Map – Enter a destination and have route guidance to get you where you are going.

Media – Play CDs, USB/iPod music or Bluetooth® audio by connecting to the device.

Phone – Place and receive calls and text messages.

Settings – Change the settings to your personal choice for select systems inside the vehicle.

Add Shortcut – Add icons for various functions to the home screen.

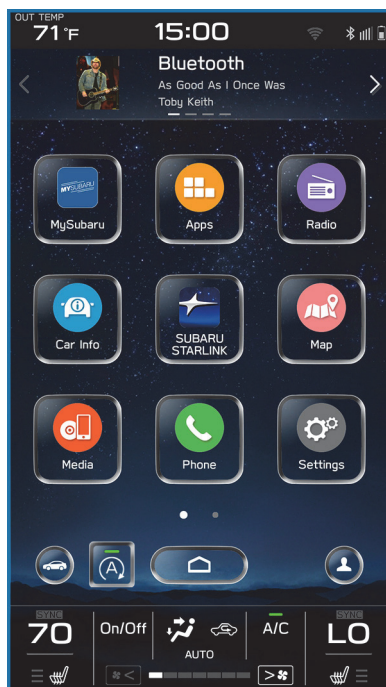

Scan to learn more
about
SUBARU STARLINK®.

REARRANGING ICONS

You can rearrange the home screen icons when in Edit Mode (first make sure "Home Screen Shortcuts" is enabled in "Settings").

To rearrange icons:

- 1 Select and hold the shortcut icon you want to move until "Edit Mode" is displayed at the top of the screen.
- 2 Drag the icon to the desired position and release.
- 3 To delete an icon, drag the icon to the bottom of the screen labeled "DRAG HERE TO DELETE" and release.
- 4 To exit "Edit Mode" touch the "Home" button.

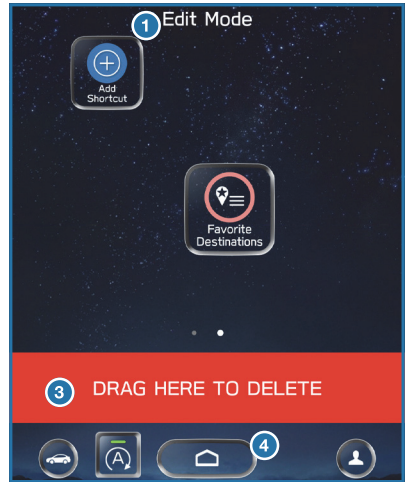

STARLINK HOME

ADDING SHORTCUTS

You can add shortcut icons for various functions to the Home screen when the Home Screen Shortcut function is turned on. To turn on the Home Screen Shortcut function, go to “Settings”, then the “General” menu.

To add icons, press the “Home” button.

- 1 Select “Add Shortcut”.

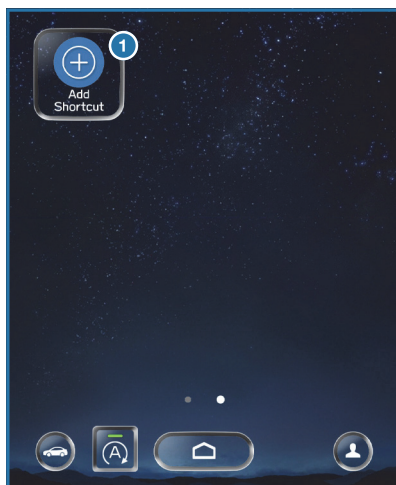

- 2 Select the desired function.

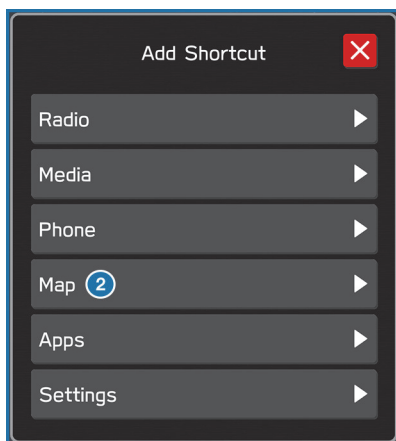

STARLINK HOME

- 3 Select the desired shortcut function.

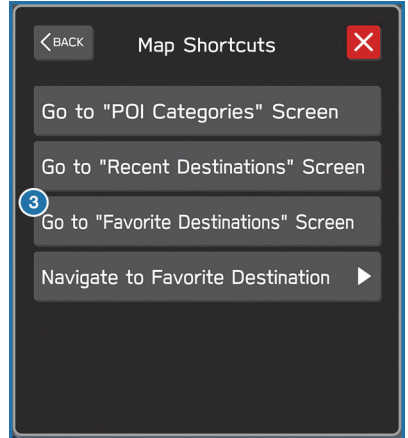

- 4 Check that the shortcut icon is displayed on the Home screen.



CREATING A DRIVER PROFILE

CREATING A DRIVER PROFILE

Creating a Driver Profile provides many benefits beyond just pairing a phone. The profile records and remembers station presets, sound preferences, phone favorites, screen icons and placement.

HOW TO CREATE A PROFILE

To create a driver profile:

- 1 On the Home screen, select the Driver Profile button.
- 2 Select "Add".

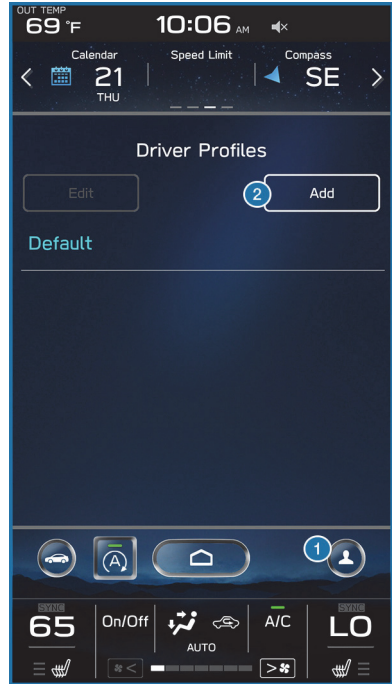

CREATING A DRIVER PROFILE

- 3 Select a language and then select "Next".

The screenshot shows a dark-themed interface titled "System Language" with a red close button in the top right. At the top, there are three numbered steps: "1 Language", "2 Name", and "3 Phone". Below this, the instruction "Select the language for your profile." is displayed. Three language options are listed: "English" (selected with a blue circle and a blue toggle switch), "Français", and "Español" (both with unselected toggle switches). At the bottom right, there is a "3 NEXT" button with a right-pointing arrow.

- 4 Select "Driver's Name".

The screenshot shows a dark-themed interface titled "Driver Name" with a red close button in the top right. At the top, there are three numbered steps: "1 Language", "2 Name", and "3 Phone". Below this, the instruction "Enter a name for the driver profile." is displayed. A text input field contains the text "Driver's Name" and has a blue circle with the number "4" next to it. A right-pointing arrow is visible at the end of the input field. At the bottom, there are two buttons: "BACK" with a left-pointing arrow and "NEXT" with a right-pointing arrow.

CREATING A DRIVER PROFILE

- 5 Type your name in using the keyboard screen, select “Next”, and select “Next” on the following screen to go to phone pairing.

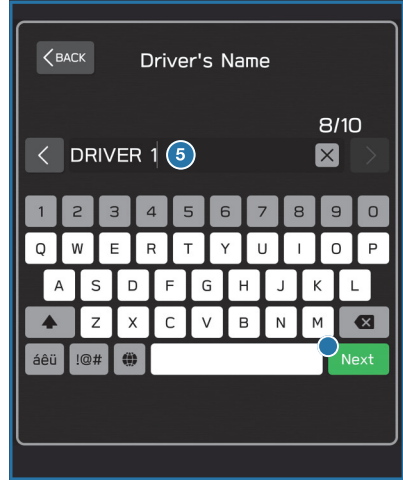

- 6 Select “Add Phone” to pair your phone to the system (see page 130 and 133 in the How To Appendix) or select your phone if it is already paired.
- 7 Select “Finish”.

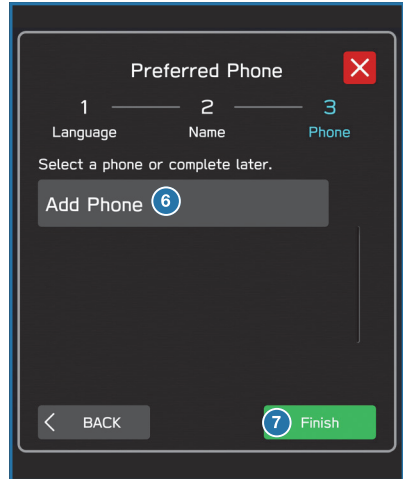

CREATING A DRIVER PROFILE

To edit a driver profile:

- 1 On the Home screen, select the Driver Profile button.
- 2 Select "Edit", then select a profile. You can then edit the profile according to same steps as creating a profile.



Retrieving a Driver Profile

There are two ways to retrieve a driver profile. The system may automatically retrieve the profile once you are in your Subaru with the multimedia system on and your phone's Bluetooth® active. You can also manually retrieve or change the profile by following these steps:

1. Press the "Driver Profile" button.
2. Select the profile you want. You will receive a pop up screen asking "Are you sure you want to activate this profile?"
3. Select "OK".

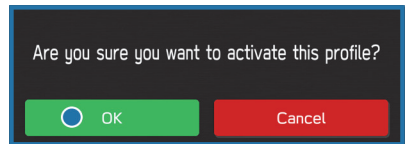

MULTIMEDIA

RADIO

AM/FM Radio

Your Subaru is equipped standard with AM/FM radio which includes HD Radio™. HD Radio™ technology is the digital evolution of analog AM/FM radio. Your radio has a special receiver which allows it to receive digital broadcasts (where available) in addition to the analog broadcasts it already receives. Digital broadcasts have better sound quality than analog broadcasts, as digital broadcasts provide free, crystal clear audio with no static or distortion.

 Visit www.hdradio.com for more information and a guide to available radio stations and programming.



Scan to learn more about HD Radio.

Satellite Radio

A SiriusXM® Satellite Radio is a tuner designed exclusively to receive broadcasts provided under a separate subscription. After a free trial period, a subscription is necessary to continue service.

 For more information or to subscribe, visit www.siriusxm.com.



Scan to learn more about SiriusXM Radio.

Setting Presets

You can preset 18 stations. Presets can be set for SiriusXM®, FM, or AM stations, allowing you to switch among the three with the press of a single button. To preset a radio station:

1. Tune to the desired channel.
2. Press and hold one of the desired preset station buttons.



MULTIMEDIA

MEDIA

Bluetooth®

Your Subaru has Bluetooth® hands-free technology to manage your phone and audio systems. Bluetooth-enabled mobile phones link directly through your Touchscreen automatically, once connected. Receive and initiate calls or play music directly from your device while keeping it stowed for safety.

To pair a Bluetooth® device to the Touchscreen, see page 130 for Android devices or page 133 for Apple devices.

CD (if equipped)

The CD player holds a single disc. To access the CD menu, put a CD in the player or on the Home Screen, select "Media", then select "CD". Depending on the CD format, the Touchscreen may show the CD album artwork.

USB / iPod

The USB connection is below the Center Information Display (CID) in front of the select lever. You can plug in a USB memory storage device or iPod. This will bring up the media screen with controls. If using an iPod, make sure to use an Apple certified cable or MFi certified cable for proper operation.

Aux Input

The Aux jack is a port that allows the input from an audio device such as MP3 players, portable music players and iPods. To access the Aux menu, plug in the device to the Aux jack and the menu will appear, or select the Aux menu from the Touchscreen under "Media".

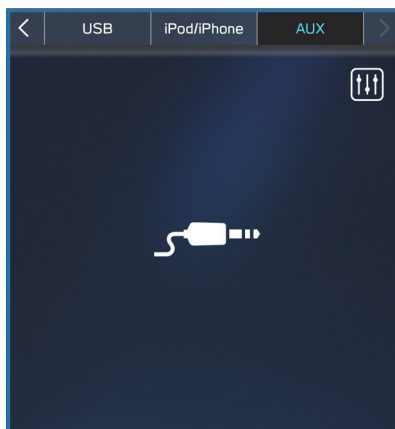

PAIRING A PHONE

Using a Bluetooth® connection with the Touchscreen allows you to use the voice recognition system to make and receive calls. It provides access to your phone book on your phone and can read incoming text messages as well as reply via voice recognition. It remembers your driver profile when your phone pairs via Bluetooth®.

For instructions on how to pair your phone to the Touchscreen, see page 130 for Android devices or page 133 for Apple devices.

Visit www.subaru.com/owners/starlink/multimedia.html for complete details on what is available by connecting a phone to the Touchscreen.



Scan to learn more
about
Subaru Multimedia.

PHONE

MAKING A CALL

You can make a call through voice recognition by touching the “Voice Recognition Switch” on the steering wheel to start the voice recognition system. After pressing the “Voice Recognition Switch”, wait for the “Voice Guidance” screen to appear on the Touchscreen and say “Call [name and phone type]” or “Dial [number]”.

To make a call from the Touchscreen, start by pushing the “Home” button and then select “Phone”. After the phone screen displays, select the method you would like to use to make a call.

- Recent – Allows you to call someone that has recently called you or that you called.
- Favorites – Allows you to place a call to one of your favorites on your phone.
- Phonebook – Will display the phonebook that is on your phone.
- Messages – Allows you to call someone that recently sent you a text message.
- Keypad – Allow you to dial any number you would like.

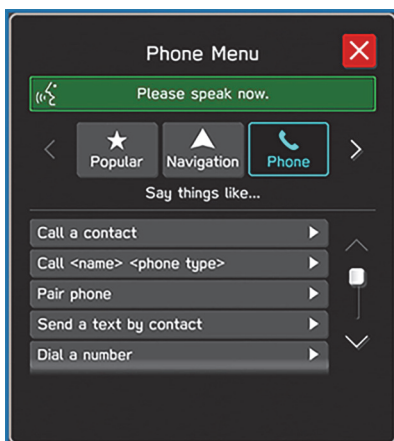

RECEIVING A CALL

To receive a call, press the “Talk” switch on the steering wheel or the “Accept” button on the Touchscreen.



To reject a call, press the “End” switch on the steering wheel or the “Decline” button on the Touchscreen.

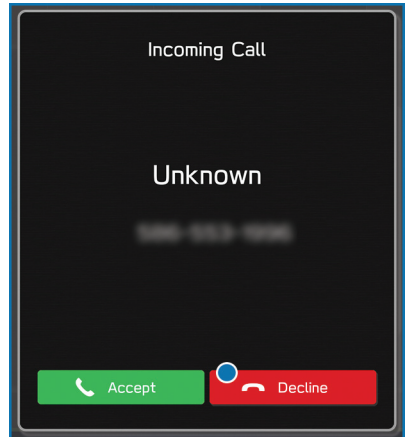

PHONE

TEXT MESSAGES

Received messages can be forwarded from the connected Bluetooth® phone, enabling checking and replying using the system. To use this function, it is necessary to set the phonebook download function to ON.

When a Short Message Service (SMS)/ Multimedia Messaging Service (MMS) is received, the incoming message screen pops up with sound and is ready to be retrieved using the Touchscreen. Select “Play” to listen to the message. You can also select the “Reply” button to reply to the sender using a generated message.

If there is more than one unread message, this screen will appear to allow you to either view your inbox or ignore the message.

Depending on the Bluetooth® phone type, the screen display may differ, messages may not be transferred to the message inbox, or it may not be possible to use certain functions.

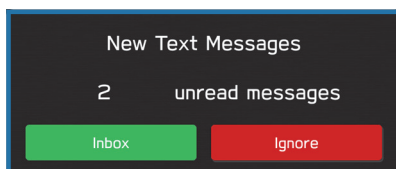
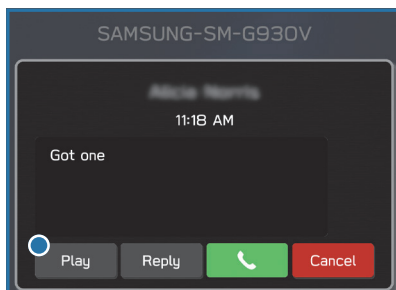

SUBARU STARLINK® IN-VEHICLE APPS

SUBARU STARLINK® Multimedia offers advanced connectivity through Apple CarPlay® or Android™ Auto apps. Wireless pairing and hands-free smartphone operation allow for safe and easy connection to your favorite apps and content. You can access news, navigation, music, podcasts, and more through the available SUBARU STARLINK® app.

For a complete list of all the apps available, visit www.subaru.com/owners/starlink/multimedia.html.



Scan to learn more about
Subaru Multimedia.

Android™ Auto

Android Auto™ can be used to view maps, play music, and place calls by connecting your Android device to the system. Supported applications can also be run.

 For more information, please refer to page 136.

For details on the services or the operations, visit the Android Auto sites www.android.com/auto/ or www.support.google.com/androidauto/



Scan to learn more about
Android Auto



Scan to learn more about
Android Auto Help

To use the Android Auto™ application, connect your Android device to the USB port.

Apple CarPlay®

Apple CarPlay® can be used to view maps, play music, and place calls by connecting your iPhone to the system. Supported applications can also be run.

 For more information, please refer to page 137.

For details on the services or the operations, check the Apple CarPlay® site: www.apple.com/ios/carplay/

To use the Apple CarPlay® application, connect your iPhone to the USB port.



Scan to learn more about
Apple CarPlay

APPS

SiriusXM® Travel Link

SiriusXM® U.S. satellite and data services are available in the 48 states of the contiguous USA and DC.

Data service information, comprising sports, weather, stock and fuel, can be received via the SiriusXM® Radio.

To receive the data service information in the vehicle, a subscription to the SiriusXM® Satellite Radio Service is necessary following a free trial.

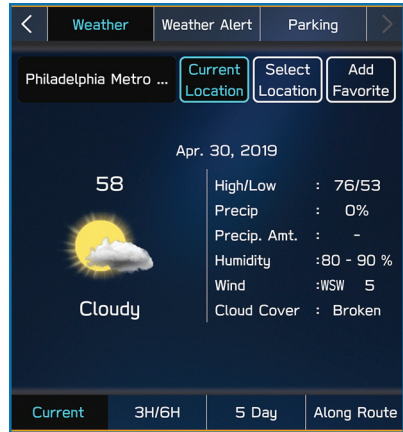

SUBARU STARLINK® MOBILE APP

There are several key applications that can be loaded to your phone and used while in your Subaru to help you while you drive. You must also download and log in to the SUBARU STARLINK® app on your phone to use these apps.

To download the SUBARU STARLINK® app, go to the Apple App Store or the Google Play Store and search for SUBARU STARLINK® in the menu.

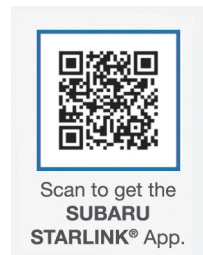
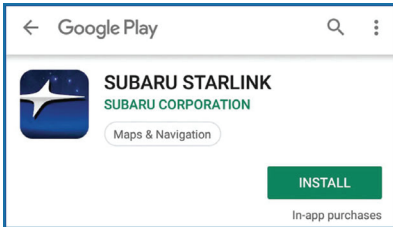

Below are a few apps that you may find helpful.

Quick Reference Guide

This is the digital version of the original printed Getting Started Guide that is standard in all new Subaru vehicles. The app features In-Vehicle Help (IVH) that provides an interactive, searchable, model-specific concierge through the Touchscreen.

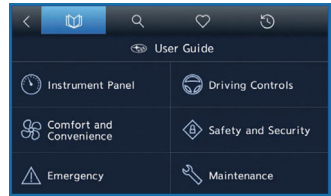
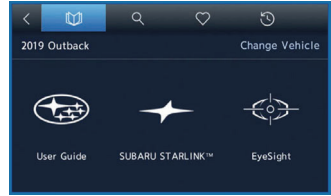

Chimani

Get the most comprehensive guide to all 417 national parks in the United States. Quickly learn about each park's history and highlights.

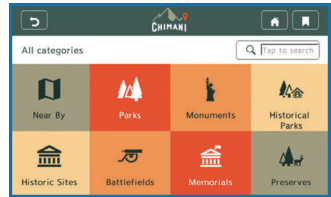

eBird

Exclusive to Subaru vehicles, the eBird app tells you what birds are being seen near you in real time. Based on a database of millions of bird sightings, eBird acts as a "digital coach" for finding birds. Use the app to decide where to go based on the distance to a great birding location and the species being seen there. For example, the app may tell you the nearest sighting of a certain species is 8 miles away and navigate you to the last place it was seen. Full-screen photos help you confirm your sightings.

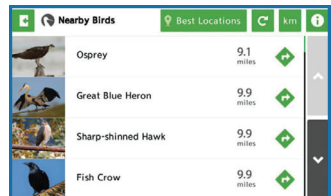
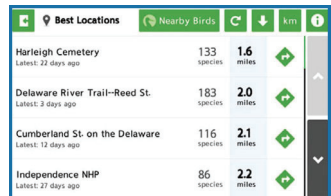

APPS

MYSUBARU

Whether you're on the road or planning adventures, the MySubaru app makes loving every part of owning your Subaru easy. Although the mobile app is great when you are on the go, you can also visit www.MySubaru.com from your computer to access the same functions and to aid in planning your trip before you leave.

You can download the MySubaru app from the Google Play Store or the Apple App Store on your phone by searching MySubaru.

By creating an account, you can:

- Schedule service with a Preferred Subaru Retailer
- Get vehicle service reminders, recall alerts, and exclusive coupons
- Track and record your service history
- Access resources like your owner's manuals, how to videos and more
- Have access to SUBARU STARLINK® Safety and Security features (must have an active SUBARU STARLINK® subscription)
- Get help from 24-hour roadside assistance (24-hour roadside is included in standard 3-year warranty, and after 3 years with a Concierge package)



Scan to get the
MySubaru App.

Service Appointment Scheduler

The SUBARU STARLINK® Service Appointment Scheduler can help you set an appointment from the MySubaru website, Mobile App or the vehicle's Touchscreen. Getting your Subaru vehicle to the Subaru professionals for service is easy, no matter where you are. If you are away from your preferred Subaru Retailer for service, you can always use Service Appointment Scheduler to locate any of our certified Subaru Retailers near your location.

SUBARU STARLINK® Service Appointment Scheduler on your Touchscreen is a convenient way to set a service appointment. Simply select the MySubaru icon on the Home screen and choose "Make an Appointment" to get started.

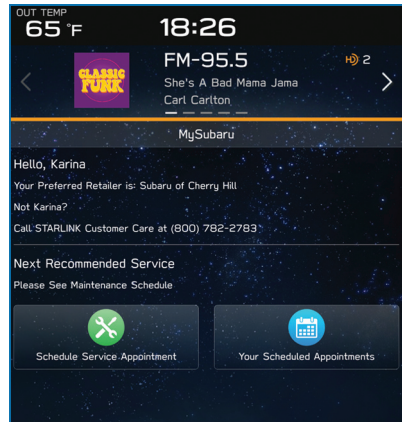

MAPS OVERVIEW

Your new SUBARU STARLINK® comes equipped with an integrated navigation system, powered by TomTom. We hope you enjoy the state-of-the-art navigation technology and optimized mapping routes to guide you on safer, better, and more enjoyable journeys.

With your integrated navigation system, you can find destinations by address or search by points of interest, as well as save destinations in the system as favorites. You can also customize route options and settings and find the nearest gas station along your route with the touch of a button.

 For more information and step by step directions on using your navigation system, please refer to page 142 or the STARLINK® Owner's Manual.





Scan to learn more
about the features
of your
navigation system.

STARLINK SAFETY AND SECURITY

SAFETY AND SECURITY OVERVIEW

STARLINK® Safety and Security services* are designed to help in your time of need. These include Advanced Automatic Collision Notification, SOS Emergency Assistance, Enhanced Roadside Assistance, Stolen Vehicle Recovery, the added convenience of Remote Engine Start with Climate Control, and so much more.



With the SUBARU STARLINK® system integrated into your vehicle, advanced safety and security technology is just a button press away. The SUBARU STARLINK® experience includes in-vehicle call center support, maintenance and diagnostic alerts as well as remote services that keep you connected to your Subaru vehicle.

Located in the overhead console of most Subaru vehicles are the red SOS  and blue i-button . Both buttons link you to the SUBARU STARLINK® call centers that are there to support you 24 hours a day, 7 days a week.

The SOS button  is for SOS Emergency Assistance.

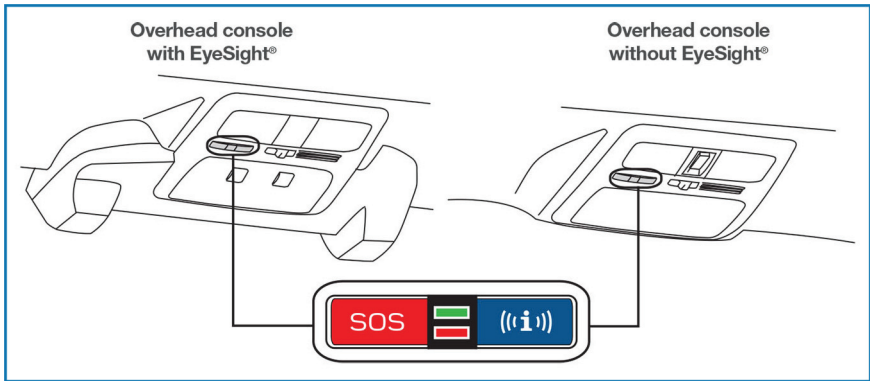
The i-button  is for Enhanced Roadside Assistance or Concierge (if subscribed).



- Press the SOS button  for SOS Emergency Assistance.*
- Press the i-button  for Enhanced Roadside Assistance* or Concierge* (if subscribed).*

STARLINK SAFETY AND SECURITY

- To cancel a SOS Emergency Assistance, Enhanced Roadside Assistance or a Concierge call, press and hold the same button for approximately two seconds or select the “End Call” button if displayed on the Touchscreen.

Head to www.Subaru.com/STARLINK to see all the SUBARU STARLINK® subscription services and packages.

* Access to STARLINK® Safety and Security services requires an active STARLINK® subscription. Remote Engine Start available on keyless access with push-button start vehicles. Remote Engine Start with Climate Control available on vehicles with keyless access with push-button start and automatic climate control. Not available on vehicles with manual transmission.



Scan to learn more
about **SUBARU**
STARLINK.

ENROLLMENT

To enroll in SUBARU STARLINK® and access remote services, a MySubaru account is required. MySubaru is the Subaru owner website that allows you to access vehicle remote services, user preferences, diagnostic alerts and other useful features enabled by your STARLINK® Safety Plus, STARLINK® Security Plus and STARLINK® Concierge subscription.

Your retailer may have created an account for you during the delivery process. However, you can also create a MySubaru account on www.mysubaru.com.

Enrollment in SUBARU STARLINK® can be done online at MySubaru.com, through the MySubaru Mobile App, at your Subaru retailer or by calling a STARLINK® Customer Care Representative at:1-855-753-2495

NOTE: Please have your Vehicle Identification Number (VIN) available, as you will need it to complete this step. After the enrollment process, you will learn more about the features in detail at MySubaru.com.

STARLINK SAFETY AND SECURITY

MYSUBARU INTEGRATION

The connection between you and your Subaru has never been simpler, and the MySubaru website (MySubaru.com) and MySubaru Mobile Application are the best ways to stay in touch with your Subaru vehicle. From MySubaru, you can access the following information and STARLINK® Safety and Security services*:

- Remote Services
- Vehicle Health
- Usage Reports
- Service Appointment Scheduler
- Vehicle Maintenance Schedules
- Destination to Vehicle
- Service History
- Support Resources

* Internet access is purchased separately through AT&T with monthly, per gigabyte, and unlimited data options available. Existing AT&T customers have the option to add an additional line to their AT&T Mobile Share plan. Available on select models.

SUBARU STARLINK® WI-FI HOTSPOT

SUBARU STARLINK® in-vehicle Wi-Fi Hotspot keeps you and your family connected using AT&T's 4G LTE nationwide cellular network. Whether watching movies, playing games or even listening to music, your family won't miss a beat with SUBARU STARLINK® in-vehicle Wi-Fi Hotspot. Set up is quick and easy.

 For more information on a subscription and step by step enrollment instructions, please refer to page 140 or visit: <https://www.att.com/plans/connected-car/subaru.html>



Scan to learn
more about **AT&T**
Wi-Fi Hotspot

SETTINGS AND UPDATES OVERVIEW

Many settings can be customized for different features in your Subaru. In this section you will find examples and instructions for some of the settings you can tailor to fit your preferences, as well as ways to keep your system updated.

Connect to Home Wi-Fi

Connecting to your Wi-Fi network can allow you to update the software and maps. Wi-Fi can be found from the Home Screen by selecting “Settings”. To access Wi-Fi settings and available networks:

1 In the “General” menu, select “Wi-Fi”.

For step by step instructions on connecting to Wi-Fi, please refer to page 139 or your STARLINK® Owner’s Manual.



Performing Software Updates

Software updates provide enhancements to the system, such as new features, added security, and upgraded functions. You can ask your preferred Subaru retailer to check for and perform a full update to the system software. Please ask your preferred Subaru retailer for specific details on update content.

For the 11.6-inch Multimedia Plus and the 11.6-inch Multimedia Navigation systems, some system software can be updated via a Wi-Fi network. The update process involves downloading and installing the software update.

NOTE: System functionality will be restricted during installation, and you may need to reset radio station presets and volume settings after the update process.

For step-by-step instructions and more information, please refer to page 161 or your STARLINK® Owner’s Manual.

SETTINGS AND UPDATES

SOUND

To change the sound settings, press the “Home” button and select “Settings”, then “Sound”. Choose the setting you want to change.

SETTING	FUNCTION
Audio	<p>In the audio settings, you may have the following setting capabilities:</p> <ul style="list-style-type: none">• Sound Customization — This function allows you to set the Equalizer, Balance/Fader and Vocal Image Control.<ul style="list-style-type: none">• Equalizer — How good an audio program sounds is largely determined by the mix of the treble, mid and bass levels. In fact, different kinds of music and vocal programs usually sound better with different mixes of treble, mid and bass.• Balance/Fader — A good balance of the left and right stereo channels and of the front and rear sound levels is also important. Keep in mind that when listening to a stereo recording or broadcast, changing the right/left balance will increase the volume of 1 group of sounds while decreasing the volume of another.• Vocal Image Control — Extracts only vocal sound from whole sound and adjusts volume balance off vocals only.• Sound Restorer — This function plays compressed audio with quality near original sound by adding the complement signal of high tone.• Virtual Bass — This function corrects the bass sound by adding harmonic sound.• Dynamic Beat Enhancer — This function expands the dynamic range lost in data compression and creates a sharp beat sound.• Speed Volume Control — The system adjusts to the optimum volume and tone quality according to vehicle speed to compensate for increased vehicle noise.• AUX Volume Gain — Sets the AUX volume gain.
Navigation Guidance Volume	Sets the navigation prompt volume.
Notification Volume	Sets the interrupt guidance volume.
Beep Sound Setting	Turns the tone sound on or off.
Beep Sound Volume	Sets the tone sound volume.
Phone Ringtone Volume	Sets the ringtone volume.

SETTINGS AND UPDATES

SETTING	FUNCTION
Incoming Call Volume	Sets the volume of the received call.
Call Volume	Sets the call volume.
SMS/MMS Ringtone Volume	Sets the SMS/MMS ringtone volume.
SMS/MMS Read Out Volume	Sets the SMS/MMS read out volume.
Voice Volume	Sets the voice recognition prompts volume.

PHONE

This system supports Bluetooth[®], a wireless data system, allowing you to make and receive calls without taking your hands off the steering wheel.

In the settings menu, you will be able to manage devices, adjust phone book and message settings, and adjust other phone/Bluetooth[®] settings.

To access the phone settings screen, press the “Home” button, select “Settings”, then select the “Phone” menu.

SETTINGS AND UPDATES

MAPS/NAVIGATION

There are many settings that can be customized to your preference. These settings are under the “Setting” menu and then “Navigation”. Below are some of the common settings you may want to customize:

SETTING	FUNCTION
Show Along Route	Turn the display for parking lots, gas stations and rest areas on or off for the route being traveled during route guidance.
Arrival Distance/Time	Sets the display for the estimated remaining distance and estimated remaining time to the destination.
Freeway Exit Preview	Sets the freeway exit preview to on or off.
Automatic Zoom	Sets whether to automatically enlarge the map when approaching intersections or turning points during route guidance on or off.
Auto-Hide Route Bar	Sets the route bar auto-hide function to on or off.
Route Preference	Sets the preferred route type when searching for a new route.
Avoid	Sets avoidance criteria for the route calculation.
Traffic Warning Tone	Sets the traffic alert sound to on or off.
Map Update	Sets the updating of the map data.

Checking for Map Updates

You can update the maps to the latest information. The maps should be checked and updated regularly for the best possible navigation experience.

At www.subaru-maps.com, you can update the entire USA map at once via USB. The maps can also be updated over the air. When updating over the air, you can update eight regions at a time. This allows you to update your home state without having to download the entire map program for the United States. This option is great if you normally stay in your home state and/or surrounding states.

Updating Over-the-Air

To check for available updates over-the-air, first connect to a Wi-Fi network (see page 139). Map updates can be found by selecting “Settings”, then “Navigation” on the Touchscreen.

 For step by step directions for updating your maps through Wi-Fi, please refer to page 160.

SETTINGS AND UPDATES

Updating Maps Using Your PC/MAC

Maps can also be updated using a USB memory device, which will allow the entire map program to be updated at one time. This is a great option if you are going to take a cross-country trip and your maps have not been updated in a while.

To update the map using a USB memory device, start by going to www.subaru-maps.com.



Scan to learn more about
Map Updates

CLOCK

Clock settings can be adjusted when the ignition is in the “ON” position. You can adjust the clock manually or set the clock to adjust automatically on the clock setting screen. To access the clock setting screen with a single step:

- 1 Select the clock on the status bar at the top of the Center Information Display.
- For more information on clock settings and full step-by-step instructions on adjusting the clock both manually and automatically, please refer to page 123.

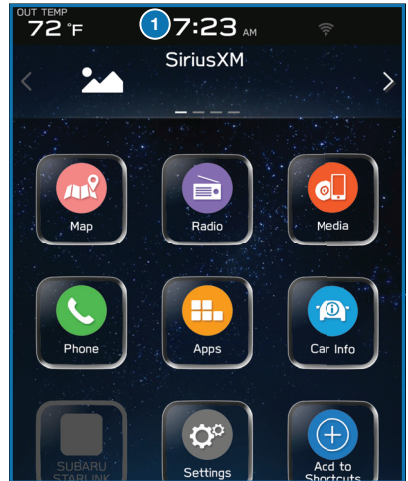

EYESIGHT

EYESIGHT® OVERVIEW

Your Subaru features a variety of safety systems that are the culmination of everything Subaru Engineers know about safety. These systems are referred to as “Driver Assist Technologies” and add confidence to every trip you and your passengers take. Working together, these systems provide enhanced awareness, safety, and convenience in front, to the sides, and behind your Subaru. Subaru Driver Assist Technologies include:

- EyeSight® Driver Assist Technology
- Rear-Vision Camera
- Pre-Collision Braking
- Front View Monitor
- Blind-Spot Detection (BSD)
- Rear Cross-Traffic Alert (RCTA)
- Reverse Automatic Braking (RAB)
- High Beam Assist (HBA)
- Lane Departure Prevention
- Steering Responsive Headlights (SRH)

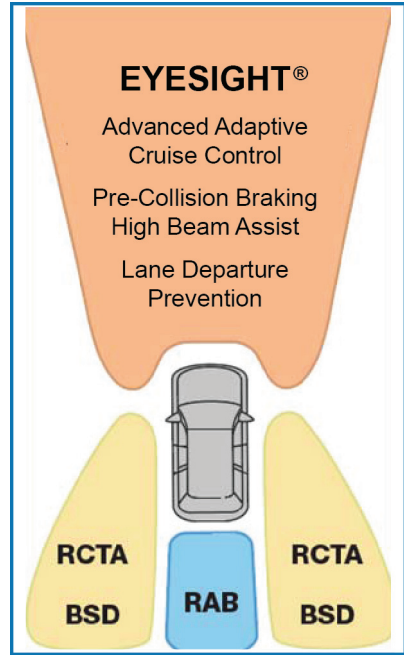

OPERATION

EyeSight® is a driver assist technology that uses dual color cameras to serve as an extra pair of eyes on the road ahead to identify vehicles in front, pedestrians, traffic lanes, or other objects. If need be, the EyeSight® system can apply the brakes and/or reduce engine power to help avoid or reduce the severity of a collision. During these events, the system will provide audible and visual alerts to assist you in making decisions.

Since the characteristics and limitations of the EyeSight® color cameras are similar to human eyes, it is important that the cameras, windshield, and area in front of the cameras are treated with special care. Please refer to “Care and Limitations” on page 120 for more details.



EyeSight Cameras (inside)



EyeSight Cameras (outside)

FUNCTIONS

The EyeSight® system features several distinct functions designed to provide extra awareness, improve safety, reduce fatigue, and add peace of mind every time you drive your Subaru. EyeSight® functions include:

- Pre-Collision Braking (PCB)
- Pre-Collision Brake Assist
- Pre-Collision Throttle Management
- Lane Departure Warning (LDW)
- Lane Sway Warning
- Lane Departure Prevention
- Advanced Adaptive Cruise Control
 - Advanced Adaptive Cruise Control (AACC)
 - Lane Centering
- Conventional Cruise Control
- Lead Vehicle Start Alert

EYESIGHT

Pre-Collision Braking

This function helps prevent or minimize a frontal collision with another vehicle, pedestrian, or other objects by providing visual and audible warnings. Warnings are displayed in the Combination Meter Display (CMD) with audible beeps. If you take no corrective action, the system automatically reduces engine power and applies the brakes with increasing force to help prevent or minimize the collision.

This system can be turned on or off in the Center Information Display (CID) (see page 110).



Pre-Collision Brake Assist

This function recognizes a possible collision with another vehicle, a pedestrian, or object in front while you are applying the brakes. If the system determines not enough force is applied, it can assist by applying additional pressure to the braking system to decrease stopping distance.

This system can be turned on or off in the Center information Display (CID) (see page 110).

Pre-Collision Throttle Management

This function is designed to help prevent you from unintentionally accelerating into a stopped vehicle or other obstacle by reducing engine power. Warnings are displayed in the Combination Meter Display (CMD) with audible beeps.

Pre-Collision Throttle Management is helpful when:

- You unintentionally place the select lever in the “D” position instead of the “R” position and start to accelerate toward a parked car, wall or parking structure.
- While you are at a stop, the vehicle ahead of you accelerates, but then suddenly slows down or stops as you begin to accelerate.

This system can be turned on or off in the Center Information Display (CID) (see page 110).

Lane Departure Warning

This function provides audible and visual warnings if you are about to depart your lane of travel. Using the EyeSight® camera, the Lane Departure Warning function identifies lane markings when traveling at speeds of approximately 30 mph or greater. These warnings are displayed in the Combination Meter Display (CMD) with audible beeps. Lane Departure Warning does not provide any corrective actions.

You can turn this system on or off in the Center Information Display (CID) (see page 110).

Lane Sway Warning

This function detects repetitive or unusual side-to-side vehicle movement within a lane of travel that may indicate a drowsy or inattentive driver. Using the EyeSight® camera, the Lane Sway Warning function identifies lane markings when traveling at speeds of approximately 37 mph or greater. Warnings are displayed in the Combination Meter Display (CMD) with audible beeps. Lane Sway Warning does not provide any corrective actions.

You can turn this system on or off In the Center Information Display (CID) (see page 110).



EYESIGHT

Lane Departure Prevention

This function provides steering assistance to keep your Subaru in its lane of travel when cruising on expressways, freeways, and interstate highways. Using the EyeSight® camera, the Lane Departure Prevention Function identifies lane markings when traveling at speeds of approximately 37 mph or greater.

Operate the Center Information Display (CID) to turn on/off the Lane Departure Prevention Function by selecting “All Functions” or “Lane Departure Prevention Function Only” on the “Lane Departure Prevention Function” screen of the EyeSight® settings.



As you drive the vehicle above the minimum speed, white lane marking graphics on the CMD will indicate that right and/or left lane markings have been successfully identified by the EyeSight® camera.

If your Subaru is about to depart the driving lane, the system can assist the steering by gently guiding the vehicle back into your lane. When the system is actively providing assistance, the lane indicator on the side where the Lane Departure Prevention Function activated changes from white to yellow.

Advanced Adaptive Cruise Control with Lane Centering

Advanced Adaptive Cruise Control is a driving support system intended to reduce the burden on you when driving on an expressway (including during congestion and when driving at high speed). Advanced Adaptive Cruise Control and Lane Centering work together to assist you by automatically controlling the accelerator, brake, and steering.

Advanced Adaptive Cruise Control

This system provides cruise control with the ability to keep a safe distance from the car in front of you. Using the EyeSight® camera, the Advanced Adaptive Cruise Control function identifies vehicles in front of you in the same lane, and your vehicle follows the vehicle in front (up to the maximum of your set speed). While following, your vehicle will automatically maintain a following distance that corresponds to the speed of the vehicle in front. The vehicle is capable of being controlled at a speed between 0 mph and approximately 90 mph.



You can turn the Advanced Adaptive Cruise Control on or off using the Adaptive Cruise Control On/Off button on the right side of the steering wheel (see page 107). Once the system is turned on, a white Adaptive Cruise Control icon will be displayed on the Combination Meter Display (CMD). When all the operational conditions are met, “READY” appears underneath the Adaptive Cruise Control icon.

To set Advanced Adaptive Cruise Control, push down the “SET/–” switch on the right side of the steering wheel. The CMD will indicate a target speed and the icon will turn green. This speed can be adjusted up or down using the “RES/SET” switch (see page 107).

When a vehicle in front of you is identified, a Lead Vehicle icon will be displayed on the Combination Meter Display (CMD). You can change the desired following distance from the lead vehicle by pressing the “Increase Distance” or “Decrease Distance” buttons (see page 107).

EYESIGHT

Lane Centering

The stereo camera detects lane markings (including Botts' dots) of the lane and the lead vehicle, and the system assists the steering operation by working with the electric power steering to help keep your vehicle in its lane when driving on expressways, freeways and interstate highways.

This function can be used by pressing the Lane Centering switch when Advanced Adaptive Cruise Control is activated. When driving at speeds of 0 mph to approximately 90 mph, the system detects the lane markings or the lead vehicle and assists you with steering in order to keep the vehicle close to the center of the lane.



Conventional Cruise Control

Conventional Cruise Control maintains a constant traveling speed you set, but it does not adapt to the other vehicles in front of you. To activate Conventional Cruise Control, press the Adaptive Cruise Control On/Off button to set Advanced Adaptive Cruise Control into standby status. Then, with Advanced Adaptive Cruise Control in standby status, press and hold the "Increase Distance" or "Decrease Distance" button on the steering wheel for approximately two seconds.

The Cruise Control indicator on the Combination Meter Display (CMD) will change from the Adaptive Cruise Control icon to the Conventional Cruise Control icon. Use the accelerator to reach the desired speed, then use the RES +/SET - switch to set the vehicle speed.



Lead Vehicle Start Alert

This function will provide a visual and audible alert when a stopped vehicle in front of you begins to move, and your vehicle remains stationary. Warnings are displayed in the Combination Meter Display (CMD) with audible beeps. Lead Vehicle Start Alert is helpful in situations where you may become temporarily distracted at a traffic light, and the vehicle ahead begins to move.

Navigate the CID (select “Settings”, then the “Car” menu) to access the EyeSight® settings menu to turn this function on or off.



STEERING WHEEL CONTROLS

Advanced Adaptive Cruise Control

- 1 **Adaptive Cruise Control On/Off:** Press to turn Advanced Adaptive Cruise Control on or off.
- 2 **Lane Centering:** Press to turn on or off Lane Centering when Advanced Adaptive Cruise Control is active.
- 3 **Increase Distance:** Press to increase the following distance setting while using Advanced Adaptive Cruise Control. Press and hold to change to Conventional Cruise Control.
- 4 **Decrease Distance:** Press to decrease the following distance setting while using Advanced Adaptive Cruise Control. Press and hold to change to Conventional Cruise Control.
- 5 **Resume (RES)/Increase Speed and Set (SET)/Decrease Speed:** Press the switch down to set an initial target speed. Once set, press up or down to adjust the target speed.
 - **Adjust by 5 mph:**
 - Briefly press the switch up to increase the target speed by 5 mph.
 - Briefly press the switch down to decrease the target speed by 5 mph.



Advanced Adaptive Cruise Control Switches

EYESIGHT

- **Adjust by 1 mph:**

- Press and hold the switch up to increase the target speed in 1 mph increments.
- Press and hold the switch down to decrease the target speed in 1 mph increments.

- The Cruise Control Acceleration Characteristics can be adjusted to four different levels depending on your preference. The four levels are:

- Lv. 1 Eco
- Lv. 2 Comfort
- Lv. 3 Standard
- Lv. 4 Dynamic

Cruise Control Acceleration Characteristics can be adjusted in the Center Information Display (CID). To Access the settings, select the “Car Settings” icon, then in the “Vehicle Control” menu, select “Cruise Control Acceleration Characteristics”.

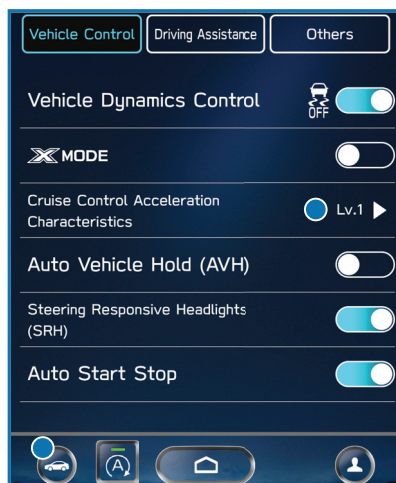

Customizing EyeSight® Settings

The EyeSight® system features customization of certain preferences and warnings. Select “Settings”, then “Car” or select the “Car Settings” icon to adjust a number of EyeSight® Settings in the Center Information Display, such as:

- Warning Volume: Min/Mid/Max
- Cruise Control Acceleration Characteristics: Eco/Comfort/ Standard/Dynamic

EYESIGHT® ASSIST MONITOR (EAM)

The EyeSight® Assist Monitor (EAM) provides a heads-up display of EyeSight® system functions in the lower windshield area allowing you to keep your eyes on the road ahead.

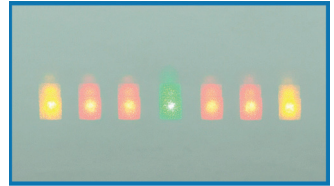

The EAM indicators can be changed by selecting “Settings”, then “Car” to access the “EyeSight® Assist Monitor” settings menu in the Center Information Display. Below are the indications provided by the EAM function:

LED COLOR	PATTERN	WARNING CONDITION
Green	Solid illumination	A lead vehicle is detected ahead while Advanced Adaptive Cruise Control is operating.
Yellow	Flashing on one side	The Lane Departure Warning is operating. The side where the vehicle has left its lane flashes, and the side that has not left its lane illuminates.
	Flashing alternately	Lane Sway Warning is operating.
	Flashing simultaneously	<ul style="list-style-type: none"> Steering wheel operation is not be detected for a certain period of time. Lane Centering or Lane Departure Prevention Function was canceled automatically by the system (flashing rapidly).
Red	Flashing simultaneously (4) indicators	<ul style="list-style-type: none"> Following Distance Warning, Pre-Collision Braking System, Obstacle Detected Warning, or Pre-Collision Throttle Management is operating. Lane Centering Function was canceled when there was no operation of the steering wheel.
	Flashing on one side	Lane Centering Function is active and the vehicle appears likely to depart the lane. The side where the vehicle has left its lane flashes, and the side that has not left its lane illuminates.

LANE DEPARTURE WARNING AND PRE-COLLISION BRAKING SYSTEM OFF

Lane Departure Warning OFF

Select the “Car Settings” icon, then in the “Driving Assistance” menu, select “Lane Departure Prevention Function” to choose your desired operation setting for Lane Departure Warning and Lane Sway Warning.

When these functions are off, a yellow Lane Departure Warning OFF indicator will be illuminated in the Combination Meter. It may be helpful to turn these functions off when lane markings on the road are inconsistent.

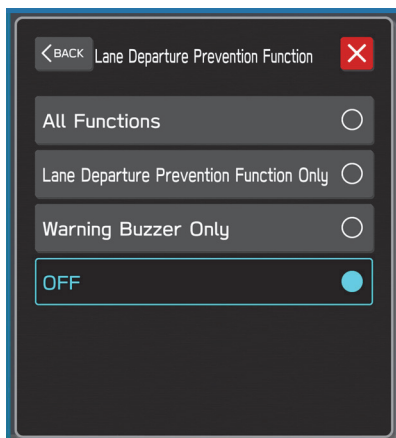

Pre-Collision Braking OFF

Select the “Car Settings” icon, then in the “Driving Assistance” menu, select “Pre-Collision Braking” to choose your desired setting for the Pre-Collision Braking functions.

When these functions are off, a yellow Pre-Collision Braking OFF indicator illuminates in the Combination Meter. It may be helpful to turn these functions off when using a drive-through carwash.

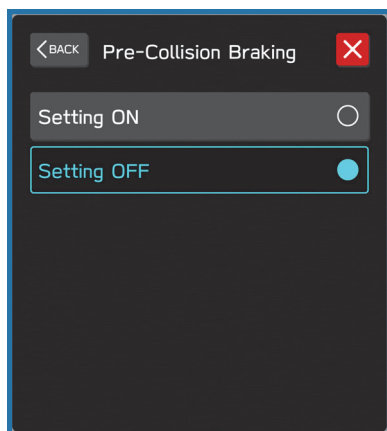

DRIVER ASSIST TECHNOLOGIES

REAR-VISION CAMERA

This function provides a clear view of the area behind the vehicle to help avoid obstacles. Using a wide-angle camera mounted on the rear of the vehicle, an image is automatically displayed on the multimedia screen when you place the select lever in the “R” position. The displayed image features a centerline indicator, colored distance markers, and dynamic guidelines that move as the steering wheel is turned.

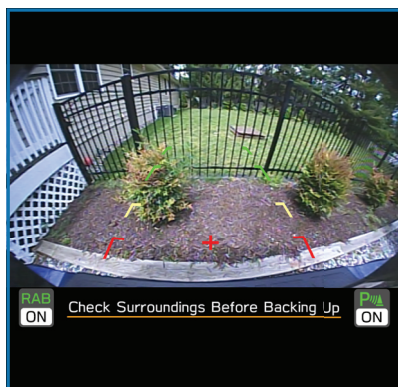

Rear-vision Camera Washer

To help keep your vision clear, your Subaru comes equipped with a Rear-vision Camera Washer. The Rear-vision Camera Washer is activated whenever the washer for the rear window is used. Rotate the end of the window wiper lever down from the “OFF” position, or up from the continuous operation position, to clean both the rear window and the Rear Vision Camera.

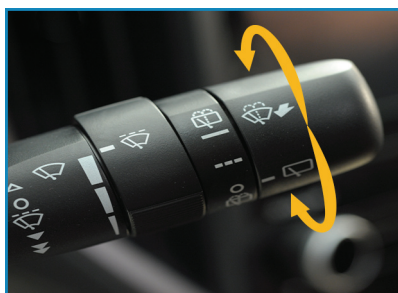

i For more information, please refer to your Owner's Manual.

DRIVER ASSIST TECHNOLOGIES

FRONT VIEW MONITOR (if equipped)

The Front View Monitor provides you with visibility from the front grille shown in the Center Information Display, improving visibility when making turns with an obstructed view or pulling into a narrow parking spot. A guide line is also displayed to provide distance and width references.

Press the Front View Monitor switch on the center console to display the Front View Monitor image on the Center Information Display (CID). You can manually turn off the Front View Monitor by pressing the Front View Monitor switch again or with the Car Settings icon, Home button, or Driver Profiles icon. The function also automatically turns off when the select lever is shifted to "P", the parking brake is applied, vehicle speed becomes 12.5 mph or more, or 3 minutes have passed since the last operation.



Front View Monitor Switch

BLIND-SPOT DETECTION (BSD)/ REAR CROSS-TRAFFIC ALERT (RCTA) (if equipped)

This system uses radar sensors mounted behind the rear bumper on the left and right sides that warn you if another vehicle is sensed in your blind spots. These functions provide additional awareness when changing lanes or driving in reverse.

Blind-Spot Detection (BSD)

This function senses if a vehicle is in your blind spot and provides a visual warning (yellow light) in the corresponding side mirror frame.



Lane Change Assist (LCA)

Lane Change Assist (LCA) works with Blind Spot Detection to provide an additional level of warning if you attempt to change lanes with a vehicle in your blind spot. LCA will rapidly flash the corresponding side mirror indicator if you operate your turn signal when a vehicle is sensed in your blind spot.

DRIVER ASSIST TECHNOLOGIES

Rear Cross-Traffic Alert (RCTA)

This function detects a vehicle approaching from either side as you reverse and provides audible and visual warnings. Warnings will appear in the upper corner of the Rear-Vision Camera display and side mirrors, and audible beeping will sound.



BSD/RCTA can be turned on or off in the Center Information Display (CID):

- 1 Select the "Car Settings" icon.
- 2 In the "Driving Assistance" menu, select "BSD/RCTA" to turn the function on or off.

When this function is off, a yellow BSD/RCTA OFF indicator will be displayed in Combination Meter Display (CMD).

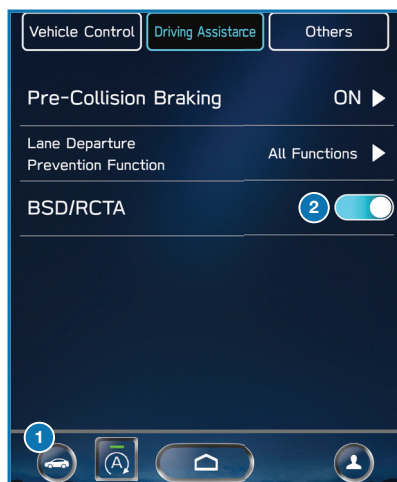

HIGH BEAM ASSIST (HBA)

This function uses the EyeSight® cameras to automatically switch the headlights between high and low beam settings when an oncoming vehicle is detected, enhancing safety for both you and other drivers on the road.



To activate High Beam Assist, set the headlight control switch to the "AUTO" position and push the headlight lever forward to the high beam position. The green HBA indicator will illuminate on the Combination Meter Display (CMD). When vehicle speed is above approximately 20 mph, HBA will automatically switch between high and low beams. When the high beams are activated, the blue high beam indicator will be displayed in the Combination Meter.

DRIVER ASSIST TECHNOLOGIES

STEERING RESPONSIVE HEADLIGHTS (SRH)

The Steering Responsive Headlights (SRH) system aims the headlight beams in the direction you are steering, improving visibility at corners and intersections when driving at night. You can turn the SRH system on or off in the Center Information Display through the “Car Settings” icon.

REVERSE AUTOMATIC BRAKING (RAB) (if equipped)

This system uses four rear bumper mounted sonar sensors to detect objects when moving between 1 and 9 mph in reverse. RAB uses the Rear-Vision Camera image to display colored proximity alerts when an object is detected. As an object becomes closer to the rear of your vehicle, audible beeps provide additional awareness in three progressive levels. If RAB determines that a collision with an object is possible, the system can automatically apply the brakes to help prevent or minimize the impact.

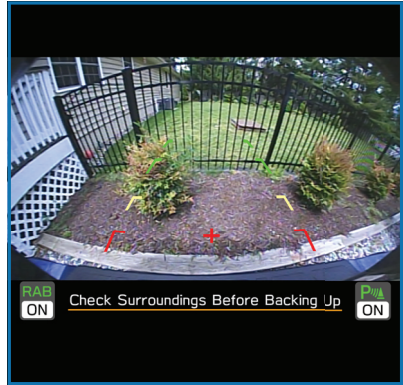

In some cases, such as connecting a trailer, it may be helpful to temporarily turn the system off. RAB can be turned off using the Touchscreen buttons on the lower corners when the select lever is in the “R” position.

Select and hold the “RAB ON” button in the lower part of the Touchscreen until it changes to “RAB OFF” to disable the automatic braking functions of the RAB system.



Select and hold the “P))) ON” button in the lower part of the Touchscreen until it changes to “P))) OFF” to disable the audible beeping of the RAB system.



DRIVERFOCUS DISTRACTION MITIGATION SYSTEM

DRIVERFOCUS® OVERVIEW (if equipped)

Your Subaru features DriverFocus®, a state-of-the-art system that helps reduce distracted driving for both new and experienced drivers.

Working with our award-winning EyeSight® Driver Assist Technology, DriverFocus® is like having an attentive co-pilot along for the ride, available to give a helpful alert if a driver becomes distracted or drowsy. For added convenience, DriverFocus® can also recognize up to five drivers and remember their preferences, such as seat position, climate settings, and outside mirror positions.

 For more information, please refer to “Driver Monitoring System” in your Owner’s Manual.

DRIVERFOCUS® COMPONENTS

Camera

DriverFocus uses a near-infrared camera to focus on the driver’s eyes and head positions.

Center Information Display (CID)

The Center Information Display (CID) is used to register and delete users. Navigate the CID screens using the touch input on the CID screen.



DRIVERFOCUS DISTRACTION MITIGATION SYSTEM

Combination Meter Display (CMD)

The CMD provides audible signals, visual alerts, and reminders in the event you become drowsy or distracted. DriverFocus® status is also displayed in the CMD. The Status Icons Chart below explains the status icons.

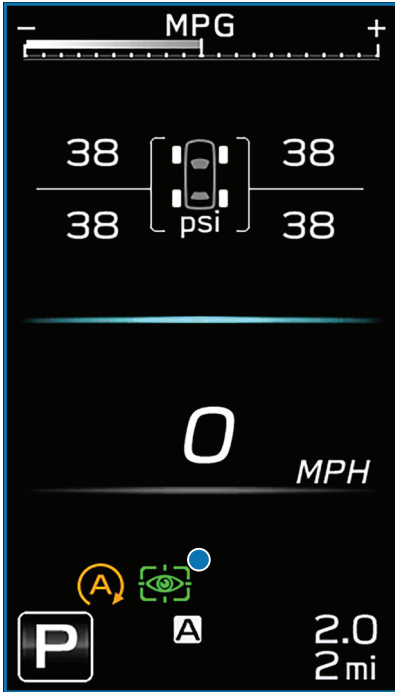

CMD

Status Icon	Indication
	DriverFocus is actively operating
	OFF (Switch was pressed)
	Temporary Stop (See Owner's Manual)
	Malfunction (Contact your Subaru Retailer)

Status Icons Chart

DRIVERFOCUS DISTRACTION MITIGATION SYSTEM

DROWSY/INATTENTIVE WARNINGS

DriverFocus[®] detects when the driver is possibly not paying attention or is becoming drowsy while driving. It works whether you are a registered user or not. The system does not provide alerts when the turn signals are operating or when the select lever is in the “R” position.

When the system perceives the driver is not paying attention, the “Keep Eyes on Road” warning will appear in the CMD along with three rapid beeps.

When the system perceives drowsy driving, various warnings will appear in the CMD along with beeps.



DRIVER PROFILE/CONVENIENCE SETTINGS

You can take advantage of convenience settings by becoming a registered driver. Preferences such as seat and side mirror memory settings, as well as some features in the Center Information Display (CID) and climate control, are uniquely linked to you.

Registering a Driver

1. With the ignition on, select “Settings” in the Center Information Display (CID).
2. In the tabs at the top of the screen, select “Car”.
3. Select “Driver Monitoring System”.
4. From the Driver Monitoring System menu, select “Register User” to add a new driver. Up to five drivers can be registered.
5. Select an open space 1-5.
6. Adjust the seat and door mirrors to your desired positions and select “Set”.
7. Face forward until you hear a beep.
NOTE: The system does not save images, audio or video.
8. Input your name and choose from an available icon.
9. Select “Set” to finish registration.

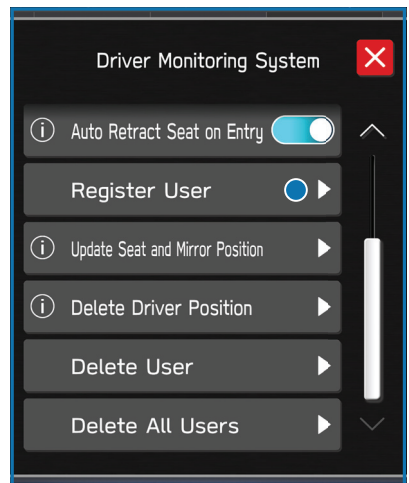

DRIVERFOCUS DISTRACTION MITIGATION SYSTEM

Recognizing a Driver

DriverFocus® will scan and recognize you as soon as you enter the vehicle. The Combination Meter Display will show a welcome screen with your user name and personal icon. The vehicle will also recall your user settings, such as driver seat and side mirror positions.

If the system does not automatically recognize a registered driver, you can repeat the facial scan by selecting "Settings", then selecting the "Car" menu. Select "Driver Monitoring System", then "Repeat Facial Scan".

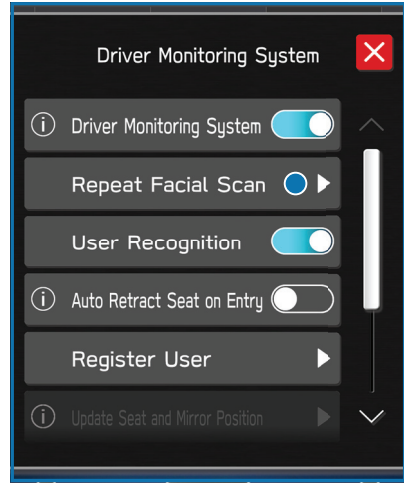

Deleting a Driver

1. With the ignition on, select "Settings" in the Center Information Display (CID).
2. In the tabs at the top of the screen, select "Car".
3. Select "Driver Monitoring System".
4. Scroll down and select "Delete User".
5. Select the driver you want to delete and select "Yes".

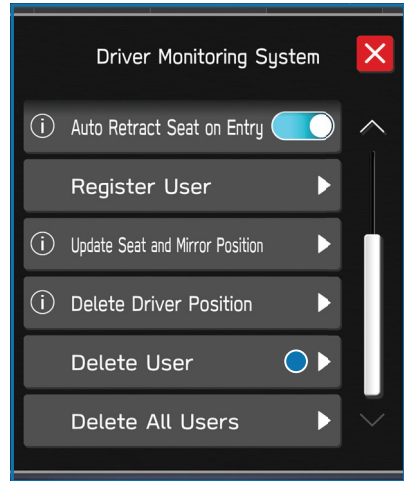

DRIVER MONITORING SYSTEM OFF

The Center Information Display (CID) is used to turn the DriverFocus system off or on and to customize settings. From the Home Screen, select “Settings”, “Car”, and then “Driver Monitoring System” to turn the system on or off and adjust settings.

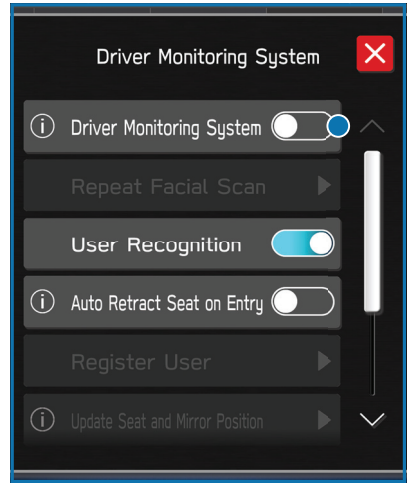

CARE AND LIMITATIONS

STEREO CAMERA PRECAUTIONS

Your EyeSight® stereo cameras are precision components that must be kept free from obstruction and contamination, such as fingerprints or cleaning solutions. When the system detects that the stereo camera lenses are impaired, a malfunction indicator will be displayed and EyeSight® functions will not be available.

When you are in the vicinity of the EyeSight® stereo cameras, always observe the following precautions:

- Do not touch or attempt to clean the EyeSight® camera lenses inside the vehicle. Extra caution should be used when cleaning the inside of the windshield. Over-spray from cleaning solutions may impair or even damage the camera lenses. Please inform others who may attempt to clean the windshield, such as car wash staff, of this precaution.
- Electronic Toll Collection devices, such as EZPass™, must be installed in an area that does not obstruct the stereo cameras' field of vision. See "Prohibited Area" on page 121.
- Adjust the rearview mirror so it does not obstruct the stereo cameras' field of vision.
- Do not install any interior rearview mirror accessories, such as a wide-type mirror or hanging objects. Only approved Genuine SUBARU accessories may be installed.

 For more detailed information, please refer to your EyeSight® Owner's Manual.

WINDSHIELD GLASS AND DASHBOARD

Since the characteristics and limitations of the EyeSight® stereo cameras are similar to human eyes, it is important that the area in front of the cameras be kept free from dirt, scratches, cracks, fogging, or accessories mounted to the windshield, hood or dashboard. Visual impairments or reflections can affect EyeSight® system performance. Extra caution should be taken when cleaning the windshield to prevent over-spray from cleaning solutions.

The image in the following section outlines those areas that must be kept clean and free from obstruction. Please refer to the Owner's Manual for a complete listing of limitations.

OUTBACK

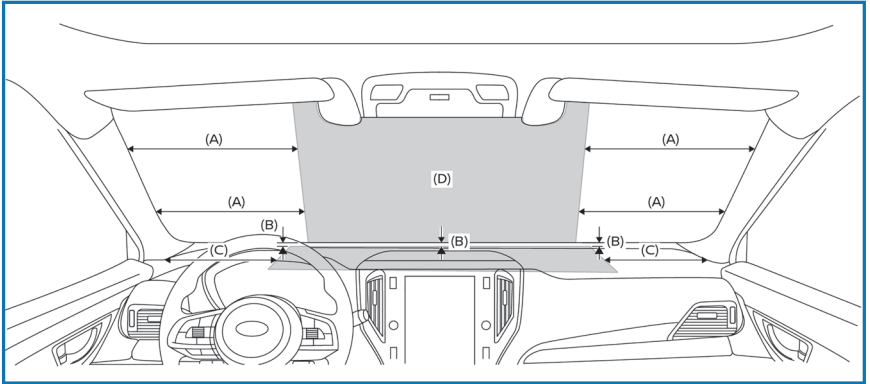

(A) 12.99 in (330 mm)
(B) 4.8 in (122 mm)

(C) 10.91 in (277 mm)
(D) Prohibited area (in gray)

EYESIGHT DISCLAIMER

EYESIGHT® DISCLAIMER

EyeSight® is a driver assist technology which may not operate optimally under all driving conditions. The driver is always responsible for safe and attentive driving. System effectiveness depends on many factors such as vehicle maintenance, weather and road conditions. See Owner's Manual for complete details on system operations and limitations.

The Pre-Collision Braking system is designed to provide automatic braking that either prevents a collision or reduces the severity of a frontal impact.

The Pre-Collision Throttle Management system is designed to reduce acceleration and minimize the severity of certain frontal impacts.

Advanced Adaptive Cruise Control and Brake Light Recognition are designed to assist the driver and are not substitutes for safe and attentive driving.

Lane Centering function operates only when used in conjunction with Advanced Adaptive Cruise Control.

Lane Departure Prevention operates only when the lane markings are visible, and system effectiveness depends on many factors.

Blind-Spot Detection, Lane Change Assist and Rear Cross Traffic Alert are systems designed to assist the driver by monitoring the rear and side areas of the vehicle during a lane change or reversing and are not a substitute for safe and attentive driving.

The Reverse Automatic Braking System is not a substitute for safe and attentive driving. System effectiveness depends on many factors, such as vehicle maintenance, weather and road conditions. Always exercise caution and use vehicle mirrors and the Rear-Vision Camera when backing up. See Owner's Manual for complete details on system operation and limitations.

The Driver Focus Distraction Mitigation System is a driver recognition technology designed to alert drivers if their attention to the road wavers or if the driver's face appears to turn away. The driver is always responsible for safe and attentive driving. System effectiveness may be affected by articles of clothing worn on the head or face. See Owner's Manual for complete details on system operation and limitations.

HOW TO OVERVIEW

This “How To” appendix provides detailed, step-by-step instructions to easily connect with features of your Outback.

If you need some help with these features or want to learn more, we are here to assist you:

Your Subaru Owner’s Manuals:

Located in the glovebox

Online Subaru Owner’s Resources:

www.subaru.com/owners

Subaru Customer Support:

www.subaru.com/customer-support

1-800-782-2783 (1-800-SUBARU3)



Scan to learn more
about **Owner's
Resources.**



Scan to learn more
about **Customer
Support.**

SETTING THE CLOCK

Clock settings can be adjusted when the ignition is in the “ON” position. You can adjust the clock manually or set the clock to adjust automatically in the clock setting screen. To directly access the clock setting screen, you can select the clock on the status bar at the top of the Center Information Display. Full directions for accessing the clock settings and adjusting the clock manually or automatically are given below.

 For more information, please refer to “Basic Functions” in the STARLINK® Owner’s Manual.

HOW TO APPENDIX

Manually

To set the clock manually:

- 1 Select the Clock Display in the Status Bar.

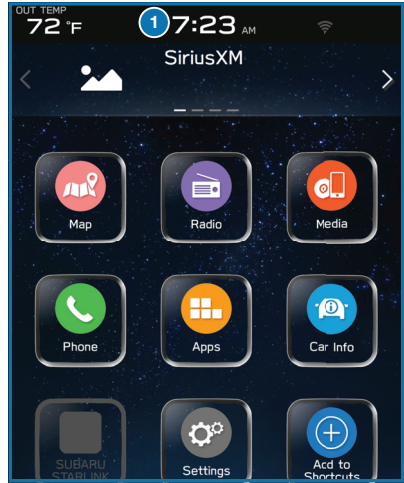

- 2 Select "Time Setting".

NOTE: On this screen, you can also adjust the clock format (12H or 24H) and, for vehicles with navigation, adjust the time zone and Daylight Saving Time. The recommended settings for these are "Auto."

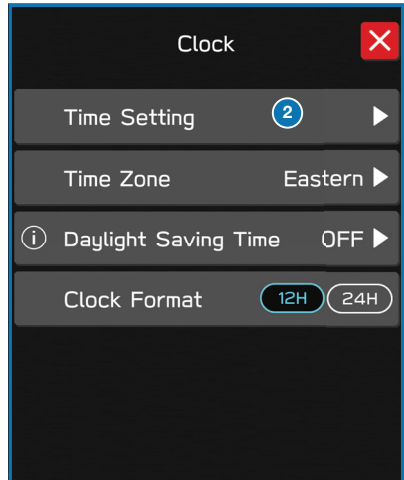

HOW TO APPENDIX

- 3 Select "Manual".
- 4 Adjust the time and date using the "Arrow Up" and "Arrow Down" buttons.
- 5 Once you are finished, select "OK".

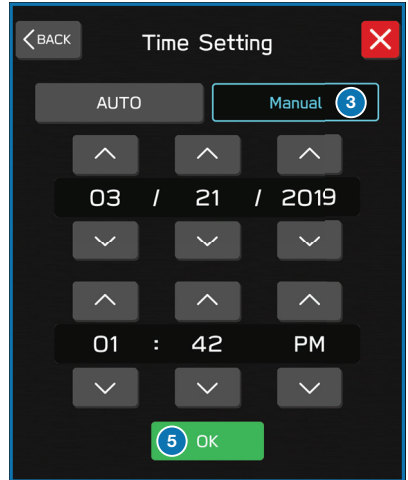

HOW TO APPENDIX

Automatically

To set the clock automatically:

- 1 Select the Clock Display in the Status Bar.



- 2 Select "Time Setting".

NOTE: On this screen, you can also adjust the clock format (12H or 24H) and, for vehicles with navigation, adjust the time zone and Daylight Saving Time. The recommended settings for these are "Auto."

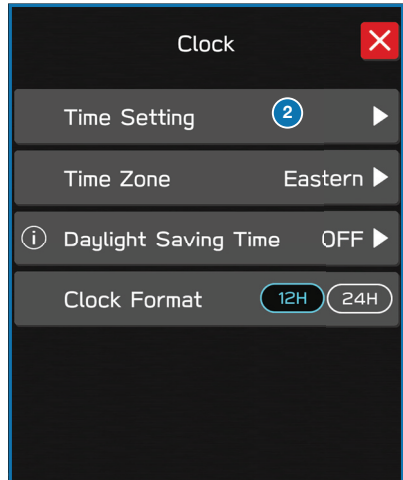

HOW TO APPENDIX

- 3 For 11.6-inch display models, select “Auto”. For Dual 7.0-inch display models, select “Sync With Phone”.
- 4 Select “Back”.

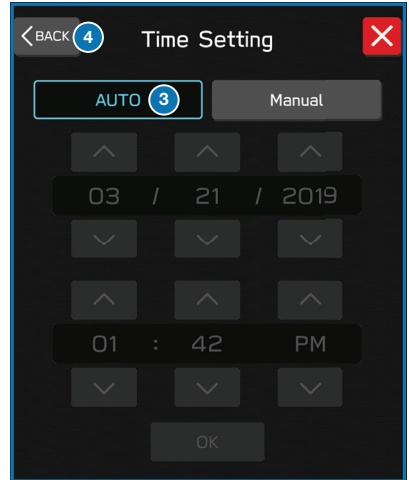

The clock automatically adjusts as follows:

- 11.6-inch display with navigation system: Automatically adjusts the clock when a GPS signal is available.
- 11.6-inch display without navigation system: Automatically adjusts the clock when a STARLINK® Safety and Security signal is available.
- Dual 7.0-inch display: Automatically adjusts the clock when a phone is paired and connected via Bluetooth®. “Phonebook Download” must be enabled in the Phone Settings.

For step-by-step procedure to pair a phone to the SUBARU STARLINK® Touchscreen, see page 130 for Android devices or page 133 for Apple devices.

HOW TO APPENDIX

MEMORY HEIGHT (if equipped)

With the Memory Height function, you can set where the Power Rear Gate stops when it opens. This is a great feature to limit the upward travel of the rear gate to ensure you can reach it or to prevent the rear gate from contacting a garage ceiling.

To set the height:

- 1 In the Center Information Display (CID) press the “Home” Button.
- 2 Select “Settings”.
- 3 Select “Car”.
- 4 Select “Power Rear Gate”.

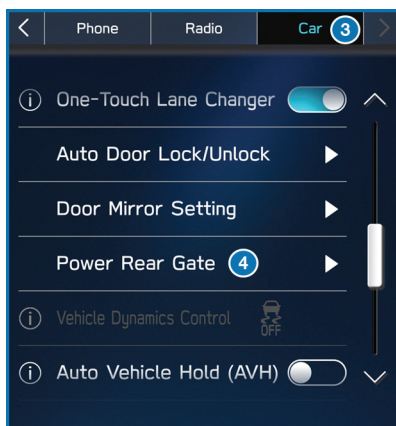

- 5 Turn on “Power Rear Gate Memory”.

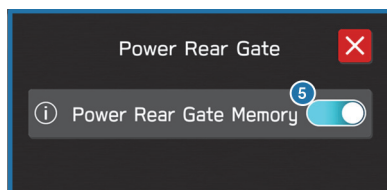

- 6 Open the rear gate using the Power Rear Gate Button. Pause the rear gate when it reaches the desired height by pressing the Power Rear Gate Button on the rear gate, instrument panel, or key fob.



- 7 With the rear gate at the desired height, press and hold the Power Rear Gate Close Button on the inside edge of the rear gate. A chirp will sound and the hazard warning lights will flash to confirm the height is set.



When “Power Rear Gate Memory” is enabled on in the Center Information Display (CID), the rear gate will stop at the set memory height when you use any of the Power Rear Gate switches.

NOTE: To adjust the memory height, perform the registering procedure again.

MEMORY DRIVER'S SEAT (if equipped)

You can set a seat position and retrieve it using the buttons on the driver's door or the access key fob.

To set a seat position with a button:

1. Make sure the select lever is in the “P” position, with the parking brake applied and the ignition in the “ON” position.
2. Adjust the seat to the desired position.
3. While holding the “SET” button, press and hold either button “1” or “2”. A chirp sounds when the position is registered.



Memory Seat Buttons

To retrieve the seat position set with a button:

1. Turn the ignition switch to “ON”.
2. Put the select lever is in the “P” position and apply the parking brake. Then, press button “1” or “2”.

HOW TO APPENDIX

To set a seat position with the access key fob:

1. Make sure the select lever is in the “P” position with the parking brake applied and the ignition “OFF”.
2. Adjust the seat to the desired position.
3. While holding the “SET” button, press and hold the unlock button on the access key fob. A chirp sounds when the position is registered.

To retrieve the seat position set with the access key fob:

1. Hold the access key fob.
2. Unlock and open the driver’s door.

BLUETOOTH® PAIRING

Pairing an Android Device

- 1 To pair an Android device, start by touching the “Phone” button on the Home screen.



- 2 If there is no phone connected, it will ask you, “Do you want to add a device?”. Select “Yes”. If a device has already been paired, select “Add Device”.

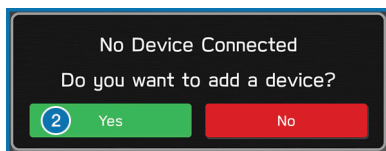

HOW TO APPENDIX

- 3 The screen to the right will be displayed when pairing mode is in progress. The device name will most likely be Subaru, but be sure to make note of what name it is so you can find it on your phone.

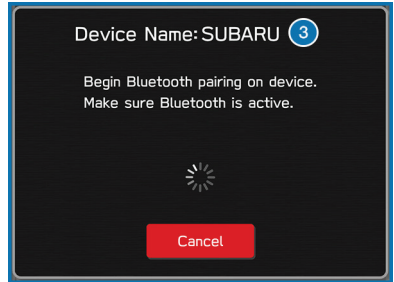

- 4 On your Android device, go to "Settings" (it can be found under apps).
- 5 Next select "Connected Devices" or "Connections".

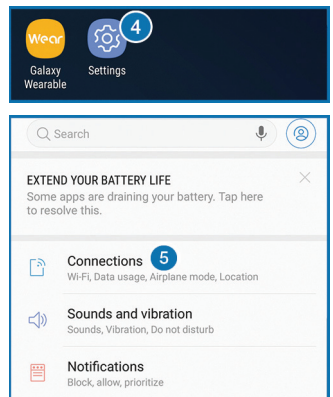

- 6 Now select "Bluetooth". This will show a screen to "Pair New Device" or it will be showing the nearby devices to add. Select "Subaru", if shown on the list, or "Pair New Device".

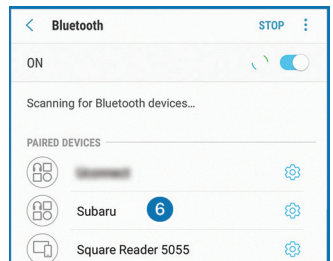
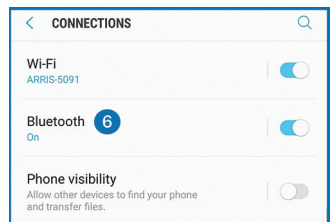

HOW TO APPENDIX

- 7 Now select “OK” to pair the devices. Make sure to allow access to your messages and call history in the “Allow Access to Messages” popup box.

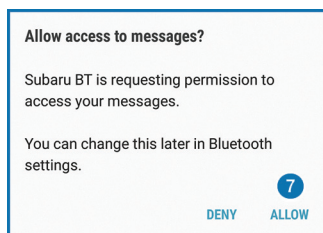
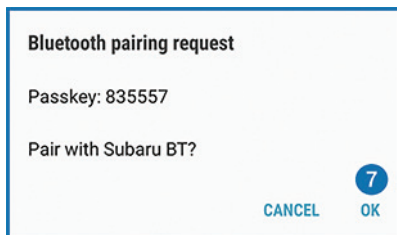

- 8 Select “Yes” to transfer your contacts.

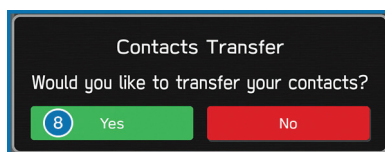

- 9 If you cannot access your phonebook or messages, go back to your phone’s Bluetooth® settings and select the gear icon next to your vehicle’s device name and ensure all settings are enabled.

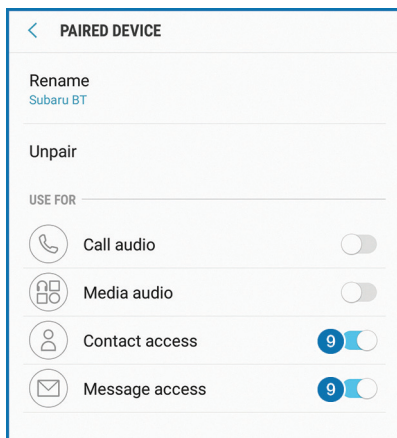

Pairing an iOS/Apple Device

- 1 To pair an Apple device, start by touching the “Phone” button on the Home screen.

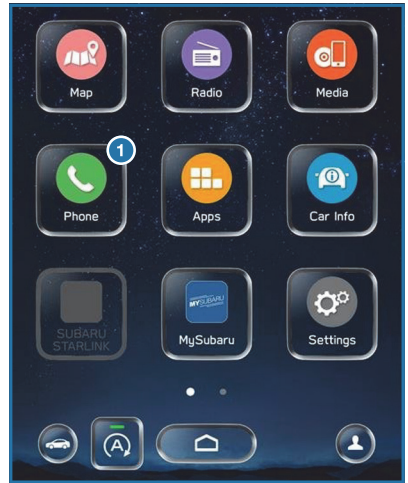

- 2 If there is no phone connected, it will ask you, “Do you want to add a device?”. Select “Yes”. If a device has already been paired, select “Add Device”.

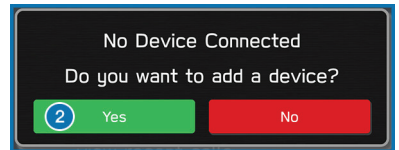

- 3 When this screen is displayed, it is in pairing mode. Note the “Device Name”; it will most likely be “Subaru”.

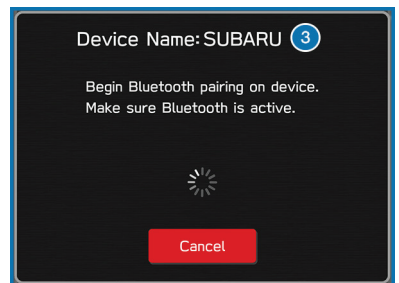

- 4 On your iOS/Apple device, select “Settings”. The location on the Home screen will vary.

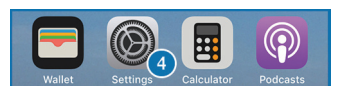

HOW TO APPENDIX

- 5 Select “Bluetooth”.

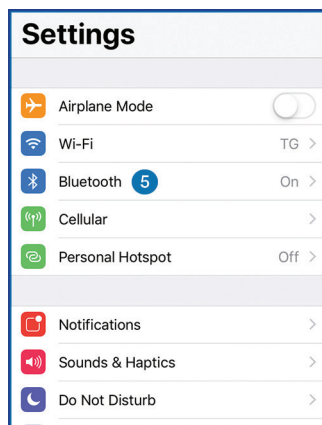

- 6 Now select “Subaru”, or the device name from step 3, if not “Subaru”.

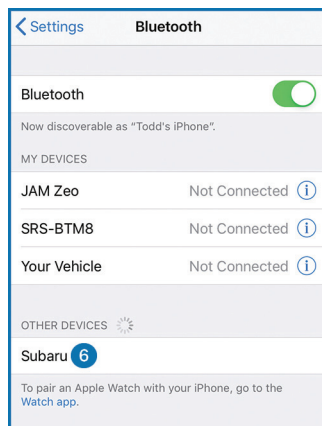

HOW TO APPENDIX

- 7 Verify your iOS/Apple device PIN is correct and select “Pair”. Then select “Allow” on the “Allow Contacts and Favorites Sync?” screen.

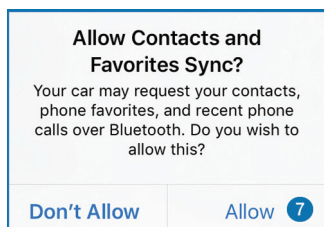
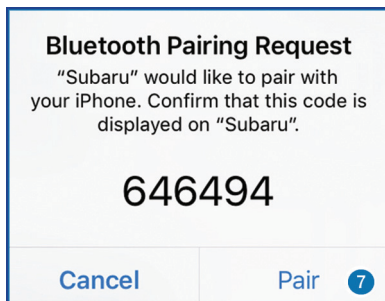

- 8 Select “Yes” to transfer contacts.

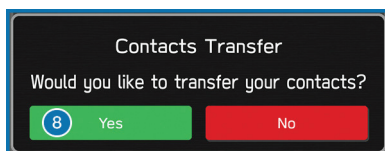

- 9 On your iOS/Apple device, Subaru should now be listed under “Bluetooth Settings”. Select the blue “i” next to the device name. Then ensure “Show Notifications” and “Sync Contacts” are enabled.
- 10 Your iOS/Apple device is now paired. It is recommended that you restart your Subaru to complete the process and ensure everything is fully synced.

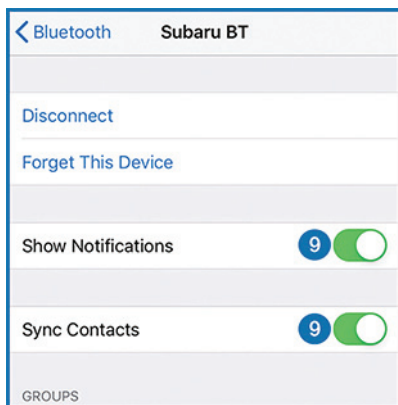

HOW TO APPENDIX

ANDROID AUTO™

Cables

Always use a high-quality OEM USB cable.

Ensure the Android phone is fully up to date. Also verify that the Android Auto™ app, along with all other apps that work with Android Auto™, are up to date. Android Auto™ might not function properly if one of them is outdated or having an issue. The apps can be downloaded from the Play Store.

 For more information, visit www.android.com/auto/



Scan to learn more about
Android Auto

Connecting an Android Phone

- 1** To set up Android Auto™, first plug the Android phone into the USB port of the vehicle using a quality OEM cable. Following the prompts on your phone, select "Accept", "Continue", or "Allow" as needed to complete the setup.
- 2** Once setup is complete, select the Android Auto™ button on the Center Information Display to open and use the application.
- 3** If Android Auto won't launch, open the Android Auto™ app on your phone, then select the menu button on the top left. Select "Settings", then "Connected Cars". Finally select the menu icon in the top right and choose "Forget all cars". Re-try the setup process.

If this does not work, uninstall the Android Auto™ app from the phone and reinstall from the Play Store.

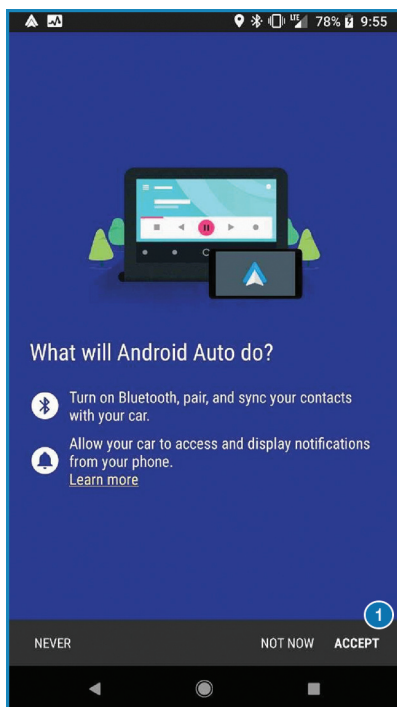

Compatible Models

Android Auto™ is available on Android phones. To see if your phone is compatible, please refer to the Android Auto™ website:
<https://www.android.com/phones/>



Scan to see if
your phone is
compatible with
Android Auto

APPLE CARPLAY®

Cables

Apple CarPlay® requires compatible iPhones to be connected via your Subaru's USB port. Cables must be an 8-Pin Lightning MFi Certified cable (made for iPod/iPhone). Look for the "Works with Apple CarPlay®" or "Made for iPod, iPhone, iPad" icons when selecting a cable.

 For more information, visit: www.apple.com/ios/carplay/



Scan to learn
more about
Apple CarPlay

HOW TO APPENDIX

Connecting an iPhone

1. To set up Apple CarPlay®, make sure Siri is turned on then plug the iOS/Apple phone into the USB port of the vehicle. Make sure to use an MFi certified cable.
2. Select “Allow” on the iOS/Apple phone when prompted.
3. Select Apple CarPlay® on the vehicle screen. This will bring you to the home page of your phone in Apple CarPlay®.

Ensure the iOS/Apple phone is fully up to date. Also ensure all apps that work on Apple CarPlay® are up to date. Apple CarPlay® might not function correctly if one of the apps is outdated or having an issue. Apps can be updated in the App Store.

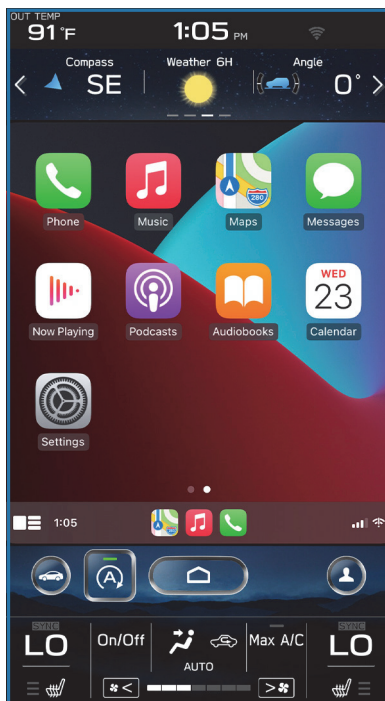

Compatible Models

For a list of all the Apple phones that are compatible with Apple CarPlay®, visit: www.apple.com/ios/carplay/



Scan to learn more about Apple CarPlay

WI-FI

Connecting to a Wi-Fi Network

- 1 On the Home Screen, select “Settings”.
- 2 In the “General” settings menu, select “Wi-Fi”.

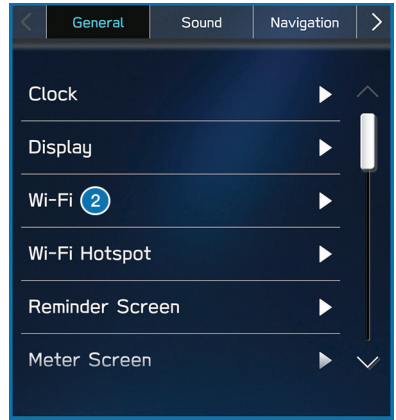

- 3 Make sure that Wi-Fi is enabled, then select “Available Wi-Fi Networks”.



HOW TO APPENDIX

- 4 Select the desired network. When selecting a network with the lock icon, a screen will appear for you to enter the password, then select OK.

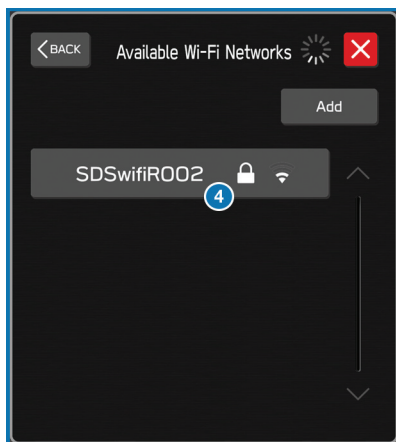

Wi-Fi Hotspot Subscription

Internet access is purchased separately through AT&T with monthly, per gigabyte, and unlimited data options available. Existing AT&T customers have the option to add an additional line to their AT&T Mobile Share plan. Available on select models.

Shortly after you take delivery of your new Subaru, you will receive an email from AT&T for a one month free trial and how to activate your free trial. To set up and enroll:

1. Select "Settings" on the Home screen.
2. Select "Wi-Fi Hotspot" to turn it on (if the Wi-Fi Hotspot is already on then proceed to the next step).
3. Select Wi-Fi Hotspot Settings to view or update the following settings:
 - Wi-Fi Network Name (SSID)
 - SSID Broadcast (Network ON / OFF)
 - Security Type (WPA / WPA2)
 - Password
 - Connected Devices (Maximum of 8 devices)



Scan to learn more about AT&T plans

How to enroll:

1. Connect your tablet, smartphone or laptop to the SUBARU STARLINK® Wi-Fi Hotspot network listed in the settings menu and open your preferred web browser on the device connected.
2. Once the SUBARU STARLINK® Wi-Fi Hotspot homepage loads, follow the on-screen instructions to create a new account or to add your vehicle to an already existing AT&T Wireless account. You can also subscribe to the Wi-Fi Hotspot from the MySubaru website or Mobile App.

 You can also visit an AT&T store or their website for more information at:
<https://www.att.com/plans/connected-car/subaru.html>

HOW TO APPENDIX

MAPS (if equipped)

Creating Home/Work

You can create a home address and work address through the Map screen.

- 1 Select the “Map” button from the Home screen.

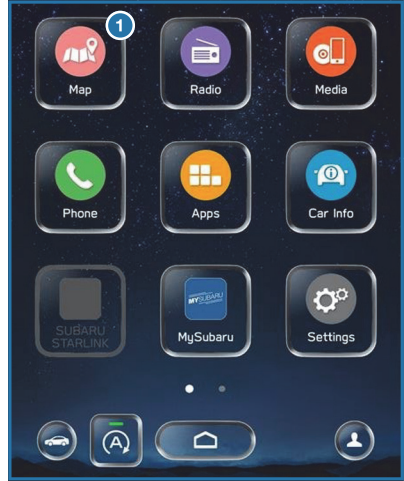

- 2 Select “Menu”.

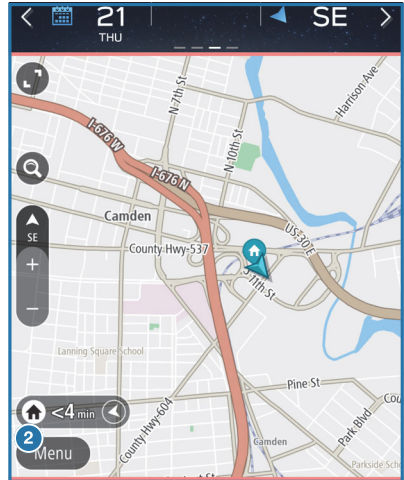

HOW TO APPENDIX

- 3 Select "Favorites".

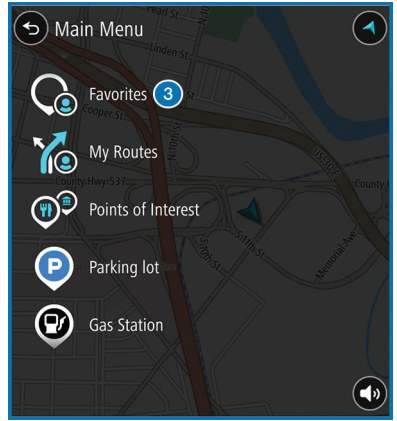

- 4 Select "Add Home" or "Add Work".

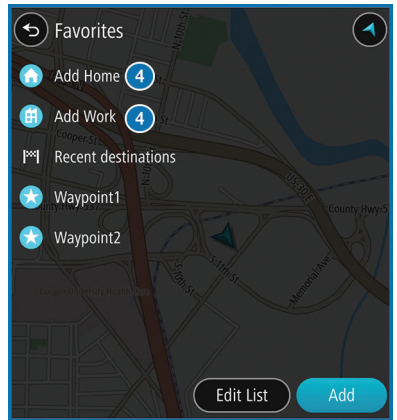

HOW TO APPENDIX

- 5 Select “Search”.

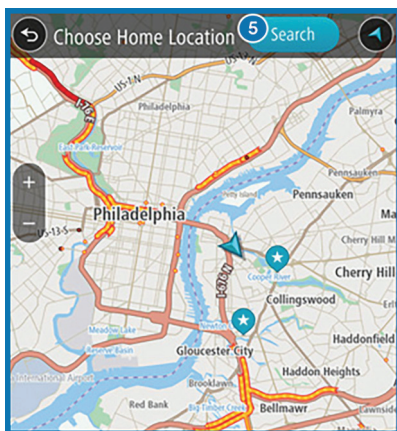

- 6 Type in the address. As you type, suggestions will display. Once your address is displayed, select your address.

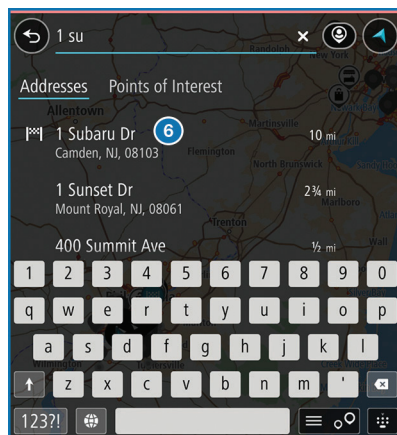

HOW TO APPENDIX

- 7 Select the “Work” or “Home” icon to save as work or home.

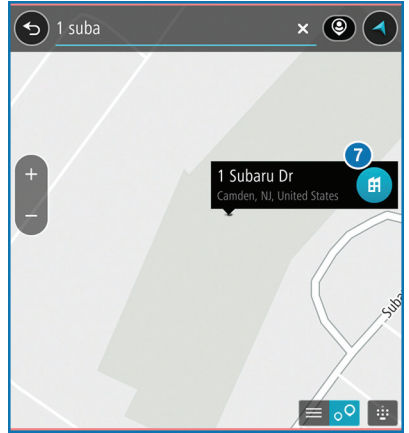

HOW TO APPENDIX

Finding a Destination By Address

To search by address:

- 1 Start by pushing the “Map” button to display the map screen.

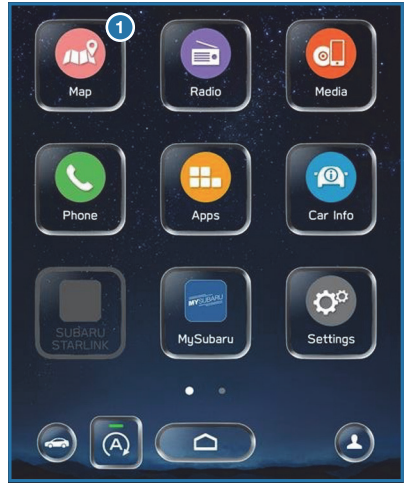

- 2 Select “Menu”.

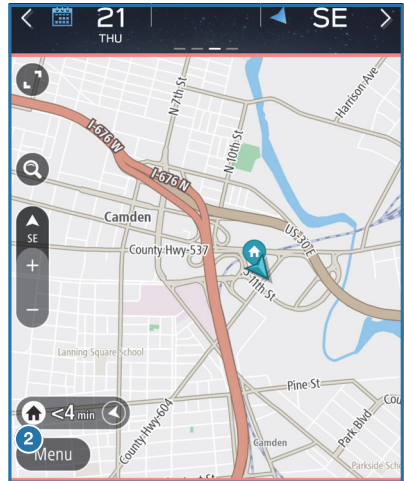

HOW TO APPENDIX

- 3 Next, select “Search”.

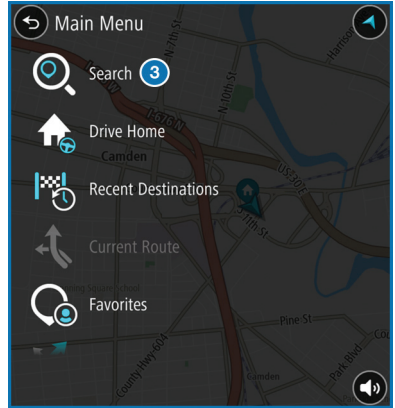

- 4 Select “Addresses” if it is not already selected and type the address.
 - a. Selecting this icon will display the current vehicle location.
 - b. Selecting this icon allows you to set the search radius filter. Once the filter is set, the search will only be performed for items within the chosen option: Whole Map, Near Me, In Town or City, Along Route, Near Destination, or Latitude/Longitude. You may need to change the setting if your destination is beyond the scope of the search radius filter.

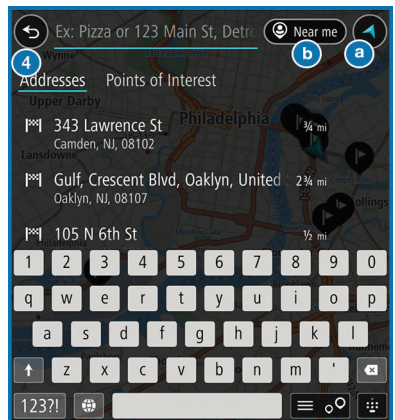

NOTE: You can toggle between “Address” and “Point Of Interest” search by selecting the one you want.

- 5 When the address appears on the screen select it.

HOW TO APPENDIX

- 6 Select “Go”. After selecting “Go”, you can customize your search by using the Search Radius Filter feature or add stopping points, called Way Points, along your route.

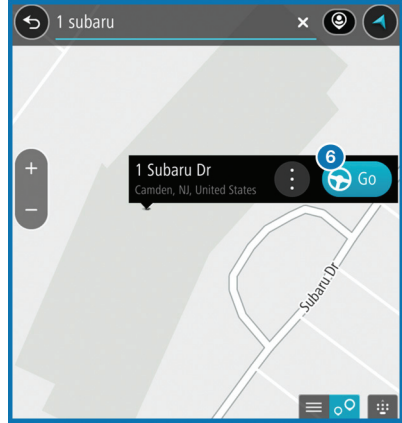

- 7 Select “Let’s Go” to start navigating to the address. You will see fuel stations, rest stops, hotels, etc. on the right side of the screen.

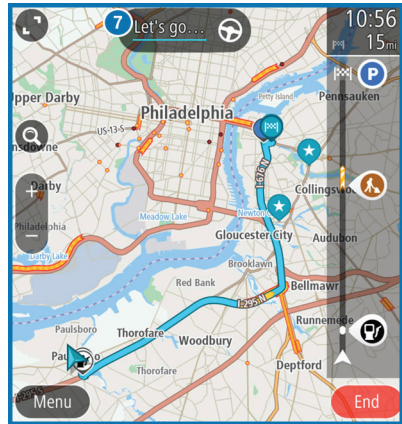

Finding a Destination By POI

You can search by Points Of Interest (POI) using the search function or with the Points Of Interest button. To search by Points Of Interest (POI):

- 1 Push the “Map” button to display the map screen.



- 2 Then select “Menu”.

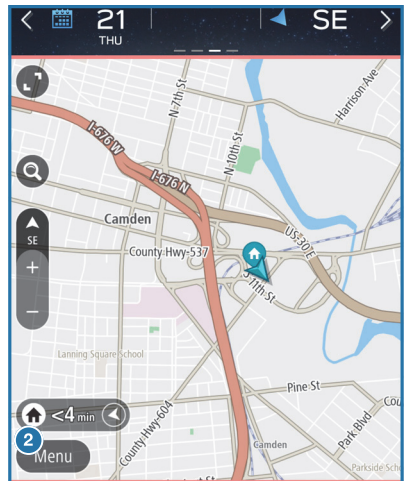

HOW TO APPENDIX

3 Next, select “Search”.

4 Select “Points of Interest”.

NOTE: You can toggle between “Address” and “Point Of Interest” search by selecting the one you want.

5 Type the name of the destination you are looking for or a general category (e.g., restaurant or park). Results will be listed below. Scroll, if needed, to find a destination. Select the desired item from the list, then select “GO”.

6 If preferred, you can instead browse points of interest by selecting “Menu”, then selecting “Points Of Interest”. Categories will be listed alphabetically. Select a category from the list. Select a destination, then select “GO”.

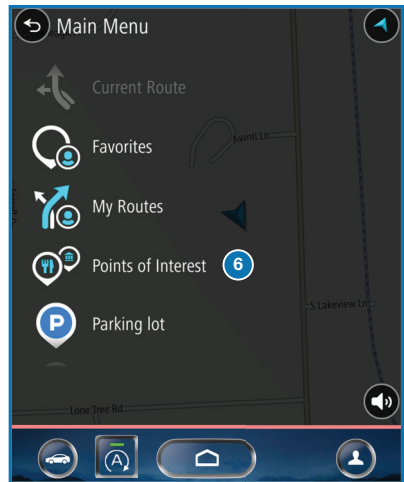
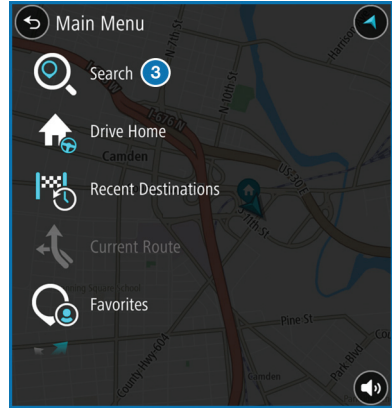

HOW TO APPENDIX

- 7 Select “Let’s Go” to start navigating to the address. You will see fuel stations, rest stops, hotels, etc. on the right side of the screen.

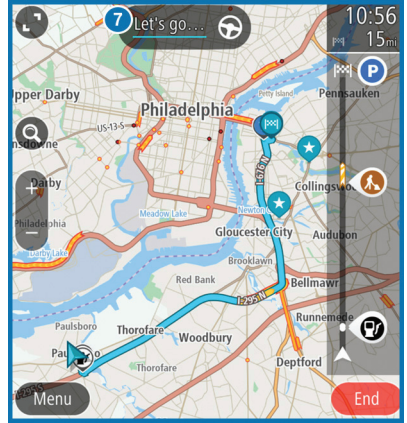

HOW TO APPENDIX

Route Options

You can set the navigation system to avoid certain types of routes:

- 1 From the “Home” screen select “Settings”, then “Navigation”.
- 2 Select “Avoid”.

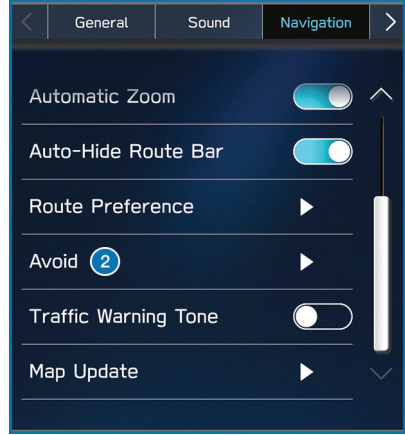

- 3 Select the desired item to avoid.

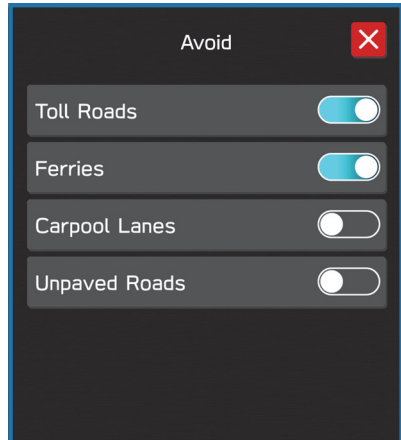

Shortest/Fastest/Economic

You can set the route preferences to search for the shortest, fastest, or most economic route or to avoid freeways. To do this:

- 1 From the "Home" screen select "Settings".
- 2 Select "Navigation".
- 3 Select "Route Preference".

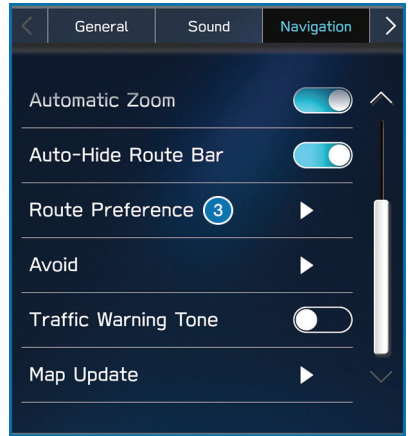

- 4 Select the preference you would like to use the most; Fastest, Shortest, Eco-Friendly or Avoid Freeways.

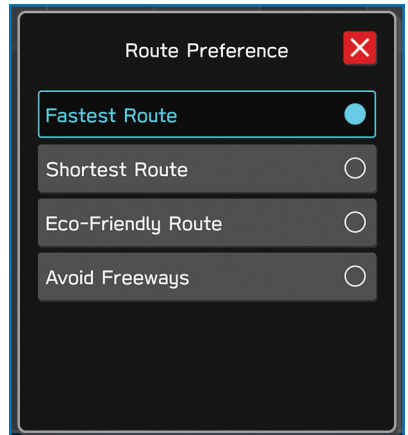

HOW TO APPENDIX

Saving Destination as a Favorite

The registered points can be set as a destination. To save a location from the Map screen:

- 1 Select "Menu".

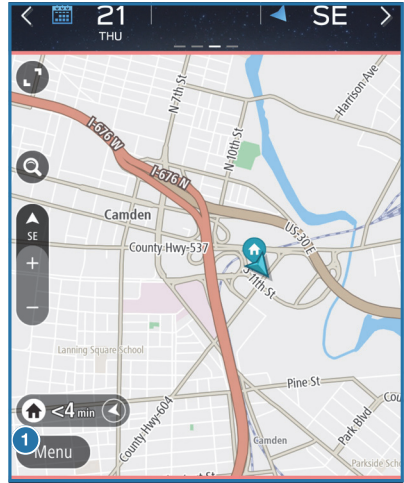

- 2 Select "Favorites".

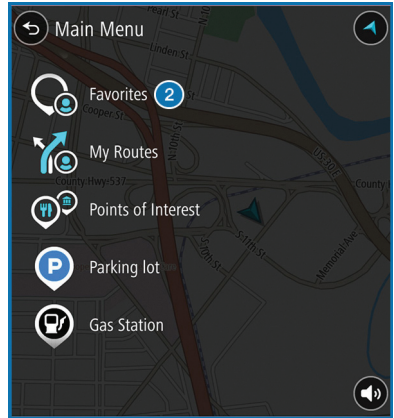

HOW TO APPENDIX

3 Select "Add".

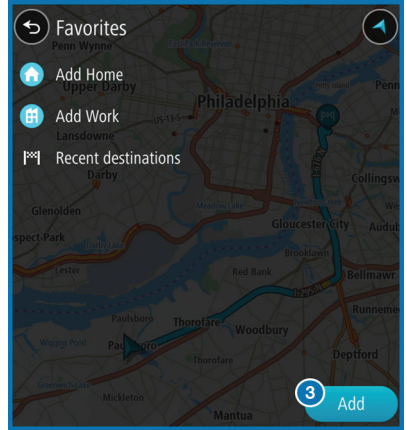

4 Select "Search".

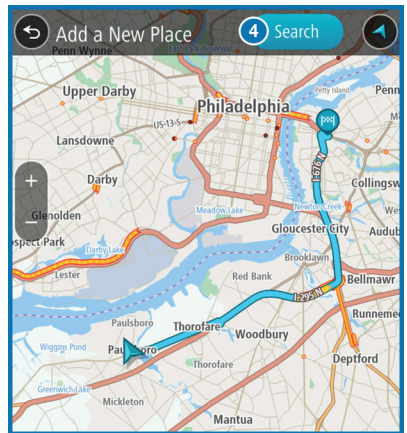

HOW TO APPENDIX

- 5 Start typing the address you want to save, select the address when it appears on the screen.

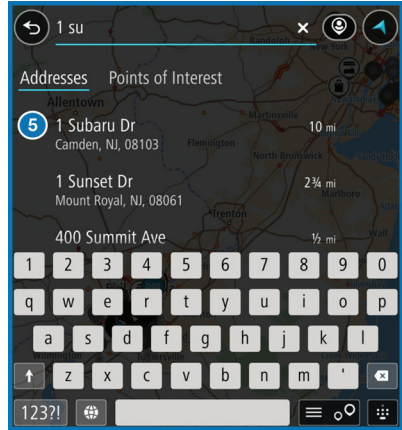



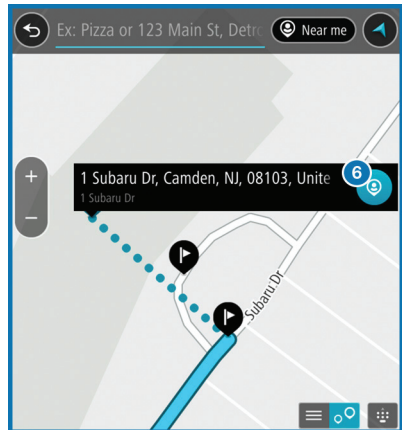





- 6 Select the icon on the address to save to favorites. You can rename the location or use the address as the location name. Select "OK" when finished.

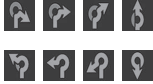

HOW TO APPENDIX

Guidance Screen Icons

These are the common icons used for the navigation guidance.

ICON	EXPLANATION	ICON	EXPLANATION
	Turn left/right.		Go straight ahead at the intersection.
	U-turn.		Exit at the junction.
	Keep left/right at the fork in the road.		Roundabout.
	Turn left/right & sharp curve.		You have arrived at your destination.
	Stay in the left/right lane.		You have arrived at your waypoint.

Map Zoom

Once on the map screen, you can zoom in or out by touching the “+” or “-” buttons on the screen. You can also use two fingers on the screen and move them apart to zoom in or together to zoom out.

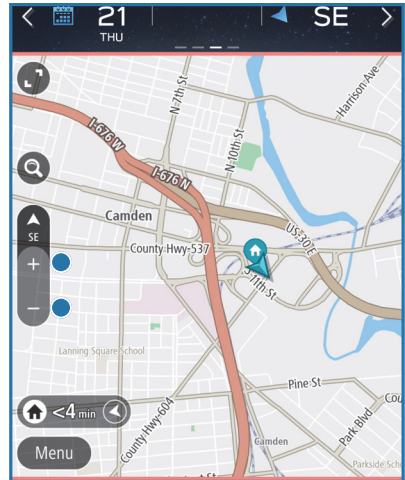

HOW TO APPENDIX

You can also enlarge the map to cover the top portion of the screen by selecting this button.

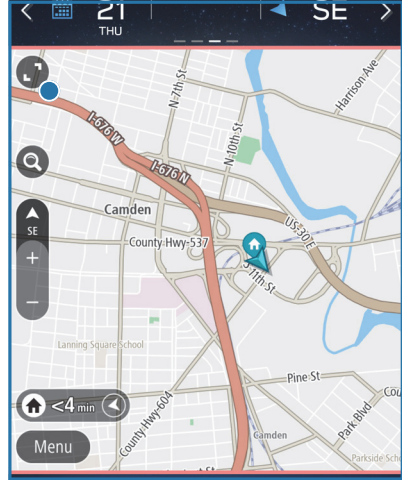

Map View/Perspectives

The orientation of the map can be changed between 2D north-up, 2D heading-up, and 3D heading-up. To change the view, select the icon above the “+” and “-” buttons. Each time the icon is touched, the view will change. The direction of the arrow indicates north when in 2D heading-up and 3D heading-up modes.

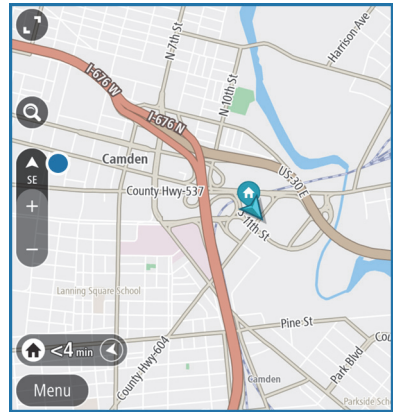

Traffic Information

Road sections affected by traffic conditions are displayed in a different color on the map, and a small icon representing the type of traffic condition is displayed above the road.

To receive the data service information in the vehicle, a subscription to the SiriusXM® Traffic Services is required following a free trial.

Nearest Gas Station

When driving on the highway during route guidance, information on gas stations, restaurants, or rest areas will be displayed on the right.

Select the desired item from the list, and then select “GO” to navigate to the closest selected place.

Arrival Distance/Time

Displays the distance to the destination and/or the estimated arrival time at the destination.

This is customizable by selecting “Settings” from the home screen, then “Navigation” and finally “Arrival Distance/Time”.

Canceling Guidance

To cancel guidance, select “End”.

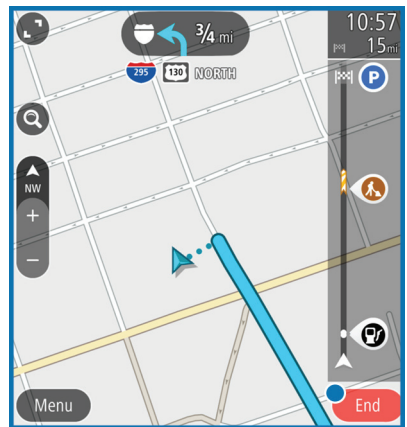

HOW TO APPENDIX

Map Updates

For vehicles with 11.6 Multimedia Plus and 11.6 Multimedia Navigation systems, the maps can be updated over a Wi-Fi network, either manually or automatically.

1 For more information, please refer to “Subaru Map Update” in the STARLINK® Owner’s Manual.

To update your maps automatically over Wi-Fi, follow this process:

- 1** First, make sure you are connected to a Wi-Fi Network (see page 139), return to “Settings”, and then select the “Navigation” menu.
- 2** Select “Map Update”, select “Wi-Fi” and then select “Automatic Update”.

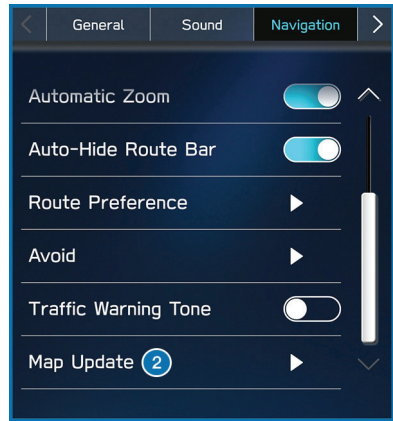

- 3** Select “Update maps automatically (at most 8 can be selected)” and then select the regions you would like to update.

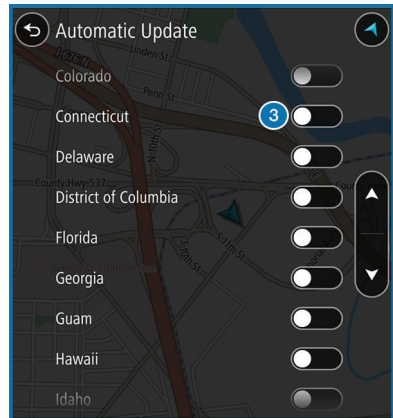

FIRMWARE AND SOFTWARE UPDATES

Software updates provide enhancements to the system, such as new features, added security, and upgraded functions. You can ask your preferred Subaru retailer to check for and perform a full update to the system software. Please ask your preferred Subaru retailer for specific details on update content.

For the 11.6-inch Multimedia Plus and the 11.6-inch Multimedia Navigation systems, some system software can be updated via a Wi-Fi network. The update process involves downloading and installing the software update.

NOTE: System functionality will be restricted during installation, and you may need to reset radio station presets and volume settings after the update process. Set your clock to “Auto” (see page 126) before updating the software.

To update the software via Wi-Fi:

1. Connect to a Wi-Fi network (see page 139).
2. Display the general setting screen by pressing the “Home” button, then select “Settings”, and finally “General”.
3. Select “Software Update”, select “Update”, and then select “Check for Updates”
 - If “Automatically Check for Updates” is enabled, an update check will be performed automatically before proceeding to the next step.
 - If “Automatically Download Updates” is enabled, available software updates will be downloaded automatically.
4. Select “Download Now” to begin the download. The download status progress is displayed in the upper right of the screen. If you need to stop the download and restart at a later time, select “Cancel” to stop the process.
5. Select “Install Now” to start the installation process. The installation process will take several minutes to complete.
6. When the installation is complete, select “OK” on the confirmation message to complete the update process.
7. Turn the ignition to the “LOCK”/“OFF” position and open and close the driver’s door. After about 5 minutes, restart the engine, and the software installation will be applied.

INDEX

2.4L TURBO ENGINE	59
2.5L ENGINE	58

A

ACCESSORY CONNECTIONS	34
ADDING SHORTCUTS	74
ADVANCED ADAPTIVE CRUISE CONTROL	36
ANDROID AUTO™	136
Cables	136
Compatible Models	137
Connecting an Android Phone	136
APPLE CARPLAY®	137
Cables	137
Compatible Models	138
Connecting an iPhone	138
AUDIO CONTROLS	35
AUTO START-STOP	44

B

BLIND-SPOT DETECTION (BSD)/ REAR CROSS-TRAFFIC ALERT (RCTA)	112
Blind-Spot Detection (BSD)	112
Lane Change Assist (LCA)	112
Rear Cross-Traffic Alert (RCTA)	113
BLUETOOTH® PAIRING	130
Pairing an Android Device	130
Pairing an iOS/Apple Device	133
BUTTONS	67
Controlling the Volume	67

C

CARGO COVER	55
CENTER CONSOLE STORAGE	25
CHILD SAFETY LOCKS	52
CLIMATE CONTROL	26
11.6-Inch Automatic Climate Control	27
Dual 7-Inch Automatic Climate Control	26

Heated Seats	32
Heated Steering Wheel	33
Rear Heated Seats	33
Remote Engine Start with Climate Control	33
Ventilated Seats	32
CLOCK	99
COMBINATION METER	41
CREATING A DRIVER PROFILE	76

D

DRIVERFOCUS® COMPONENTS	115
Camera	115
Center Information Display (CID)	115
Combination Meter Display (CMD)	116
DRIVERFOCUS® OVERVIEW	115
DRIVER MONITORING SYSTEM OFF	119
DRIVER PROFILE/CONVENIENCE SETTINGS	117
Deleting a Driver	118
Recognizing a Driver	118
Registering a Driver	117
DRIVING THE VEHICLE	43
Automatic Transmission Shift Mode	43
Paddle Shift Control Switches	43
DROWSY/INATTENTIVE WARNINGS	117

E

ELECTRONIC PARKING BRAKE (EPB)	46
Auto Vehicle Hold (AVH)	47
ENGINE OIL	60
ENGINE OIL CAPACITY	60
ENROLLMENT	93
EYESIGHT® DISCLAIMER	122
EYESIGHT® OVERVIEW	100
EYESIGHT® ASSIST MONITOR (EAM)	109

F

FIRMWARE AND SOFTWARE	
UPDATES	161
FOLDING THE REAR SEATS	51
FRONT VIEW MONITOR	112
FUEL	50
FUEL CAPACITY	50
FUEL FILLER LID	50
FUNCTIONS	101
Advanced Adaptive Cruise Control with Lane Centering	104
Conventional Cruise Control	106
Lane Departure Prevention	104
Lane Departure Warning	103
Lane Sway Warning	103
Lead Vehicle Start Alert	107
Pre-Collision Brake Assist	102
Pre-Collision Braking	102
Pre-Collision Throttle Management	102

H

HIGH BEAM ASSIST (HBA)	113
HOME SCREEN ICONS	72
HOOD PROP	57
HOW TO CREATE A PROFILE	76
Retrieving a Driver Profile	79
HOW TO OVERVIEW	123

I

IGNITION SWITCH	42
IMPORTANT SAFETY INFORMATION	4
IN CASE OF EMERGENCY	6
Subaru Roadside Assistance	6
SUBARU STARLINK® Safety and Security	6
INSTRUMENT PANEL SWITCHES (LOWER LEFT)	35
I SWITCH	36

K

KEYLESS ACCESS WITH PUSH BUTTON START	10
Locking Using Door Handles	10
Locking Using the Rear Gate	11
Unlocking Using Door Handles	10
Unlocking Using the Rear Gate	11
KEYLESS ENTRY	8
Automatic Door Locking/Unlocking	9

L

LANE DEPARTURE WARNING AND PRE-COLLISION BRAKING SYSTEM	
OFF	110
Lane Departure Warning OFF	110
Pre-Collision Braking OFF	110
LATCH/ANCHOR	53
LIGHT CONTROLS	37
Daytime Running Lights	38
Illumination Brightness	37

M

MAKING A CALL	84
MAPS	142
Arrival Distance/Time	159
Canceling Guidance	159
Creating Home/Work	142
Finding a Destination By Address	146
Finding a Destination By POI	149
Guidance Screen Icons	157
Map Updates	160
Map View/Perspectives	158
Map Zoom	157
Nearest Gas Station	159
Route Options	152
Saving Destination as a Favorite	154
Shortest/Fastest/Economic	153
Traffic Information	158
MAPS/NAVIGATION	98
Checking for Map Updates	98

INDEX

Updating Maps Using Your PC/MAC . . .	99
Updating Over-the-Air	98
MAPS OVERVIEW	91
MEDIA	82
Aux Input	82
Bluetooth®	82
CD	82
USB / iPod	82
MEMORY DRIVER'S SEAT	129
MEMORY HEIGHT	128
MYSUBARU	90
Service Appointment Scheduler . . .	90
MYSUBARU INTEGRATION	94

N

NEW VEHICLE BREAK-IN	60
--------------------------------	----

O

OPERATION	101
OVERHEAD CONSOLE	40
OVERVIEW OF YOUR MULTIMEDIA SYSTEM	65
Screen Layout	66
Various Systems	65
OWNER'S RESOURCES	5

P

PAIRING A PHONE	83
PHONE	97
POWER EXTERIOR MIRRORS	21
Power Folding Mirrors	22
Reverse Tilt Mirror	23
POWER MOONROOF	25
Opening/Closing the Moonroof	25
Tilting the Moonroof	25
POWER REAR GATE (PRG)	12
From the Rear of the Vehicle	13
Hands-free Power Rear Gate	14
Power Rear Gate Button	12
Power Rear Gate Lock	14

POWER WINDOWS	24
PUSH-BUTTON IGNITION SWITCH . . .	42

R

RADIO	80
AM/FM Radio	80
Satellite Radio	81
Setting Presets	81
REARRANGING ICONS	73
REAR SEAT REMINDER	54
Passenger Occupant Detection and Seatbelt Reminders	54
REAR VIEW MIRROR	23
Auto-dimming Mirror	23
HomeLink® 5 Accessory Mirror . . .	24
REAR-VISION CAMERA	111
Rear-vision Camera Washer	111
REAR WINDOW WIPER	39
Rear-vision Camera Washer	39
RECEIVING A CALL	85
REVERSE AUTOMATIC BRAKING (RAB)	114
ROOF RAIL CAPACITY	61

S

SAFETY AND SECURITY OVERVIEW . . .	92
SEATING	18
Head Restraint Adjustment	20
Manual Seats	18
Power Driver's Seat (if equipped) . . .	19
Seatbelt Adjuster	20
SETTINGS AND UPDATES OVERVIEW . . .	95
Connect to Home Wi-Fi	95
Performing Software Updates	95
SETTING THE CLOCK	123
Automatically	126
Manually	124
SOUND	96
SPARE TIRE	56
STARTING THE VEHICLE	42
Without Push-button Ignition	42

With Push-button Ignition	42
STEERING RESPONSIVE HEADLIGHTS (SRH)	114
STEERING WHEEL CONTROLS	69
Advanced Adaptive Cruise Control . . .	107
Customizing EyeSight® Settings . . .	108
STEREO CAMERA PRECAUTIONS	120
SUBARU STARLINK® IN-VEHICLE	
APPS	87
Android™ Auto	87
Apple CarPlay®	87
SiriusXM® Travel Link	88
SUBARU STARLINK® MOBILE APP 88	
Chimani	89
eBird	89
Quick Reference Guide	89
SUBARU STARLINK® WI-FI HOTSPOT	94

T

TEXT MESSAGES	86
TILT AND TELESCOPIC STEERING	
COLUMN	21
TIRE PRESSURE MONITORING SYSTEM	
(TPMS)	62
TOUCHSCREEN	68
TOWING YOUR ALL-WHEEL DRIVE	
SUBARU	7
TRAILER TOWING CAPACITY	61
TURNING OFF THE VEHICLE 49	
Without Push-button Ignition	49
With Push-button Ignition	49
TURN SIGNALS	38

V

VOICE RECOGNITION	70
Common Commands	71
Tips	70

W

WARNING AND INDICATOR LIGHTS	41
WELCOME	4
WI-FI 139	
Connecting to a Wi-Fi Network	139
Wi-Fi Hotspot Subscription	140
WINDSHIELD GLASS AND	
DASHBOARD	120
WINDSHIELD WIPERS	38

X

X-MODE®	48
Hill Descent Control (HDC)	49

Subaru of America, Inc.
One Subaru Drive
Camden, NJ 08103-9800



MSA5B2104A
Issued November 2020
Printed in USA 11/20

