

Getting Started Guide

Forester

2021



Love. It's what makes Subaru, Subaru.



© 2020 Subaru of America, Inc. Printed in USA. All rights reserved. Contents may not be reproduced in whole or in part without prior written permission of publisher. Specifications in this Guide are based on the latest product information available at the time of publication. Some images shown are for illustration purposes only. Some equipment shown in photography within this Guide is optional at extra cost. Specific options may be available only in combination with other options. Specific combinations of equipment or features may vary from time to time, and by geographic area. Subaru of America, Inc. reserves the right to change or discontinue at any time, without notice: Prices, colors, materials, equipment, accessories, specifications, models and packages, without incurring any obligation to make the same or similar changes on vehicles previously sold. Colors shown may vary due to reproduction and printing processes. Subaru of America, Inc. is not responsible for typographical errors. Aha™ is a trademark of Harman International Industries, Incorporated. Alcantara® is a registered trademark of Alcantara S.p.A., and Alcantara is produced by the Toray Group. App Store® is a registered trademark of Apple, Inc. Apple® is a registered trademark of Apple, Inc. Apple CarPlay® is a registered trademark of Apple, Inc. Android Auto™ is a trademark of Google, LLC. BBS® is a registered trademark of BBS Kraftfahrzeugtechnik, AG. Bluetooth® is a registered trademark of Bluetooth SIG, Inc. Brembo® is a registered trademark of Freni Brembo, S.p.A. GreenEdge® is a registered trademark of Harman International Industries, Incorporated. Glympse® is a registered trademark of Glympse, Inc. Grand Luxe® is a registered trademark of Seiren Co., Ltd. HARMAN® is a registered trademark of HARMAN International Industries, Incorporated. Harman Kardon® is a registered trademark of Harman International Industries, Incorporated. Quantum logic™ is a trademark of Harman International Industries, Incorporated. HD Radio® is a registered trademark of iBiquity Digital Corporation. HomeLink® and the HomeLink® house icon are registered trademarks of Gentex Corporation. iHeartRadio® is a registered trademark of iHeartMedia, Inc. iPod® is a registered trademark of Apple, Inc. iTunes® is a registered trademark of Apple, Inc. Magellan® is a registered trademark of MiTAC International Corporation. Michelin® is a registered trademark of Compagnie Générale des Etablissements Michelin. Metal-Matrix Diaphragm (MMD®) is a registered trademark of Harman International Industries, Incorporated. MirrorLink™ is a trademark of Car Connectivity Consortium, LLC. Pandora® is a registered trademark of Pandora Media, Inc. SACHS® is a registered trademark of ZF Friedrichshafen AG. Siri® is a registered trademark of Apple, Inc. Smart Way® is a registered trademark of the U.S. Environmental Protection Agency. Stitcher™ is a trademark of Stitcher™, Inc. TomTom® is a registered trademark of TomTom International BV. TORSEN LSD® is a registered trademark of JTEKT TORSEN North America, Inc. SiriusXM® All Access Radio is a registered trademark of Sirius XM Radio, Inc. SiriusXM Traffic® is a registered trademark of Sirius XM Radio, Inc. SiriusXM Travel Link® is a registered trademark of SiriusXM Radio, Inc. Ultrasuede® is a registered trademark of Toray Industries, Inc. Yelp® is a registered trademark of Yelp, Inc. Ascent, DriverFocus, and StarDrive, are trademarks of Subaru of America, Inc. Added Security, Crosstrek, Forester, Outback, StarTex and XV Crosstrek are registered trademarks of Subaru of America, Inc. BRZ, Confidence in Motion, EyeSight, Impreza, Lineartronic, Legacy, S209, Subaru, SUBARU STARLINK®, SUBARU BOXER, tS (Design), WRX, STI and X-MODE are registered trademarks of Subaru Corporation.

TABLE OF CONTENTS



PURPOSE OF THIS GUIDE

| | |
|---|---|
| WELCOME | 4 |
| IMPORTANT SAFETY INFORMATION | 4 |
| OWNER'S RESOURCES | 4 |
| IN CASE OF EMERGENCY | 5 |
| TOWING YOUR ALL-WHEEL DRIVE SUBARU | 6 |

ENTRY AND EXIT

| | |
|--|----|
| KEYLESS ENTRY | 7 |
| KEYLESS ACCESS WITH PUSH BUTTON START | 9 |
| POWER REAR GATE (PRG) | 11 |

INSTRUMENT PANEL

GETTING COMFORTABLE

| | |
|--|----|
| SEATING | 16 |
| TILT AND TELESCOPIC STEERING COLUMN | 18 |
| POWER EXTERIOR MIRRORS .. | 18 |
| REAR VIEW MIRROR | 19 |
| POWER WINDOWS | 20 |
| POWER MOONROOF | 20 |
| CLIMATE CONTROL | 21 |
| ACCESSORY CONNECTIONS .. | 27 |

CONTROLS

| | |
|---|----|
| INSTRUMENT PANEL SWITCHES (LOWER LEFT) | 28 |
| AUDIO CONTROLS | 28 |
| ADVANCED ADAPTIVE CRUISE CONTROL | 29 |
| I/SET SWITCH | 29 |
| INFO SWITCH | 30 |
| LIGHT CONTROLS | 30 |
| TURN SIGNALS | 31 |
| WINDSHIELD WIPERS | 32 |
| REAR WINDOW WIPER | 32 |
| OVERHEAD CONSOLE | 33 |

GAUGES AND WARNING

LIGHTS

| | |
|---------------------------------------|----|
| COMBINATION METER | 34 |
| WARNING AND INDICATOR LIGHTS | 34 |

OPERATING THE VEHICLE

| | |
|--------------------------------------|----|
| IGNITION SWITCH | 35 |
| PUSH-BUTTON IGNITION SWITCH | 35 |
| STARTING THE VEHICLE | 35 |
| DRIVING THE VEHICLE | 36 |

TABLE OF CONTENTS

| | | | |
|--|----|--|----|
| AUTO START-STOP | 38 | PHONE | |
| ELECTRONIC PARKING BRAKE (EPB) | 40 | PAIRING A PHONE | 66 |
| X-MODE® | 41 | MAKING A CALL | 66 |
| TURNING OFF THE VEHICLE | 43 | RECEIVING A CALL | 67 |
| REFUELING | | TEXT MESSAGES | 68 |
| FUEL FILLER LID | 44 | APPS | |
| FUEL | 44 | SUBARU STARLINK® IN-VEHICLE APPS | 69 |
| FUEL CAPACITY | 44 | SUBARU STARLINK® MOBILE APP | 71 |
| PASSENGER/CARGO AREAS | | MYSUBARU | 73 |
| FOLDING THE REAR SEATS | 45 | MAPS (if equipped) | |
| CHILD SAFETY LOCKS | 45 | MAPS OVERVIEW | 74 |
| LATCH/ANCHOR | 46 | CREATING HOME AND WORK PROFILES | 74 |
| REAR SEAT REMINDER | 47 | STARLINK SAFETY AND SECURITY | |
| CARGO COVER | 48 | SAFETY AND SECURITY OVERVIEW | 75 |
| SPARE TIRE AND JACK | 48 | ENROLLMENT | 76 |
| ENGINE COMPARTMENT | | MYSUBARU INTEGRATION | 77 |
| HOOD PROP. | 49 | SUBARU STARLINK® WI-FI HOTSPOT | 77 |
| 2.5 L ENGINE | 50 | SETTINGS AND UPDATES | |
| ADDITIONAL SPECIFICATIONS | | SETTINGS AND UPDATES OVERVIEW | 78 |
| NEW VEHICLE BREAK-IN | 51 | SOUND | 79 |
| ENGINE OIL | 51 | PHONE | 79 |
| ENGINE OIL CAPACITY | 51 | MAPS/NAVIGATION | 80 |
| ROOF RAIL CAPACITY | 52 | CLOCK | 82 |
| TRAILER TOWING CAPACITY | 52 | EYESIGHT | |
| TIRE PRESSURE MONITORING SYSTEM (TPMS) | 53 | EYESIGHT® OVERVIEW | 84 |
| STARLINK OVERVIEW | | OPERATION | 84 |
| OVERVIEW OF YOUR MULTIMEDIA SYSTEM | 54 | FUNCTIONS | 85 |
| BUTTONS | 54 | STEERING WHEEL CONTROLS | 91 |
| TOUCHSCREEN | 56 | LANE DEPARTURE WARNING AND PRE-COLLISION BRAKING SYSTEM OFF SWITCHES | 92 |
| STEERING WHEEL CONTROLS | 57 | | |
| VOICE RECOGNITION | 57 | | |
| STARLINK HOME | | | |
| HOME SCREEN ICONS | 60 | | |
| REARRANGING ICONS | 60 | | |
| ADDING SHORTCUTS | 61 | | |
| DRIVER PROFILE | | | |
| CREATING A DRIVER PROFILE | 62 | | |
| MULTIMEDIA | | | |
| RADIO | 64 | | |
| MEDIA | 65 | | |

TABLE OF CONTENTS

DRIVER ASSIST TECHNOLOGIES

| | |
|---|----|
| REAR-VISION CAMERA | 93 |
| BLIND-SPOT DETECTION (BSD)/ REAR CROSS-TRAFFIC ALERT (RCTA) | 93 |
| HIGH BEAM ASSIST (HBA) | 94 |
| STEERING RESPONSIVE HEADLIGHTS (SRH) | 94 |
| REVERSE AUTOMATIC BRAKING (RAB) | 95 |

DRIVERFOCUS DISTRACTION MITIGATION SYSTEM

| | |
|--|-----|
| DRIVERFOCUS® OVERVIEW | 96 |
| DRIVERFOCUS® COMPONENTS | 96 |
| DROWSY/INATTENTIVE WARNINGS | 99 |
| DRIVER PROFILE/CONVENIENCE SETTINGS | 99 |
| DRIVER MONITORING SYSTEM OFF | 100 |

CARE AND LIMITATIONS

| | |
|---|-----|
| STEREO CAMERA PRECAUTIONS | 101 |
| WINDSHIELD GLASS AND DASHBOARD | 101 |

FRONT VIEW

| | |
|--------------------|-----|
| FORESTER | 102 |
|--------------------|-----|

EYESIGHT DISCLAIMER

| | |
|--------------------------------|-----|
| EYESIGHT® DISCLAIMER | 103 |
|--------------------------------|-----|

HOW TO APPENDIX

| | |
|--|-----|
| HOW TO OVERVIEW | 104 |
| MEMORY HEIGHT | 105 |
| MEMORY DRIVER'S SEAT | 107 |
| BLUETOOTH® PAIRING | 108 |
| ANDROID AUTO™ | 116 |
| APPLE CARPLAY® | 118 |
| WI-FI | 120 |
| MAPS | 122 |
| FIRMWARE AND SOFTWARE UPDATES | 130 |

INDEX

PURPOSE OF THIS GUIDE

WELCOME

Congratulations on choosing a Subaru Forester and welcome to the Subaru family!

Subaru is more than a car company™. We are committed to making the world a better place, and the Subaru Love Promise is our vision to show love and respect to all people at every interaction with Subaru. We believe in building lifelong relationships with our customers, earning your trust and exceeding your expectations by providing customer service with integrity and compassion.

This Getting Started Guide will introduce you to your new Subaru Forester by providing information on the basic operation and key features of your Subaru as well as the STARLINK® and EyeSight® systems in your vehicle.

IMPORTANT SAFETY INFORMATION

The Getting Started Guide is not intended as a substitute for the Owner's Manuals. We strongly encourage you to review the vehicle, STARLINK®, and EyeSight® Owner's Manuals to ensure complete understanding.

OWNER'S RESOURCES

If you're having difficulty using any of the functions outlined in this guide, or to learn more, you can get more information from the following sources:

Your Subaru Owner's Manuals:

Located in the glovebox

Online Subaru Owner's Resources:

www.subaru.com/owners

Subaru Customer Support:

www.subaru.com/customer-support

1-800-782-2783 (1-800-SUBARU3)



Scan to learn more about **Owner's Resources**.



Scan to learn more about **Customer Support**.



Scan to get the **MySubaru** App.



Scan to get the **SUBARU STARLINK®** App.

PURPOSE OF THIS GUIDE

IN CASE OF EMERGENCY

SUBARU STARLINK® Safety and Security (subscription required)

SOS Emergency: Press the red “SOS” button on the overhead console in the event of an emergency to speak with a SUBARU STARLINK® Customer Care Advisor.

Enhanced Roadside Assistance: Press the blue “i” button on the overhead console or select the “Roadside Assistance” option in the “MySubaru” menu on the multimedia system.



SOS and Roadside Assistance Buttons

i For more information, please refer to “Safety and Security Overview” on page 75 or the SUBARU STARLINK® Safety and Security Owner’s Manual.

Subaru Roadside Assistance

Subaru Roadside Assistance:
1-800-261-2155

Subaru Roadside Assistance is free and standard on your Subaru; there are no forms to complete. This service is available anytime during the 3-year/36,000-mile Subaru Limited Warranty, whichever comes first. See your retailer for details and refer to the Roadside Assistance guide in the owner’s information kit for the details on this coverage. A Subaru Roadside Assistance decal has been affixed to the driver’s door window.

Roadside assistance helps with:

- Towing to the nearest authorized Subaru retailer if you cannot safely drive your Subaru
- Jump-start if your battery is dead
- Gasoline delivery if you run out of gas
- Flat tire change to install your spare
- Emergency lockout service
- National Subaru retailer locator service, with phone numbers and location of the nearest retailer anywhere in the U.S. or Canada

NOTE: Specifically excluded from Subaru Roadside Assistance coverage are service requests or claims resulting from: accidents, vandalism, acts of God, violation of any laws, or vehicle modifications not recommended by the manufacturer.

PURPOSE OF THIS GUIDE

TOWING YOUR ALL-WHEEL DRIVE SUBARU

Since Subaru Symmetrical All-Wheel Drive distributes power to all four wheels, improper towing may damage your AWD system. The best way to tow your Forester is with a flatbed truck by your Subaru retailer or a commercial towing service.

KEYLESS ENTRY

1 Lock/Arm

- Press the lock/arm button to lock the doors, the rear gate, and the fuel door and to activate the security alarm. A chirp sounds and the hazard warning lights flash once.
- If any of the doors or the rear gate are not fully closed, five rapid chirps sound and the hazard warning lights will flash to alert you.
- Press the lock/arm button three times to activate the vehicle finder function. If you are within 30 feet of your Subaru, the horn sounds once, and the hazard warning lights flash three times.

2 Unlock/Disarm

- Press the unlock/disarm button once to unlock the driver's door and fuel door. To unlock all the doors and the rear gate, briefly press the button twice. Two chirps sound and the hazard warning lights flash twice.
- The interior lights will illuminate when you press the unlock/disarm button if they are set to the "DOOR" position on the overhead console.

3 Rear Gate

- Press the rear gate button to unlock the rear gate.
- If your Subaru has a Power Rear Gate, press and hold this button to open or close the rear gate.

4 Panic Alarm

- Press the panic alarm button to sound the horn and flash the hazard warning lights.
- Press any button on the access key fob or transmitter to deactivate the panic alarm.



Transmitter



Access Key Fob

ENTRY AND EXIT

Automatic Door Locking/Unlocking

This feature allows you to set when your Subaru automatically locks or unlocks the doors through the STARLINK® Touchscreen (select “Settings” then “Vehicle”). The available settings are listed in the table below.

| | AVAILABLE SETTINGS | | | |
|-------------------------|------------------------------|------------------------------|-----------------------|-----|
| AUTO DOOR LOCK | Vehicle Speed (12 mph) | Shift into or out of PARK | OFF | |
| AUTO DOOR UNLOCK | Shift into or out of PARK | Ignition OFF | Driver's Door Open | OFF |

KEYLESS ACCESS WITH PUSH BUTTON START (if equipped)

The Keyless Access with Push-Button Start system features touch-activated door locking or unlocking and push-button start functions without the key ever leaving your pocket or purse. You can customize the touch-activated door locking or unlocking settings using the i/Set switch to navigate to “Vehicle Setting” then “Keyless Entry System” in the Combination Meter Display or through the STARLINK® Touchscreen by selecting “Settings” then “Vehicle”.

Unlocking Using Door Handles

Grip the driver’s door handle to unlock the driver’s door (or all doors depending on the setting). Grip the front passenger’s door handle to unlock all doors and the rear gate. Two chirps sound and the hazard warning lights flash twice.



Door Unlock Sensor

Locking Using Door Handles

Close all the doors and the rear gate and touch the door lock sensor (two lines) on either front door handle. All doors and the rear gate lock. One chirp sounds and the hazard warning lights flash once.



Door Lock Sensor

ENTRY AND EXIT

Unlocking Using the Rear Gate

Press the rear gate opener button to unlock and open the rear gate (or also unlock all doors depending on the setting). Two chirps sound and the hazard warning lights flash twice.



Rear Gate Opener Button

Locking Using the Rear Gate

Close all the doors and the rear gate and press the rear lock button. All doors and the rear gate lock. One chirp sounds and the hazard warning lights flash once.



Rear Lock Button

POWER REAR GATE (PRG) (if equipped)

The Power Rear Gate allows automatic opening even when your arms are full, and a single touch on the gate button lets it close and lock the entire vehicle. The opening height can also be adjusted for spaces where clearance is limited.

Power Rear Gate Button

Opening the Power Rear Gate

Press and hold the Power Rear Gate Button on the instrument panel to automatically open the rear gate. Two chirps sound and the hazard warning lights flash twice.

Stopping the Power Rear Gate

If you briefly press the Power Rear Gate Button while the rear gate is opening, it will stop. Press and briefly hold the button again to close the rear gate.



Power Rear Gate Button

Closing the Power Rear Gate

Press and hold the Power Rear Gate Button on the instrument panel to close the rear gate. If you briefly press the button while the rear gate is closing, it will open.

The operation is the same using the Power Rear Gate Button on the access key fob or transmitter.

NOTE: This button only functions to open the PRG when the doors are unlocked. If the doors are locked, you will hear three rapid beeps from the vehicle.

ENTRY AND EXIT

From the Rear of the Vehicle

Opening the Power Rear Gate

To open the rear gate, briefly press the Rear Gate Opener Button on the underside trim near the license plate, and the rear gate automatically opens.



Rear Gate Opener Button

Stopping the Power Rear Gate

If you briefly press the Power Rear Gate Close Button on the inside edge of the rear gate while the gate is opening, it will stop. Press the button again to close the rear gate.



Power Rear Gate Close Button

Closing the Power Rear Gate

To close the rear gate, briefly press the Power Rear Gate Close Button on the inside edge of the rear gate. If you press the button while the gate is closing, it will open.

Power Rear Gate Lock

Press the lock button on the inside edge of the rear gate. The Power Rear Gate will close, and all doors, the rear gate, and the fuel lid will lock.



Power Rear Gate Close and Lock Button

i The Power Rear Gate also comes equipped with a memory height function, allowing you to set where the Power Rear Gate stops when it opens. For step by step instructions on setting the memory height, please refer to page 105.

INSTRUMENT PANEL

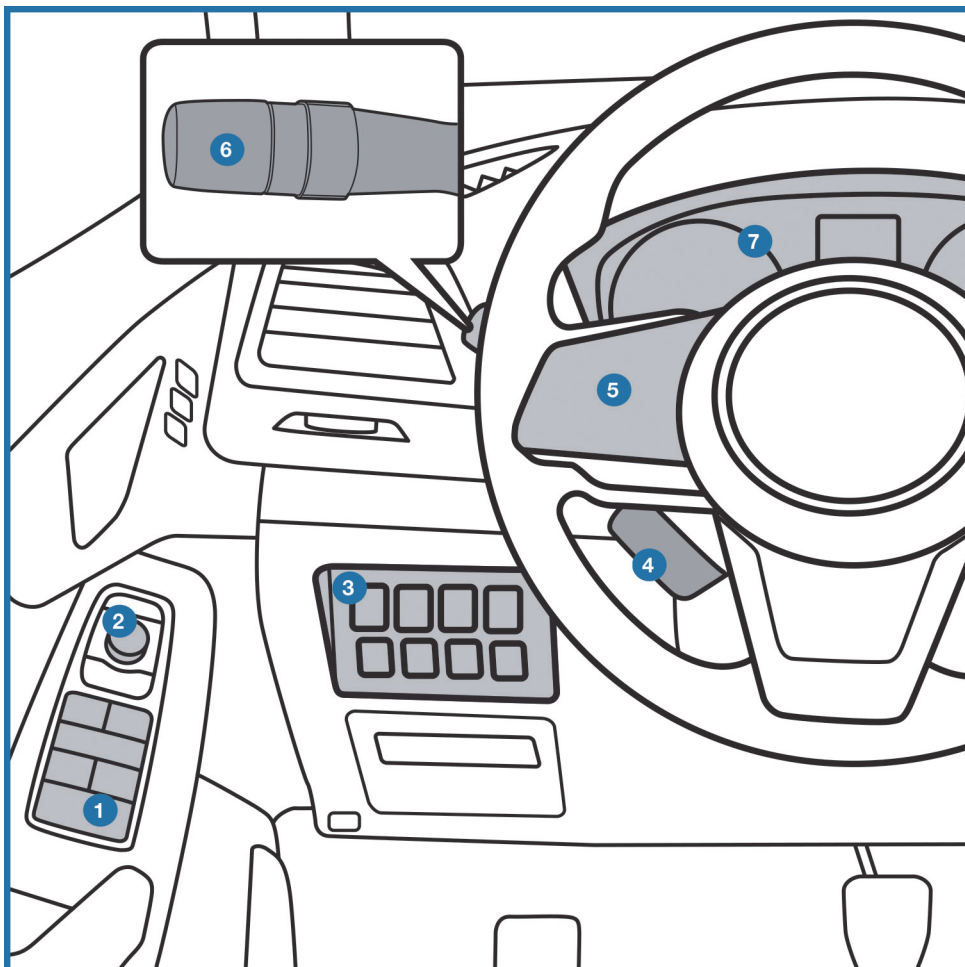

- ① Power Windows (p. 20)
- ② Power Exterior Mirrors (p. 18)
- ③ Instrument Panel Switches (p. 28)
- ④ I/Set Switch (p. 29)
- ⑤ Audio Controls (p. 28)
- ⑥ Light Controls (p. 30)
- ⑦ Combination Meter (p. 34)

INSTRUMENT PANEL

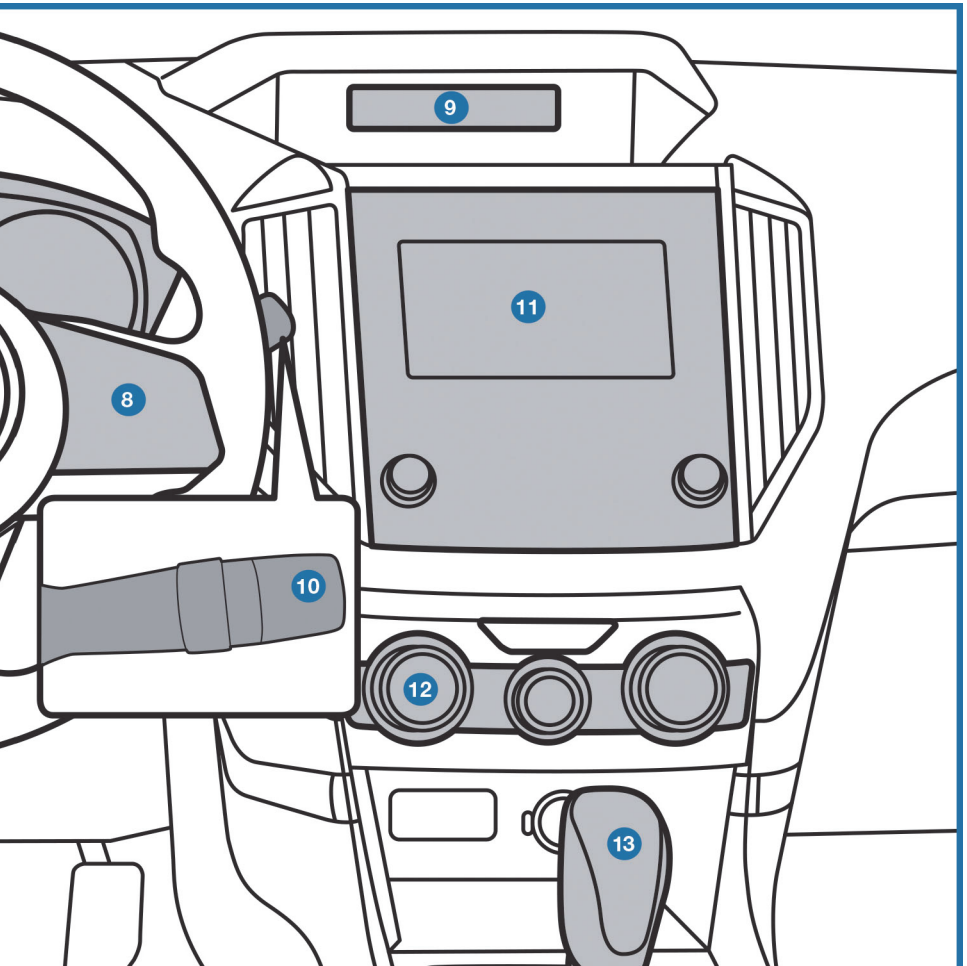

- ⑧ Advanced Adaptive Cruise Control (p. 29)
- ⑨ Multi-Function Display (MFD) (p. 30)
- ⑩ Windshield Wipers (p. 32)
- ⑪ STARLINK® Multimedia Touchscreen (p. 54)
- ⑫ Climate Control System (p. 21)
- ⑬ CVT Select Lever (p. 36)

GETTING COMFORTABLE

SEATING

Manual Seats

- 1 Forward/Backward:** Pull the lever below the seat up and slide the seat forward or backward. Release the lever and make sure the seat is locked into place.
- 2 Seat Height (Driver's Seat):** Pulling up or pushing down on the lever will raise or lower the seat cushion.
- 3 Recline Seatback:** Pull the lever up to adjust the seatback. Release the lever and make sure the seatback is locked into place.



Manual Seat Levers

Power Driver's Seat (if equipped)

- 1 Seat Position:** Moving the switch forward or backward will adjust the seat in that direction. Pulling up or pushing down on the back of the switch will adjust the seat height up or down. Pulling up or pushing down on the front of the switch will adjust the angle of the seat cushion.
- 2 Recline Seatback:** Moving the top of the switch forward or backward will adjust the angle of the seatback.
- 3 Lumbar Support:** Pressing the front of the switch will increase support. Pressing the rear of the switch will decrease support.



Power Seat Controls

GETTING COMFORTABLE

Head Restraint Adjustment

Pull the head restraint up to raise it to the first position. To raise it farther, press the release button on top of the seatback while raising the head restraint. To lower the head restraint, push it down while pressing the release button. Each head restraint should be adjusted so that the center of the head restraint is closest to the top of the occupant's ears.

The angle of the front head restraints can be adjusted by tilting them forward. You will hear a click when the restraint locks in place. Pulling the head restraint as far forward as it will go allows it to return to the fully upright position.

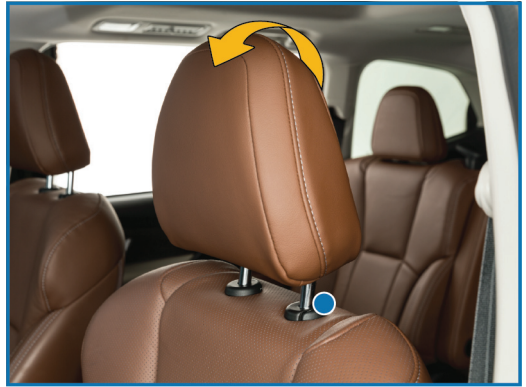

Release Button and Head Restraint Adjustment

Seatbelt Adjuster

To keep yourself comfortable and safe, always position the seatbelt adjuster so the shoulder belt passes over the middle of your shoulder without touching your neck. Pull the tab out and slide the adjuster up or down to set the position. Release the tab and make sure the adjuster is locked in place.



Seatbelt Adjustment Tab

GETTING COMFORTABLE

TILT AND TELESCOPIC STEERING COLUMN

You can adjust both the height and lengthwise position of the steering wheel. Pull the lever on the side of the steering column down firmly to unlock, then adjust the position of the steering wheel. Push the lever firmly back up to lock the steering column in place.



Steering Column Unlock

POWER EXTERIOR MIRRORS

Turn the knob to “L” (left side) or “R” (right side) to select a mirror. Push the knob in the direction you want to move the mirror. Turn the knob back to the center position when finished.



Power Mirror Knob

Auto Tilt-down Mirror (if equipped)

The passenger side mirror will automatically tilt down when you move the select lever to the "R" position, giving better visibility when backing up. The mirror returns to its normal position a few seconds after you move the select lever out of the "R" position. You can turn the tilt-down mirror off or on in the Combination Meter Display (CMD).

REAR VIEW MIRROR

Auto-dimming Mirror (if equipped)

The auto-dimming function senses distracting glare during nighttime driving and automatically dims to eliminate the glare and preserve your vision. Press the switch to turn auto-dimming on or off. A green LED indicator on the switch illuminates when the function is on.



HomeLink® 5 Accessory Mirror (if equipped)

The HomeLink® 5 accessory mirror provides three buttons to replace devices such as garage door openers, gate openers, entry door locks, security systems, and home lighting. The Owner's Manual provides programming instructions, and www.subaru.com/homelink has a helpful "how to" video.



NOTE: HomeLink® 5 may not be compatible with some older door openers or additional equipment may be required.



Scan to learn more about HomeLink®.

GETTING COMFORTABLE

POWER WINDOWS

To open or close a window, partially press down or pull up and hold the corresponding switch. The driver's window has a one-touch auto up/down function, and the front passenger's window may also have an auto up/down function, if equipped. Fully press down or pull up and release to automatically open or close a one-touch window.



Power Window Switches

POWER MOONROOF (if equipped)

The moonroof operates with the ignition in the "ON" position.

1 Opening: Press, briefly hold, and release the switch to automatically open the moonroof. This also automatically opens the sunshade if it is closed.

The moonroof will stop slightly before the fully-open position to reduce wind noise. Press, briefly hold, and release the switch again to fully open it.

2 Closing: Press, briefly hold, and release the switch to close the moonroof. This also automatically closes the sunshade.

To stop the moonroof partway while opening or closing, press either side of the switch.



CLIMATE CONTROL

Automatic Climate Control



Set your desired temperature and let the system automatically make the adjustments for you. At any time, you can manually take control of the climate settings.

Operation in Automatic Mode

- 1 Automatic Control Button:** This system automatically controls all of the climate system except defogging. Press “AUTO” to activate. Press “OFF” to turn off the system.
- 2 Temperature Control Dial:** Turn the dial clockwise to increase the temperature or counterclockwise to decrease the temperature. The temperature will appear on the Multi-Function Display (MFD).

When using automatic mode, the fan speed, airflow distribution, air-inlet control and air conditioning compressor are controlled automatically. To activate:

1. Press the “AUTO” button. The “FULL AUTO” indicator light illuminates on the Multi-Function Display (MDF).
2. Set the preferred temperature using the temperature control dial.







If you operate any of the buttons other than “ON/OFF”, rear window defogger, or the temperature control dial, the “FULL” indicator light will turn off. The “AUTO” light will remain illuminated. You can then manually control the system as desired. Press the “AUTO” button to change back to “FULL AUTO” mode.

Operation in Manual Mode

- 3 Air Conditioner Button:** Press this button to activate or deactivate the air conditioning.

GETTING COMFORTABLE

- 4 MAX A/C Button:** Press this button for quickest cooling.
- 5 Airflow Mode Selection Dial:** Turn the dial to select the desired airflow mode. The selected mode – ventilation, ventilation 2, bi-level, feet, or feet-defrost – is shown on the display.

| ICON | MODE | FUNCTION |
|--|---------------|---|
|  | Ventilation | Instrument panel outlets |
|  | Ventilation 2 | Instrument panel outlets and less foot outlets than bi-level |
|  | Bi-Level | Instrument panel outlets and foot outlets |
|  | Feet | Foot outlets, both side outlets of the instrument panel and some through windshield defroster outlets |
|  | Feet-Defrost | Windshield defroster outlets, foot outlets and both side outlets of the instrument panel |
|  | Defrost | Windshield defroster outlets and both side outlets of the instrument panel |

NOTE: The defroster button is used to activate the defrost airflow mode.

- 6 Fan Speed Control Dial:** Turn the fan speed control dial to increase or decrease fan speed.
- 7 Recirculated/Outside Air Button:** Press this button to prevent outside air from entering your Subaru. Press the button again to allow outside air into your Subaru.
NOTE: To prevent windshield fogging, do not remain in the recirculated mode for an extended period of time.
- 8 Defroster Button:** Press this button to defrost or dehumidify the windshield and front door windows.
NOTE: The air conditioning may turn on to defrost the windshield more quickly. However, the indicator on the air conditioner button will not illuminate.

GETTING COMFORTABLE

- 9 Rear Window Defogger Button:** Press this button to turn on the rear window defogger. It will automatically turn off after about 15 minutes. If the window clears before then, press the button again to turn it off. If equipped, the outside mirror defogger and windshield wiper deicer will also activate. You can customize this function for continuous operation through the Combination Meter Display (CMD) or the STARLINK® Touchscreen by selecting “Settings” then “Vehicle”.

Dual–Zone Automatic Climate Control (if equipped)

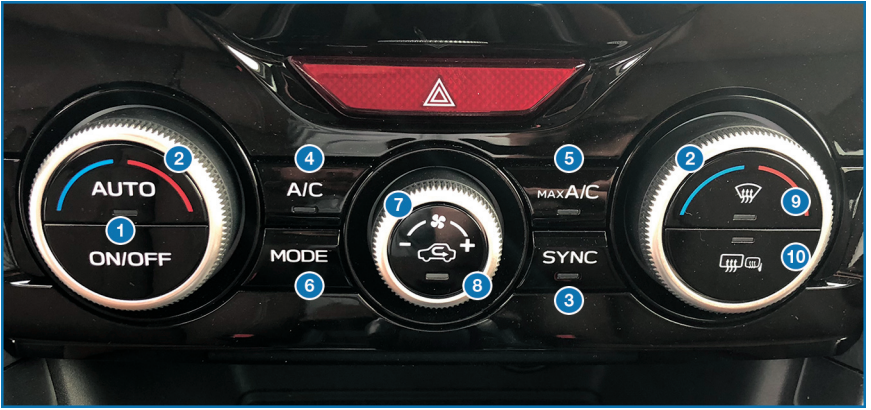

You can set separate temperatures for the driver and front passenger. Set your desired temperature and let the system automatically make the adjustments for you. At any time, you can manually take control of the climate settings.

Operation in Automatic Mode

- 1 Automatic Control Button:** This system automatically controls all of the climate system except defogging. Press “AUTO” to activate. Press “OFF” to turn off the system.
- 2 Temperature Control Dial:** Turn the dial clockwise to increase the temperature or counterclockwise to decrease the temperature. The temperature will appear on the screen. You can adjust separate temperature settings for the driver’s side and passenger’s side.
- 3 SYNC Button:** Press the button to synchronize the driver’s and front passenger’s temperatures to the driver’s temperature control dial.

When using automatic mode, the fan speed, airflow distribution, air-inlet control and air conditioning compressor are controlled automatically. To activate:







1. Press the “AUTO” button. The “FULL AUTO” indicator light illuminates on the Multi-Function Display (MDF).

GETTING COMFORTABLE

2. Set the preferred temperature using the temperature control dial.

If you operate any of the buttons other than “ON/OFF”, rear window defogger, “SYNC”, or the temperature control dial, the “FULL” indicator light will turn off. The “AUTO” light will remain illuminated. You can then manually control the system as desired. Press the “AUTO” button to change back to “FULL AUTO” mode.

- 4 Air Conditioner Button:** Press this button to activate or deactivate the air conditioning.
- 5 MAX A/C Button:** Press this button for quickest cooling.
- 6 Airflow Mode Selection Button:** Press the button to select the desired airflow mode. The selected mode – ventilation, ventilation 2, bi-level, feet, feet-defrost or defrost – is shown on the display.

| ICON | MODE | FUNCTION |
|--|---------------|---|
|  | Ventilation | Instrument panel outlets |
|  | Ventilation 2 | Instrument panel outlets and less foot outlets than bi-level |
|  | Bi-Level | Instrument panel outlets and foot outlets |
|  | Feet | Foot outlets, both side outlets of the instrument panel and some through windshield defroster outlets |
|  | Feet-Defrost | Windshield defroster outlets, foot outlets and both side outlets of the instrument panel |
|  | Defrost | Windshield defroster outlets and both side outlets of the instrument panel |

NOTE: The defroster button is used to activate the defrost airflow mode.

- 7 Fan Speed Control Dial:** Turn the fan speed control dial to increase or decrease fan speed.

GETTING COMFORTABLE

- 8 Recirculated/Outside Air Button:** Press this button to prevent outside air from entering your Subaru. Press the button again to allow outside air into your Subaru.
NOTE: To prevent windshield fogging, do not remain in the recirculated mode for an extended period of time.
- 9 Defroster Button:** Press this button to defrost or dehumidify the windshield and front door windows.
NOTE: The air conditioning may turn on to defrost the windshield more quickly. However, the indicator on the air conditioner button will not illuminate.
- 10 Rear Window Defogger Button:** Press this button to turn on the defogger. It will automatically turn off after about 15 minutes. If the window clears before then, press the button again to turn it off. If equipped, the outside mirror defogger and windshield wiper deicer will also activate. You can customize this function for continuous operation through the Combination Meter Display (CMD) or the SUBARU STARLINK® Touchscreen by selecting “Settings” and “Vehicle”.

Heated Seats (if equipped)

The heated seat switches are located between the driver and passenger seats. There is a separate switch for the driver and passenger. Press the “HI” button for more rapid heating or press the “LO” button for normal heating. Return the switch to the center position to turn off the heated seat.



Heated Seat Switches

GETTING COMFORTABLE

Rear Heated Seats (if equipped)

There are separate heated seat switches for each side on the rear center console. Press the switch to activate the heated seat. The heating mode changes to High, Low, and Off each time you press the switch, and yellow indicators illuminate indicating the level.



Heated Steering Wheel (if equipped)

To activate, pull the heated steering wheel switch with the ignition in “ON” or “ACC”. The indicator light on the switch will illuminate. To deactivate, pull the switch again. The heater will stay on for approximately 30 minutes.



Remote Engine Start with Climate Control



This feature can also be set through **MySubaru.com** or the **MySubaru App**



MySubaru App



MySubaru.com

You can remotely start your Subaru and adjust the temperature using the STARLINK® Safety and Security features through the **MySubaru App** (subscription required). Please refer to your SUBARU STARLINK® Owner's Manual for a list of required vehicle conditions for this feature.

ACCESSORY CONNECTIONS

1 Auxiliary Input Jack:

The 3.5mm auxiliary input jack is located below the climate control dials. You can connect a portable music player to the auxiliary jack and hear the music stored on it through your multimedia system. Press the “Source” button located on the steering wheel or the “Media” button on the Touchscreen to select the auxiliary mode.

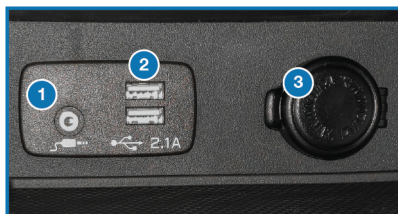

Connection Ports

For more information, please refer to page 65 or your SUBARU STARLINK® Owner's Manual.

2 Dual USB Ports:

The USB ports are located below the climate control dials and, if equipped, on the center console in the rear seat area. You can connect a variety of USB-equipped devices to the front ports, such as portable music players or smartphones, to enjoy your favorite music through your multimedia system. All ports provide charging (5V, 2.1A) to devices. The ports on the rear center console are for charging only.

For more information, please refer to page 65 or your SUBARU STARLINK® Owner's Manual.

3 Power Outlets:

Power outlets (12V) are located below the climate control dials, in the center console, and in the cargo area behind the rear seats. Electrical power is available for use with in-vehicle electrical appliances with a maximum power rating of 120W. These outlets cannot be used to connect to the SUBARU STARLINK® Multimedia System.

For more information, please refer to your Owner's Manual.

CONTROLS

INSTRUMENT PANEL SWITCHES (LOWER LEFT)

The switches in the lower left of the instrument panel allow you to control several convenient and important features. Knowing their location and function will improve your driving experience.

- 1 Power Rear Gate (if equipped, p. 11)
 - 2 Steering Responsive Headlights OFF (p. 94)
 - 3 Power Rear Gate Memory Height (if equipped, p. 105)
 - 4 Illumination Brightness (p. 31)
 - 5 Vehicle Dynamics Control OFF (if equipped, p. 42)
 - 6 Auto Start-Stop OFF (p. 38)
 - 7 Blind Spot Detection/Rear Cross Traffic Alert OFF (if equipped, p. 94)
 - 8 Driver Monitoring System OFF (if equipped, p. 100)
- 1 For more information, please refer to your EyeSight® and vehicle Owner's Manuals.



AUDIO CONTROLS

- 1 Presets/Skip
 - 2 Volume
 - 3 Source
 - 4 INFO
 - 5 Call/Voice Recognition
- 1 For more information about your audio system and controls, please refer to page 57 or the SUBARU STARLINK® Owner's Manual.



ADVANCED ADAPTIVE CRUISE CONTROL

- 1 Adaptive Cruise Control On/Off
- 2 Lane Keep Assist
- 3 Increase Distance
- 4 Decrease Distance
- 5 Resume (RES)/Increase Speed and Set (SET)/Decrease Speed
- 6 SI-Drive

1 For more information on SI-Drive, please refer to page 37 or your Owner's Manual.

1 For more information on Advanced Adaptive Cruise Control, please refer to page 91 or the EyeSight® Owner's Manual.



I/SET SWITCH

The "i/Set" switch allows you to cycle through useful driving information in the Combination Meter Display such as fuel consumption, driving time, speed, and tire pressure. You can change the information displayed using the up and down arrows.

When the Menu Entering Screen is displayed, pull and hold the "i/Set" switch to enter the Menu Screen for the ability to modify a number of vehicle settings.

1 For more information, please refer to "Combination Meter Display" in your Subaru Owner's Manual.



CONTROLS

INFO SWITCH

Press the INFO switch to cycle through useful information in the Multi-Function Display (MFD). Navigate to the guidance screen and hold the INFO switch to access the settings menu and adjust a number of MFD settings.

 For more information, please refer to page 97 or “Multi-Function Display” in your Subaru Owner’s Manual.



LIGHT CONTROLS

1 AUTO: Rotate the end of the lever to set your headlights to automatically turn on or off, depending on the level of light outside.

NOTE: The sensitivity of the automatic headlights can be adjusted through the STARLINK® multimedia display.

2 Parking Lights: Rotate the end of the lever to turn on the instrument panel lights, parking lights, side marker lights, tail lights, and license plate lights.

3 Headlights: Rotate the end of the lever to turn on the headlights, instrument panel lights, parking lights, side marker lights, tail lights, and license plate lights.

4 High Beams: Push the lever forward to change from low beam to high beam. When set to the “AUTO” position, pushing the lever forward also activates the High Beam Assist (HBA) system. Pull the lever back to center to return to low beam.

5 Fog Lights: If equipped, rotate the dial to turn on the fog lights when the headlights are on low beams in the  or “AUTO” position.



Illumination Brightness

When the light controls are on (in the DRL , OFF , or “AUTO” position), and ambient light is low, rotating the illumination brightness dial on the instrument panel upward will make the instrument panel illumination brighter. When the dial is fully rotated upward (dots aligned), the instrument panel illumination stays at full brightness. Rotating the dial downward dims the instrument panel illumination.



Illumination Brightness Dial

When the ambient light is bright, the illumination brightness is set to the maximum regardless of the position of the control dial.

Daytime Running Lights

The daytime running lights automatically turn on when the engine is running, the parking brake is released, the select lever is out of the “P” position, and the light switch is set to Off, “AUTO”, or “ DRL ”. Always turn on the headlights when it’s dark outside by rotating the dial to the “ OFF ” or “AUTO” position.

TURN SIGNALS

Push fully up for the right turn signal and fully down for left turn signal. Your Subaru also has a one-touch lane changer feature: push slightly up and release to signal a right lane change or push slightly down and release to signal a left lane change.



CONTROLS

WINDSHIELD WIPERS

To turn on the wipers, press the wiper control lever down one position for intermittent, two positions for low speed, or three positions for high speed. When the lever is in the intermittent position, rotate the dial to adjust the operating interval of the wipers. To turn the wipers off, return the lever to the “OFF” position. For a single wipe, move the lever up from the “OFF” position.

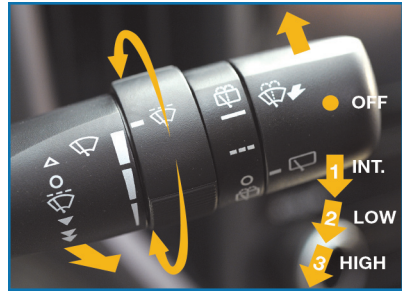

Pull the lever toward you to wash the windshield. The washer will spray and the wipers will operate while you pull the lever.

REAR WINDOW WIPER

Rotate the end of the lever up one position for intermittent, or two positions for continuous operation.

When the lever is in the intermittent position, the wiper operates at intervals corresponding with vehicle speed. When you move the select lever to the “R” position, the wiper will switch to continuous operation. It will return to intermittent when you move the select lever out of “R”.



Rotate the dial up from the continuous operation position or down from the “OFF” position to spray washer fluid. The washer will spray until you release the dial, then return to the previous position and resume operation.

Rear-visibility Camera Washer

To help keep your vision clear, your Subaru comes equipped with a Rear-visibility Camera Washer. To clean the Rear-visibility Camera, simply use the rear window washer.

 For more information, about the Rear Vision Camera and Rear Vision Camera Washer, please refer to page 93 or your Owner’s Manual.



OVERHEAD CONSOLE

- 1 SOS Emergency Assistance:** Press the red “SOS” button to connect with a SUBARU STARLINK® Customer Care Advisor (subscription required). Press and hold the button for about two seconds to cancel the call.

For more information, please refer to page 75 or the SUBARU STARLINK® Safety and Security Owner’s Manual.

- 2 Enhanced Roadside Assistance:** Press the blue “i” button to connect with a SUBARU STARLINK® Roadside Assistance Provider (subscription required). Press and hold the button for about two seconds to cancel the call.

For more information, please refer to page 75 or the SUBARU STARLINK® Safety and Security Owner’s Manual.

- 3 Automatic Illumination:** When the switch is in the “DOOR” position, the map lights illuminate when any door is opened, the doors are unlocked using the remote keyless entry system or keyless access function, or the ignition is turned from “ON” or “ACC” to “LOCK”/“OFF”.

- 4 Lane Departure Warning OFF Switch:** Press and hold this switch for two seconds to turn off Lane Departure Warning and Lane Sway Warning. Press and hold the switch again for two seconds to turn the systems back on.

For more information, please refer to page 92 or the EyeSight® Owner’s Manual.

- 5 Power Moonroof Switch:** Operate this switch to open and close moonroof.

For more information, please refer to page 20 or the Owner’s Manual.

- 6 Pre-Collision Braking System OFF Switch:** Press and hold this switch for two seconds to turn off the Pre-Collision Braking System and Pre-Collision Throttle Management. Press and hold the switch again for two seconds to turn the systems back on.

For more information, please refer to page 92 or the EyeSight® Owner’s Manual.

- 7 Map Lights:** Press a map light to turn it on or off.



GAUGES AND WARNING LIGHTS

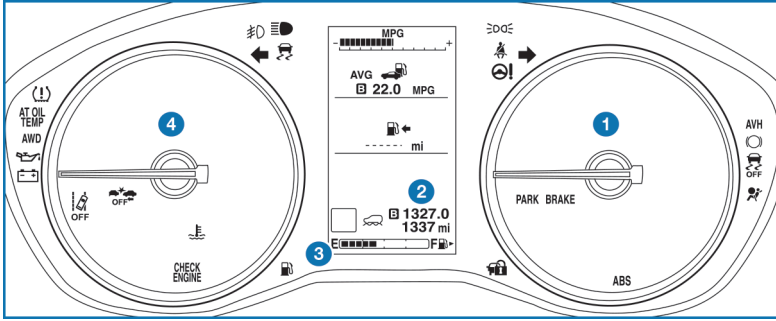

COMBINATION METER





- 1 Speedometer
- 2 Trip meter and odometer
- 3 Fuel gauge
- 4 Tachometer

WARNING AND INDICATOR LIGHTS



Red lights indicate immediate attention is required. Some examples are:

| | | | | | |
|---|------------------|---|-----------|--|--------------|
|  | Seatbelt warning |  | Door open | BRAKE /  | Brake system |
|---|------------------|---|-----------|--|--------------|

Yellow lights indicate caution. Some examples are:

| | | | | | |
|--|----------|--|--------------------------------|--|-----------------------------|
|  | Low fuel |  | Engine oil level warning light |  | Tire pressure warning light |
|--|----------|--|--------------------------------|--|-----------------------------|

Green and blue lights are for information. Some examples are:

| | | | | | |
|--|---------------------------|---|--------------------------|---|---------------------------|
|  | Headlight indicator light |  | Cold coolant temperature |  | High beam indicator light |
|--|---------------------------|---|--------------------------|---|---------------------------|

OPERATING THE VEHICLE

IGNITION SWITCH

The ignition switch has four positions:

LOCK/OFF: You can only insert or remove the key in this position.

ACC (Accessory): Provides power to the radio and accessory power outlets.

ON: All electrical systems are available. The key returns to this position after starting the engine.

START: Turn the key to this position to start the engine.

PUSH-BUTTON IGNITION SWITCH (if equipped)

Each time you press the ignition switch without depressing the brake pedal, the ignition position will change as follows: ACC, ON, OFF.

ACC (Accessory): Provides power to the radio and accessory power outlets. Orange indicator illuminates.

ON: All electrical systems are available. Orange indicator illuminates.

OFF: Power off and indicator off.



STARTING THE VEHICLE

Without Push-button Ignition

To start the engine:

1. Make sure the select lever is in the “P” position.
2. Using the key, turn the ignition switch to “START”.

NOTE: Do not depress the accelerator pedal. Release the key as soon as the engine starts.

With Push-button Ignition

To start the engine:

1. Sit in the driver’s seat with the access key fob.
2. Make sure the select lever is in the “P” position.
3. Depress the brake pedal.
4. When the Engine START/STOP button indicator turns green, briefly press and release the Engine START/STOP button.

OPERATING THE VEHICLE

DRIVING THE VEHICLE

Automatic Transmission Shift Mode

The Continuously Variable Transmission (CVT) is electronically controlled and provides two different driving modes: normal and manual or normal and low.

Normal Mode

When the select lever is in the “D” (Drive) position, the transmission is in normal shift mode. The select lever position indicator in the Combination Meter Display (CMD) shows “D” and the transmission automatically shifts into a suitable forward gear.

Manual Mode (if equipped)

In manual mode, you select the desired gear position to obtain necessary acceleration and engine braking. Move the select lever left from the “D” position into the “M” position to select manual mode. The gear position indicator in the Combination Meter Display (CMD) shows the currently selected gear. Arrow-shaped indicators show when upshifting or downshifting is available. To shift, use the paddle shift control switches behind the steering wheel.

Low Mode (if equipped)

Low Mode is for using engine braking when going down hill, etc. Moving the select lever left into the “L” position from the “D” (Drive) position causes the transmission to change into Low Mode. The shift position indicator shows “L” as the selected gear.



CVT Select Lever

OPERATING THE VEHICLE

Paddle Shift Control Switches (if equipped)

You can shift gears using the paddle shift control switches. To upshift to the next higher gear, pull the “+” paddle on the right toward you. To downshift to the next lower gear, pull the “-” paddle on the left toward you.

You can temporarily shift gears even when the select lever is in the “D” position by pulling either the “+” or “-” paddle toward you. Once vehicle speed stabilizes, the transmission will switch back to normal mode.



SI-DRIVE

Subaru Intelligent Drive (SI-Drive) has 2 possible mode combinations: Intelligent (I) and Sport (S) or Intelligent (I) and Sport Sharp (S#). Each mode is designed for different types of driving:



SI-Drive Switches

Intelligent:

The Intelligent (I) mode provides well balanced performance with greater fuel efficiency and smooth driveability without stress. Power delivery is moderate during acceleration for maximum fuel efficiency.

Sport:

The Sport (S) mode provides the engine power desired by those who want to make the driving experience their own personal adventure.

Sport Sharp:

The Sport Sharp (S#) mode offers an exhilarating level of engine performance and control. The throttle becomes more responsive regardless of the engine speed. Delivering maximum driving enjoyment, this mode is ideal for driving on twisting roads and for merging or overtaking other vehicles on the freeway with confidence.

OPERATING THE VEHICLE

AUTO START-STOP

The Auto Start-Stop system is designed to automatically stop and restart the engine when the vehicle is stationary for a short period of time after the engine has warmed up (while waiting for a traffic light or in a traffic jam, for example). The system operates in order to reduce fuel consumption, exhaust emissions, and undesired idling noise.

Auto Start-Stop System

ON/OFF

If the Auto Start-Stop OFF switch is pressed, operation of the Auto Start-Stop system will be disabled.

NOTE: The system will default to ON once the vehicle has been shut off.



Auto Start-Stop Switch

The Auto Start-Stop indicator light on the combination meter illuminates in yellow when the system is disabled. If the switch is pressed once more, the Auto Start-Stop system will reactivate, and the Auto Start-Stop indicator light will turn off.



System Operation

So that it can be used safely and comfortably, the Auto Start-Stop system is designed to constantly monitor vehicle conditions, the environment inside and outside the vehicle, as well as driver operations, in order to control stopping and restarting the engine.

After the vehicle has been completely stopped by depressing the brake pedal with the select lever in the "D" position, the engine will be automatically stopped and the green indicator will illuminate in the combination meter.



If you release the brake pedal with the select lever kept in the "D" position, the engine will be automatically restarted. The indicator light will turn off when the system restarts the engine.

There are several operating conditions for this system to operate as intended.

 For more information, please refer to the Owner's Manual.

OPERATING THE VEHICLE

Fuel Saving Display

Once the Auto Start-Stop System has stopped the engine, the Fuel Saving Screen will display in the Combination Meter Display (CMD), showing how much time the engine was off in the top line and the amount of fuel saved in the bottom line. These are the total stop time and fuel saved since the trip meter was reset.

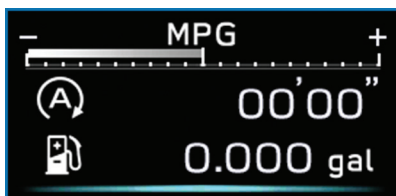

No Activity Detected Indicator Light

If the operational conditions are not met when the vehicle is stopped, the engine will not stop and the white Auto Start-Stop No Activity Detected indicator light will illuminate. It will turn off when the brake pedal is released.





Auto Start-Stop Warning Light

The Auto Start-Stop warning light will illuminate in yellow when initially turning the ignition switch to the "ON" position. The light will turn off after the engine has started.



NOTE: If the Auto Start-Stop warning light does not turn off after the engine has started or is flashing, the Auto Start-Stop system may be malfunctioning. We recommend that you contact your authorized SUBARU Retailer for an inspection.

| INDICATOR | PATTERN | CONDITION |
|---|-----------------|---|
|  | Solid green | This indicator light illuminates when the engine has been temporarily stopped by the Auto Start-Stop system. It will turn off when the engine is restarted. |
|  | Solid White | Operational conditions have not been met, the engine will not stop and this light will illuminate. The light turns off once the brake pedal is released. |
|  | Solid Yellow | This light indicates that the system has been turned off. The light will turn off once the system is turned back on. |
| | Flashing Yellow | A fault has been detected with the Start-Stop system. Please contact your authorized Subaru Retailer. |

OPERATING THE VEHICLE

ELECTRONIC PARKING BRAKE (EPB)

To apply the parking brake, depress the brake pedal and pull up the parking brake switch. The indicator light on the parking brake switch will illuminate and "PARK" will appear in the Combination Meter.

To release the parking brake manually, depress the brake pedal and push the parking brake switch down. To automatically release the parking brake, gently press the accelerator pedal with the select lever in the "D" or "R" position.

NOTE: Automatic parking brake release will not work unless all the doors are closed and your seatbelt is fastened.



OPERATING THE VEHICLE

Auto Vehicle Hold (AVH)

Auto Vehicle Hold gives your feet a break by automatically holding your Subaru in place when at a complete stop, such as a traffic signal, even after you release the brake pedal. Press the Auto Vehicle Hold switch on the center console to turn on the function. The AVH indicator in the combination meter will illuminate.

While your Subaru is being held by this function, the operation indicator in the combination meter will illuminate. The function is canceled when you depress the accelerator pedal or the brake pedal.

Press the switch again to turn it off. The function works with the select lever in either the “D” or “R” position.

NOTE:

- For this system to work your seatbelt must be fastened.
- Make sure to turn off this function before entering an automatic car wash.



| ICON | MODE |
|--|--------------------------------|
| AVH | Auto Vehicle Hold ON |
|  | Auto Vehicle Hold IN OPERATION |

X-MODE® (if equipped)

X-MODE® is the integrated control system of the engine, All Wheel Drive, and Vehicle Dynamics Control (VDC) systems for driving with bad road conditions. Using X-MODE®, you can drive more comfortably even in slippery road conditions, such as mud or snow, including uphill and downhill. You can activate the system when the vehicle speed is less than 12 mph. If the vehicle speed reaches 25 mph, the X-MODE® system is canceled and can be reactivated once the vehicle speed is lower.



MFD X-MODE Display

OPERATING THE VEHICLE

X-MODE® Standard System

To activate the X-MODE® system, press the X-MODE® switch. While the system is active, the X-MODE® indicator appears, and the Multi-Function Display shows steering direction, vehicle angle, and power distribution. To deactivate X-MODE®, press the X-MODE® switch again.

In certain situations, such as navigating a vehicle stuck in mud or snow, it may be helpful to allow more wheel spin by turning off the VDC system. To turn off the VDC system, turn the Vehicle Dynamics Control OFF switch to the left. Turn the Vehicle Dynamics Control OFF Switch back to “Normal” to reactivate the VDC system.



Standard

X-MODE® Dual Mode System

To activate the X-MODE® system, turn the switch to the left for SNOW/DIRT or to the right for D.SNOW/MUD. While the system is active, the X-MODE® indicator appears, and the Multi-Function Display shows steering direction, vehicle angle, and power distribution. To deactivate X-MODE®, press the X-MODE® switch.

- SNOW/DIRT is suitable for driving on slippery road surfaces such as snow or gravel, where the points of contact between the tires and road surface are visible.
- D.SNOW/MUD provides maximum torque from the engine and the optimal amount of slip in the driving wheels, enabling the vehicle to free itself more effectively. It is suitable for driving on a roads where the tires can become buried, such as deep snow, dry sand, or muddy roads.



Dual Mode

Hill Descent Control (HDC)

This function helps maintain a constant vehicle speed when driving down steep hills or declines. HDC is automatically engaged with X-MODE® and functions with the select lever in the “D” or “R” position.

TURNING OFF THE VEHICLE

Without Push-button Ignition

To stop the engine:

1. Stop your Subaru completely.
2. Move the select lever to the “P” position.
3. Turn the ignition switch to “OFF”.

NOTE: The front windows will remain active for about 40 seconds and the SUBARU STARLINK® Multimedia System will remain on for about three minutes or until a door is opened, whichever occurs first.

With Push-button Ignition

To stop the engine:

1. Stop your Subaru completely.
2. Move the select lever to the “P” position.
3. Press the ignition switch.

NOTE: The front windows will remain active for about 40 seconds and the SUBARU STARLINK® Multimedia System will remain on for about three minutes or until a door is opened, whichever occurs first.

REFUELING

FUEL FILLER LID

The fuel filler lid is located toward the rear of the passenger side. To open the lid:

1. Make sure your Subaru is stopped and the select lever is placed in PARK. Then turn the ignition to the "LOCK"/ "OFF" position.
2. The fuel filler lid is automatically unlocked when the ignition is moved to the "LOCK"/"OFF" position, or by unlocking using the access key fob/transmitter or door handles.
3. Push the rear side of the lid.
4. When the lid opens slightly, open it further by hand.

While refueling, place the fuel filler cap on the cap holder inside the lid.

After refueling, put the cap back on and turn it clockwise until you hear a clicking noise. Be certain not to catch the tether under the cap while tightening.

To close the lid, press it until you hear it latch.

NOTE: If the fuel filler cap is not tightened until it clicks or if the tether is caught under the cap, the Check Engine warning light may illuminate.



Fuel Filler Lid and Cap

FUEL

Use regular unleaded gasoline with an octane rating of 87 AKI or higher. Do not use fuels with more than 10% ethanol.

 For more information, please refer to the Owner's Manual.

FUEL CAPACITY

| | Capacity |
|------------------------|-----------------|
| Full Fuel Tank | 16.6 US gallons |
| Low Fuel Warning Light | 2.5 US gallons |

PASSENGER/CARGO AREAS

FOLDING THE REAR SEATS

First, lower the headrests. Then, pull up on the release knob until you can see the red at the bottom of the knob and fold down the seats.

To return the seatback to its original position, raise the seatback until it locks into place. You will no longer be able to see the red at the bottom of the knob when the seat is locked.



Seat Release Knob

If equipped, release latches are located on either side of the cargo area. Pull the release latch on the seat side that you want to fold down.



Seat Release Latch

CHILD SAFETY LOCKS

The child safety locks are located on the inside edges of the rear doors. In the locked position, the rear doors can only be opened from the outside.



PASSENGER/CARGO AREAS

LATCH/ANCHOR

Your Subaru is equipped with Lower Anchors and Tethers for Children (LATCH). For maximum safety, first carefully read the LATCH system instructions from the device manufacturer, as well as the installation instructions in your Owner's Manual, to properly install the LATCH compatible restraint system. Use the appropriate seatbelts or anchorages provided in your Subaru. Children age 12 and under must properly occupy the rear seat at all times.

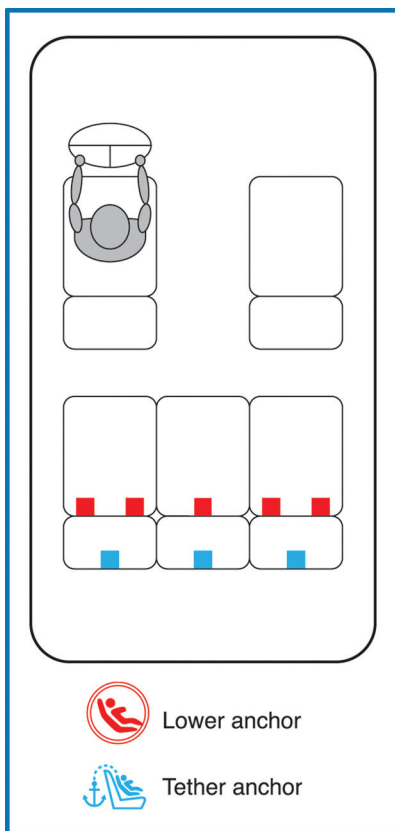

REAR SEAT REMINDER

The Rear Seat Reminder system assists you in preventing a child or pet from being left in your Subaru. The system monitors the opening and closing of the rear side door. It does not physically sense the presence of a child or pet.

The system turns on if your Subaru is started within 30 minutes of a rear side door opening or closing. It also turns on if a rear side door is opened and closed when your Subaru is running and stationary. The system remains on if your Subaru is turned off and back on again within 30 minutes and the rear side doors remained closed.

When you turn your Subaru off, the system warns you audibly and with a “Reminder, Look In Rear Seat” message in the Combination Meter Display (CMD).

The system operates only one time with each ignition cycle and opening and closing of a rear side door. You can turn the Rear Seat Reminder off in the Combination Meter Display (CMD).

Passenger Occupant Detection and Seatbelt Reminders

To help keep your passengers safe, your Subaru has a passenger occupant detection and seatbelt reminder system for each seat, including the rear seats.

If passengers in the rear seats do not fasten their seatbelts while the ignition is in the “ON” position, the seatbelt warning lights illuminate or blink for the specific seat, and a warning chime may sound.

 For more information, please refer to “Seatbelt Warning Light and Chime” in your Subaru Owner’s Manual.

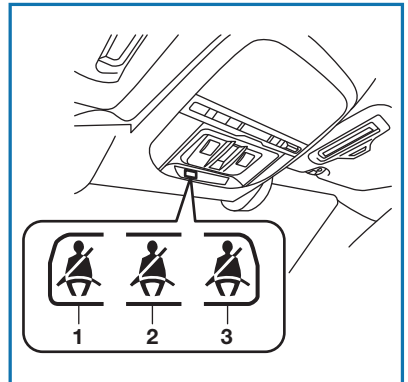

PASSENGER/CARGO AREAS

CARGO COVER (if equipped)

Use the detachable cargo cover to protect contents in the cargo area from direct sunlight. Pull the cover toward the rear of your Subaru and insert both ends of the cover into the guides.

Store the cover under the floor of the cargo area when not in use. Instructions for operation are included on the cargo cover housing.



Cargo Area and Cover

SPARE TIRE AND JACK

A jack and other maintenance tools are stored in the tool bucket in the center of the spare tire, located under the cargo floor.

Your vehicle is equipped with the following maintenance tools.

- Jack
- Jack handle
- Screwdriver
- Towing hook (eye bolt)
- Wheel nut wrench



 For more information, please refer to “Maintenance Tools” in your Owner’s Manual.

ENGINE COMPARTMENT

HOOD PROP

The hood prop is located in the left front of the engine compartment. Unfold it and insert the end into the slot marked with an arrow.

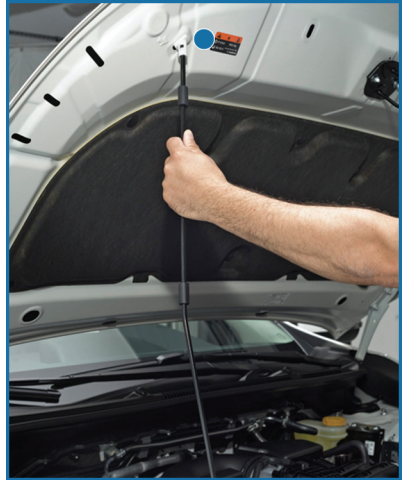

ENGINE COMPARTMENT

2.5 L ENGINE

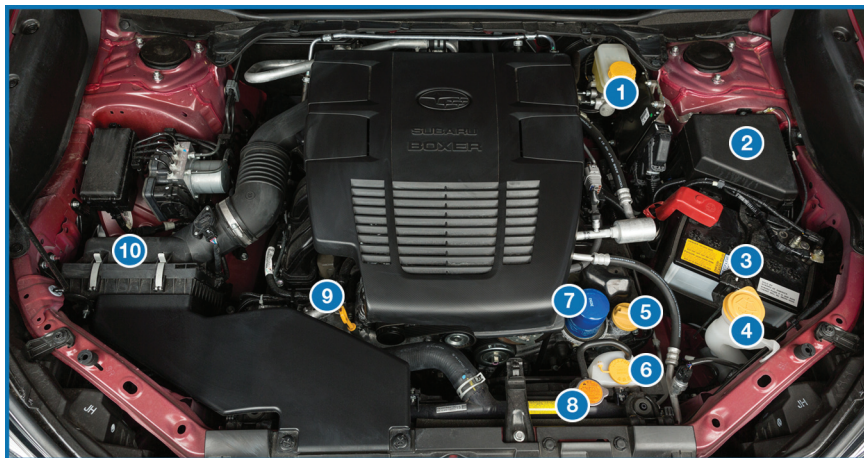

- | | | | |
|---|------------------------|----|--------------------------|
| 1 | Brake Fluid Reservoir | 6 | Engine Coolant Reservoir |
| 2 | Main Fuse Box | 7 | Engine Oil Filter |
| 3 | Battery | 8 | Radiator Cap |
| 4 | Windshield Washer Tank | 9 | Engine Oil Dipstick |
| 5 | Engine Oil Filler Cap | 10 | Air Cleaner Element |
- ⓘ Please refer to the Warranty and Maintenance Booklet for recommended replacement intervals.

ADDITIONAL SPECIFICATIONS

NEW VEHICLE BREAK-IN

The performance and long life of your Subaru are dependent on how you handle and care for your Subaru while it is new.

Follow these instructions during the first 1,000 miles:

- Do not race the engine.
- Do not drive at one consistent engine or vehicle speed, either fast or slow.
- Avoid starting suddenly and rapid acceleration, except in an emergency.
- Avoid hard braking, except in an emergency.

ENGINE OIL

Use 0W-20 synthetic, with one of the following specifications:

- API classification SN or SN PLUS with the words "RESOURCE CONSERVING".
- ILSAC GF-5, which can be identified with the ILSAC certification mark (Starburst mark).

ENGINE OIL CAPACITY

4.4 US quarts (during oil and filter change).

When the level is at the "low" mark, add approximately 1 quart of engine oil in through the filler cap to bring the oil level to the "full" mark. For filler cap location see the engine compartment on page 50.

- 1 Full Level
- 2 Low Level

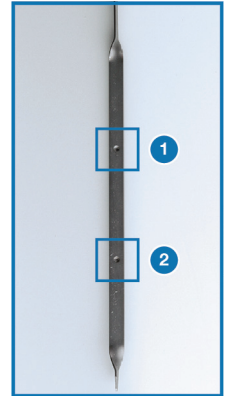

ADDITIONAL SPECIFICATIONS

ROOF RAIL CAPACITY

| CROSS BARS DYNAMIC | ROOF RAILS DYNAMIC | ROOF RAIL STATIC |
|--------------------|--------------------|------------------|
| 150 Pounds | 176 Pounds | 700 Pounds |

 For more information, please refer to your Owner's Manual.

TRAILER TOWING CAPACITY

| Maximum total trailer weight* | Maximum tongue weight* |
|-------------------------------|------------------------|
| 1,500 pounds | 150 pounds |

*Towing a trailer with brakes.

NOTE:

- For models equipped with the BSD (Blind Spot Detection) and RCTA (Rear Cross Traffic Alert) driving support systems, when towing a trailer, it may be necessary to press the BSD/RCTA OFF switch to deactivate the system. The system may not operate as expected due to obstruction of the radar waves. For details about the BSD/RCTA OFF switch, refer to page 94 and/or your Owner's Manual.
- For models equipped with the RAB (Reverse Automatic Braking) driving support system, when towing a trailer, it may be necessary to press the RAB button to deactivate the system. The system may not operate as expected due to obstruction of the sonar waves. For details about the RAB button, refer to page 95 and/or your Owner's Manual.

 Please refer to your Owner's Manual for complete details, especially if you plan to use this vehicle for regular towing.

ADDITIONAL SPECIFICATIONS

TIRE PRESSURE MONITORING SYSTEM (TPMS)

Your Subaru has a Tire Pressure Monitoring System (TPMS). Individual tire pressure can be found in the Combination Meter Display. Use the “i/Set” switch to display the TPMS screen.

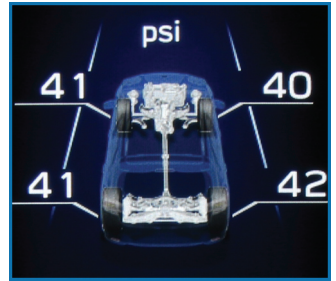

TPMS Screen

Tire pressure specification is listed on the tire specification placard located on the driver's side door pillar.



Tire Specification Placard

STARLINK OVERVIEW

OVERVIEW OF YOUR MULTIMEDIA SYSTEM

SUBARU STARLINK® Multimedia combines the radio along with the ability to connect your phone* through Bluetooth® to the multimedia system for making calls, sending text messages and listening to your favorite songs on your phone.

* Compatible smartphone and application required. For applications to operate, latest version of each application required. Data provided by smartphone is displayed on the Touchscreen. Some state laws prohibit the operation of handheld electronic devices while operating a vehicle. Smartphone apps should only be launched when vehicle is safely parked. Your wireless carrier's rates may apply.

Various Systems

Depending on your model and trim level there are several types of SUBARU STARLINK® Multimedia systems. Some of the functions described in this guide will vary by system.

- 6.5-inch Multimedia Plus
- 8.0-inch Multimedia Plus
- 8.0-inch Multimedia Navigation

BUTTONS

Radio Functions

1 Power/Volume Control
Press the power/volume control knob to mute or un-mute the audio. Rotate the knob left to decrease or right to increase the volume.

2 Radio
Press the RADIO button to display the AM/FM/SXM screen. The different tuner modes can be selected by touching the source you want to hear.

3 Media
Press the MEDIA button to display the media screen. Select the media source you want to hear. Connected media will display in white.

4 Tune
Rotate the knob to change the radio station or select the next track/media file. Press and hold the knob to display the sound settings screen.

5 Seek
Press the seek up or seek down button to seek the next or previous radio frequency. You can also use the seek up or down buttons to select different audio tracks from media sources. Press and hold to fast-forward or rewind.



CD Player Functions

6 Load

Insert the disc into the loading slot. The CD will automatically be drawn in and begin playing the first track.

7 Eject

Press the Eject button on the left side of the loading slot to remove the CD from the player.

Other Functions

8 Home

Displays the Home screen apps. The Home screen allows you to customize which apps appear and rearrange the icons in a personalized order.

9 Map (if equipped)

Displays the map and navigation features available on the screen.

10 Apps

Displays the installed apps that are available on your vehicle.

Controlling the Volume

Adjusting the Volume: Turn the VOLUME knob to adjust the volume. The volume stays at the level you set after an ignition cycle.





Muting the Volume: You can mute the audio system by pressing the volume knob once, and un-mute the audio by pressing the knob again. It will un-mute automatically after an ignition cycle.

Turning the System Off: To turn the audio system off, press and hold the volume knob for about three seconds. The system remains off after an ignition cycle. Press the volume knob again to turn the audio system back on.

STARLINK OVERVIEW

TOUCHSCREEN

Operations are performed by touching the screen directly with your finger.

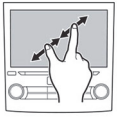
| MOTION | ACTION | USE |
|---|--|---|
|  | Touch Quickly touch and release once. | Changing and selecting various settings |
|  | Double Touch with one finger* Quickly touch and release twice with one finger. | Enlarging the scale of the map screen |
|  | Double Touch with two fingers* Quickly touch and release twice with two fingers. | Reducing the scale of the map screen |
|  | Drag** Touch and drag your finger on the screen to move the screen to the desired position. | <ul style="list-style-type: none">• Scrolling the lists• Scrolling the map screen* |
|  | Swipe** Quickly move the screen by swiping with your finger. | <ul style="list-style-type: none">• Scrolling the lists• Scrolling the map screen* |
|  | Pinch* Move your two fingers further apart (pinch-out) to zoom in on the map. Move your two fingers closer together (pinch-in) to zoom out on the map. | Changing the scale of the map screen |

* 8-inch with Navi system only

** The operations may not be performed on all screens.

STEERING WHEEL CONTROLS

- 1 Presets/Skip:** Press to toggle through your preset radio stations or change a track/media file. Press and hold to scan radio stations or fast-forward/rewind media files.
- 2 Volume:** Push the switch up/down to increase/decrease volume.
- 3 Source:** Press the source button to change the audio sources between radio modes and media modes.
- 4 INFO:** Press to operate the Multi Function Display.
- 5 Call/Voice Recognition:** Press to receive/end a call without taking your hands off the steering wheel. Press the talk button to start voice recognition. If connected to an iPhone, press and hold the talk button to initiate Siri.



Starlink Audio Controls

VOICE RECOGNITION

With SUBARU STARLINK®, simple voice commands can control features like navigation, entertainment, phone calls, and, on select models, climate control. A microphone is located in the overhead console; however, you do not need to speak directly into it to activate the voice command features.

Visit www.subaru.com/engineering/starlink/multimedia.html for more information.

Press the Voice Recognition button on the steering wheel to start the voice recognition system. Press and hold the button to cancel the system.

For help with what features are available with voice recognition, press the "Help" button on the screen or press the voice recognition button and say "Help".



Scan to learn more about **Subaru Multimedia**.

STARLINK OVERVIEW

Tips

The system may not recognize the voice command due to various types of interference. Some causes for voice command interference are:

- The command is spoken too quickly or at a low or high volume.
- The command is incorrect or unclear.
- The window is open, the climate control system is set on high, or the ventilation is directed toward the microphone.
- Passengers are talking while the command is spoken.

In some cases, you may not be able to use voice commands if the system cannot properly recognize the command. For example, the command is incorrect or unclear.

NOTE: The system is designed to recognize a variety of commands, but certain words, accents or speech patterns may be difficult for the system to recognize.

Google Assistant: May not work with all devices or may not be compatible with the audio system.

Siri Eyes Free: Press and hold the Voice Recognition Button when your phone is connected via bluetooth for Siri Eyes Free.

Common Commands

Below are examples of common commands that can be used with the voice recognition system. Please refer to your SUBARU STARLINK® Owner's Manual for a complete list.

| VOICE COMMAND | FUNCTION | EXAMPLE |
|--|--|---|
| Dial [Number] | Places a call to the phone number | Dial 555-123-4567 |
| Call [Name] [Phone Type] | Places a call to the contact name and phone type of the contact from the phonebook | Call John Doe mobile |
| Navigate to [House Number, Street, City, State] ¹ | Sets a destination to the address | Navigate to 1234 Main Street, Lincoln, Washington |
| Show Map ¹ | Displays the map screen | Show Map |
| Where am I ¹ | Displays current location on map | Where am I |
| Tune to [Frequency] (AM / FM) | Switches to AM/FM and tunes to spoken frequency | Tune to 99.5 FM |
| Preset [Number] | Switches to the preset channel | Preset 3 |
| Satellite Channel [Name / Channel Number] | Switches to satellite channel number | Satellite Channel Prime Country 55 |

STARLINK OVERVIEW

| VOICE COMMAND | FUNCTION | EXAMPLE |
|--|---|-----------------------|
| Set Fan Speed to [1-7] ² | Sets the fan speed to the spoken fan speed | Set fan speed to 4 |
| Set Temperature to [Number] ^{2,3} | Sets the temperature to the spoken temperature | Set temperature to 70 |
| Help | Changes to help screen | Help |
| Phone Help | Displays a list of voice commands related to controlling your phone | Phone Help |
| Media Help | Displays a list of commands related to the media | Media Help |
| Radio Help | Displays a list of commands related to the radio | Radio Help |
| Navigation Help ¹ | Displays a list of voice commands related to navigation | Navigation Help |

1 8.0-inch Multimedia Navigation system only

2 8.0-inch Multimedia Plus and 8.0-inch Multimedia Navigation system only

3 When the A/C is off, the A/C setting will not change even if the voice command is accepted

STARLINK HOME

HOME SCREEN ICONS

Phone – Allows you to place and receive calls and text messages.

Map – Allows you to enter a destination and have route guidance to get you where you are going.

Settings – Allows you to change the settings to your personal choice for select systems inside the vehicle.

Add Shortcut – Allows you to add icons for various functions to the home screen.

Apps – Entertainment and convenience applications that can be used to enhance your driving experience. The apps included are: MySubaru, Pandora®, Travel Link®, Android Auto™, SUBARU STARLINK®, aha™, and Apple Car Play®.

Media – Allows you to play CDs, USB/iPod music, or Bluetooth® audio by connecting to the device.

Radio – Allows you to select a station to listen to as well as pause and playback live radio.

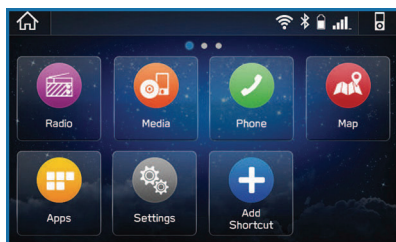

Home Screen Icons



Scan to learn more
about

SUBARU STARLINK®.

REARRANGING ICONS

You can rearrange the icons on the Home Screen when the Home Screen Shortcuts function is turned on. You can turn on the Home Screen Shortcuts function by selecting “Settings”, then the “General” tab.

To rearrange icons on the Home Screen:

1. Select and hold the shortcut icon you want to move.
2. Drag the icon to the desired position and release.
3. To delete an icon, drag the icon to the bottom of the screen and release.

ADDING SHORTCUTS

You can add shortcut icons for various functions to the Home Screen when the Home Screen Shortcut function is turned on. You can turn on the Home Screen Shortcuts function by selecting "Settings", then the "General" tab.

To add shortcut icons to the Home Screen, press the "Home" button.

1. Select "Add Shortcut".

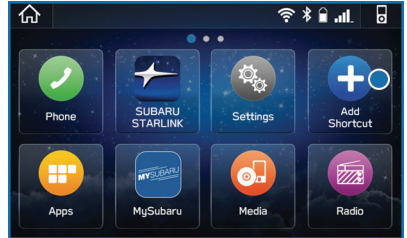

2. Select the desired function.

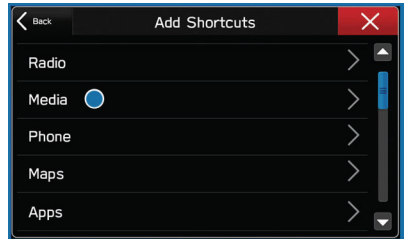

3. Select the desired shortcut function.
4. Check that the shortcut icon is displayed on the Home screen.

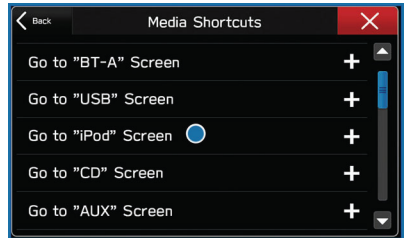

DRIVER PROFILE

CREATING A DRIVER PROFILE

Creating a Driver Profile provides many benefits beyond just pairing a phone. The profile records and remembers station presets, sound preferences, home and work address (if equipped with navigation), phone favorites, screen icons and placement, and the background wallpaper.

To create a driver profile:

1. On the Home screen, select “Settings”.
Then, in the General menu, select “Driver Profile”.

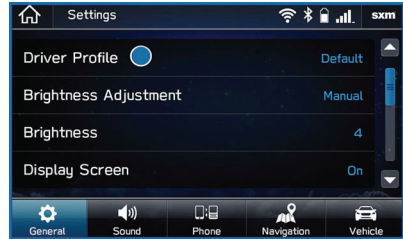

2. Select “Add New Profile”.

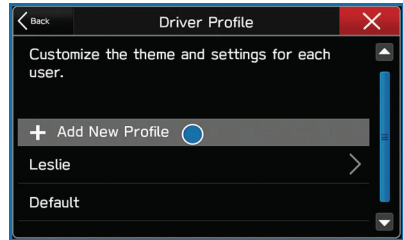

3. Select “Enter Name” to display the keyboard screen then type your name. Now select “Next” on this screen and the following screen.

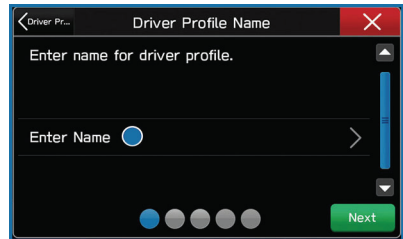

DRIVER PROFILE

4. Select a paired phone or pair a new phone (see page 108 and page 112 in the How To Appendix). Then select “Next”.

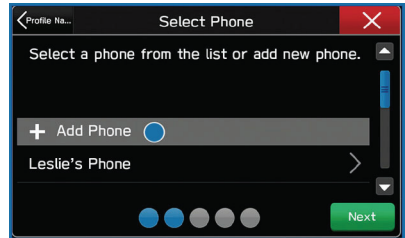

5. Enter a Home Address and Work Address (if equipped with navigation). Then select “Next”.

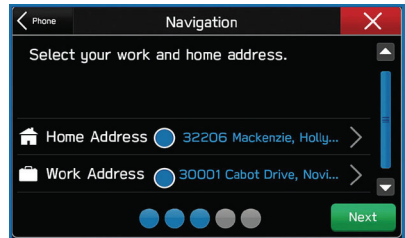

6. Select a Wallpaper then select “Next”.
7. Select “Finish”.

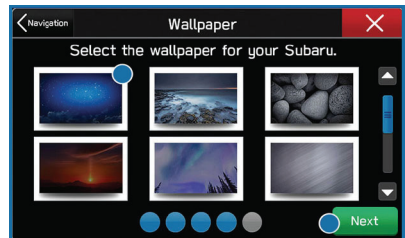

Retrieving a Driver Profile

The system automatically retrieves the profile once you are in your Subaru with the STARLINK® multimedia system on and your phone's Bluetooth® active. You can also manually retrieve or change the profile by following these steps:

1. Press the “Home” button and then select “Settings”.
2. In the General menu, select “Driver Profile”.
3. Select the profile you want to use, and then select “Activate”.

MULTIMEDIA

RADIO

AM/FM Radio

Your Subaru is equipped standard with AM/FM radio, including HD Radio®. HD Radio® technology allows you to receive digital broadcasts (where available) in addition to analog broadcasts. Digital broadcasts provide free, crystal clear audio with no static or distortion.

Visit www.hdradio.com for more information and a guide to available radio stations and programming.

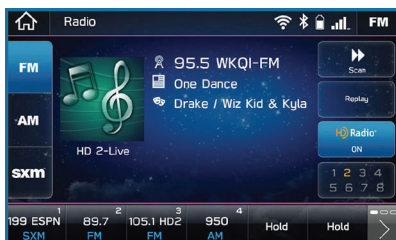

Scan to learn more about HD Radio.

Satellite Radio

A SiriusXM® Satellite Radio is a tuner designed exclusively to receive broadcasts provided under a separate subscription. After a free trial period, a subscription is necessary to continue service.

For more information or to subscribe, visit www.siriusxm.com.

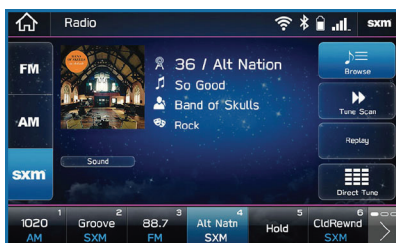

Scan to learn more about SiriusXM Radio.

Presets

You can preset 18 stations. Presets can be set for SiriusXM®, FM, or AM stations, allowing you to switch among the three with the press of a single button. To preset a radio station:

1. Tune to the desired channel.
2. Press and hold the desired preset station button at the bottom of the screen.

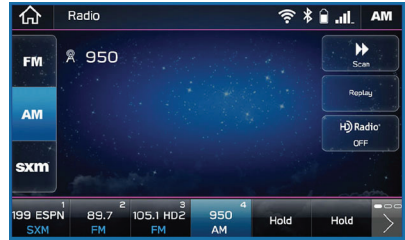

MEDIA

Bluetooth®

Your Subaru has Bluetooth® hands-free technology to manage your phone and audio systems. Bluetooth®-enabled mobile phones link directly through your Touchscreen automatically once connected. Bluetooth® Hands-free allows you to receive and initiate calls, or play music directly from your device while keeping it stowed for safety.

For step-by-step instructions on how to pair a Bluetooth® device to the Touchscreen, please see page 108 for Android devices or page 112 for Apple devices. A QR code and link to more information on pairing a Bluetooth® device can also be found on page 66.

CD

The CD player holds a single disc. To access the CD menu, put a CD in the player or select the CD icon on the “Media” Screen. Depending on the CD format, the CD album art work may appear on the Touchscreen.

USB / iPod

You can plug in a USB memory storage device or iPod into the USB ports. This will bring up the media screen with controls. If using an iPod, make sure to use an Apple certified cable or MFi certified cable for proper operation.

Aux Input

The Aux jack is a port that allows input from an audio device such as MP3 players, portable music players, and iPods. To access the Aux menu, plug in the device to the Aux jack and the menu will appear, or select the Aux menu from the “Media” Screen.

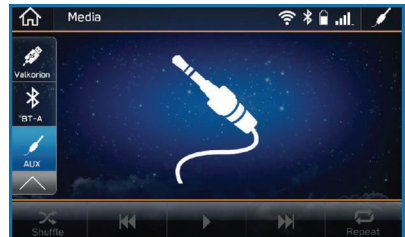

PHONE

PAIRING A PHONE

To begin using your Bluetooth® Hands-free device you must first pair your phone with the system. Phone pairing provides access to the contact list on your phone and allows you to use the voice recognition system to make and receive calls. The system can also read incoming text messages, as well as allowing you to reply to texts or send short messages. The system automatically reconnects to your Bluetooth® device and will remember your driver profile.

 For instructions on how to pair your phone to the Touchscreen, see page 108 for Android devices or page 112 for Apple devices.

Visit <https://www.subaru.com/owners/index.html> for complete details on what is available by connecting a phone to the Touchscreen.



Scan to learn more
about **Pairing
a Phone.**

MAKING A CALL

Once your phone is paired, you can make a call through voice recognition by pressing the “Voice Recognition Switch” on the steering wheel. After pressing the “Voice Recognition Switch”, wait for the “Voice Guidance” screen to appear on the Touchscreen and say “Call [name and phone type]” or “Dial [number]”.

To make a call from the Touchscreen, start by pushing the “Home” button and then select “Phone”. After the phone screen displays, select the method you would like to use to make a call.

- Overview – Allows you to call the last number.
- Favorites – Allows you to place a call to one of your favorites on your phone.
- Recent – Allows you to call someone that has recently called you or that you called.
- Keypad – Allows you to dial any number you would like.
- Phonebook – Displays the phonebook from your phone.

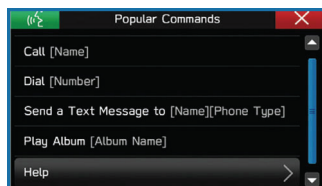

RECEIVING A CALL

To receive a call, press the “Talk Switch” on the steering wheel or the “Talk Button” on the Touchscreen.

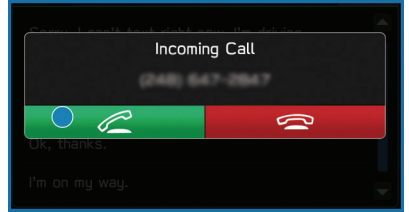

To reject a call, press the “End Switch” on the steering wheel or the “End Button” on the Touchscreen.

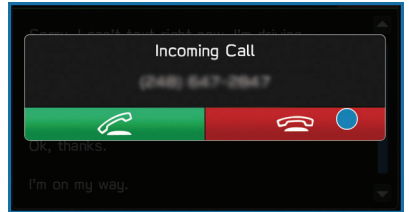

PHONE

TEXT MESSAGES

Received messages can be forwarded from the connected Bluetooth® phone, enabling checking and replying using the system. To use this function, it is necessary to set the phonebook download function to ON. When a Short Message Service (SMS)/ Multimedia Messaging Service (MMS) is received, the incoming message screen pops up with sound and is ready to be retrieved using the Touchscreen. Select “Play” to listen to the message or “View” to see the message on the screen. This button may not be available if the vehicle is moving.

If there is more than one unread message, a screen will appear allowing you to either view your inbox or ignore the message.

Depending on the type of Bluetooth® phone connected, received messages may not be transferred to the message inbox. If the phone does not support the message function, this function cannot be used.

Depending on the Bluetooth® phone type, the screen display may differ, and it may not be possible to use certain functions.

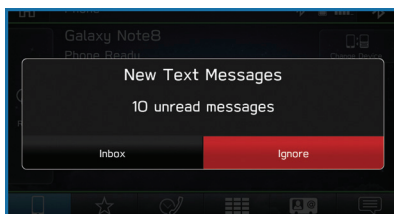
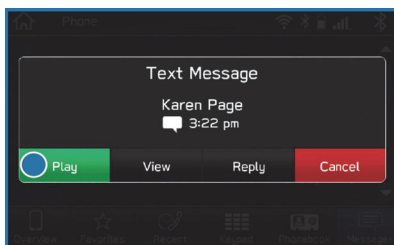

SUBARU STARLINK® IN-VEHICLE APPS

SUBARU STARLINK® Multimedia offers advanced connectivity through Apple CarPlay®, Android Auto™, aha™ and Pandora® apps. Wireless pairing and hands-free smartphone operation allow for safe and easy connection to your favorite apps and content. You can access news, navigation, music, podcasts, and more through the available SUBARU STARLINK® app.

For a complete list of all the apps available, visit www.subaru.com/engineering/starlink/multimedia.html.



Scan to learn more about **Subaru Multimedia**.

aha™ by HARMAN

aha is a cloud-based application that connects to the system and gives you access to your favorite web content safely and easily. There are thousands of available stations spanning internet radio, personalized music, audiobooks, Facebook, Twitter, restaurant and hotel searches, weather and more. For more about aha, visit www.aharadio.com.

To use the aha application, connect your iPhone or Android device via Bluetooth®. When connecting an iPhone or Android device with the aha application installed, you can control, view, and hear aha content through the system.

With the 8.0-inch Multimedia Navigation function, you may also display Points Of Interest (POI) information from the aha application on the map screen and route to these POIs.

Pandora®

Pandora is a free, personalized radio that offers effortless and endless music enjoyment. To use the Pandora application, first install the Pandora application on your smartphone. Then connect your iPhone or Android device via Bluetooth®.

NOTE: Some vehicles might be incompatible with this app depending on difference between models and software version.



Scan to learn more about **aha radio** or to get the app.

APPS

Android Auto™

Android Auto can be used to view maps, play music, and place calls by connecting your Android device to the system. You can also run supported applications. To use the Android Auto application, connect your Android device to the USB port.

 For more information on connecting your phone, please refer to page 116.

For details on services or operations, visit the Android Auto sites: www.android.com/auto/ or www.support.google.com/androidauto/

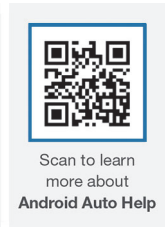
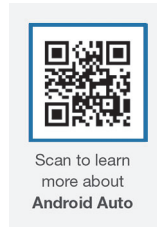

Apple CarPlay®

Apple CarPlay can be used to view maps, play music, and place calls by connecting your iPhone to the system. You can also run supported applications. To use the Apple CarPlay application, connect your iPhone to the USB port.

 For more information on connecting your iPhone, please refer to page 118.

For details on services or operations, check the Apple CarPlay site: www.apple.com/ios/carplay/

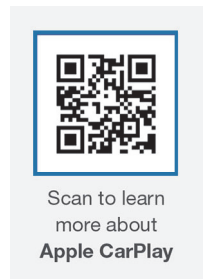

SiriusXM® Travel Link

SiriusXM® U.S. satellite and data services are available only in the 48 states of the contiguous USA and DC.

Data service information, which is comprised of sports, weather, stocks and fuel prices, can be received via the SiriusXM® Radio, with the option to turn on or off weather alerts.

To receive the data service information in the vehicle, a subscription to the SiriusXM® Satellite Radio Service is necessary following a free trial.



SUBARU STARLINK® MOBILE APP

There are several key applications that can be loaded to your phone and used while in your Subaru to help you while you drive. You must also download and log in to the SUBARU STARLINK® app on your phone to use these apps.

To download the SUBARU STARLINK® app, go to the Apple App Store or the Google Play Store and search for SUBARU STARLINK® in the menu.

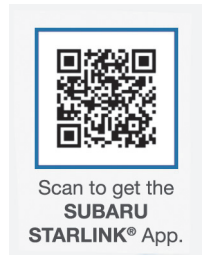
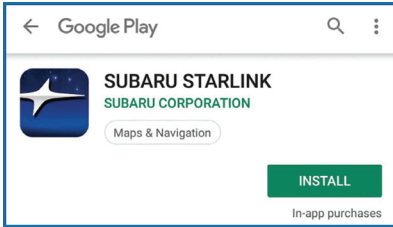

Below are a few apps that you may find helpful.

Quick Reference Guide

This is the digital version of the original printed Getting Started Guide that is standard in all new Subaru vehicles. The app features In-Vehicle Help (IVH) that provides an interactive, searchable, model-specific concierge through the Touchscreen.

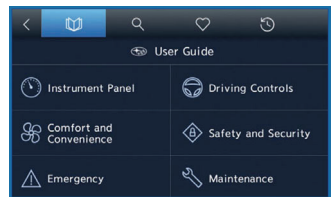
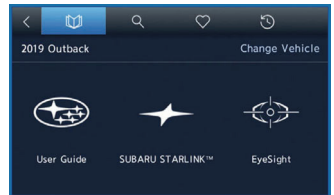

Yelp

Yelp is a local guide powered by a community of reviewers that helps you find great local businesses.

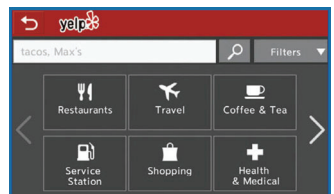

APPS

Chimani

Get the most comprehensive guide to all 417 national parks in the United States. Quickly learn about each park's history and highlights.

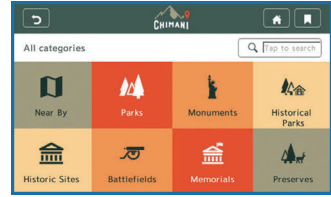

eBird

Exclusive to Subaru vehicles, the eBird app tells you what birds are being seen near you in real time. Based on a database of millions of bird sightings, eBird acts as a "digital coach" for finding birds. Use the app to decide where to go based on the distance to a great birding location and the species being seen there. For example, the app may tell you the nearest sighting of a certain species is 8 miles away and navigate you to the last place it was seen. Full-screen photos help you confirm your sightings.

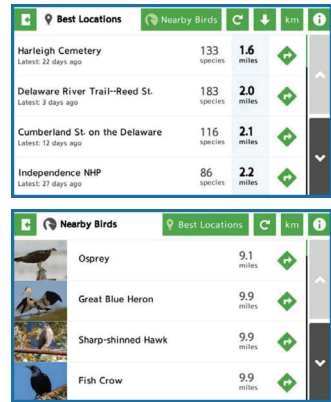

MYSUBARU

Whether you're on the road or planning adventures, the MySubaru app makes loving every part of owning your Subaru easy. Although the mobile app is great when you are on the go, you can also visit www.MySubaru.com from your computer to access the same functions and to aid in planning your trip before you leave.

You can download the MySubaru app from the Google Play Store or the Apple App Store on your phone by searching MySubaru.

By creating an account, you can:

- Schedule service with a preferred Subaru retailer
- Get vehicle service reminders, recall alerts, and exclusive coupons
- Track and record your service history
- Access resources like your owner's manuals, how to videos and more
- Have access to SUBARU STARLINK® Safety and Security features (must have an active SUBARU STARLINK® subscription)
- Get help from 24-hour roadside assistance (24-hour roadside is included in standard 3-year warranty, and after 3 years with a Concierge package)



Scan to get the
MySubaru App.

Service Appointment Scheduler

The SUBARU STARLINK® Service Appointment Scheduler can help you set an appointment from the MySubaru website, Mobile App or the vehicle's Touchscreen. Getting your Subaru vehicle to the Subaru professionals for service is easy, no matter where you are. If you are away from your preferred Subaru retailer for service, you can always use Service Appointment Scheduler to locate any of our certified Subaru retailers near your location.

STARLINK® Service Appointment Scheduler on your Touchscreen is a convenient way to set a service appointment. Simply select the MySubaru icon on the home screen and choose "Make an Appointment" to get started.

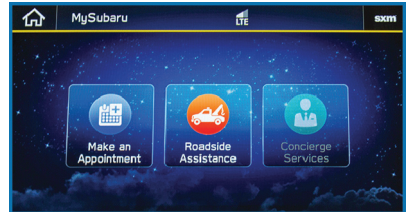

MAPS (if equipped)

MAPS OVERVIEW

Your new SUBARU STARLINK® comes equipped with an integrated navigation system, powered by TomTom. We hope you enjoy the state-of-the-art navigation technology and optimized mapping routes to guide you on safer, better, and more enjoyable journeys.

With your integrated navigation system, you can find destinations by address or search by points of interest, as well as save destinations in the system as favorites. You can also customize route options and settings and find the nearest gas station along your route with the touch of a button.

 For more information and step by step directions on using your navigation system, please refer to page 122 or the STARLINK® Owner's Manual.

CREATING HOME AND WORK PROFILES

Creating a driver profile allows you to save your home address and work address in the navigation system for ease of use.



 For step by step instructions on creating a driver profile, please refer to page 62.

STARLINK SAFETY AND SECURITY

SAFETY AND SECURITY OVERVIEW

STARLINK® Safety and Security services* are designed to help in your time of need. These include Advanced Automatic Collision Notification, SOS Emergency Assistance, Enhanced Roadside Assistance, Stolen Vehicle Recovery, the added convenience of Remote Engine Start with Climate Control, and so much more.



With the SUBARU STARLINK® system integrated into your vehicle, advanced safety and security technology is just a button press away. The SUBARU STARLINK® experience includes in-vehicle call center support, maintenance and diagnostic alerts as well as remote services that keep you connected to your Subaru vehicle.

Located in the overhead console of most Subaru vehicles are the red SOS  and blue i-button . Both buttons link you to the SUBARU STARLINK® call centers that are there to support you 24 hours a day, 7 days a week.

The SOS button  is for SOS Emergency Assistance.

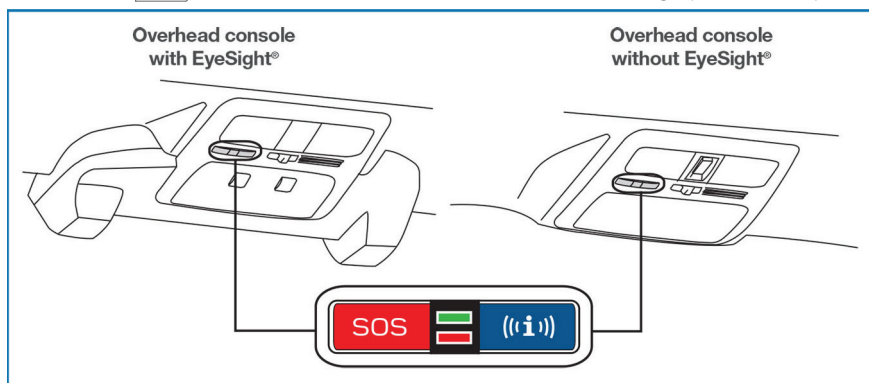
The i-button  is for Enhanced Roadside Assistance or Concierge (if subscribed).



- Press the SOS button  for SOS Emergency Assistance.*
- Press the i-button  for Enhanced Roadside Assistance* or Concierge* (if subscribed).*

STARLINK SAFETY AND SECURITY

- To cancel a SOS Emergency Assistance, Enhanced Roadside Assistance or a Concierge call, press and hold the same button for approximately two seconds or select the “End Call” button if displayed on the Touchscreen.

Head to www.Subaru.com/STARLINK to see all the SUBARU STARLINK[®] subscription services and packages.

- * Access to STARLINK[®] Safety and Security services requires an active STARLINK[®] subscription. Remote Engine Start available on keyless access with push-button start vehicles. Remote Engine Start with Climate Control available on vehicles with keyless access with push-button start and automatic climate control. Not available on vehicles with manual transmission.



Scan to learn more
about **SUBARU**
STARLINK.

ENROLLMENT

To enroll in SUBARU STARLINK[®] and access remote services, a MySubaru account is required. MySubaru is the Subaru owner website that allows you to access vehicle remote services, user preferences, diagnostic alerts and other useful features enabled by your STARLINK[®] Safety Plus, STARLINK[®] Security Plus and STARLINK[®] Concierge subscription.

Your retailer may have created an account for you during the delivery process. However, you can also create a MySubaru account on www.mysubaru.com.

Enrollment in SUBARU STARLINK[®] can be done online at MySubaru.com, through the MySubaru Mobile App, at your Subaru retailer or by calling a STARLINK[®] Customer Care Representative at:1-855-753-2495

NOTE: Please have your Vehicle Identification Number (VIN) available, as you will need it to complete this step. After the enrollment process, you will learn more about the features in detail at MySubaru.com.

STARLINK SAFETY AND SECURITY

MYSUBARU INTEGRATION

The connection between you and your Subaru has never been simpler, and the MySubaru website (MySubaru.com) and MySubaru Mobile Application are the best ways to stay in touch with your Subaru vehicle. From MySubaru, you can access the following information and STARLINK® Safety and Security services*:

- Remote Services
- Vehicle Health
- Usage Reports
- Service Appointment Scheduler
- Vehicle Maintenance Schedules
- Destination to Vehicle
- Service History
- Support Resources

* Internet access is purchased separately through AT&T with monthly, per gigabyte, and unlimited data options available. Existing AT&T customers have the option to add an additional line to their AT&T Mobile Share plan. Available on select models.

SUBARU STARLINK® WI-FI HOTSPOT

SUBARU STARLINK® in-vehicle Wi-Fi Hotspot keeps you and your family connected using AT&T's 4G LTE nationwide cellular network. Whether watching movies, playing games or even listening to music, your family won't miss a beat with SUBARU STARLINK® in-vehicle Wi-Fi Hotspot. Set up is quick and easy.

 For more information on a subscription and step by step enrollment instructions, please refer to page 121 or visit: <https://www.att.com/plans/connected-car/subaru.html>



Scan to learn
more about **AT&T**
Wi-Fi Hotspot

SETTINGS AND UPDATES

SETTINGS AND UPDATES OVERVIEW

Many settings can be customized for different features in your Subaru. In this section you will find examples and instructions for some of the settings you can tailor to fit your preferences, as well as ways to keep your system updated.

Connect to Home Wi-Fi

Connecting to your Wi-Fi network can allow you to update the software and maps. To connect to Wi-Fi, first go to the “Settings” screen, select “General”, and then select “Wi-Fi Settings”.

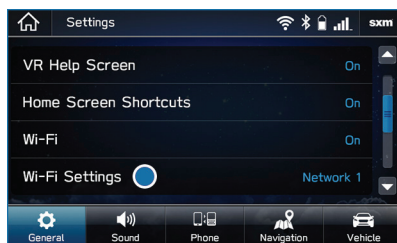

 For step by step instructions on connecting to Wi-Fi, please refer to page 120 or your STARLINK[®] Owner's Manual.

Performing Software Updates

Software updates provide enhancements to the system such as new features, added security, and upgraded functions.

You can ask your preferred Subaru retailer to update the system software. For the 8.0-inch Multimedia Plus and the 8.0-inch Multimedia Navigation systems, the system software can be updated via a Wi-Fi network or using the aha application on your smartphone (depending on your smartphone communication and transfer speed). The update process involves downloading and installing the software update.

NOTE: System functionality will be restricted during installation.

 For step-by-step instructions and more information, please refer to page 130 or your STARLINK[®] Owner's Manual.

SETTINGS AND UPDATES

SOUND

To change the sound settings, press the "Home" button, then select "Settings", and then select "Sound". Choose the setting you want to change.

| SETTING | FUNCTION |
|-----------------------|---|
| EQ and Sound Position | Select to set sound settings. |
| Entertainment Volume | Select to set audio volume. |
| Aux Volume Gain | Select to set AUX volume gain. |
| Microphone Volume | Select to adjust the mic sensitivity. This adjusts the speaker's voice during hands-free communication. |
| Navigation Volume | Select to set the navigation prompt volume. (Navigation-equipped vehicles only). |
| Phone Volume | Select to adjust the default volume of the other party's voice. |
| Ringtone Volume | Select to adjust the ringtone volume. |
| Speech/VR Volume | Select to set the voice recognition prompts volume. |
| Alert Sounds | Select to turn the Alert Sound on/off for traffic, weather, or SXM game information updates. |
| Beep Sounds | Select to turn the sound beeps on/off. |
| Speed Volume | Select to set the speed volume. The system adjusts to the optimum volume and tone quality according to vehicle speed to compensate for increased vehicle noise. |

PHONE

This system supports Bluetooth[®], a wireless data system. The hands-free system lets you make and receive calls without taking your hands off the steering wheel.

In the sound settings menu, you can adjust the microphone, ringtone, and phone volume.

On the Home Screen, select "Settings", then select the "Phone" menu to manage connected devices and access other phone settings.

SETTINGS AND UPDATES

MAPS/NAVIGATION

There are many programmable map/navigation features that can be customized. These settings are located under the "Settings" menu and then "Navigation". Listed in the table below are some common settings you can customize for your convenience.

| SETTING | FUNCTION |
|-----------------------------|--|
| Route Setting | Allows you to select Fastest, Shortest or Economic. |
| Avoid | Allows you to avoid things like highways, tolls, ferries, carpool lanes and unpaved roads. |
| Map Display | Allows you to change the brightness by selecting auto, day or night. |
| Save as Home | Allows you to input your home address. |
| Save as Work | Allows you to input your work address. |
| POI Icons | Allows you to turn the icons on/off. |
| Arrival Time | Allows you to select either 12 hour time or 24 hour (military) time. |
| Auto Zoom | Allows you to turn on/off. |
| Rest Stop Guidance Function | Allows you to turn on/off. |
| Low Fuel Warning | Allows you to turn on/off. |

Checking for Map Updates

You can update the maps to the latest information. The maps should be checked and updated regularly for the best possible navigation experience.

At www.subaru-maps.com, you can update the entire USA map at once via USB. The maps can also be updated over the air. When updating over the air, you can update eight regions at a time. This allows you to update your home state without having to download the entire map program for the United States. This option is great if you normally stay in your home state and/or surrounding states.

Updating Maps Over-the-Air

To update your maps over the air, first Connect to a Wi-Fi network (see page 120). Map updates can be found by selecting "Settings", then "Navigation" on the Touchscreen.

 For more step by step directions for updating your maps through Wi-Fi, please refer to page 128.

SETTINGS AND UPDATES

Updating Maps Using Your PC/MAC

Maps can also be updated using a USB memory device, which will allow the entire map program to be updated at one time. This is a great option if you are going to take a cross-country trip and your maps have not been updated in a while.

To update the map using a USB memory device, start by going to www.subaru-maps.com



Scan to learn
more about
Map Updates

SETTINGS AND UPDATES

CLOCK

The clock can be set manually or automatically. When set to “Auto”, the clock automatically adjusts when a Bluetooth® connected phone is paired (vehicles without navigation), or through the GPS signal (vehicles with navigation system).

Manually

Use the STARLINK® Touchscreen to set the clock:

- 1 Press the “Home” button.
- 2 Select “Settings”.
- 3 Select “Vehicle”.
- 4 Select “Time/Date”.



- 5 Select “Mode”.

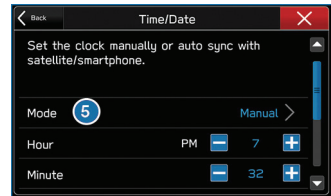

- 6 Select “Manual”.

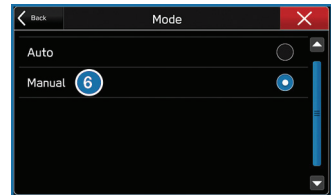

SETTINGS AND UPDATES

- 7 Now adjust the time and date using the “+” and “-” buttons. Select the check mark when finished.

For black-and-white Multi-Function Display (MFD), use the “+” and “-” buttons next to the clock.

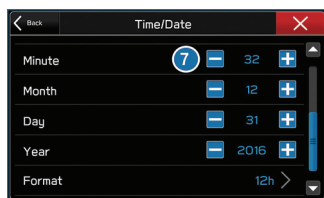

Automatically

To set the clock automatically, the “Auto” mode must be selected in the clock adjustment setting. To set the clock:

- 1 Press the “Home” button.
- 2 Select “Settings”.
- 3 Select “Vehicle”.
- 4 Select “Time/Date”.



- 5 Select “Mode”.

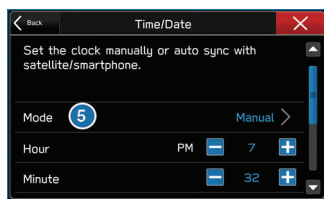

- 6 Select “Auto”. Press the “Home” button when finished.

The clock automatically adjusts as follows:

- Systems with Navigation: Automatically adjusts the clock when a GPS signal is available.
- Systems without Navigation: Automatically adjusts the clock when a phone is paired and connected via Bluetooth®. “Phonebook Download” must be enabled in the Phone Settings.

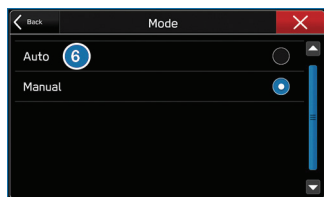

i For step-by-step procedures to pair a phone to the SUBARU STARLINK® Touchscreen, see page 108 for Android devices or page 112 for Apple devices.

EYESIGHT

EYESIGHT® OVERVIEW

Your Subaru features a variety of safety systems that are the culmination of everything Subaru Engineers know about safety. These systems are referred to as “Driver Assist Technologies” and add confidence to every trip you and your passengers take. Working together, these systems provide enhanced awareness, safety, and convenience in front, to the sides, and behind your Subaru. Subaru Driver Assist Technologies include:

- EyeSight® Driver Assist Technology
- Rear-Vision Camera
- Pre-Collision Braking
- Blind-Spot Detection (BSD)
- Rear Cross-Traffic Alert (RCTA)
- Reverse Automatic Braking (RAB)
- High Beam Assist (HBA)
- Lane Departure Prevention
- Steering Responsive Headlights (SRH)

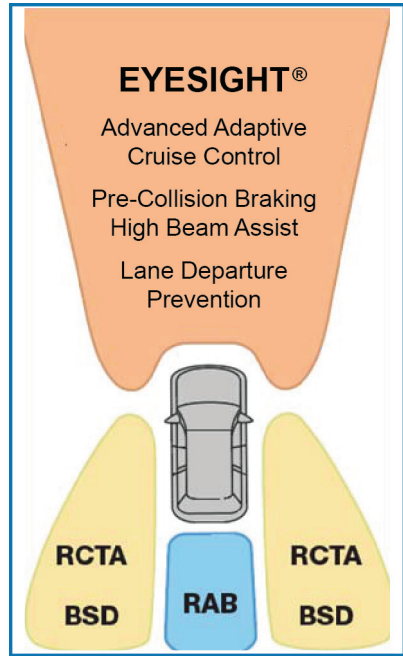

OPERATION

EyeSight® is a driver assist technology that uses dual color cameras to serve as an extra pair of eyes on the road ahead to identify vehicles in front, pedestrians, traffic lanes, or other objects. If need be, the EyeSight® system can apply the brakes and/or reduce engine power to help avoid or reduce the severity of a collision. During these events, the system will provide audible and visual alerts to assist you in making decisions.

Since the characteristics and limitations of the EyeSight® color cameras are similar to human eyes, it is important that the cameras, windshield, and area in front of the cameras are treated with special care. Please refer to “Care and Limitations” on page 101 for more details.



EyeSight Cameras (inside)



EyeSight Cameras (outside)

FUNCTIONS

The EyeSight® system features several distinct functions designed to provide extra awareness, improve safety, reduce fatigue, and add peace of mind every time you drive your Subaru. EyeSight® functions include:

- Pre-Collision Braking (PCB)
- Pre-Collision Brake Assist
- Pre-Collision Throttle Management
- Lane Departure Warning (LDW)
- Lane Sway Warning
- Lane Departure Prevention
- Advanced Adaptive Cruise Control
 - Advanced Adaptive Cruise Control (AACC)
 - Lane Centering
- Conventional Cruise Control
- Lead Vehicle Start Alert

Pre-Collision Braking

This function helps prevent or minimize a frontal collision with another vehicle, pedestrian, or other objects by providing visual and audible warnings. Warnings are displayed in the Combination Meter Display (CMD) with audible beeps. If you take no corrective action, the system automatically reduces engine power and applies the brakes with increasing force to help prevent or minimize the collision.

This system can be turned on or off by using the Pre-Collision Braking System OFF switch (see page 92).

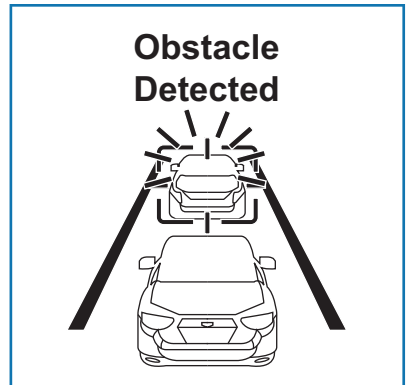

Pre-Collision Brake Assist

This function recognizes a possible collision with another vehicle, a pedestrian, or object in front while you are applying the brakes. If the system determines not enough force is applied, it can assist by applying additional pressure to the braking system to decrease stopping distance.

This system can be turned on or off by using the Pre-Collision Braking System OFF switch (see page 92).

EYESIGHT

Pre-Collision Throttle Management

This function is designed to help prevent you from unintentionally accelerating into a stopped vehicle or other obstacle by reducing engine power. Warnings are displayed in the Combination Meter Display (CMD) with audible beeps.

Pre-Collision Throttle Management is helpful when:

- You unintentionally place the select lever in the “D” position instead of the “R” position and start to accelerate toward a parked car, wall or parking structure.
- While you are at a stop, the vehicle ahead of you accelerates, but then suddenly slows down or stops as you begin to accelerate.

This system can be turned on or off by using the Pre-Collision Braking System OFF switch (see page 92).

Lane Departure Warning

This function provides audible and visual warnings if you are about to depart your lane of travel. Using the EyeSight® camera, the Lane Departure Warning function identifies lane markings when traveling at speeds of approximately 30 mph or greater. These warnings are displayed in the Combination Meter Display (CMD) with audible beeps. Lane Departure Warning does not provide any corrective actions.

You can turn this system on or off by using the Lane Departure Warning OFF switch (see page 92).

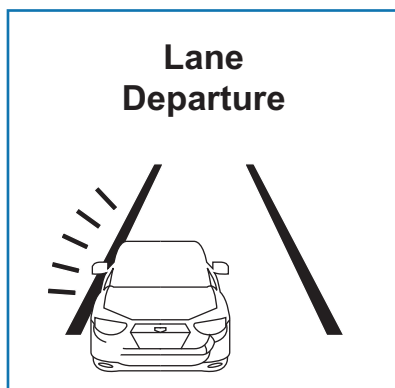

Lane Sway Warning

This function detects repetitive or unusual side-to-side vehicle movement within a lane of travel that may indicate a drowsy or inattentive driver. Using the EyeSight® camera, the Lane Sway Warning function identifies lane markings when traveling at speeds of approximately 37 mph or greater. Warnings are displayed in the Combination Meter Display (CMD) with audible beeps. Lane Sway Warning does not provide any corrective actions.

You can turn this system on or off by using the Lane Departure Warning OFF switch (see page 92).



Lane Departure Prevention

This function provides steering assistance to keep you in the lane of travel when driving on expressways, freeways, and interstate highways at approximately 37 mph or greater. Lane Departure Prevention uses the EyeSight® camera to identify lane markings and assists steering operation to help prevent lane departure.

This function is turned on or off using the Lane Keep Assist button on the right side of the steering wheel. Once the system is turned on, a white Lane Keep Assist icon will be displayed on the Combination Meter Display (CMD). Lane marking graphics on the CMD

change to white to indicate that the right and/or left lane markings have been successfully identified by the EyeSight® camera. If the vehicle is about to depart the driving lane, the system assists steering by gently guiding the vehicle back into your lane. When the system is actively providing assistance, the Lane Keep Assist icon in the CMD will change from white to green.

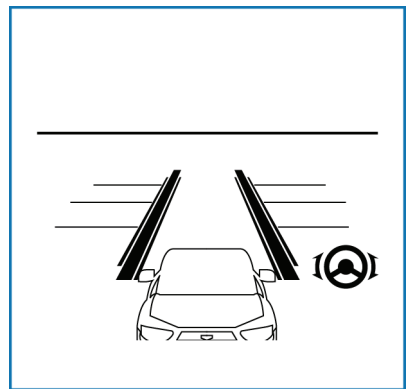

EYESIGHT

Advanced Adaptive Cruise Control with Lane Centering

Advanced Adaptive Cruise Control is a driving support system intended to reduce the burden on you when driving on an expressway (including during congestion and when driving at high speed). Advanced Adaptive Cruise Control and Lane Centering work together to assist you by automatically controlling the accelerator, brake, and steering.

Advanced Adaptive Cruise Control

This system provides cruise control with the ability to keep a safe distance from the car in front of you. Using the EyeSight® camera, the Advanced Adaptive Cruise Control function identifies vehicles in front of you in the same lane, and your vehicle follows the vehicle in front (up to the maximum of your set speed). While following, your vehicle will automatically maintain a following distance that corresponds to the speed of the vehicle in front. The vehicle is capable of being controlled at a speed between 0 mph and approximately 90 mph.

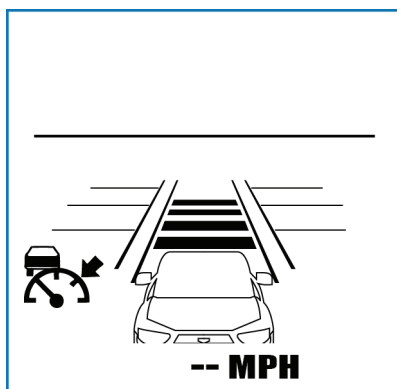

You can turn the Advanced Adaptive Cruise Control on or off using the Adaptive Cruise Control On/Off button on the right side of the steering wheel (see page 91). Once the system is turned on, a white Adaptive Cruise Control icon will be displayed on the Combination Meter Display (CMD). When all the operational conditions are met, "READY" appears underneath the Adaptive Cruise Control icon.

To set Advanced Adaptive Cruise Control, push down the "SET/-" switch on the right side of the steering wheel. The CMD will indicate a target speed and the icon will turn green. This speed can be adjusted up or down using the "RES/SET" switch (see page 91).

When a vehicle in front of you is identified, a Lead Vehicle icon will be displayed on the Combination Meter Display (CMD) and/or Multi-Function Display (MFD). You can change the desired following distance from the lead vehicle by pressing the "Increase Distance" or "Decrease Distance" buttons (see page 91).

Lane Centering

The stereo camera detects lane markings (including Botts' dots) of the lane and the lead vehicle, and the system assists the steering operation by working with the electric power steering to help keep your vehicle in its lane when driving on expressways, freeways and interstate highways.

This function can be used by pressing the Lane Keep Assist switch when the Advanced Adaptive Cruise Control is activated. When driving at speeds of 0 mph to approximately 90 mph, the system detects the lane markings and/or the lead vehicle and assists you with steering in order to keep the vehicle close to the center of the lane.

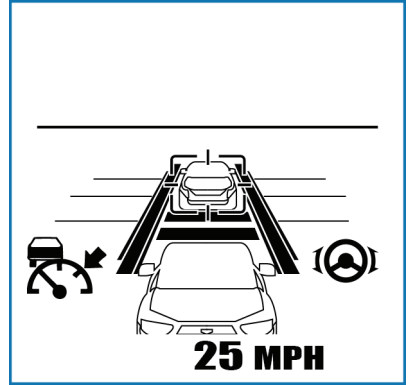

Conventional Cruise Control

Conventional Cruise Control maintains a constant traveling speed you set, but it does not adapt to the other vehicles in front of you. To activate Conventional Cruise Control, press the Adaptive Cruise Control On/Off button to set Advanced Adaptive Cruise Control into standby status. Then, with Advanced Adaptive Cruise Control in standby status, press and hold the "Increase Distance" or "Decrease Distance" button on the steering wheel for approximately two seconds.

The Cruise Control indicator on the Combination Meter Display (CMD) will change from the Adaptive Cruise Control icon to the Conventional Cruise Control icon. Use the accelerator to reach the desired speed, then use the RES +/-SET - switch to set the vehicle speed.

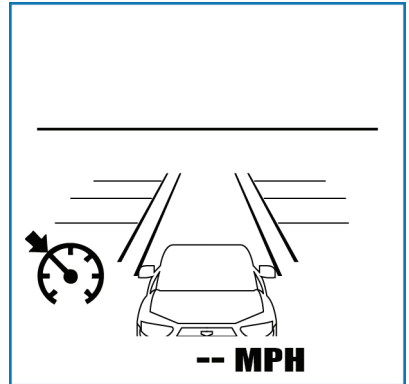

EYESIGHT

Lead Vehicle Start Alert

This function will provide a visual and audible alert when a stopped vehicle in front of you begins to move, and your vehicle remains stationary. Warnings are displayed in the Combination Meter Display (CMD) with audible beeps. Lead Vehicle Start Alert is helpful in situations where you may become temporarily distracted at a traffic light, and the vehicle ahead begins to move.

This function can be customized. To change this setting, use the steering wheel mounted “i/SET” switches to access the EyeSight® settings menu on the CMD.

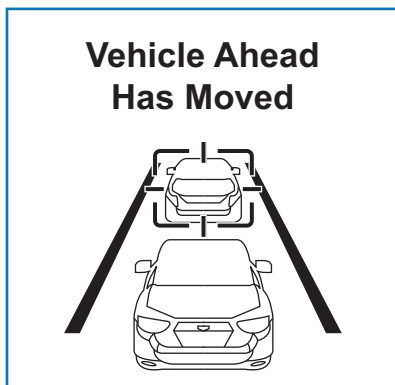

STEERING WHEEL CONTROLS

Advanced Adaptive Cruise Control

- 1 **Adaptive Cruise Control On/Off:** Press to turn Advanced Adaptive Cruise Control on or off.
- 2 **Lane Keep Assist:** Press to turn on or off Lane Centering or Lane Departure Prevention.
- 3 **Increase Distance:** Press to increase the following distance setting while using Advanced Adaptive Cruise Control. Press and hold to change to Conventional Cruise Control.
- 4 **Decrease Distance:** Press to decrease the following distance setting while using Advanced Adaptive Cruise Control. Press and hold to change to Conventional Cruise Control.
- 5 **Resume (RES)/Increase Speed and Set (SET)/Decrease Speed:** Press the switch down to set an initial target speed. Once set, press up or down to adjust the target speed.
 - **Adjust by 5 mph:**
 - Briefly press the switch up to increase the target speed by 5 mph.
 - Briefly press the switch down to decrease the target speed by 5 mph.
 - **Adjust by 1 mph:**
 - Press and hold the switch up to increase the target speed in 1 mph increments.
 - Press and hold the switch down to decrease the target speed in 1 mph increments.
 - The Cruise Control Acceleration Characteristics can be adjusted to four different levels depending on your preference. The four levels are:
 - Lv. 1 Eco
 - Lv. 2 Comfort
 - Lv. 3 Standard
 - Lv. 4 Dynamic



Advanced Adaptive Cruise Control Switches

To change this setting, use the steering wheel mounted "i/SET" switches to access the EyeSight® settings menu on the Combination Meter Display (CMD).

EYESIGHT

Customizing EyeSight® Settings

The EyeSight® system features customization of certain preferences and warnings. Use the steering wheel mounted “i/Set” and arrow switches to navigate through the Combination Meter Display (CMD) to adjust settings such as:

- Warning Volume: Min/Mid/Max
- Cruise Control Acceleration Characteristics: Eco/Comfort/ Standard/Dynamic

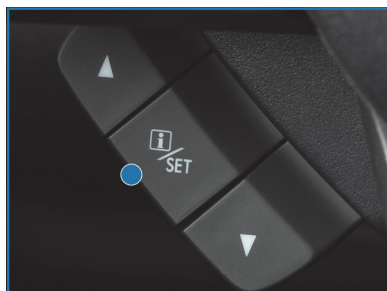

i/Set and Arrow Switches

LANE DEPARTURE WARNING AND PRE-COLLISION BRAKING SYSTEM OFF SWITCHES

Lane Departure Warning OFF Switch

Press and hold this switch on the overhead console for two seconds to turn off the Lane Departure Warning and Lane Sway Warning functions. Press and hold the switch again for two seconds to turn the functions on.

When these functions are off, a yellow Lane Departure Warning OFF indicator will be illuminated in the Combination Meter. It may be helpful to turn these functions off when lane markings on the road are inconsistent.



Pre-Collision Braking OFF Switch

Press and hold this switch on the overhead console for two seconds to turn off the Pre-Collision Braking, Pre-Collision Brake Assist, and Pre-Collision Throttle Management functions. Press and hold the switch again for two seconds to turn the functions on.

When these functions are off, a yellow Pre-Collision Braking OFF indicator illuminates in the Combination Meter. It may be helpful to turn these functions off when using a drive-through carwash.



DRIVER ASSIST TECHNOLOGIES

REAR-VISION CAMERA

This function provides a clear view of the area behind the vehicle to help avoid obstacles. Using a wide-angle camera mounted on the rear of the vehicle, an image is automatically displayed on the multimedia screen when you place the select lever in the “R” position. The displayed image features a centerline indicator, colored distance markers, and dynamic guidelines that move as the steering wheel is turned.



Rear-vision Camera Washer

To help keep your vision clear, your Subaru comes equipped with a Rear-vision Camera Washer. The Rear-vision Camera Washer is activated whenever the washer for the rear window is used. Rotate the end of the window wiper lever down from the “OFF” position, or up from the continuous operation position, to clean both the rear window and the Rear Vision Camera.



 For more information, please refer to your Owner's Manual.

BLIND-SPOT DETECTION (BSD)/ REAR CROSS-TRAFFIC ALERT (RCTA) (if equipped)

This system uses radar sensors mounted behind the rear bumper on the left and right sides that warn you if another vehicle is sensed in your blind spots. These functions provide additional awareness when changing lanes or driving in reverse.

Blind-Spot Detection (BSD)

This function senses if a vehicle is in your blind spot and provides a visual warning (yellow light) in the corresponding side mirror frame.



Lane Change Assist (LCA)

Lane Change Assist (LCA) works with Blind Spot Detection to provide an additional level of warning if you attempt to change lanes with a vehicle in your blind spot. LCA will rapidly flash the corresponding side mirror indicator if you operate your turn signal when a vehicle is sensed in your blind spot.

DRIVER ASSIST TECHNOLOGIES

Rear Cross-Traffic Alert (RCTA)

This function detects a vehicle approaching from either side as you reverse and provides audible and visual warnings. Warnings will appear in the upper corner of the Rear-View Camera display and side mirrors, and audible beeping will sound.



BSD/RCTA can be turned on or off by pressing the BSD/RCTA OFF switch in the instrument panel. When this function is off, a yellow BSD/RCTA OFF indicator will be displayed in Combination Meter.

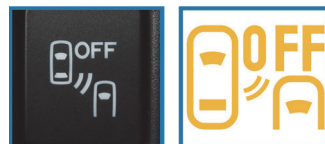

HIGH BEAM ASSIST (HBA)

This function uses the EyeSight® cameras to automatically switch the headlights between high and low beam settings when an oncoming vehicle is detected, enhancing safety for both you and other drivers on the road.



To activate High Beam Assist, set the headlight control switch to the "AUTO" position and push the headlight lever forward to the high beam position. The green HBA indicator will illuminate on the Combination Meter Display (CMD). When vehicle speed is above approximately 20 mph, HBA will automatically switch between high and low beams. When the high beams are activated, the blue high beam indicator will be displayed in the Combination Meter.

STEERING RESPONSIVE HEADLIGHTS (SRH)

The Steering Responsive Headlights (SRH) system aims the headlight beams in the direction you are steering, improving visibility at corners and intersections when driving at night. Although the system is normally on, you can turn the system off using the SRH OFF switch located on the lower left console.

DRIVER ASSIST TECHNOLOGIES

REVERSE AUTOMATIC BRAKING (RAB) (if equipped)

This system uses four rear bumper mounted sonar sensors to detect objects when moving between 1 and 9 mph in reverse. RAB uses the Rear-Vision Camera image to display colored proximity alerts when an object is detected. As an object becomes closer to the rear of your vehicle, audible beeps provide additional awareness in three progressive levels. If RAB determines that a collision with an object is possible, the system can automatically apply the brakes to help prevent or minimize the impact.

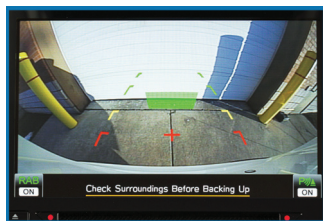

In some cases, such as connecting a trailer, it may be helpful to temporarily turn the system off. RAB can be turned off using the Touchscreen buttons on the lower corners when the select lever is in the "R" position.

Select and hold the "RAB ON" button in the lower part of the Touchscreen until it changes to "RAB OFF" to disable the automatic braking functions of the RAB system.



Select and hold the "P))) ON" button in the lower part of the Touchscreen until it changes to "P))) OFF" to disable the audible beeping of the RAB system.



DRIVERFOCUS DISTRACTION MITIGATION SYSTEM

DRIVERFOCUS[®] OVERVIEW (if equipped)

Your Subaru features DriverFocus[®], a state-of-the-art system that helps reduce distracted driving for both new and experienced drivers.

Working with our award-winning EyeSight[®] Driver Assist Technology, DriverFocus[®] is like having an attentive co-pilot along for the ride, available to give a helpful alert if a driver becomes distracted or drowsy. For added convenience, DriverFocus[®] can also recognize up to five drivers and remember their preferences, such as seat position, climate settings, and outside mirror positions.

 For more information, please refer to “Driver Monitoring System” in your Owner’s Manual.

DRIVERFOCUS[®] COMPONENTS

Camera

DriverFocus[®] uses a near-infrared camera to focus on the driver’s eyes and head positions.



DRIVERFOCUS DISTRACTION MITIGATION SYSTEM

Multi Function Display (MFD)

The MFD is used to register and delete users. Navigate the MFD screens using the “INFO” and “i/SET” switches on the steering wheel.



INFO SWITCH

Press the INFO switch to cycle through useful information in the Multi-Function Display (MFD). Navigate to the “Settings” Menu, then “Driver Monitoring System” to register drivers and change other DriverFocus® settings.



i/SET Switch

Once in the Multi-Function Display settings, pulling the up and down arrow switches will navigate through the settings menus. Pull the “i/SET” switch to confirm a selection.

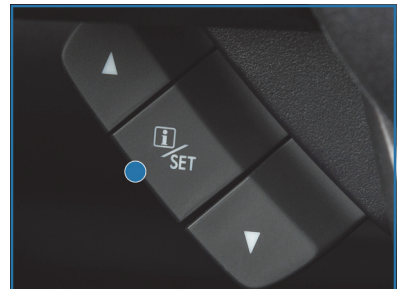

i/Set and Arrow Switches





DRIVERFOCUS DISTRACTION MITIGATION SYSTEM

Combination Meter Display (CMD)

The CMD provides audible signals, visual alerts, and reminders in the event you become drowsy or distracted. DriverFocus® status is also displayed in the CMD. The Status Icons Chart below explains the status icons.



CMD

| Status Icon | Indication |
|---|---|
|  | DriverFocus is actively operating |
|  | OFF (Switch was pressed) |
|  | Temporary Stop (See Owner's Manual) |
|  | Malfunction (Contact your Subaru Retailer) |

Status Icons Chart

DRIVERFOCUS DISTRACTION MITIGATION SYSTEM

DROWSY/INATTENTIVE WARNINGS

DriverFocus® detects when the driver is possibly not paying attention or is becoming drowsy while driving. It works whether you are a registered user or not. The system does not provide alerts when the turn signals are operating or when the select lever is in the “R” position.

When the system perceives the driver is not paying attention, the “Keep Eyes on Road” warning will appear in the CMD along with three rapid beeps.

When the system perceives drowsy driving, various warnings will appear in the CMD and/or MFD, along with beeps.

Press the Driver Monitoring System OFF button on the instrument panel to turn the system off. Press it again to turn the system back on again.



DRIVER PROFILE/CONVENIENCE SETTINGS

You can take advantage of convenience settings by becoming a registered driver.

Preferences such as seat and side mirror memory settings, as well as some features in the MFD and climate control, are uniquely linked to you.

Registering a Driver

1. With the ignition on, use the INFO button on the steering wheel to navigate to the “Settings” menu in the MFD. Press and hold the INFO button to enter the menu.
 2. Use the i/SET switches to navigate to the “Driver Monitoring System” menu.
 3. Select “Register User” to add a new driver. Up to five drivers can be registered.
 4. Select the position number you want to store to. Adjust the seat and side mirror positions before selecting “Set”.
 5. Face forward until you hear a beep.
- NOTE: The system does not save images, audio or video.
6. Use the i/SET switch to enter your name and choose from an available icon.
 7. Select “Set” to finish registration.

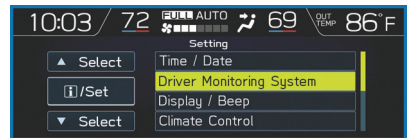

DRIVERFOCUS DISTRACTION MITIGATION SYSTEM

Recognizing a Driver

DriverFocus® will scan and recognize you as soon as you enter the vehicle. The MFD will display a welcome screen with your user name and personal icon. The vehicle will also recall your user settings, such as driver seat and side mirror positions.

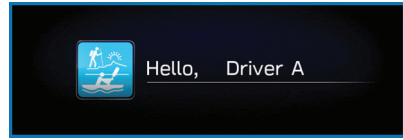

Deleting a Driver

1. With the ignition on, use the INFO button on the steering wheel to navigate to the "Settings" menu in the MFD.
2. Press and hold the INFO button to enter the settings menu.
3. Use the i/SET switches to navigate to the "Driver Monitoring System" menu.
4. Select "Delete User".
5. Select the driver you want to delete and select "Yes".

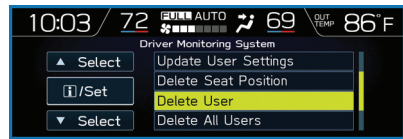

DRIVER MONITORING SYSTEM OFF

Press the switch on the lower left instrument panel to turn the DriverFocus® system off. Press the switch again to turn the system back on.



CARE AND LIMITATIONS

STEREO CAMERA PRECAUTIONS

Your EyeSight® stereo cameras are precision components that must be kept free from obstruction and contamination, such as fingerprints or cleaning solutions. When the system detects that the stereo camera lenses are impaired, a malfunction indicator will be displayed and EyeSight® functions will not be available.

When you are in the vicinity of the EyeSight® stereo cameras, always observe the following precautions:

- Do not touch or attempt to clean the EyeSight® camera lenses inside the vehicle. Extra caution should be used when cleaning the inside of the windshield. Over-spray from cleaning solutions may impair or even damage the camera lenses. Please inform others who may attempt to clean the windshield, such as car wash staff, of this precaution.
- Electronic Toll Collection devices, such as EZPass™, must be installed in an area that does not obstruct the stereo cameras' field of vision. See "Prohibited Area" on page 102.
- Adjust the rearview mirror so it does not obstruct the stereo cameras' field of vision.
- Do not install any interior rearview mirror accessories, such as a wide-type mirror or hanging objects. Only approved Genuine SUBARU accessories may be installed.

For more detailed information, please refer to your EyeSight® Owner's Manual.

WINDSHIELD GLASS AND DASHBOARD

Since the characteristics and limitations of the EyeSight® stereo cameras are similar to human eyes, it is important that the area in front of the cameras be kept free from dirt, scratches, cracks, fogging, or accessories mounted to the windshield, hood or dashboard. Visual impairments or reflections can affect EyeSight® system performance. Extra caution should be taken when cleaning the windshield to prevent over-spray from cleaning solutions.

The image in the following section outlines those areas that must be kept clean and free from obstruction. Please refer to the Owner's Manual for a complete listing of limitations.

FRONT VIEW

FORESTER

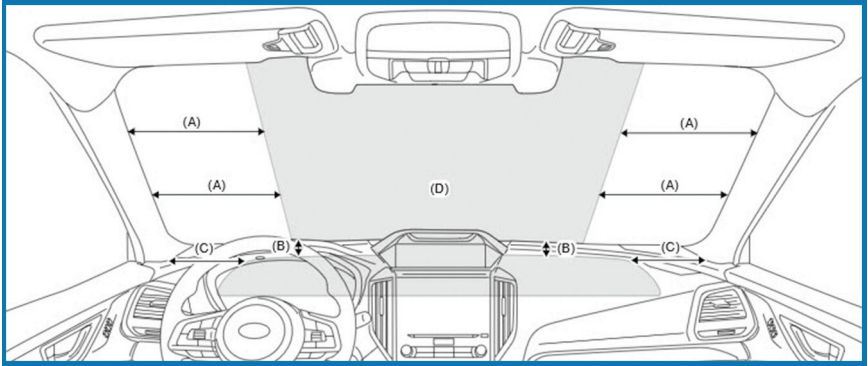

(A) 10.4 in (264.9 mm)
(B) 5.5 in (139 mm)

(C) 9.6 in (243 mm)
(D) Prohibited area (in gray)

EYESIGHT DISCLAIMER

EYESIGHT® DISCLAIMER

EyeSight® is a driver assist technology which may not operate optimally under all driving conditions. The driver is always responsible for safe and attentive driving. System effectiveness depends on many factors such as vehicle maintenance, weather and road conditions. See Owner's Manual for complete details on system operations and limitations.

The Pre-Collision Braking system is designed to provide automatic braking that either prevents a collision or reduces the severity of a frontal impact.

The Pre-Collision Throttle Management system is designed to reduce acceleration and minimize the severity of certain frontal impacts.

Advanced Adaptive Cruise Control and Brake Light Recognition are designed to assist the driver and are not substitutes for safe and attentive driving.

Lane Centering function operates only when used in conjunction with Advanced Adaptive Cruise Control.

Lane Departure Prevention operates only when the lane markings are visible, and system effectiveness depends on many factors.

Blind-Spot Detection, Lane Change Assist and Rear Cross Traffic Alert are systems designed to assist the driver by monitoring the rear and side areas of the vehicle during a lane change or reversing and are not a substitute for safe and attentive driving.

The Reverse Automatic Braking System is not a substitute for safe and attentive driving. System effectiveness depends on many factors, such as vehicle maintenance, weather and road conditions. Always exercise caution and use vehicle mirrors and the Rear-Vision Camera when backing up. See Owner's Manual for complete details on system operation and limitations.

The Driver Focus Distraction Mitigation System is a driver recognition technology designed to alert drivers if their attention to the road wavers or if the driver's face appears to turn away. The driver is always responsible for safe and attentive driving. System effectiveness may be affected by articles of clothing worn on the head or face. See Owner's Manual for complete details on system operation and limitations.

HOW TO APPENDIX

HOW TO OVERVIEW

This “How To” appendix provides detailed, step-by-step instructions to easily connect with features of your Forester.

If you need some help with these features or want to learn more, we are here to assist you:

Your Subaru Owner’s Manuals:

Located in the glovebox

Online Subaru Owner’s Resources:

www.subaru.com/owners

Subaru Customer Support:

www.subaru.com/customer-support

1-800-782-2783 (1-800-SUBARU3)



Scan to learn more
about **Owner's
Resources.**



Scan to learn more
about **Customer
Support.**

MEMORY HEIGHT (if equipped)

You can set where the rear gate stops when it opens. This is a great feature to limit the upward travel of the rear gate to ensure you can reach it or to prevent the rear gate from contacting a garage ceiling. To set the height, perform the following procedure with the ignition switch in the “LOCK/OFF” position:

- 1 Make sure the Memory Height Switch is the “OFF” position (the switch is raised and you can see a white line on the top).



Memory Height Button

- 2 Open the rear gate using the Power Rear Gate Button. Pause the rear gate when it reaches the desired height by pressing the Power Rear Gate Button on the rear gate, instrument panel, or key fob.



Power Rear Gate Button

HOW TO APPENDIX

- 3 Press the memory switch in the instrument panel to select the “ON” status (switch is depressed and you can no longer see the white line on top).



Memory Height Button

- 4 With the rear gate at the desired height, press and hold the Power Rear Gate Close Button on the inside edge of the rear gate. A chirp will sound and the hazard warning lights will flash to confirm the height is set.



Power Rear Gate Close Button

When the memory switch is in the “ON” status, the rear gate will stop at the set memory height when you use any of the Power Rear Gate buttons.

MEMORY DRIVER'S SEAT (if equipped)

You can set a seat position and retrieve it using the buttons on the driver's door or the access key fob.

To set a seat position with a button:

1. Make sure the select lever is in the "P" position, with the parking brake applied and the ignition in the "ON" position.
2. Adjust the seat to the desired position.
3. While holding the "SET" button, press and hold either button "1" or "2". A chirp sounds when the position is registered.



Memory Seat Buttons

To retrieve the seat position set with a button:

1. Turn the ignition switch to "ON".
2. Put the select lever in the "P" position and apply the parking brake. Then, press button "1" or "2".

To set a seat position with the access key fob:

1. Make sure the select lever is in the "P" position with the parking brake applied and the ignition "OFF".
2. Adjust the seat to the desired position.
3. While holding the "SET" button, press and hold the unlock button on the access key fob. A chirp sounds when the position is registered.

To retrieve the seat position set with the access key fob:

1. Hold the access key fob.
2. Unlock and open the driver's door.

HOW TO APPENDIX

BLUETOOTH® PAIRING

Pairing an Android Device

1. Start by selecting “Settings” on the Home screen.

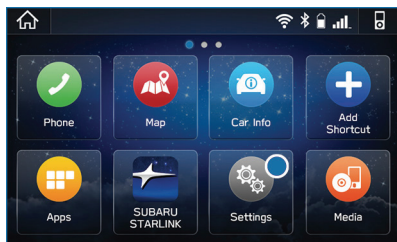

2. Select the Phone menu, then select “Add Device” / “Add Phone”.

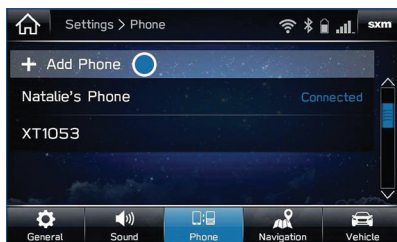

3. This screen will be displayed when pairing mode is in progress. The device name will most likely be Subaru BT, but be sure to make note of what name it is, so you can find it on your phone.

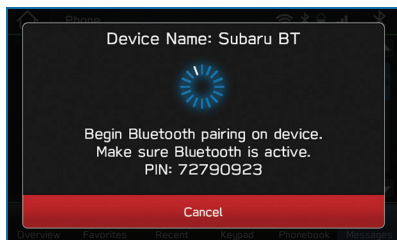

HOW TO APPENDIX

4. On your Android device, go to “Settings”. (It can be found under apps.) Then select “Connected Devices” or “Connections”.

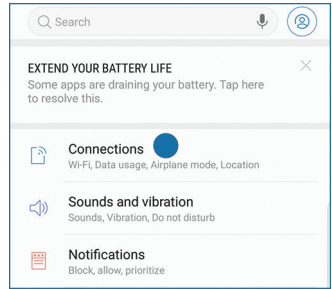
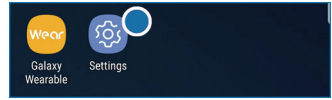

5. Now select “Bluetooth”. This will show a screen to “Pair New Device” or it will be showing the nearby devices to add. Select “Subaru BT” if shown on the list or “Pair New Device”.

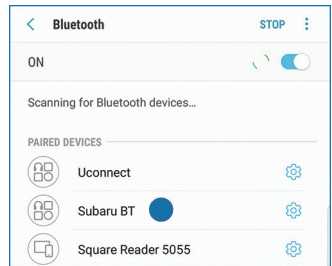
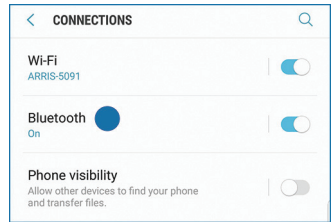

HOW TO APPENDIX

6. Now select "OK" to pair with Subaru BT and select "Confirm" on the Touchscreen if the PIN matches the phone.

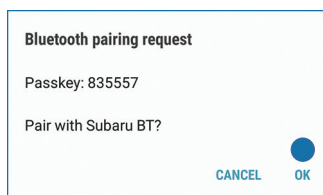

7. Make sure to allow access to your contacts and call history and select "Download" to download the phonebook contacts.

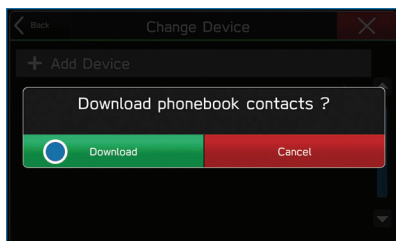
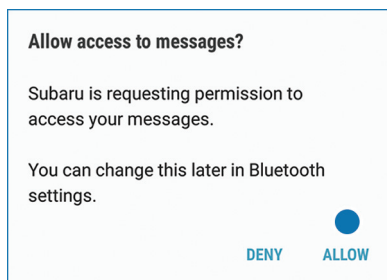

HOW TO APPENDIX

8. If your phonebook or messages are not appearing, press the “Phone” icon on the Home screen. Next, select “Change Device” in the Overview menu and ensure the “Phonebook Download” is enabled.

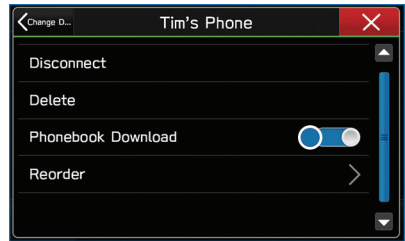

9. If you still cannot access your phonebook or messages, go back to your phone's Bluetooth® settings and select the gear icon next to your vehicle's device name and ensure all settings are enabled.

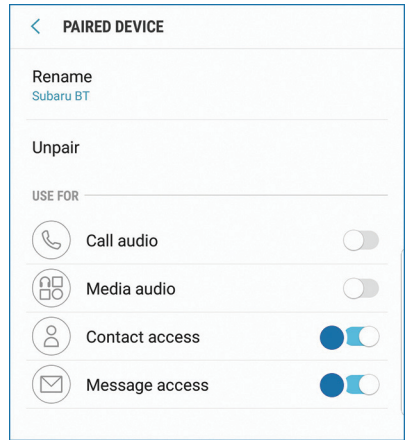

HOW TO APPENDIX

Pairing an iOS/Apple Device

1. Start by selecting “Settings” on the Home screen.

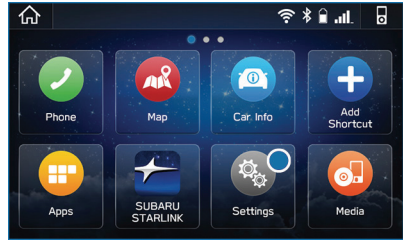

2. Go to the “Phone” screen and select “Add Device” / “Add Phone”.

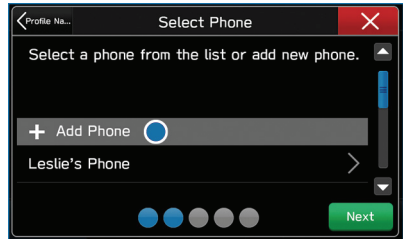

3. This screen will be displayed when pairing mode is in progress. The device name will most likely be Subaru BT, but be sure to make note of what name it is, so you can find it on your phone.

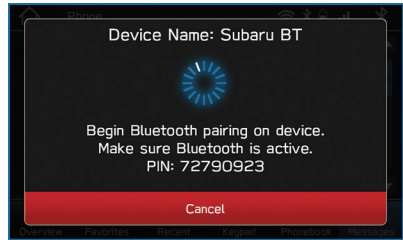

4. On your iOS/Apple device, select “Settings”. The location on the Home screen will vary.

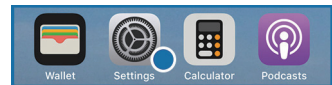

HOW TO APPENDIX

5. Select “Bluetooth”.

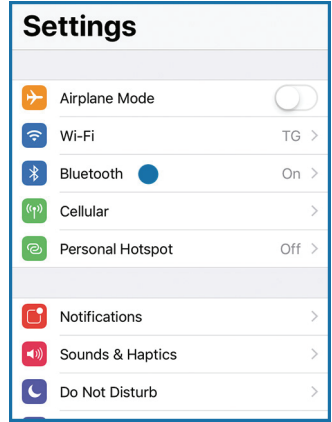

6. Now select the device name (usually “Subaru BT”) on the Touchscreen.

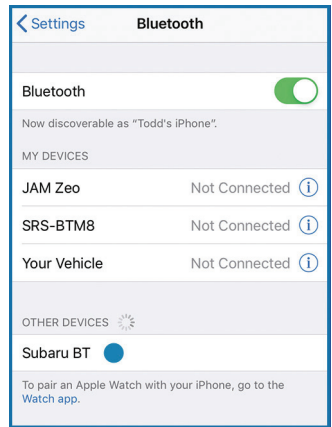

HOW TO APPENDIX

7. Verify your iOS/Apple device PIN is correct and select “Pair” on your phone and “Confirm” on the Touchscreen.

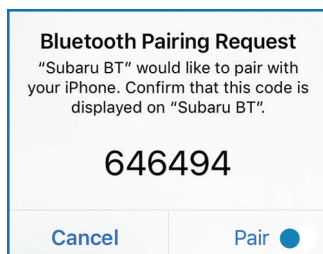

8. Select “Allow” on the “Allow Contacts and Favorites Sync?” screen, then select “Download” to download the phonebook contacts.

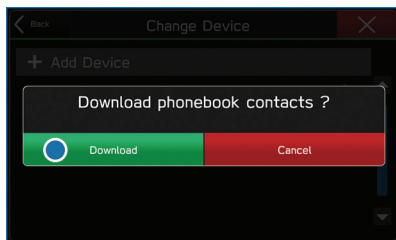
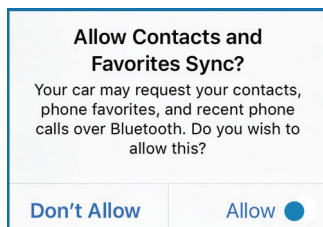

HOW TO APPENDIX

9. On your iOS/Apple device, SubaruBT should now be listed under “Bluetooth Settings”. Select the blue “i” next to the device name. Then ensure “Show Notifications” and “Sync Contacts” are enabled.

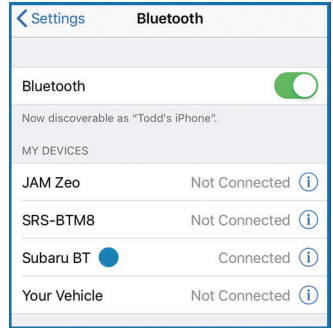

10. Your iOS/Apple device is now paired. It is recommended that you restart your Subaru to complete the process and ensure everything is fully synced.

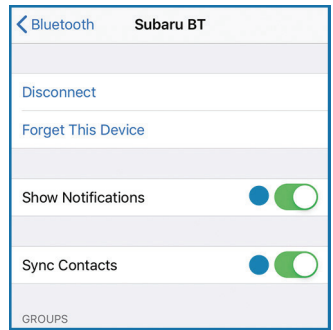

11. If your phonebook or messages are not appearing, press the “Phone” icon on the Home screen. Next, select “Change Device” in the Overview menu and ensure the “Phonebook Download” is enabled.

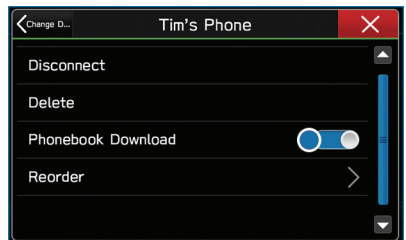
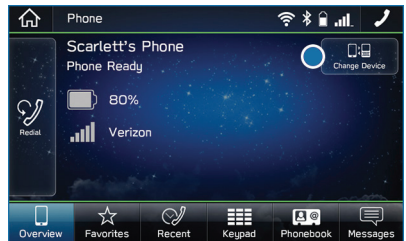

HOW TO APPENDIX

ANDROID AUTO™

Cables

Always use a high-quality OEM USB cable.

Ensure the Android phone is fully up to date. Also verify that the Android Auto app, along with all other apps that work with Android Auto, are up to date. Android Auto might not function properly if one of them is outdated or having an issue. The apps can be downloaded from the Play Store.

 For more information, visit: www.android.com/auto/



Scan to learn more about
Android Auto

Connecting an Android Phone

1. To set up Android Auto, first plug the Android phone into the USB port of the vehicle using a quality OEM cable. The first time you plug in, this message will appear. Select “Accept”. After that, select “Accept” to any other prompts that appear. Android Auto might also need to download before functioning on the vehicle; allow it to do so.

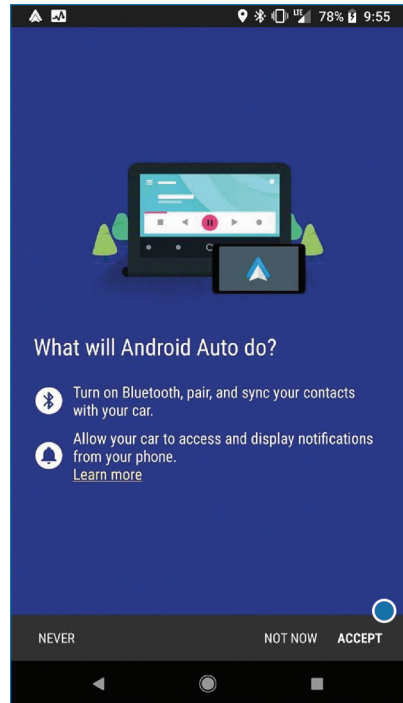

HOW TO APPENDIX

2. On the vehicle display screen, Android Auto should launch the first time. If not, select the Android Auto Icon on the display. Select “Show Me How” for a quick guide on using Android Auto, or select “Skip” if you want to start using the app right away.

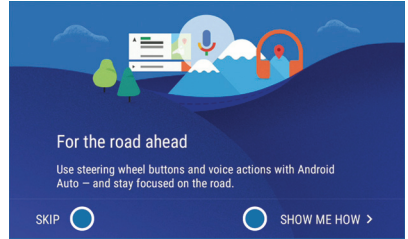

3. You will then be taken to the Home screen of the Android Auto app for your phone.

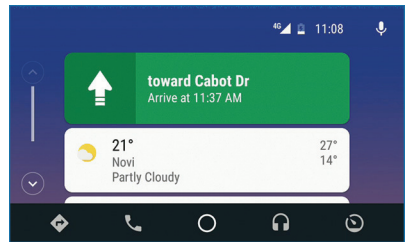
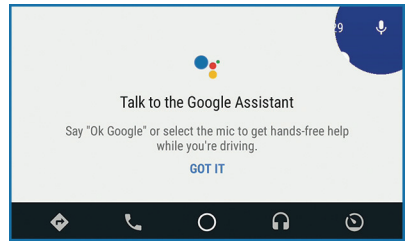

4. If Android Auto won't launch, open the Android Auto app on the phone, then select the top left menu button. Select “Settings”, then “Connected Cars”, and finally select the top right menu icon and choose “Forget all cars”.

If this does not work, uninstall the Android Auto app from the phone and reinstall from the Play Store.

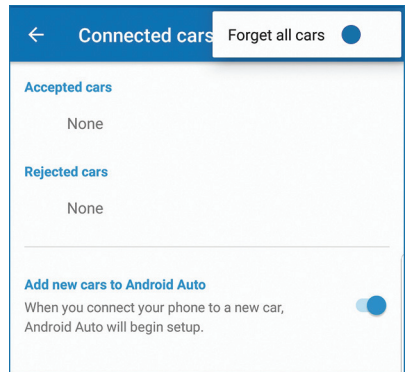

HOW TO APPENDIX

Compatible Models

Android Auto is available on Android phones. To see if your phone is compatible, please refer to the Android Auto website:

<https://www.android.com/phones/>



Scan to see if your phone is compatible with **Android Auto**

APPLE CARPLAY®

Cables

Apple CarPlay requires compatible iPhones to be connected via your Subaru's USB port. Cables must be an 8-Pin Lightning MFi Certified cable (made for iPod/iPhone). Look for the Works with Apple CarPlay or Made for iPod, iPhone, iPad icons when selecting a cable.

 For more information, visit: www.apple.com/ios/carplay/



Scan to learn more about **Apple CarPlay**

Connecting an iPhone

1. To set up Apple CarPlay, you will need to plug the iOS/Apple phone into the USB port of the vehicle. Make sure to use an MFi certified cable.
2. Select "Allow" on the iOS/Apple phone when prompted.

Allow CarPlay with "Impreza/XV" while phone is locked?

Your contacts and other information will appear on this car's display without unlocking your iPhone.

Not Now

Allow

3. Select Apple CarPlay on the vehicle screen. This will bring you to the home screen of your phone in Apple CarPlay.

Ensure the iOS/Apple phone is fully up to date. Also ensure all apps that work on Apple CarPlay are up to date. Apple CarPlay might not function correctly if one of the apps is outdated or having an issue. Apps can be updated in the App Store.

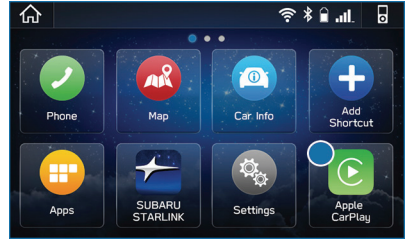

Compatible Models

For a list of all the Apple phones that are compatible with Apple CarPlay, visit: www.apple.com/ios/carplay/



Scan to learn
more about
Apple CarPlay

HOW TO APPENDIX

WI-FI

Connecting to a Wi-Fi Network

1. Display the General Settings screen by pressing the “Home” button, then select “Settings”. Make sure Wi-Fi is on.
2. Under the “General” tab, select “Wi-Fi Settings”.
3. Select the desired network. If the network is a secure network, a lock symbol appears on the right side of the screen. If you are connecting to a secure network, enter the password and select “Join”.
4. Select “Connect” to connect to the network or “Disconnect” to disconnect from the network. Selecting “Forget This Network” deletes the network.
5. Check that a confirmation message appears when the connection is complete. If an error message appears, follow the guidance on the screen to try again.

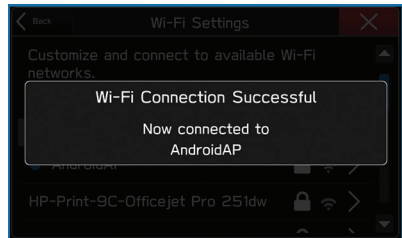
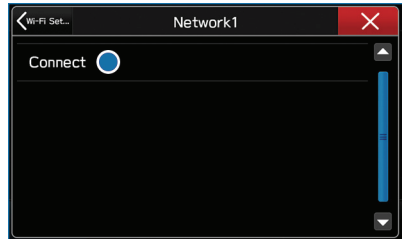
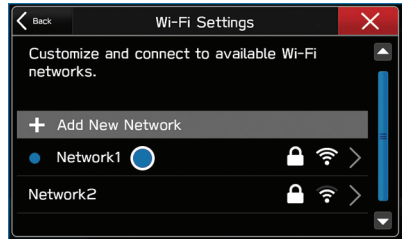
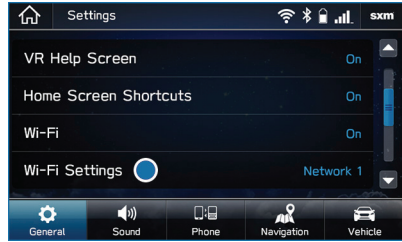

Wi-Fi Hotspot Subscription

Internet access is purchased separately through AT&T with monthly, per gigabyte, and unlimited data options available. Existing AT&T customers have the option to add an additional line to their AT&T Mobile Share plan. Available on select models.

Shortly after you take delivery of your new Subaru, you will receive an email from AT&T for a one month free trial and how to activate your free trial. To set up and enroll:

1. Select “Settings” on the Home screen.
2. Select “Wi-Fi Hotspot” to turn it on (if the Wi-Fi Hotspot is already on then proceed to the next step).
3. Select Wi-Fi Hotspot Settings to view or update the following settings:
 - Wi-Fi Network Name (SSID)
 - SSID Broadcast (Network ON / OFF)
 - Security Type (WPA / WPA2)
 - Password
 - Connected Devices (Maximum of 8 devices)

How to enroll:

1. Connect your tablet, smartphone or laptop to the SUBARU STARLINK® Wi-Fi Hotspot network listed in the settings menu and open your preferred web browser on the device connected.
2. Once the SUBARU STARLINK® Wi-Fi Hotspot homepage loads, follow the on-screen instructions to create a new account or to add your vehicle to an already existing AT&T Wireless account. You can also subscribe to the Wi-Fi Hotspot from the MySubaru website or Mobile App.

 You can also visit an AT&T store or their website for more information at:
<https://www.att.com/plans/connected-car/subaru.html>



Scan to learn
more about
AT&T plans

HOW TO APPENDIX

MAPS (if equipped)

Finding a Destination by Address

To search by address:

1. Start by pushing the “Map” button to display the map screen. Then, select “Menu”. Next select “Search for Destination Enter Address”.

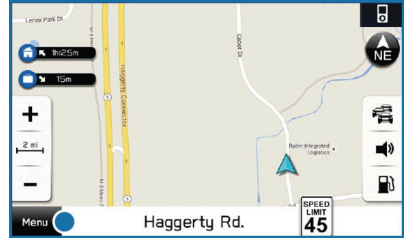

2. The keypad screen displays. As you type the address or name of the destination, suggestions will display. Select the desired destination.



3. The route calculation screen displays three recommended routes at the bottom left of the screen. Select the desired route, then select “GO”. You can also press and hold the route on the map to begin navigation.

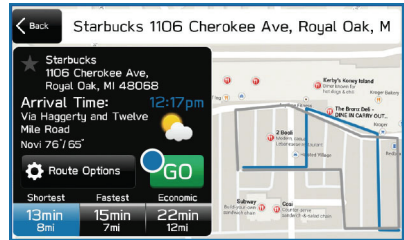

HOW TO APPENDIX

Finding a Destination by POI

To search by Points Of Interest (POI):

1. Push the “Map” button to display the map screen. Then, select “Menu”, followed by “Nearby Places List of POI”.
2. Categories are listed alphabetically. Use the scroll bar on the right, if needed, to display more categories, then make your selection.
3. Select the desired item from the list, then select “GO”.
4. The route calculation screen displays three recommended routes at the bottom left of the screen. Select the desired route, then select “GO”. You can also press and hold the route on the map to begin navigation.

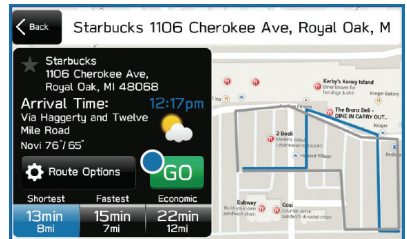
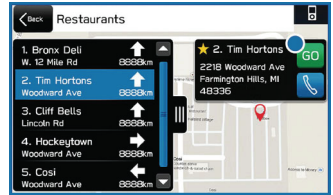
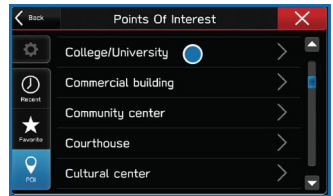

HOW TO APPENDIX

Route Options

You can set the navigation system to avoid various types of routes:

1. Select “Route Options” on the route calculation screen.
2. Select the desired item to avoid.
3. Select the check mark in the upper right corner.

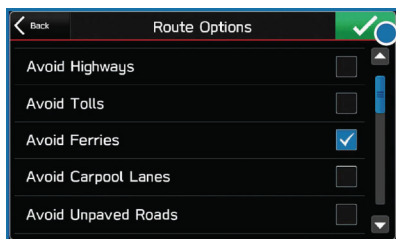

NOTE: The avoidance criteria for the route calculation can also be set from the navigation settings screen.

Shortest/Fastest/Economic

You can set the route preferences to search for the shortest, fastest, or most economic route. To do this:

1. Select “Settings” from the Home screen.
2. Select “Navigation”.
3. Select “Route Settings”.
4. Select the preference you would like to use: Shortest, Fastest, or Most Economic.

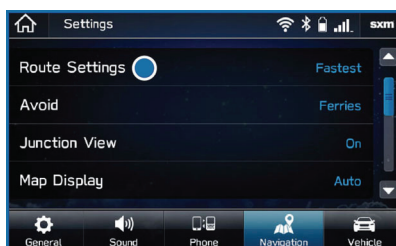

Saving Destination as a Favorite





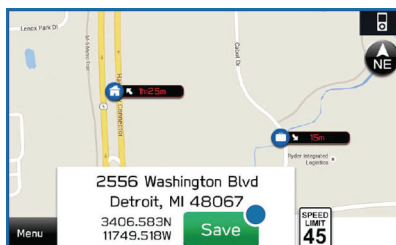











Registered points can be set as a destination. To save a location as a favorite once you have arrived:

1. Select the current street name.
2. Select “Save”.
3. Select to save as Home, Work, or Favorite.



Guidance Screen Icons

The Guidance Screen Icons are the common icons used for the navigation guidance:

| ICON | EXPLANATION | ICON | EXPLANATION |
|---|-------------------------------------|---|---------------------------------------|
|  | Turn left. |  | Stay in the left lane. |
|  | Turn right. |  | Stay in the right lane. |
|  | U-Turn Left. |  | Straight ahead at the intersection. |
|  | U-Turn right. |  | Turn left at the T junction. |
|  | Keep left at the fork in the road. |  | Turn right at the T junction. |
|  | Keep right at the fork in the road. |  | Go left at the roundabout. |
|  | Turn left & sharp curve. |  | You are half way to your destination. |
|  | Turn right & sharp curve. |  | You have arrived at your destination. |

Map Zoom

Once on the map screen, you can zoom in or out by touching the “+” or “-” buttons on the screen. You can also use two fingers on the screen and move them apart to zoom in or together to zoom out.

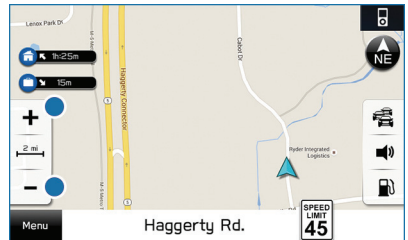

HOW TO APPENDIX

Map View/Perspective

The perspective of the map can be changed between 2D north-up, 2D heading-up, and 3D. To change the view, select the icon at the upper right of the screen. Each time the icon is selected, the view will change as well as the icon to match the map perspective.

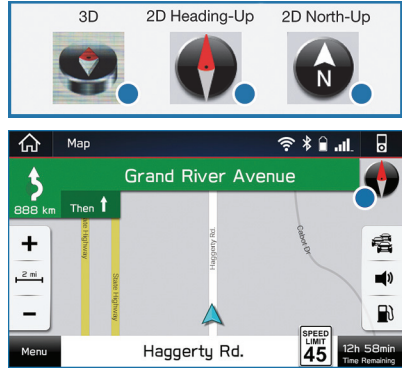

Traffic Information

Road sections affected by traffic conditions are displayed in a different color on the map, and a small icon representing the type of traffic condition is displayed above the road.

A subscription to the SiriusXM[®] Satellite Radio Service is necessary to receive the data service in the vehicle (3 years included).

Nearest Gas Station

To find the nearest gas station, select any point on the map and then select the fuel icon in the lower right corner.

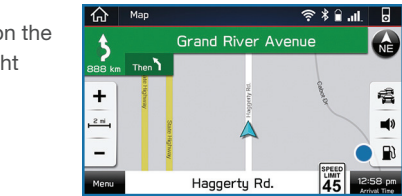

When driving on the highway during route guidance, information on gas stations, restaurants, or rest areas near the next three highway exits will be displayed.



HOW TO APPENDIX

Select the desired item from the list, and then select “GO” to navigate to the closest selected place.

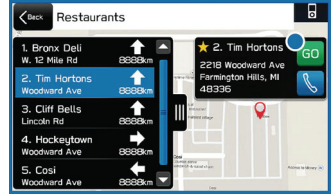

Arrival Time/Distance

Displays the distance to the destination, the estimated travel time to the destination, or the estimated arrival time at the destination. Select the information box in the lower right corner to change between modes.



Canceling Guidance

To cancel guidance, select “Menu” and then select “Cancel”.

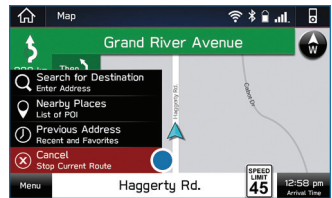

HOW TO APPENDIX

Map Updates

You can update the entire USA map at once via USB by going to:
www.subaru-maps.com

Maps can also be updated over a Wi-Fi network. To update your maps via Wi-Fi, follow this process:

- 1 Connect to a Wi-Fi network. If you need help with this, see page 120.
- 2 On the Home screen, select “Settings” then “Navigation”. Next, select “Map Update” on the navigation setting screen.
- 3 Select “Select Region (Max up to 8)” to select the regions you would like to update.



Scan to learn more about
Map Updates

- 4 Select the regions for which maps are to be updated.

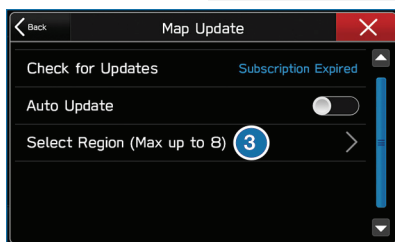

- 5 Select “Back”.



HOW TO APPENDIX

- 6 Select “Check for Updates”.

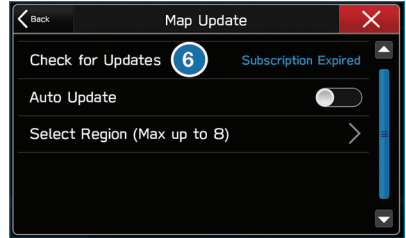

- 7 Check the confirmation message, then select “Yes”.

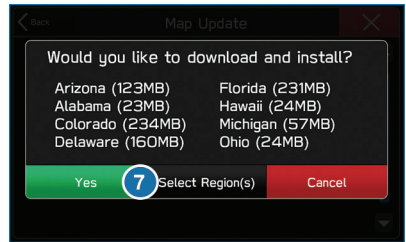

- 8 This screen is displayed simultaneously with the start of the download and installation. Select the “X” in the upper right corner if you need to stop the download and installation.

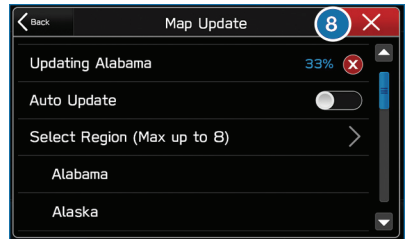

HOW TO APPENDIX

FIRMWARE AND SOFTWARE UPDATES

For 8.0-inch Multimedia Plus and 8.0-inch Multimedia Navigation systems, you can update the system software via a Wi-Fi connection or the aha™ application on your smartphone (depending on your smartphone communication and transfer speed).

To accurately check for updates, make sure the clock is set to “Auto” with a GPS signal available (system with navigation) or a phone paired via Bluetooth® (system without navigation). See page 82 for step by step directions on setting the clock. System functionality will be restricted during installation.

1. Connect to a Wi-Fi network or start the aha application on your smartphone (see page 120).
2. Return to the general settings screen (if needed, press the “Home” button, select “Settings”, and then select “General”).
3. Select “Check for Updates”.
 - If “Automatically Check for Updates” is turned on at the general settings screen, an update check will be performed automatically before proceeding to the next step.
 - If “Automatically Download Updates” is turned on at the general settings screen, the software update will be downloaded automatically before proceeding to “Update Installation”.
4. If the “Software Update Ready to Download” pop-up is displayed, select “Download Now” to begin the download. The download status progress is displayed in the upper right of the screen.
5. Select “Install Now” to start the installation process. The installation process will take several minutes to complete. If you need to stop the installation process, press “Cancel”.
6. When the installation is complete, select “I Agree” on the confirmation message to complete the update process. By selecting “I Agree”, the system will restart automatically.

2.5 L ENGINE 50

A

ACCESSORY CONNECTIONS 27
 ADDING SHORTCUTS 61
 ADVANCED ADAPTIVE CRUISE
 CONTROL 29
 ANDROID AUTO™ 116
 Cables 116
 Compatible Models 118
 Connecting an Android Phone 116
 APPLE CARPLAY® 118
 Cables 118
 Compatible Models 119
 Connecting an iPhone 118
 AUDIO CONTROLS 28
 AUTO START-STOP 38

B

BLIND-SPOT DETECTION (BSD)/ REAR
 CROSS-TRAFFIC ALERT (RCTA) . . . 93
 Blind-Spot Detection (BSD) 93
 Lane Change Assist (LCA) 93
 Rear Cross-Traffic Alert (RCTA) 94
 BLUETOOTH® PAIRING 108
 Pairing an Android Device 108
 Pairing an iOS/Apple Device 112
 BUTTONS 54
 CD Player Functions 55
 Controlling the Volume 55
 Other Functions 55
 Radio Functions 54

C

CARGO COVER 48
 CHILD SAFETY LOCKS 45
 CLIMATE CONTROL 21
 Automatic Climate Control 21
 Dual-Zone Automatic Climate
 Control 23

Heated Seats (if equipped) 25
 Heated Steering Wheel 26
 Rear Heated Seats 26
 Remote Engine Start with Climate
 Control 26
 CLOCK 82
 Automatically 83
 Manually 82
 COMBINATION METER 34
 CREATING A DRIVER PROFILE 62
 Retrieving a Driver Profile 63
 CREATING HOME AND WORK
 PROFILES 74

D

DRIVERFOCUS® COMPONENTS 96
 Camera 96
 Combination Meter Display (CMD) . . . 98
 INFO SWITCH 97
 i/SET Switch 97
 Multi Function Display (MFD) 97
 DRIVERFOCUS® OVERVIEW 96
 DRIVER MONITORING SYSTEM OFF . 100
 DRIVER PROFILE/CONVENIENCE
 SETTINGS 99
 Deleting a Driver 100
 Recognizing a Driver 100
 Registering a Driver 99
 DRIVING THE VEHICLE 36
 Automatic Transmission Shift Mode . 36
 Paddle Shift Control Switches (if
 equipped) 37
 SI-DRIVE 37
 DROWSY/INATTENTIVE WARNINGS . . . 99

E

ELECTRONIC PARKING BRAKE (EPB) . 40
 Auto Vehicle Hold (AVH) 41

INDEX

| | |
|--------------------------------|-----|
| ENGINE OIL | 51 |
| ENGINE OIL CAPACITY | 51 |
| ENROLLMENT | 76 |
| EYESIGHT® DISCLAIMER | 103 |
| EYESIGHT® OVERVIEW | 84 |

F

| | |
|--|-----|
| FIRMWARE AND SOFTWARE | |
| UPDATES | 130 |
| FOLDING THE REAR SEATS | 45 |
| FORESTER | 102 |
| FUEL | 44 |
| FUEL CAPACITY | 44 |
| FUEL FILLER LID | 44 |
| FUNCTIONS | 85 |
| Advanced Adaptive Cruise Control with Lane Centering | 88 |
| Conventional Cruise Control | 89 |
| Lane Departure Prevention | 87 |
| Lane Departure Warning | 86 |
| Lane Sway Warning | 87 |
| Lead Vehicle Start Alert | 90 |
| Pre-Collision Brake Assist | 85 |
| Pre-Collision Braking | 85 |
| Pre-Collision Throttle Management | 86 |

H

| | |
|----------------------------------|-----|
| HIGH BEAM ASSIST (HBA) | 94 |
| HOME SCREEN ICONS | 60 |
| HOOD PROP | 49 |
| HOW TO OVERVIEW | 104 |

I

| | |
|--|----|
| IGNITION SWITCH | 35 |
| IMPORTANT SAFETY INFORMATION | 4 |
| IN CASE OF EMERGENCY | 5 |
| Subaru Roadside Assistance | 5 |
| SUBARU STARLINK® Safety and Security | 5 |

| | |
|--|----|
| INFO SWITCH | 30 |
| INSTRUMENT PANEL SWITCHES (LOWER LEFT) | 28 |
| I/SET SWITCH | 29 |

K

| | |
|--|----|
| KEYLESS ACCESS WITH PUSH BUTTON | |
| START | 9 |
| Locking Using Door Handles | 9 |
| Locking Using the Rear Gate | 10 |
| Unlocking Using Door Handles | 9 |
| Unlocking Using the Rear Gate | 10 |
| KEYLESS ENTRY | 7 |
| Automatic Door Locking/Unlocking | 8 |

L

| | |
|---|----|
| LANE DEPARTURE WARNING AND PRE-COLLISION BRAKING SYSTEM | |
| OFF | 92 |
| Lane Departure Warning OFF Switch | 92 |
| Pre-Collision Braking OFF Switch | 92 |
| LATCH/ANCHOR | 46 |
| LIGHT CONTROLS | 30 |
| Daytime Running Lights | 31 |
| Illumination Brightness | 31 |

M

| | |
|--|-----|
| MAKING A CALL | 66 |
| MAPS | 122 |
| Arrival Time/Distance | 127 |
| Canceling Guidance | 127 |
| Finding a Destination by Address | 122 |
| Finding a Destination by POI | 123 |
| Guidance Screen Icons | 125 |
| Map Updates | 128 |
| Map View/Perspective | 126 |
| Map Zoom | 125 |
| Nearest Gas Station | 126 |
| Route Options | 124 |
| Saving Destination as a Favorite | 124 |

| | |
|---|-----|
| Shortest/Fastest/Economic | 124 |
| Traffic Information | 126 |
| MAPS/NAVIGATION | 80 |
| Checking for Map Updates | 80 |
| Updating Maps Over-the-Air | 80 |
| Updating Maps Using Your PC/MAC | 81 |
| MAPS OVERVIEW | 74 |
| MEDIA | 65 |
| Aux Input | 65 |
| Bluetooth® | 65 |
| CD | 65 |
| USB / iPod | 65 |
| MEMORY DRIVER'S SEAT | 107 |
| MEMORY HEIGHT | 105 |
| MYSUBARU | 73 |
| Service Appointment Scheduler | 73 |
| MYSUBARU INTEGRATION | 77 |

N

| | |
|--------------------------------|----|
| NEW VEHICLE BREAK-IN | 51 |
|--------------------------------|----|

O

| | |
|---|----|
| OPERATION | 84 |
| OVERHEAD CONSOLE | 33 |
| OVERVIEW OF YOUR MULTIMEDIA SYSTEM | 54 |
| Various Systems | 54 |
| OWNER'S RESOURCES | 4 |

P

| | |
|--|----|
| PAIRING A PHONE | 66 |
| PHONE | 79 |
| POWER EXTERIOR MIRRORS | 18 |
| Auto Tilt-down Mirror | 18 |
| POWER MOONROOF | 20 |
| POWER REAR GATE (PRG) | 11 |
| From the Rear of the Vehicle | 12 |
| Power Rear Gate Button | 11 |
| Power Rear Gate Lock | 13 |

| | |
|---------------------------------------|----|
| POWER WINDOWS | 20 |
| PUSH-BUTTON IGNITION SWITCH | 35 |

R

| | |
|--|----|
| RADIO | 64 |
| AM/FM Radio | 64 |
| Presets | 65 |
| Satellite Radio | 64 |
| REARRANGING ICONS | 60 |
| REAR SEAT REMINDER | 47 |
| Passenger Occupant Detection and Seatbelt Reminders | 47 |
| REAR VIEW MIRROR | 19 |
| Auto-dimming Mirror | 19 |
| HomeLink® 5 Accessory Mirror | 19 |
| REAR-VISION CAMERA | 93 |
| Rear-vision Camera Washer | 93 |
| REAR WINDOW WIPER | 32 |
| Rear-vision Camera Washer | 32 |
| RECEIVING A CALL | 67 |
| REVERSE AUTOMATIC BRAKING (RAB) | 95 |
| ROOF RAIL CAPACITY | 52 |

S

| | |
|---|----|
| SAFETY AND SECURITY OVERVIEW | 75 |
| SEATING | 16 |
| Head Restraint Adjustment | 17 |
| Manual Seats | 16 |
| Power Driver's Seat (if equipped) | 16 |
| Seatbelt Adjuster | 17 |
| SETTINGS AND UPDATES OVERVIEW | 78 |
| Connect to Home Wi-Fi | 78 |
| Performing Software Updates | 78 |
| SOUND | 79 |
| SPARE TIRE AND JACK | 48 |
| STARTING THE VEHICLE | 35 |
| Without Push-button Ignition | 35 |
| With Push-button Ignition | 35 |
| STEERING RESPONSIVE HEADLIGHTS (SRH) | 94 |

INDEX

| | |
|--|-----|
| STEERING WHEEL CONTROLS | 57 |
| Advanced Adaptive Cruise Control | 91 |
| Customizing EyeSight® Settings | 92 |
| STEREO CAMERA PRECAUTIONS | 101 |
| SUBARU STARLINK® IN-VEHICLE | |
| APPS | 69 |
| aha™ by HARMAN | 69 |
| Android Auto™ | 70 |
| Apple CarPlay® | 70 |
| Pandora® | 69 |
| SiriusXM® Travel Link | 70 |
| SUBARU STARLINK® MOBILE APP | 71 |
| Chimani | 72 |
| eBird | 72 |
| Quick Reference Guide | 71 |
| Yelp | 71 |
| SUBARU STARLINK® WI-FI HOTSPOT | 77 |

T

| | |
|---|----|
| TEXT MESSAGES | 68 |
| TILT AND TELESCOPIC STEERING | |
| COLUMN | 18 |
| TIRE PRESSURE MONITORING SYSTEM (TPMS) | 53 |
| TOUCHSCREEN | 56 |
| TOWING YOUR ALL-WHEEL DRIVE | |
| SUBARU | 6 |
| TRAILER TOWING CAPACITY | 52 |

| | |
|--|----|
| TURNING OFF THE VEHICLE | 43 |
| Without Push-button Ignition | 43 |
| With Push-button Ignition | 43 |
| TURN SIGNALS | 31 |

V

| | |
|-----------------------------|----|
| VOICE RECOGNITION | 57 |
| Common Commands | 58 |
| Tips | 58 |

W

| | |
|---|-----|
| WARNING AND INDICATOR LIGHTS | 34 |
| WELCOME | 4 |
| WI-FI | 120 |
| Connecting to a Wi-Fi Network | 120 |
| Wi-Fi Hotspot Subscription | 121 |
| WINDSHIELD GLASS AND | |
| DASHBOARD | 101 |
| WINDSHIELD WIPERS | 32 |

X

| | |
|--------------------------------------|----|
| X-MODE® | 41 |
| Hill Descent Control (HDC) | 42 |
| X-MODE® Dual Mode System | 42 |
| X-MODE® Standard System | 42 |

Subaru of America, Inc.
One Subaru Drive
Camden, NJ 08103-9800



MSA5B2102A
Issued November 2020
Printed in USA 11/20

