

Getting Started Guide Impreza 2021



Love. It's what makes Subaru, Subaru.



SUBARU

© 2020 Subaru of America, Inc. Printed in USA. All rights reserved. Contents may not be reproduced in whole or in part without prior written permission of publisher. Specifications in this Guide are based on the latest product information available at the time of publication. Some images shown are for illustration purposes only. Some equipment shown in photography within this Guide is optional at extra cost. Specific options may be available only in combination with other options. Specific combinations of equipment or features may vary from time to time, and by geographic area. Subaru of America, Inc. reserves the right to change or discontinue at any time, without notice: Prices, colors, materials, equipment, accessories, specifications, models and packages, without incurring any obligation to make the same or similar changes on vehicles previously sold. Colors shown may vary due to reproduction and printing processes. Subaru of America, Inc. is not responsible for typographical errors. Aha™ is a trademark of Harman International Industries, Incorporated. Alcantara® is a registered trademark of Alcantara S.p.A., and Alcantara is produced by the Toray Group. App Store® is a registered trademark of Apple, Inc. Apple® is a registered trademark of Apple, Inc. Apple CarPlay® is a registered trademark of Apple, Inc. Android Auto™ is a trademark of Google, LLC. BBS® is a registered trademark of BBS Kraftfahrzeugtechnik, AG. Bluetooth® is a registered trademark of Bluetooth SIG, Inc. Brembo® is a registered trademark of Freni Brembo, S.p.A. GreenEdge® is a registered trademark of Harman International Industries, Incorporated. Glympse® is a registered trademark of Glympse, Inc. Grand Luxe® is a registered trademark of Seiren Co., Ltd. HARMAN® is a registered trademark of HARMAN International Industries, Incorporated. Harman Kardon® is a registered trademark of Harman International Industries, Incorporated. Quantum logic™ is a trademark of Harman International Industries, Incorporated. HD Radio® is a registered trademark of iBiquity Digital Corporation. HomeLink® and the HomeLink® house icon are registered trademarks of Gentex Corporation. iHeartRadio® is a registered trademark of iHeartMedia, Inc. iPod® is a registered trademark of Apple, Inc. iTunes® is a registered trademark of Apple, Inc. Magellan® is a registered trademark of MiTAC International Corporation. Michelin® is a registered trademark of Compagnie Générale des Etablissements Michelin. Metal-Matrix Diaphragm (MMD®) is a registered trademark of Harman International Industries, Incorporated. MirrorLink™ is a trademark of Car Connectivity Consortium, LLC. Pandora® is a registered trademark of Pandora Media, Inc. SACHS® is a registered trademark of ZF Friedrichshafen AG. Siri® is a registered trademark of Apple, Inc. Smart Way® is a registered trademark of the U.S. Environmental Protection Agency. Stitcher™ is a trademark of Stitcher™, Inc. TomTom® is a registered trademark of TomTom International BV. TORSEN LSD® is a registered trademark of JTEKT TORSEN North America, Inc. SiriusXM® All Access Radio is a registered trademark of Sirius XM Radio, Inc. SiriusXM Traffic® is a registered trademark of Sirius XM Radio, Inc. SiriusXM Travel Link® is a registered trademark of SiriusXM Radio, Inc. Ultrasuede® is a registered trademark of Toray Industries, Inc. Yelp® is a registered trademark of Yelp, Inc. Ascent, DriverFocus, and StarDrive, are trademarks of Subaru of America, Inc. Added Security, Crosstrek, Forester, Outback, StarTex and XV Crosstrek are registered trademarks of Subaru of America, Inc. BRZ, Confidence in Motion, EyeSight, Impreza, Lineartronic, Legacy, S209, Subaru, SUBARU STARLINK®, SUBARU BOXER, tS (Design), WRX, STI and X-MODE are registered trademarks of Subaru Corporation.

TABLE OF CONTENTS



PURPOSE OF THIS GUIDE

WELCOME	4
IMPORTANT SAFETY INFORMATION	4
OWNER'S RESOURCES	4
IN CASE OF EMERGENCY	5
TOWING YOUR ALL-WHEEL DRIVE SUBARU	6

ENTRY AND EXIT

KEYLESS ENTRY	7
KEYLESS ACCESS WITH PUSH BUTTON START	9

INSTRUMENT PANEL

GETTING COMFORTABLE

SEATING	14
TILT AND TELESCOPIC STEERING COLUMN	16
POWER EXTERIOR MIRRORS ..	16
REAR VIEW MIRROR	17
POWER WINDOWS	18
POWER MOONROOF	19
CLIMATE CONTROL	20
ACCESSORY CONNECTIONS ..	24

CONTROLS

INSTRUMENT PANEL SWITCHES (LOWER LEFT)	25
AUDIO CONTROLS	25
CRUISE CONTROL	26

ADAPTIVE CRUISE CONTROL I/SET SWITCH	27
INFO SWITCH	27
LIGHT CONTROLS	28
TURN SIGNALS	29
WINDSHIELD WIPERS	29
REAR WINDOW WIPER (5-door Models)	29
OVERHEAD CONSOLE	30

GAUGES AND WARNING LIGHTS

GAUGES	31
WARNING AND INDICATOR LIGHTS	32

OPERATING THE VEHICLE

IGNITION SWITCH	33
PUSH-BUTTON IGNITION SWITCH	33
STARTING THE VEHICLE	33
DRIVING THE VEHICLE	34
TURNING OFF THE VEHICLE ..	36

REFUELING

FUEL FILLER LID	37
FUEL	37
FUEL CAPACITY	37

PASSENGER/CARGO AREAS

FOLDING THE REAR SEATS ...	38
CHILD SAFETY LOCKS	38

TABLE OF CONTENTS

LATCH/ANCHOR	39	APPS	
REAR SEAT REMINDER	40	SUBARU STARLINK® IN-VEHICLE	
INTERNAL SAFETY TRUNK		APPS	64
RELEASE WITH SELF-		SUBARU STARLINK® MOBILE	
ILLUMINATING HANDLE (Sedan		APP	66
Models)	40	MYSUBARU	68
TRUNK LID OPENER (Sedan			
Models)	41	MAPS (if equipped)	
CARGO COVER (5-door		CREATING HOME AND WORK	
Models)	41	PROFILES	69
SPARE TIRE AND JACK	42	FINDING A DESTINATION	69
ENGINE COMPARTMENT		STARLINK SAFETY AND	
HOOD PROP	43	SECURITY	
2.0L ENGINE	44	SAFETY AND SECURITY	
ADDITIONAL SPECIFICATIONS		OVERVIEW	75
NEW VEHICLE BREAK-IN	45	ENROLLMENT	76
ENGINE OIL	45	MYSUBARU INTEGRATION	76
ENGINE OIL CAPACITY	45	SUBARU STARLINK® WI-FI	
ROOF RAIL CAPACITY	46	HOTSPOT	77
TRAILER TOWING CAPACITY	46		
TIRE PRESSURE MONITORING		SETTINGS AND UPDATES	
SYSTEM (TPMS)	47	GENERAL	78
STARLINK OVERVIEW		SOUND	79
OVERVIEW OF YOUR MULTIMEDIA		PHONE	80
SYSTEM	48	MAPS/NAVIGATION	80
BUTTONS	48	CLOCK	81
TOUCHSCREEN	50	EYESIGHT	
STEERING WHEEL CONTROLS	51	EYESIGHT® OVERVIEW	84
VOICE RECOGNITION	52	OPERATION	84
STARLINK HOME		FUNCTIONS	85
HOME SCREEN ICONS	54	STEERING WHEEL CONTROLS	90
REARRANGING ICONS	54	LANE DEPARTURE WARNING AND	
ADDING SHORTCUTS	55	PRE-COLLISION BRAKING	
DRIVER PROFILE		SYSTEM OFF SWITCHES	91
CREATING A DRIVER PROFILE	56	DRIVER ASSIST	
MULTIMEDIA		TECHNOLOGIES	
RADIO	58	REAR-VISION CAMERA	92
MEDIA	60	BLIND-SPOT DETECTION (BSD)/	
PHONE		REAR CROSS-TRAFFIC ALERT	
PAIRING A PHONE	61	(RCTA)	92
MAKING A CALL	61	HIGH BEAM ASSIST (HBA)	93
RECEIVING A CALL	62	STEERING RESPONSIVE	
TEXT MESSAGES	63	HEADLIGHTS (SRH)	93
		REVERSE AUTOMATIC BRAKING	
		(RAB)	94

TABLE OF CONTENTS

CARE AND LIMITATIONS

STEREO CAMERA PRECAUTIONS	95
WINDSHIELD GLASS AND DASHBOARD	95

FRONT VIEW

Impreza (Front View)	96
--------------------------------	----

EYESIGHT DISCLAIMER. 97

HOW TO APPENDIX

HOW TO OVERVIEW	98
BLUETOOTH® PAIRING	98
ANDROID AUTO™	106
APPLE CARPLAY®	108
WI-FI	110
FIRMWARE SOFTWARE UPDATES	111
MAP UPDATES	112

INDEX 114

PURPOSE OF THIS GUIDE

WELCOME

Congratulations on choosing a Subaru Impreza and welcome to the Subaru family!

Subaru is more than a car company™. We are committed to making the world a better place, and the Subaru Love Promise is our vision to show love and respect to all people at every interaction with Subaru. We believe in building lifelong relationships with our customers, earning your trust and exceeding your expectations by providing customer service with integrity and compassion.

This Getting Started Guide will introduce you to your new Subaru Impreza by providing information on the basic operation and key features of your Subaru as well as the STARLINK® and EyeSight® systems in your vehicle.

IMPORTANT SAFETY INFORMATION

The Getting Started Guide is not intended as a substitute for the Owner's Manuals. We strongly encourage you to review the vehicle, STARLINK®, and EyeSight® Owner's Manuals to ensure complete understanding.

OWNER'S RESOURCES

If you're having difficulty using any of the functions outlined in this guide, or to learn more, you can get more information from the following sources:

Your Subaru Owner's Manuals:

Located in the glovebox

Online Subaru Owner's Resources:

www.subaru.com/owners

Subaru Customer Support:

www.subaru.com/customer-support

1-800-782-2783 (1-800-SUBARU3)



Scan to learn more about Owner's Resources.



Scan to learn more about Customer Support.



Scan to get the **MySubaru** App.



Scan to get the **SUBARU STARLINK®** App.

PURPOSE OF THIS GUIDE

IN CASE OF EMERGENCY

SUBARU STARLINK® Safety and Security (subscription required)

SOS Emergency: Press the red “SOS” button on the overhead panel in the event of an emergency to speak with a SUBARU STARLINK® Customer Care Advisor.

Enhanced Roadside Assistance: Press the blue “i” button on the overhead panel or select the “Roadside Assistance” option in the “MySubaru” menu on the multimedia system.



SOS and Roadside Assistance Buttons

For more information, please refer to “Safety and Security Overview” on page 75 or the SUBARU STARLINK® Safety and Security Owner’s Manual.

Subaru Roadside Assistance

Subaru Roadside Assistance:
1-800-261-2155

Subaru Roadside Assistance is free and standard on your Subaru; there are no forms to complete. This service is available anytime during the 3-year/36,000-mile Subaru Limited Warranty, whichever comes first. See your retailer for details and refer to the Roadside Assistance guide in the owner’s information kit for the details on this coverage. A Subaru Roadside Assistance decal has been affixed to the driver’s door window.

Roadside assistance helps with:

- Towing to the nearest authorized Subaru retailer if you cannot safely drive your Subaru
- Jump-start if your battery is dead
- Gasoline delivery if you run out of gas
- Flat tire change to install your spare
- Emergency lockout service
- National Subaru retailer locator service, with phone numbers and location of the nearest retailer anywhere in the U.S. or Canada

NOTE: Specifically excluded from Subaru Roadside Assistance coverage are service requests or claims resulting from: accidents, vandalism, acts of God, violation of any laws, or vehicle modifications not recommended by the manufacturer.

PURPOSE OF THIS GUIDE

TOWING YOUR ALL-WHEEL DRIVE SUBARU

Since Subaru Symmetrical All-Wheel Drive distributes power to all four wheels, improper towing may damage your AWD system. The best way to tow your Impreza is with a flatbed truck by your Subaru retailer or a commercial towing service.

KEYLESS ENTRY

1 Lock/Arm

- Press the lock/arm button to lock the doors and trunk/rear gate and to activate the security alarm. A chirp sounds and the hazard warning lights flash once.
- If any of the doors or the trunk/rear gate are not fully closed, five rapid chirps sound and the hazard warning lights will flash to alert you.
- Press the lock/arm button three times to activate the vehicle finder function. If you are within 30 feet of your Subaru, the horn sounds once, and the hazard warning lights flash three times.

2 Unlock/Disarm

- Press the unlock/disarm button once to unlock the driver's door. To unlock all the doors and the trunk/rear gate, briefly press the button twice. Two chirps sound and the hazard warning lights flash once.
- The interior lights will illuminate when you press the unlock/disarm button if they are set to the "DOOR" position on the overhead console.

3 Trunk/Rear Gate

- For sedan models, press and hold this button to open the trunk.
- For 5-door models, press this button to unlock the rear gate.

4 Panic Alarm

- Press the panic alarm button to sound the horn and flash the hazard warning lights.
- Press any button on the access key fob or transmitter to deactivate the panic alarm.



Access Key Fob



Transmitter

ENTRY AND EXIT

Automatic Door Locking/Unlocking

This feature allows you to set when your Subaru automatically locks or unlocks the doors through the Combination Meter Display (use the i/Set Switch to navigate to “Vehicle Settings” then “Auto Door Lock or Unlock”) or the STARLINK® Touchscreen (select “Settings” then “Vehicle”). The available settings are listed in the table below.

	AVAILABLE SETTINGS			
AUTO DOOR LOCK	Vehicle Speed (12 mph)	Shift into or out of PARK	OFF	
AUTO DOOR UNLOCK	Driver’s Door Open	Ignition OFF	Shift into or out of PARK	OFF

KEYLESS ACCESS WITH PUSH BUTTON START (if equipped)

The Keyless Access with Push-Button Start system features touch-activated door locking or unlocking and push-button start functions without the key ever leaving your pocket or purse. You can customize the touch-activated door locking or unlocking settings using the i/Set switch to navigate to “Vehicle Settings” then “Keyless Entry System” in the Combination Meter Display or through the STARLINK® Touchscreen by selecting “Settings” then “Vehicle”.

Unlocking Using Door Handles

Grip the driver’s door handle to unlock the driver’s door (or all doors depending on the setting). Grip the front passenger’s door handle to unlock all doors and the trunk/rear gate. Two chirps sound and the hazard warning lights flash twice.



Door Unlock Sensor

Locking Using Door Handles

Close all doors and the trunk/rear gate and touch the door lock sensor (two lines) on either front door handle. All doors and the trunk/rear gate will lock. One chirp sounds and the hazard warning lights flash once.



Door Lock Sensor

ENTRY AND EXIT

Unlocking the Trunk (Sedan Models)

Press the trunk opener button to unlock and open the trunk. Two chirps sound and the hazard warning lights flash twice.



Trunk Opener Button

Unlocking Using the Rear Gate (5-door Models)

Press the rear gate opener button to unlock and open the rear gate (or also unlock all doors depending on the setting). Two chirps sound and the hazard warning lights flash twice.



Rear Gate Opener Button

Locking Using the Rear Gate (5-door models)

Close all the doors and the rear gate and press the rear lock button. All doors and the rear gate lock. One chirp sounds and the hazard warning lights flash once.



Rear Lock Button

INSTRUMENT PANEL

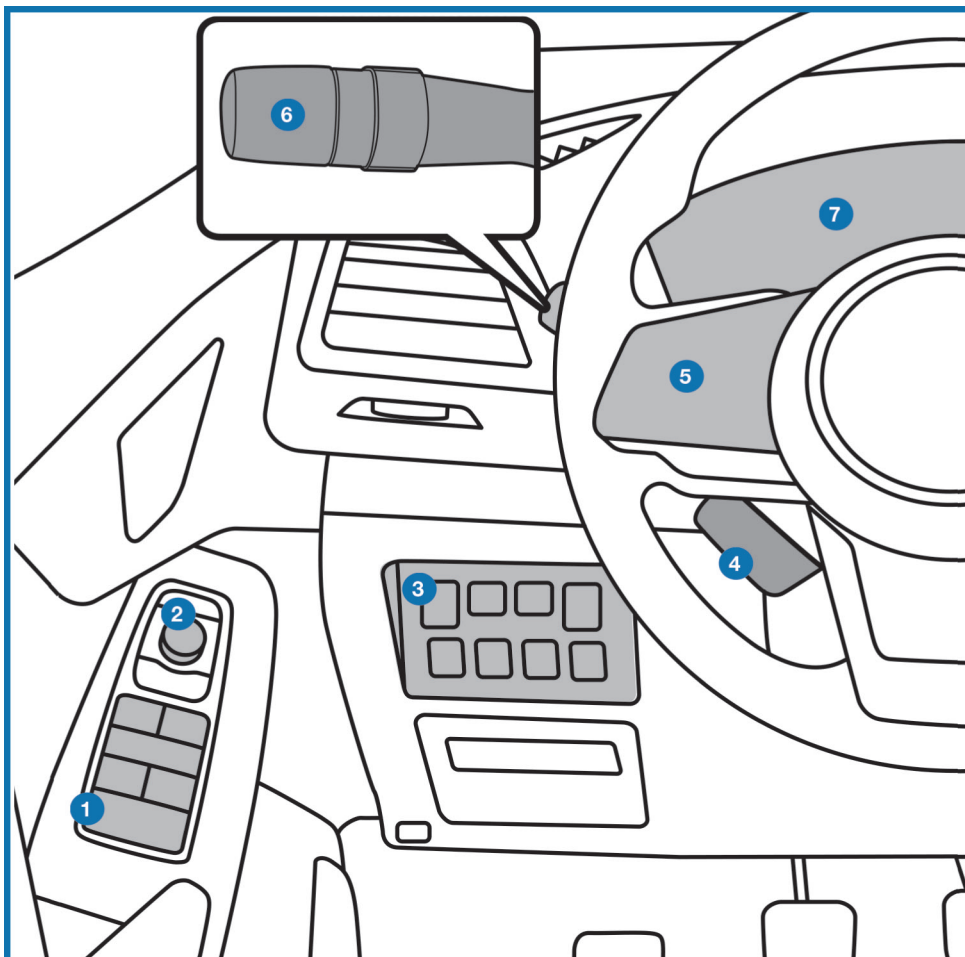

- ① Power Window Switches (p. 18)
- ② Power Exterior Mirror Switch (p. 16)
- ③ Instrument Panel Switches (p. 25)
- ④ I/Set Switch (p. 27)
- ⑤ Audio Controls (p. 25)
- ⑥ Light Controls (p. 28)
- ⑦ Combination Meter (p. 31)

INSTRUMENT PANEL

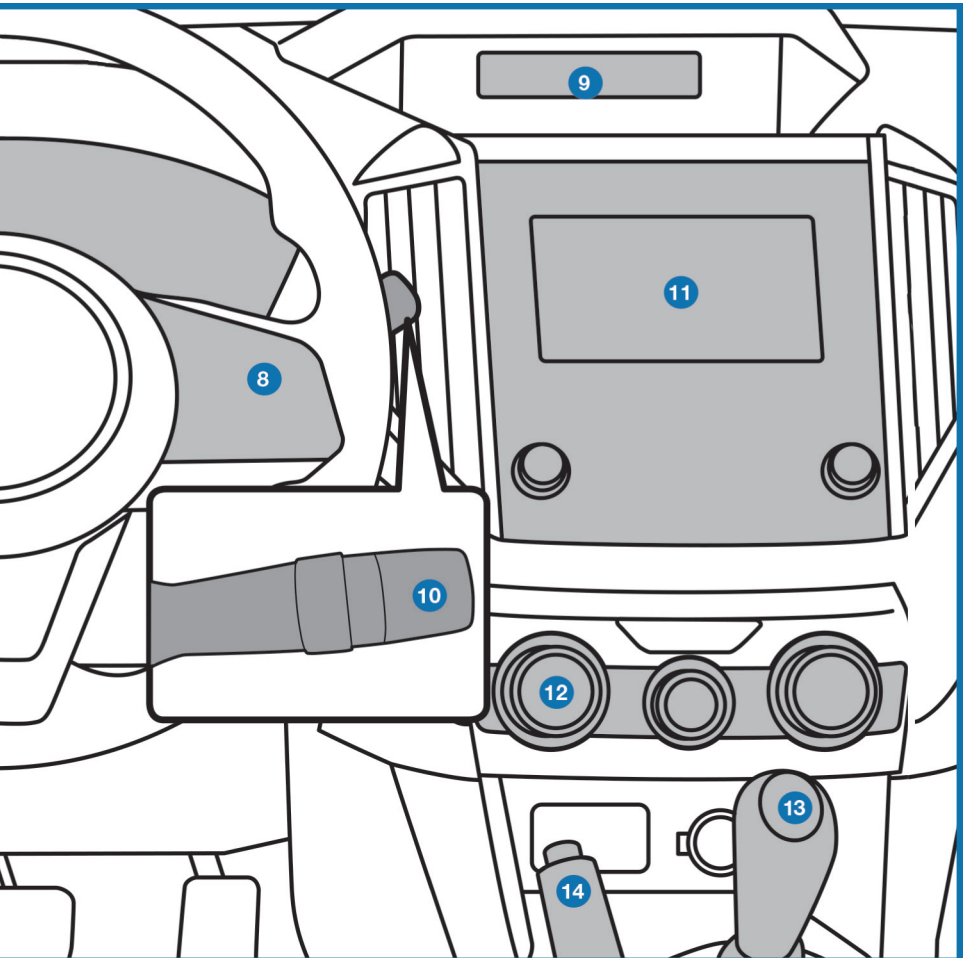

- ⑧ Cruise Control or Adaptive Cruise Control (p. 26)
- ⑨ Multi-Function Display (MFD) (p. 27)
- ⑩ Windshield Wipers (p. 29)
- ⑪ SUBARU STARLINK® Multimedia Touchscreen (p. 48)
- ⑫ Climate Control System (p. 20)
- ⑬ Shifter (MT) or CVT Select Lever (p. 34)
- ⑭ Parking Brake

GETTING COMFORTABLE

SEATING

Manual Seats

- 1 Forward/Backward:** Pull the lever below the seat up and slide the seat forward or backward. Release the lever and make sure the seat is locked into place.
- 2 Seat Height (Driver's Seat):** Pulling up or pushing down on the lever will raise or lower the seat cushion.
- 3 Recline Seatback:** Pull the lever up to adjust the seatback. Release the lever and make sure the seatback is locked into place.



Manual Seat Levers

Power Driver's Seat (if equipped)

- 1 Seat Position:** Moving the switch forward or backward will adjust the seat in that direction. Pulling up or pushing down on the back of the switch will adjust the seat height up or down.
- 2 Recline Seatback:** Moving the top of the switch forward or backward will adjust the angle of the seatback.



Power Seat Controls

GETTING COMFORTABLE

Head Restraint Adjustment

Pull the head restraint up to raise it. To lower the head restraint, push it down while pressing the release button on the top of the seatback. Each head restraint should be adjusted so that the center of the head restraint is closest to the top of the occupant's ears.

The angle of the front head restraints can be adjusted by tilting them forward. You will hear a click when the restraint locks in place. Pulling the head restraint as far forward as it will go allows it to return to the fully upright position.

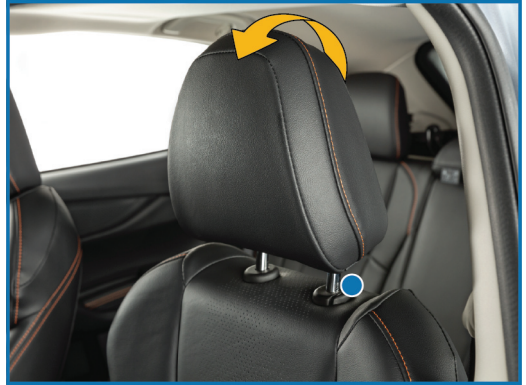

Release Button and Head Restraint Adjustment

Seatbelt Adjuster

To keep yourself comfortable and safe, always position the seatbelt adjuster so the shoulder belt passes over the middle of your shoulder without touching your neck. Pull the tab out and slide the adjuster up or down to set the position. Release the tab and make sure the adjuster is locked in place.



Seatbelt Adjustment Tab

GETTING COMFORTABLE

TILT AND TELESCOPIC STEERING COLUMN

You can adjust both the height and lengthwise position of the steering wheel. Pull the lever on the side of the steering column down firmly to unlock, then adjust the position of the steering wheel. Push the lever firmly back up to lock the column in place.



Steering Column Unlock

POWER EXTERIOR MIRRORS

Turn the knob to “L” (left side) or “R” (right side) to select a mirror. Push the knob in the direction you want to move the mirror. Turn the knob back to the center position when finished.



Power Mirror Knob

GETTING COMFORTABLE

REAR VIEW MIRROR

Auto-dimming Mirror (if equipped)

The auto-dimming function senses distracting glare during nighttime driving and automatically dims to eliminate the glare and preserve your vision. Press the switch to turn auto-dimming on or off. A green LED indicator on the switch illuminates when the function is on.



HomeLink® 5 Accessory Mirror (if equipped)

The HomeLink® 5 accessory mirror provides three buttons to replace devices such as garage door openers, gate openers, entry door locks, security systems, and home lighting. The Owner's Manual provides programming instructions, and www.subaru.com/homelink has a helpful "how to" video.



NOTE: HomeLink® 5 may not be compatible with some older door openers or additional equipment may be required.



Scan to learn more about HomeLink®.

GETTING COMFORTABLE

POWER WINDOWS

To open or close a window, partially press down or pull up and hold the corresponding switch. The front windows have a one-touch auto up/down function. Fully press down or pull up and release to automatically open or close a one-touch window.



Power Window Switches

POWER MOONROOF (if equipped)

With the ignition in the “ON” position, you can tilt and slide the moonroof.

Tilting the Moonroof

- 1 Opening:** Press, briefly hold, and release to automatically tilt the moonroof.
- 2 Closing:** Press and hold the switch to lower the moonroof.

Sliding the Moonroof

- 3 Opening:** Press, briefly hold, and release the switch to open the moonroof. To pause the moonroof halfway, press either side of the switch.
- 4 Closing:** Press, briefly hold, and release the switch to close the moonroof. To pause the moonroof halfway, press either side of the switch.



Power Moonroof Switches

GETTING COMFORTABLE

CLIMATE CONTROL

Manual Climate Control



1 Air Flow Control Dial

The air flow control dial allows you to choose the direction of air flow. Rotate the dial for the desired air flow position.

Defrost/Defog

To clear the windshield and front door windows of fog or frost, rotate the air flow control dial to the defrost position, set the temperature control to the red position, and set the fan speed control to the fastest speed.

2 Rear Window Defogger Button

Press the rear window defogger button to turn on the defogger. The defogger will automatically shut off after about 15 minutes. If the window clears before that time, you can press the button again to turn it off. This button also turns the heated mirrors on and off, if equipped.

3 Fan Speed Control Dial

Rotate the fan speed control dial to select the desired fan speed.

4 Recirculated/Outside Air Button: Press this button to prevent outside air from entering your Subaru. Press the button again to allow outside air into your Subaru.
NOTE: To prevent windshield fogging, do not remain in the recirculated mode for an extended period of time.

5 Temperature Control Dial

Rotate the temperature control dial clockwise to increase the temperature and counterclockwise to decrease the temperature.

6 Air Conditioning Button

Press the "A/C" button to activate the air conditioning. Press it again to turn off the air conditioning.

GETTING COMFORTABLE

Automatic Climate Control



Set your desired temperature and let the system automatically make the adjustments for you. At any time, you can manually take control of the climate settings.

Operation in Automatic Mode

- 1 Automatic Control Button:** This system automatically controls all of the climate system except defogging. Press “AUTO” to activate. Press “OFF” to turn off the system.
- 2 Temperature Control Dial:** Turn the dial clockwise to increase the temperature or counterclockwise to decrease the temperature. The temperature will appear on the Multi-Function Display (MFD).

When using automatic mode, the fan speed, airflow distribution, air-inlet control and air conditioning compressor are controlled automatically. To activate:

1. Press the “AUTO” button. The “FULL AUTO” indicator light illuminates on the Multi-Function Display (MDF).
2. Set the preferred temperature using the temperature control dial.







If you operate any of the buttons other than “ON/OFF”, rear window defogger, or the temperature control dial, the “FULL” indicator light will turn off. The “AUTO” light will remain illuminated. You can then manually control the system as desired. Press the “AUTO” button to change back to “FULL AUTO” mode.

Operation in Manual Mode

- 3 Air Conditioner Button:** Press this button to activate or deactivate the air conditioning.
- 4 MAX A/C Button:** Press this button for quickest cooling.

GETTING COMFORTABLE

- 5 Airflow Mode Selection Dial:** Turn the dial to select the desired airflow mode. The selected mode – ventilation, bi-level, ventilation 2, feet, or feet-defrost – is shown on the display.

ICON	MODE	FUNCTION
	Ventilation	Instrument panel outlets
	Bi-Level	Instrument panel outlets and foot outlets
	Ventilation 2	Instrument panel outlets and less foot outlets than bi-level
	Feet	Foot outlets, both side outlets of the instrument panel and some through windshield defroster outlets
	Feet-Defrost	Windshield defroster outlets, foot outlets and both side outlets of the instrument panel
	Defrost	Windshield defroster outlets and both side outlets of the instrument panel

NOTE: The defroster button is used to activate the defrost airflow mode.

- 6 Fan Speed Control Dial:** Turn the fan speed control dial to increase or decrease fan speed.
- 7 Recirculated/Outside Air Button:** Press this button to prevent outside air from entering your Subaru. Press the button again to allow outside air into your Subaru.
NOTE: To prevent windshield fogging, do not remain in the recirculated mode for an extended period of time.
- 8 Defroster Button:** Press this button to defrost or dehumidify the windshield and front door windows.
NOTE: The air conditioning may turn on to defrost the windshield more quickly. However, the indicator on the air conditioner button will not illuminate.

GETTING COMFORTABLE

- 9 Rear Window Defogger Button:** Press this button to turn on the defogger. It will automatically turn off after about 15 minutes. If the window clears before then, press the button again to turn it off. If equipped, the outside mirror defogger and windshield wiper deicer will also activate. You can customize this function for continuous operation through the Combination Meter Display (CMD) or the STARLINK® Touchscreen by selecting “Settings” then “Vehicle”.

Heated Seats (if equipped)

The heated seat switches are located between the driver and passenger seats. There is a separate switch for the driver and passenger. Press the “HI” button for the high temperature setting or press the “LO” button for the low temperature setting. Return the switch to the center position to turn off the heated seat.



Heated Seat Switches

Remote Engine Start with Climate Control



This feature can also be set through **MySubaru.com** or the **MySubaru App**



MySubaru App



MySubaru.com

You can remotely start your Subaru and adjust the temperature using the STARLINK® Safety and Security features through the **MySubaru App** (subscription required). Please refer to your SUBARU STARLINK® Owner's Manual for a list of required vehicle conditions for this feature.

GETTING COMFORTABLE

ACCESSORY CONNECTIONS

1 Auxiliary Input Jack:

The 3.5mm auxiliary input jack is located below the climate control dials. You can connect a portable music player to the auxiliary jack and hear the music stored on it through your Subaru's speakers. Press the "Source" button located on the steering wheel or the "Media" button on the STARLINK® Touchscreen to select the auxiliary mode.

For more information, please refer to page 60 or your SUBARU STARLINK® Owner's Manual.

2 Dual USB Ports:

The USB ports are located below the climate control dials and, if equipped, in the center console. You can connect a variety of USB-equipped devices to the front ports, such as portable music players or smartphones, to enjoy your favorite music through your Subaru's speakers. These ports also provide charging (5V, 2.1A) to devices. The ports inside the center console are for charging only.

For more information, please refer to page 60 or your SUBARU STARLINK® Owner's Manual.

3 Power Outlets:

Power outlets (12V) are located below the climate control dials and in the center console. Electrical power is available for use with in-vehicle electrical appliances with a maximum power rating of 120W. These outlets cannot be used to connect to the SUBARU STARLINK® Multimedia System.

For more information, please refer to your Owner's Manual.

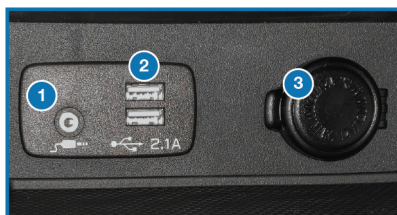

Connection Ports

INSTRUMENT PANEL SWITCHES (LOWER LEFT)

The switches in the lower left of the instrument panel allow you to control several convenient and important features. Knowing their location and function will improve your driving experience.

- 1 Steering Responsive Headlights OFF (if equipped) (see p. 93)
- 2 Illumination Brightness (see p. 28)
- 3 Vehicle Dynamics Control OFF
- 4 Blind Spot Detection/Rear Cross Traffic Alert OFF (if equipped) (see p. 92)



For more information, please refer to your EyeSight® and vehicle Owner's Manuals.

AUDIO CONTROLS

- 1 Presets/Skip
- 2 Volume
- 3 Source
- 4 INFO
- 5 Call/Voice Recognition

For more information about your audio system and controls, please refer to page 51 or the SUBARU STARLINK® Owner's Manual.



CONTROLS

CRUISE CONTROL

- 1 Cruise Control On/Off
 - 2 Resume (RES)/Increase Speed and Set (SET)/Decrease Speed
 - 3 CANCEL Button
- For more information, please refer to your Owner's Manual.



ADAPTIVE CRUISE CONTROL (if equipped)

- 1 Adaptive Cruise Control On/Off
 - 2 Lane Keep Assist
 - 3 Increase Distance
 - 4 Decrease Distance
 - 5 Resume (RES)/Increase Speed and Set (SET)/Decrease Speed
 - 6 SI-Drive (if equipped)
- For more information on SI-Drive, please refer to page 35 or your Owner's Manual.
- For more information on Adaptive Cruise Control, please refer to page 90 or the EyeSight® Owner's Manual.



I/SET SWITCH

The “i/Set” switch allows you to cycle through useful driving information in the Combination Meter Display such as fuel consumption, driving time, speed, and tire pressure. You can change the information displayed using the up and down arrows.



When the Menu Entering Screen is displayed, pull and hold the “i/Set” switch to enter the Menu Screen for the ability to modify a number of vehicle settings.

 For more information, please refer to “Combination Meter Display” in your Subaru Owner’s Manual.

INFO SWITCH

Press the INFO switch to cycle through useful information in the Multi-Function Display (MFD). Navigate to the guidance screen and hold the INFO switch to access the settings menu and adjust a number of MFD settings.

 For more information, please refer to “Multi-Function Display” in your Subaru Owner’s Manual.



CONTROLS

LIGHT CONTROLS

- 1 AUTO:** If equipped, rotate the end of the lever to set your headlights to automatically turn on or off, depending on the level of light outside.
NOTE: The sensitivity of the automatic headlights can be adjusted through the STARLINK® multimedia display.
- 2 Parking Lights:** Rotate the end of the lever to turn on the instrument panel lights, parking lights, side marker lights, tail lights, and license plate lights.
- 3 Headlights:** Rotate the end of the lever to turn on the headlights, instrument panel lights, parking lights, side marker lights, tail lights, and license plate lights.
- 4 High Beams:** Push the lever forward to change from low beam to high beam. When set to the “AUTO” position, pushing the lever forward also activates the High Beam Assist (HBA) system, if equipped. Pull the lever back to center to return to low beam.
- 5 Fog Lights:** If equipped, rotate the dial to turn on the fog lights.



Illumination Brightness



While the light controls are on, rotating the illumination brightness dial on the instrument panel upward will make the instrument panel illumination brighter. When the dial is fully rotated upward (dots aligned), the instrument panel illumination stays at full brightness. Rotating the dial downward dims the instrument panel illumination.

For map equipped vehicles, this setting also adjusts the day/night view and illumination level.



Illumination Brightness Dial

Daytime Running Lights

The daytime running lights automatically turn on when the engine is running, the parking brake released, the select lever is out of the “P” position, and the light switch is set to Off, “AUTO” (if equipped), or “”. Always turn on the headlights when it’s dark outside by rotating the dial to the “” or “AUTO” position.

TURN SIGNALS

Push fully up for the right turn signal and fully down for left turn signal. Your Subaru also has a one-touch lane changer feature: push slightly up and release to signal a right lane change or push slightly down and release to signal a left lane change.



WINDSHIELD WIPERS

To turn on the wipers, press the wiper control lever down one position for intermittent, two positions for low speed, or three positions for high speed. When the lever is in the intermittent position, rotate the dial to adjust the operating interval of the wipers. To turn the wipers off, return the lever to the “OFF” position. For a single wipe, move the lever up from the off position.



Pull the lever toward you to wash the windshield. The washer will spray and the wipers will operate while you pull the lever.

REAR WINDOW WIPER (5-door Models)

Rotate the end of the lever up one position for intermittent, or two positions for continuous operation.

When the lever is in the intermittent position, the wiper operates at intervals corresponding with vehicle speed. When you move the select lever to the “R” position, the wiper will switch to continuous operation. It will return to intermittent when you move the select lever out of “R”.



Rotate the dial up from the continuous operation position or down from the “OFF” position to spray washer fluid. The washer will spray until you release the dial, then return to the previous position and resume operation.

CONTROLS

OVERHEAD CONSOLE

1 SOS Emergency

Assistance: Press the red “SOS” button to connect with a SUBARU STARLINK® Customer Care Advisor (subscription required). Press and hold the button for about two seconds to cancel the call.

📌 For more information, please refer to page 75 or the SUBARU STARLINK® Safety and Security Owner’s Manual.

2 **Enhanced Roadside Assistance:** Press the blue “i” button to connect with a SUBARU STARLINK® Roadside Assistance Provider (subscription required). Press and hold the button for about two seconds to cancel the call.

📌 For more information, please refer to page 75 or the SUBARU STARLINK® Safety and Security Owner’s Manual.

3 **Automatic Illumination:** When the switch is in the “DOOR” position, the map lights illuminate when any door is opened, the doors are unlocked using the remote keyless entry system or keyless access function, or the ignition is turned from “ON” or “ACC” to “LOCK”/“OFF”.

4 **Lane Departure Warning OFF Switch:** Press and hold this switch for two seconds to turn off Lane Departure Warning and Lane Sway Warning. Press and hold the switch again for two seconds to turn the systems back on.

📌 For more information, please refer to page 91 or the EyeSight® Owner’s Manual.

5 **Pre-Collision Braking System OFF Switch:** Press and hold this switch for two seconds to turn off the Pre-Collision Braking System and Pre-Collision Throttle Management. Press and hold the switch again for two seconds to turn the systems back on.

📌 For more information, please refer to page 91 or the EyeSight® Owner’s Manual.

6 **Map Lights:** Press a map light to turn it on or off.

7 **Power Moonroof Switch:** Operate these switches to tilt and slide the moonroof.



GAUGES AND WARNING LIGHTS

GAUGES

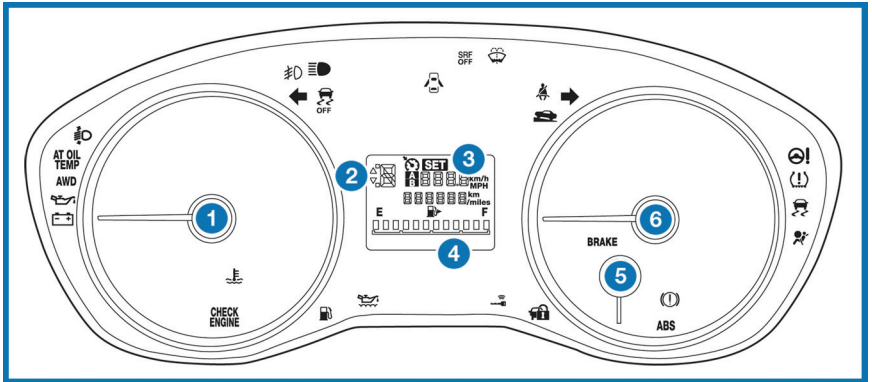

Impreza, Impreza Premium

- | | |
|------------------------------|---------------|
| 1 Tachometer | 4 Fuel Gauge |
| 2 Select Lever/Gear Position | 5 ECO Gauge |
| 3 Trip Meter and Odometer | 6 Speedometer |

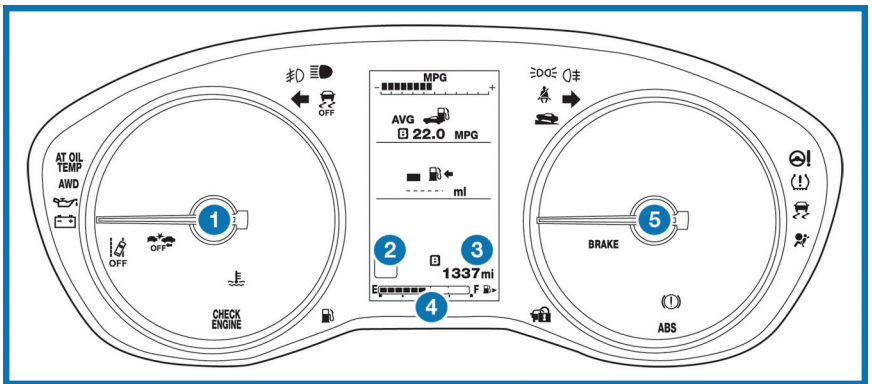



Impreza Premium with Driver Assist Technology, Impreza Sport, Impreza Limited

- | | |
|----------------------------------------|---------------|
| 1 Tachometer | 4 Fuel Gauge |
| 2 Select Lever/Gear Position Indicator | 5 Speedometer |
| 3 Trip Meter and Odometer | |



GAUGES AND WARNING LIGHTS

WARNING AND INDICATOR LIGHTS



Red lights indicate immediate attention is required. Some examples are:

	Seatbelt warning		Door open	BRAKE / 	Brake system
-----------------------------------------------------------------------------------	------------------	-----------------------------------------------------------------------------------	-----------	--------------------------------------------------------------------------------------------------	--------------

Yellow lights indicate caution. Some examples are:

	Low fuel		Engine oil level warning light		Tire pressure warning light
-----------------------------------------------------------------------------------	----------	-----------------------------------------------------------------------------------	--------------------------------	-----------------------------------------------------------------------------------	-----------------------------

Green and blue lights are for information. Some examples are:

	Headlight indicator light		Cold coolant temperature		High beam indicator light
----------------------------------------------------------------------------------	---------------------------	-----------------------------------------------------------------------------------	--------------------------	-----------------------------------------------------------------------------------	---------------------------

OPERATING THE VEHICLE

IGNITION SWITCH

The ignition switch has four positions:

LOCK: You can only insert or remove the key in this position.

ACC (Accessory): Provides power to the radio and accessory power outlets.

ON: All electrical systems are available. The key returns to this position after starting the engine.

START: Turn the key to this position to start the engine.

PUSH-BUTTON IGNITION SWITCH (if equipped)

Each time you press the ignition switch without depressing the brake pedal, the ignition position will change as follows: ACC, ON, OFF.

ACC (Accessory): Provides power to the radio and accessory power outlets. Orange indicator illuminates.

ON: All electrical systems are available. Orange indicator illuminates.

OFF: Power off and indicator off.



STARTING THE VEHICLE

Without Push-button Ignition

To start the engine:

1. Make sure the select lever is in the “P” position (or “N” position and depress the clutch for manual transmission vehicles).
2. Using the key, turn the ignition switch to “START”.

NOTE: Do not depress the accelerator pedal. Release the key as soon as the engine starts.

With Push-button Ignition

To start the engine:

1. Sit in the driver’s seat with the access key fob.
2. Make sure the select lever is in the “P” position or “N” for manual transmission vehicles.
3. Depress the brake pedal (and clutch pedal for manual transmission vehicles).
4. When the Engine START/STOP button indicator turns green, briefly press and release the Engine START/STOP button.

OPERATING THE VEHICLE

DRIVING THE VEHICLE

5-Speed Manual Transmission

The manual transmission is a fully synchronised 5-forward and 1-reverse speed transmission. To shift into reverse gear from 5th gear, you must move the shift lever into neutral then shift into reverse gear.

Automatic Transmission Shift Mode

The Continuously Variable Transmission (CVT) is electronically controlled and provides two different driving modes: normal and manual or normal and low.

Normal Mode

When the select lever is in the “D” (Drive) position, the transmission is in normal shift mode. The select lever position indicator in the Combination Meter Display (CMD) shows “D” and the transmission automatically shifts into a suitable forward gear.

Manual Mode (if equipped)

In manual mode, you select the desired gear position to obtain necessary acceleration and engine braking. Move the select lever left from the “D” position into the “M” position to select manual mode. The gear position indicator in the Combination Meter Display (CMD) shows the currently selected gear. Arrow-shaped indicators show when upshifting or downshifting is available. To shift, use the paddle shift control switches behind the steering wheel.

Low Mode (if equipped)

Low Mode is for using engine braking when going down hill, etc. Moving the select lever left into the “L” position from the “D” (Drive) position causes the transmission to change into Low Mode. The shift position indicator shows “L” as the selected gear.



CVT Select Lever

OPERATING THE VEHICLE

Paddle Shift Control Switches (if equipped)

You can shift gears using the paddle shift control switches. To upshift to the next higher gear, pull the “+” paddle on the right toward you. To downshift to the next lower gear, pull the “-” paddle on the left toward you.

You can temporarily shift gears even when the select lever is in the “D” position by pulling either the “+” or “-” paddle toward you. Once vehicle speed stabilizes, the transmission will switch back to normal mode.



SI-DRIVE (if equipped)

Subaru Intelligent Drive (SI-Drive) has 2 modes: Intelligent (I) and Sport (S). Each mode is designed for different types of driving:

Intelligent:

- The Intelligent (I) mode provides well balanced performance with greater fuel efficiency and smooth driveability without stress. Power delivery is moderate during acceleration for maximum fuel efficiency.

Sport:

- The Sport (S) mode provides the engine power desired by those who want to make the driving experience their own personal adventure.



SI-Drive Switches

OPERATING THE VEHICLE

TURNING OFF THE VEHICLE

Without Push-button Ignition

To stop the engine:

1. Stop your Subaru completely.
2. Move the select lever to the “P” position or set the parking brake for manual transmission vehicles.
3. Turn the ignition switch to “OFF”.

NOTE: The front windows will remain active for about 40 seconds and the SUBARU STARLINK® Multimedia System will remain on for about three minutes or until a door is opened, whichever occurs first.

With Push-button Ignition

To stop the engine:

1. Stop your Subaru completely.
2. Move the select lever to the “P” position or set the parking brake for manual transmission vehicles.
3. Press the ignition switch.

NOTE: The front windows will remain active for about 40 seconds and the SUBARU STARLINK® Multimedia System will remain on for about three minutes or until a door is opened, whichever occurs first.

FUEL FILLER LID

To open the fuel filler lid, pull up the fuel filler lid release lever located on the floor to the left of the driver's seat.

The fuel filler lid is located toward the rear of the passenger side.

While refueling, place the fuel filler cap on the cap holder inside the lid.

After refueling, put the cap back on and turn it clockwise until you hear a clicking noise. Be certain not to catch the tether under the cap while tightening.

To close the lid, press it until you hear it latch.

NOTE: If the fuel filler cap is not tightened until it clicks or if the tether is caught under the cap, the Check Engine warning light may illuminate.



Fuel Filler Lid Release

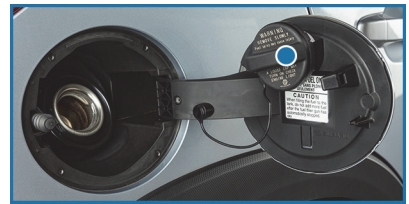

Fuel Filler Lid and Cap

FUEL

Use regular unleaded gasoline with an octane rating of 87 AKI or higher. Do not use fuels with more than 15% ethanol.

 For more information, please refer to the Owner's Manual.

FUEL CAPACITY

	Capacity
Full Fuel Tank	13.2 US gallons
Low Fuel Warning Light	2 US gallons

PASSENGER/CARGO AREAS

FOLDING THE REAR SEATS

First, lower the headrests. Then, pull up on the release knob until you can see the red at the bottom of the knob and fold down the seats.

To return the seatback to its original position, raise the seatback until it locks into place. You will no longer be able to see the red at the bottom of the knob when the seat is locked.



Seat Release Knob

CHILD SAFETY LOCKS

The child safety locks are located on the inside edges of the rear doors. In the locked position, the rear doors can only be opened from the outside.



PASSENGER/CARGO AREAS

LATCH/ANCHOR

Your Subaru is equipped with Lower Anchors and Tethers for Children (LATCH). For maximum safety, first carefully read the LATCH system instructions from the device manufacturer, as well as the installation instructions in your Owner's Manual, to properly install the LATCH compatible restraint system. Use the appropriate seatbelts or anchorages provided in your Subaru. Children age 12 and under must properly occupy the rear seat at all times.

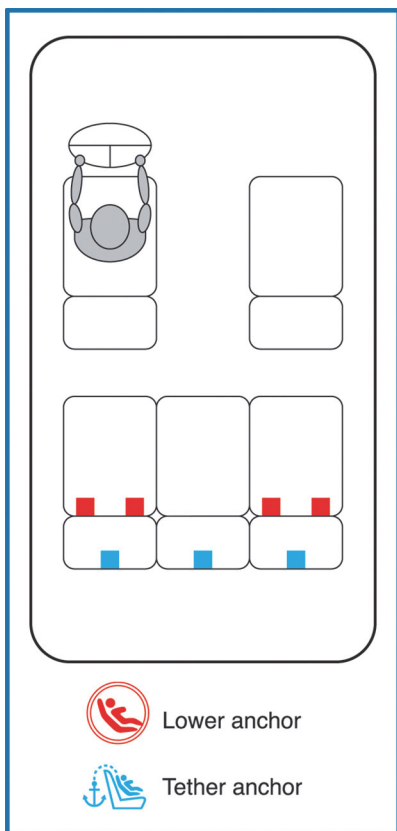

PASSENGER/CARGO AREAS

REAR SEAT REMINDER (if equipped)

The Rear Seat Reminder system assists you in preventing a child or pet from being left in your Subaru. The system monitors the opening and closing of the rear side door. It does not physically sense the presence of a child or pet.

The system turns on if your Subaru is started within 30 minutes of a rear side door opening or closing. It also turns on if a rear side door is opened and closed when your Subaru is running and stationary. The system remains on if your Subaru is turned off and back on again within 30 minutes and the rear side doors remained closed.

When you turn your Subaru off, the system warns you audibly and with a “Reminder, Look in Rear Seat” message in the Combination Meter Display (CMD).

The system operates only one time with each ignition cycle and opening and closing of a rear side door. You can turn the Rear Seat Reminder off in the Combination Meter Display (CMD).



INTERNAL SAFETY TRUNK RELEASE WITH SELF-ILLUMINATING HANDLE (Sedan Models)

In the event that children or adults become locked inside the trunk, this luminescent handle allows them to open the lid from inside the trunk. To open, simply pull the yellow handle as indicated by the arrow on the handle and then push up on the lid.



PASSENGER/CARGO AREAS

TRUNK LID OPENER (Sedan Models)

The trunk release lever is located on the floor to the left of the driver's seat. To open the trunk, pull the lever up and release.



CARGO COVER (5-door Models)

Use the detachable cargo cover to protect contents in the cargo area from direct sunlight. Pull the cover toward the rear of your Subaru and insert both ends of the cover into the guides.



Store the cover under the floor of the cargo area when not in use. Make sure to hook the loops on the floor cover to the hooks in the trim panel to help carry the load of any contents that are stored in the cargo area. Instructions for operation are included on the cargo cover housing.



Cargo Cover and Storage Area

PASSENGER/CARGO AREAS

SPARE TIRE AND JACK

A jack and other maintenance tools are stored in the tool bucket in the center of the spare tire, located under the cargo floor.

Your vehicle is equipped with the following maintenance tools.

- Jack
- Jack handle
- Screwdriver
- Towing hook (eye bolt)
- Wheel nut wrench



 For more information, please refer to “Maintenance Tools” in your Owner’s Manual.

ENGINE COMPARTMENT

HOOD PROP

The hood prop is located in the left front of the engine compartment. Unfold it and insert the end into the slot marked with an arrow.



ENGINE COMPARTMENT

2.0L ENGINE



1 Brake Fluid Reservoir

2 Main Fuse Box

3 Battery

4 Windshield Washer Tank

5 Radiator Cap

ⓘ Please refer to the Warranty and Maintenance Booklet for recommended replacement intervals.

6 Engine Oil Filler Cap

7 Engine Coolant Reservoir

8 Engine Oil Filter

9 Engine Oil Dipstick

10 Air Cleaner Element

ADDITIONAL SPECIFICATIONS

NEW VEHICLE BREAK-IN

The performance and long life of your Subaru are dependent on how you handle and care for your Subaru while it is new.

Follow these instructions during the first 1,000 miles:

- Do not race the engine.
- Do not drive at one consistent engine or vehicle speed, either fast or slow.
- Avoid starting suddenly and rapid acceleration, except in an emergency.
- Avoid hard braking, except in an emergency.

ENGINE OIL

Use 0W-20 synthetic, with one of the following specifications:

- API classification SN or SN PLUS with the words “RESOURCE CONSERVING”.
- ILSAC GF-5, which can be identified with the ILSAC certification mark (Starburst mark).

ENGINE OIL CAPACITY

2.0L Engine

4.7 US quarts (during oil and filter change).

When the level is at the “low” mark, add approximately 1 quart of engine oil in through the filler cap to bring the oil level to the “full” mark. For filler cap location see “Engine Compartment” (p. 44).

- 1 Full Level
- 2 Low Level

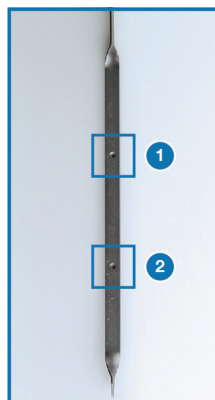

ADDITIONAL SPECIFICATIONS

ROOF RAIL CAPACITY

	CROSS BAR DYNAMIC	ROOF RAIL DYNAMIC	ROOF RAIL STATIONARY
5-Door Models	150 Pounds	176 Pounds	700 Pounds

 For more information, please refer to your Owner's Manual.

TRAILER TOWING CAPACITY

Your Subaru is neither designed nor intended to be used for trailer towing. Therefore, never tow a trailer with your vehicle.

 For more information, please refer to your Owner's Manual.

ADDITIONAL SPECIFICATIONS

TIRE PRESSURE MONITORING SYSTEM (TPMS)

Your Subaru has a Tire Pressure Monitoring System (TPMS). Individual tire pressure can be found in the Combination Meter Display. Use the “i/Set” switch to display the TPMS screen.

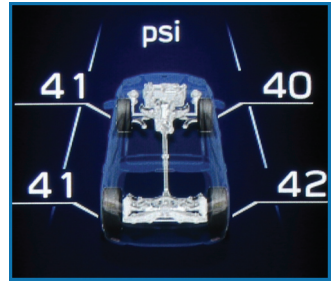

TPMS Screen

Tire pressure specification is on the tire information placard located on the driver's side door pillar.



Tire Pressure Specification Placard

STARLINK OVERVIEW

OVERVIEW OF YOUR MULTIMEDIA SYSTEM

SUBARU STARLINK® Multimedia combines the radio along with the ability to connect your phone* through Bluetooth® to the radio for making calls, sending text messages and listening to your favorite songs that are on your phone.

* Compatible smartphone and application required. For applications to operate, latest version of each application required. Data provided by smartphone is displayed on the Touchscreen. Some state laws prohibit the operation of handheld electronic devices while operating a vehicle. Smartphone apps should only be launched when vehicle is safely parked. Your wireless carrier's rates may apply.

Various Systems

Depending on your model and trim level there are several types of SUBARU STARLINK® Multimedia systems. Some of the functions described in this guide will vary by system.

- 6.5-inch Multimedia
- 6.5-inch Multimedia Plus
- 8.0-inch Multimedia Plus
- 8.0-inch Multimedia Navigation

BUTTONS

Radio Functions

1 Power/Volume Control

Press the power/volume control knob to mute or un-mute the audio. Rotate the knob left to decrease or right to increase the volume.

2 Radio

Press the RADIO button to display the AM/FM/SXM screen. The different tuner modes can be selected by touching the source you want to hear.

3 Media

Press the MEDIA button to display the media sources on the screen. Touch the media source you want to hear. Connected media will display in white.

4 Tune

Rotate the knob to change the channels.

5 Seek

Press the seek up or seek down button to select the next or previous radio frequency. You can also use the seek up or down buttons to select different audio tracks from media sources.



CD Player Functions (if equipped)

6 Load

Insert the disc into the loading slot. The CD will automatically be drawn in and begin playing the first track.

7 Eject

Press the Eject button on the left side of the loading slot to remove the CD from the player.

Other Functions

8 Home

Displays the Home screen apps. The Home screen allows you to customize which apps appear and rearrange the icons in a personalized order.

9 Map (if equipped)

Displays the map and navigation features available on the screen.

10 App

Displays the installed apps that are available on your vehicle. These apps can be rearranged on your Home screen for your preference.

Controlling the Volume

Adjusting the Volume: Turn the VOLUME knob to adjust the volume. The volume stays at the level you set after an ignition cycle.





Muting the Volume: You can mute the audio system by pressing the volume knob once, and un-mute the audio by pressing the knob again. It will un-mute automatically after an ignition cycle.

Turning the System Off: To turn the audio system off, press and hold the volume knob for about three seconds. The system remains off after an ignition cycle. Press the volume knob again to turn the audio system back on.

STARLINK OVERVIEW

TOUCHSCREEN

Operations are performed by touching the screen directly with your finger.

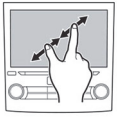
MOTION	ACTION	USE
	Touch Quickly touch and release once.	Changing and selecting various settings
	Double Touch with one finger* Quickly touch and release twice with one finger.	Enlarging the scale of the map screen
	Double Touch with two fingers* Quickly touch and release twice with two fingers.	Reducing the scale of the map screen
	Drag** Touch and drag your finger on the screen to move the screen to the desired position.	<ul style="list-style-type: none">• Scrolling the lists• Scrolling the map screen*
	Swipe** Quickly move the screen by swiping with your finger.	<ul style="list-style-type: none">• Scrolling the lists• Scrolling the map screen*
	Pinch* Move your two fingers further apart (pinch-out) to zoom in on the map. Move your two fingers closer together (pinch-in) to zoom out on the map.	Changing the scale of the map screen

* 8-inch with Navi system only

** The operations may not be performed on all screens.

STEERING WHEEL CONTROLS

- 1 Presets/Skip:** Press to toggle through your preset radio stations or change a track/media file. Press and hold to scan radio stations or fast-forward/rewind media files.
- 2 Volume:** Push the switch up/down to increase/decrease volume.
- 3 Source:** Press to change audio between radio sources and media modes.
- 4 INFO:** Press to operate the Multi Function Display.
- 5 Call/Voice Recognition:** Press to receive/end a call without taking your hands off the steering wheel. Press the talk button to start voice recognition, or press and hold the talk button to initiate Google Assistant or Siri.



Starlink Audio Controls

STARLINK OVERVIEW

VOICE RECOGNITION

With SUBARU STARLINK[®], simple voice commands can control features like navigation, entertainment, phone calls, and, on select models, climate control. A microphone is located in the overhead console; however, you do not need to speak directly into it to activate the voice command features.

 Visit

www.subaru.com/engineering/starlink/multimedia.html for more information.

Press the Voice Recognition "talk" button on the steering wheel to start the voice recognition system. Press and hold the button to cancel the system.

For help with what features are available with voice recognition, press the "Help" button on the screen or press the voice recognition button and say "Help".

Tips

The system may not recognize the voice command due to various types of interference. Some causes for voice command interference are:

- The command is spoken too quickly or at a low or high volume.
- The command is incorrect or unclear.
- The window is open, the climate control system is set on high, or the ventilation is directed toward the microphone.
- Passengers are talking while the command is spoken.

In some cases, you may not be able to use voice commands if the system cannot properly recognize the command. For example, the command is incorrect or unclear.

NOTE: The system is designed to recognize a variety of commands, but certain words, accents or speech patterns may be difficult for the system to recognize.

Google Assistant: May not work with all devices or may not be compatible with the audio system.

Siri Eyes Free: Press and hold the Voice Recognition Button when your phone is connected via bluetooth for Siri Eyes Free.



Scan to learn more
about **Subaru
Multimedia.**

STARLINK OVERVIEW

Common Commands

Below are examples of common commands that can be used with the voice recognition system. Please refer to your SUBARU STARLINK® Owner's Manual for a complete list.

VOICE COMMAND	FUNCTION	EXAMPLE
Dial [Number]	Places a call to the phone number	Dial 555-123-4567
Call [Name] [Phone Type]	Places a call to the contact name and phone type of the contact from the phonebook	Call John Doe mobile
Navigate to [House Number, Street, City, State] ¹	Sets a destination to the address	Navigate to 1234 Main Street, Lincoln, Washington
Show Map ¹	Displays the map screen	Show Map
Where am I ¹	Displays current location on map	Where am I
Tune to [Frequency] (AM / FM)	Switches to AM/FM and tunes to spoken frequency	Tune to 99.5 FM
Preset [Number]	Switches to the preset channel	Preset 3
Satellite Channel [Name / Channel Number]	Switches to satellite channel number	Satellite Channel Prime Country 55
Set Fan Speed to [1-7] ²	Sets the fan speed to the spoken fan speed	Set fan speed to 4
Set Temperature to [Number] ^{2,3}	Sets the temperature to the spoken temperature	Set temperature to 70
Help	Changes to help screen	Help
Phone Help	Displays a list of voice commands related to controlling your phone	Phone Help
Media Help	Displays a list of commands related to the media	Media Help
Radio Help	Displays a list of commands related to the radio	Radio Help
Navigation Help ¹	Displays a list of voice commands related to navigation	Navigation Help

1 8.0-inch Multimedia Navigation system only

2 8.0-inch Multimedia Plus and 8.0-inch Multimedia Navigation system only

3 When the A/C is off, the A/C setting will not change even if the voice command is accepted

STARLINK HOME

HOME SCREEN ICONS

Phone – Allows you to place and receive calls and text messages.

Map – Allows you to enter a destination and have route guidance to get you where you are going.

Settings – Allows you to change the settings to your personal choice for select systems inside the vehicle.

Add Shortcut – Allows you to add icons for various functions to the home screen.

Apps – Entertainment and convenience applications that can be used to enhance your driving experience. The apps included are: MySubaru, Pandora®, Travel Link®, Android Auto™, SUBARU STARLINK®, aha™, and Apple Car Play®.

Media – Allows you to play CDs, USB/iPod music, or Bluetooth® audio by connecting to the device.

Radio – Allows you to select a station to listen to as well as pause and playback live radio.

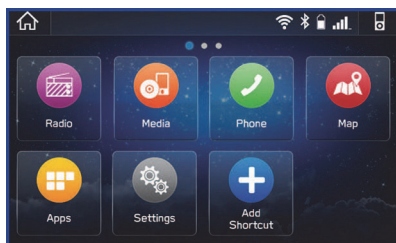

Home Screen Icons



Scan to learn more
about

SUBARU STARLINK®.

REARRANGING ICONS

You can rearrange the icons on the Home Screen when the Home Screen Shortcuts function is turned on. You can turn on the Home Screen Shortcuts function by selecting “Settings”, then the “General” tab.

To rearrange icons on the Home Screen:

1. Select and hold the shortcut icon you want to move.
2. Drag the icon to the desired position and release.
3. To delete an icon, drag the icon to the bottom of the screen and release.

ADDING SHORTCUTS

You can add shortcut icons for various functions to the Home Screen when the Home Screen Shortcut function is turned on. You can turn on the Home Screen Shortcuts function by selecting "Settings", then the "General" tab.

To add shortcut icons to the Home Screen, press the "Home" button.

1. Select "Add Shortcut".

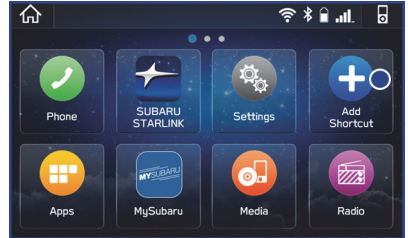

2. Select the desired function.

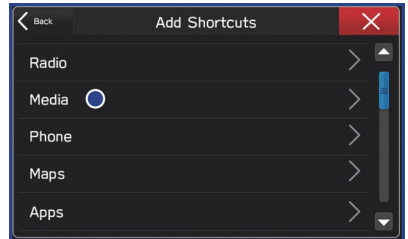

3. Select the desired shortcut function.
4. Check that the shortcut icon is displayed on the Home screen.

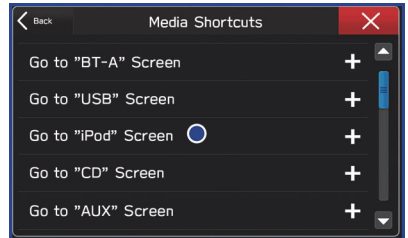

DRIVER PROFILE

CREATING A DRIVER PROFILE

Creating a Driver Profile provides many benefits beyond just pairing a phone. The profile records and remembers station presets, sound preferences, home and work address (if equipped with navigation), phone favorites, screen icons and placement, and the background wallpaper.

To create a driver profile:

1. From the Home screen, select “Settings” then “Driver Profile”.

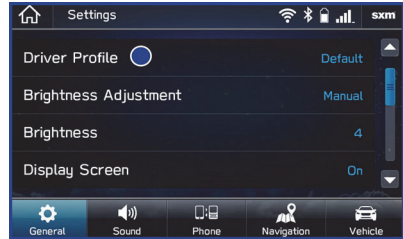

2. Select “Add New Profile”.

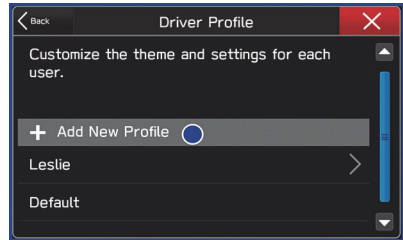

3. Select “Enter Name” to display the keyboard screen then type your name. Now touch “Next” on this screen and the following screen.

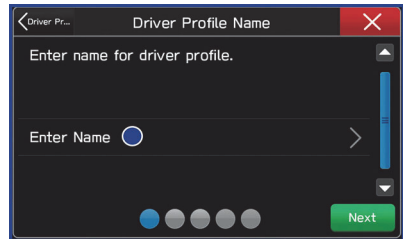

DRIVER PROFILE

4. Select a paired phone or pair a new phone (see step-by-step directions to pair a phone in the How To Appendix). Then select “Next”.

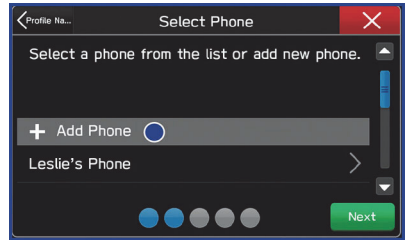

5. Enter a Home Address and Work Address (if equipped with navigation). Then select “Next”.

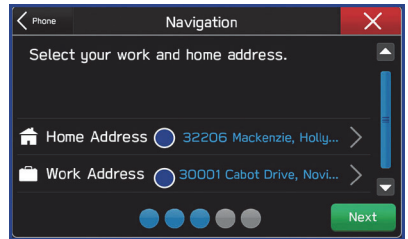

6. Select a Wallpaper then select “Next”.
7. Select “Finish”.



Retrieving a Driver Profile

The system automatically retrieves the profile once you are in your Subaru with the radio on and your phone's Bluetooth® active. You can also manually retrieve or change the profile by following these steps:

1. Press the “Home” button and then select “Settings”.
2. Select “Driver Profile” and then select the profile you want to use and finally select “Back”.

MULTIMEDIA

RADIO

AM/FM Radio

Your Subaru is equipped standard with AM/FM radio which includes HD Radio®. HD Radio® technology allows you to receive digital broadcasts (where available) in addition to analog broadcasts. Digital broadcasts provide free, crystal clear audio with no static or distortion.

Visit www.hdradio.com for more information and a guide to available radio stations and programming.



Scan to learn more about HD Radio.

Satellite Radio

A SiriusXM® Satellite Radio is a tuner designed exclusively to receive broadcasts provided under a separate subscription. After a free trial period, a subscription is necessary to continue service.

For more information or to subscribe, visit www.siriusxm.com.



Presets

You can preset 18 stations. Presets can be set for SiriusXM®, FM, or AM stations, allowing you to switch among the three with the press of a single button. To preset a radio station:

1. Tune to the desired channel.
2. Press and hold the desired preset station button at the bottom of the screen.



Scan to learn more about
SiriusXM Radio.



MULTIMEDIA

MEDIA

Bluetooth®

Your Subaru has Bluetooth® hands-free technology to manage your phone and audio systems. Bluetooth®-enabled mobile phones link directly through your Touchscreen automatically once connected. Bluetooth® Hands-free allows you to receive and initiate calls, or play music directly from your device while keeping it stowed for safety.

For step-by-step instructions on how to pair a Bluetooth® device to the Touchscreen, please see page 98 for Android devices or page 102 for Apple devices. A QR code and link to more information on pairing a Bluetooth® device can also be found on page 61.

CD (if equipped)

The CD player holds a single disc. To access the CD menu, put a CD in the player or touch the CD icon on the “Media” Screen. Depending on the CD format, the CD album art work may appear on the Touchscreen.

USB / iPod

You can plug in a USB memory storage device or iPod into the USB ports. This will bring up the media screen with controls. If using an iPod, make sure to use an Apple certified cable or MFi certified cable for proper operation.

Aux Input

The Aux jack is a port that allows input from an audio device such as MP3 players, portable music players, and iPods. To access the Aux menu, plug in the device to the Aux jack and the menu will appear, or select the Aux menu from the “Media” Screen.

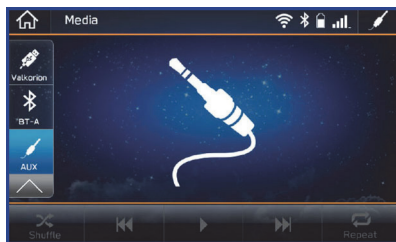

PAIRING A PHONE

To begin using your Bluetooth® Hands-free device you must first pair your phone with the system. Phone pairing provides access to the contact list on your phone and allows you to use the voice recognition system to make and receive calls. The system can also read incoming text messages, as well as allowing you to reply to texts or send short messages. The system automatically reconnects to your Bluetooth® device and will remember your driver profile.

For instructions on how to pair your phone to the Touchscreen, see page 98 for Android devices or page 102 for Apple devices.

Visit <https://www.subaru.com/owners/index.html> for complete details on what is available by connecting a phone to the Touchscreen.



Scan to learn more about **Pairing a Phone**.

MAKING A CALL

You can make a call through voice recognition by touching the “Voice Recognition Switch” on the steering wheel to start or stop the voice recognition system. After pressing the “Voice Recognition Switch”, wait for the “Voice Guidance” screen to appear on the Touchscreen and say “Call [name and phone type]” or “Dial [number]”.

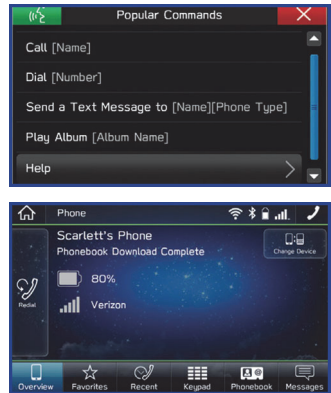

To make a call from the Touchscreen, start by pushing the “Home” button and then select “Phone”. After the phone screen displays, select the method you would like to use to make a call.

- Overview – Allows you to call the last number.
- Favorites – Allows you to place a call to one of your favorites on your phone.
- Recent – Allows you to call someone that has recently called you or that you called.
- Keypad – Allows you to dial any number you would like.
- Phonebook – Displays the phonebook from your phone.

PHONE

RECEIVING A CALL

To receive a call, press the “Talk Switch” on the steering wheel or the “Talk Button” on the Touchscreen.

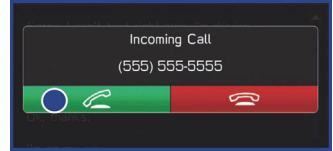

To reject a call, press the “End Switch” on the steering wheel or the “End Button” on the Touchscreen.

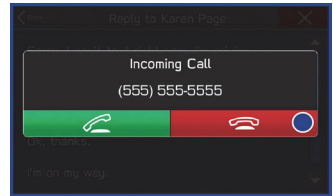

TEXT MESSAGES

Received messages can be forwarded from the connected Bluetooth® phone, enabling checking and replying using the system.

Depending on the type of Bluetooth® phone connected, received messages may not be transferred to the message inbox. If the phone does not support the message function, this function cannot be used.

Depending on the Bluetooth® phone type, the screen display may differ, and it may not be possible to use certain functions.

To use this function, it is necessary to set the phonebook download function to ON. When a Short Message Service (SMS)/ Multimedia Messaging Service (MMS) is received, the incoming message screen pops up with sound and is ready to be retrieved using the Touchscreen. Select “Play” to listen to the message or “View” to see the message on the screen. This button may not be available if the vehicle is moving.

If there is more than one unread message, a screen will appear allowing you to either view your inbox or ignore the message.

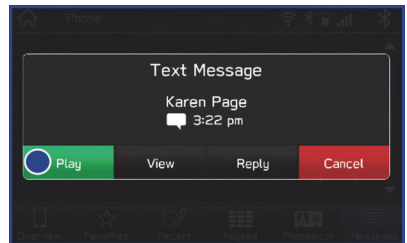

APPS

SUBARU STARLINK® IN-VEHICLE APPS

SUBARU STARLINK® Multimedia offers advanced connectivity through Apple CarPlay®, Android Auto™, and Pandora® apps. Wireless pairing and hands-free smartphone operation allow for safe and easy connection to your favorite apps and content. You can access news, navigation, music, podcasts, and more through the available SUBARU STARLINK® app.

For a complete list of all the apps available, visit www.subaru.com/engineering/starlink/multimedia.html.



Scan to learn more about **Subaru Multimedia**.

aha™ by HARMAN

aha is a cloud-based application that connects to the system and gives you access to your favorite web content safely and easily. There are thousands of available stations spanning internet radio, personalized music, audiobooks, Facebook, Twitter, restaurant and hotel searches, weather and more. For more about aha, visit www.aharadio.com.

To use the aha application, connect your iPhone or Android device via Bluetooth®. When connecting an iPhone or Android device with the aha application installed, you can control, view, and hear aha content through the system.

With the 8.0-inch Multimedia Navigation function, you may also display Points Of Interest (POI) information from the aha application on the map screen and route to these POIs.

Pandora®

Pandora is a free, personalized radio that offers effortless and endless music enjoyment. To use the Pandora application, first install the Pandora application on your smartphone. Then connect your iPhone or Android device via Bluetooth®.

NOTE: Some vehicles might be incompatible with this app depending on difference between models and software version.



Scan to learn more about **aha radio** or **to get the app**.

Android Auto™

Android Auto can be used to view maps, play music, and place calls by connecting your Android device to the system. You can also run supported applications. To use the Android Auto application, connect your Android device to the USB port.

 For more information on connecting your phone, please refer to page 106.

For details on services or operations, visit the Android Auto sites www.android.com/auto/ or www.support.google.com/androidauto/.



Scan to learn more about **Android Auto**



Scan to learn more about **Android Auto Help**

Apple CarPlay®

Apple CarPlay can be used to view maps, play music, and place calls by connecting your iPhone to the system. You can also run supported applications. To use the Apple CarPlay application, connect your iPhone to the USB port.

 For more information on connecting your iPhone, please refer to page 109.

For details on services or operations, check the Apple CarPlay site www.apple.com/ios/carplay/.



Scan to learn more about **Apple CarPlay**

SiriusXM® Travel Link

SiriusXM® U.S. satellite and data services are available only in the 48 states of the contiguous USA and DC.

Data service information, which is comprised of sports, weather, stocks and fuel prices, can be received via the SiriusXM® Radio, with the option to turn on or off weather alerts.

To receive the data service information in the vehicle, a subscription to the SiriusXM® Satellite Radio Service is necessary following a free trial.

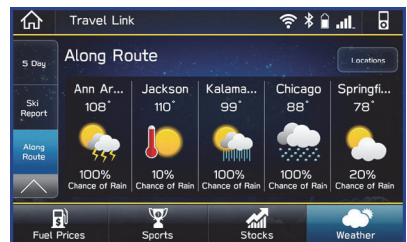

APPS

SUBARU STARLINK® MOBILE APP

There are several key applications that can be loaded to your phone and used while in your Subaru to help you while you drive. You must also download and log in to the SUBARU STARLINK® app on your phone to use these apps.

To download the SUBARU STARLINK® app, go to the Apple App Store or the Google Play Store and search for SUBARU STARLINK® in the menu.

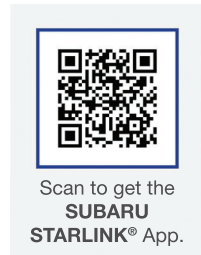
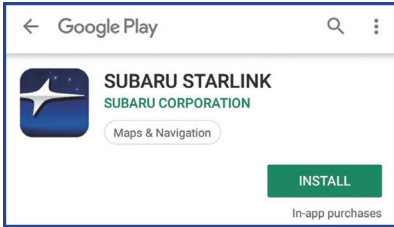

Below are a few apps that you may find helpful.

Getting Started Guide Information

This is the digital version of the original printed Getting Started Guide that is standard in all new Subaru vehicles. The app features In-Vehicle Help (IVH) that provides an interactive, searchable, model-specific concierge through the Touchscreen.

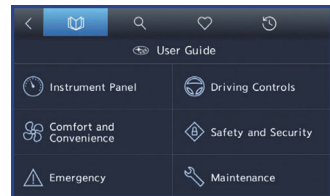
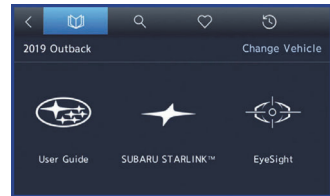

Yelp

Yelp is a local guide powered by a community of reviewers that helps you find great local businesses.

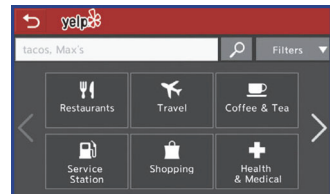

Chimani

Get the most comprehensive guide to all 417 national parks in the United States. Quickly learn about each park's history and highlights.

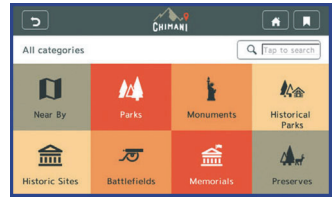

eBird

Exclusive to Subaru vehicles, the eBird app tells you what birds are being seen near you in real time. Based on a database of millions of bird sightings, eBird acts as a "digital coach" for finding birds. Use the app to decide where to go based on the distance to a great birding location and the species being seen there. For example, the app may tell you the nearest sighting of a certain species is 8 miles away and navigate you to the last place it was seen. Full-screen photos help you confirm your sightings.

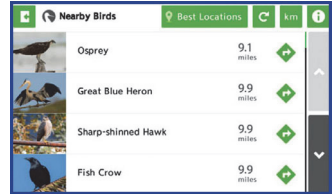
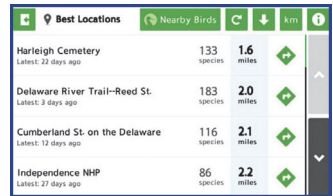

APPS

MYSUBARU

Whether you're on the road or planning adventures, the MySubaru app makes loving every part of owning your Subaru easy. Although the mobile app is great when you are on the go, you can also visit www.MySubaru.com from your computer to access the same functions and to aid in planning your trip before you leave.

You can download the MySubaru app from the Google Play Store or the Apple App Store on your phone by searching MySubaru.

By creating an account, you can:

- Schedule service with a preferred Subaru retailer
- Get vehicle service reminders, recall alerts, and exclusive coupons
- Track and record your service history
- Access resources like your owner's manuals, how to videos and more
- Have access to SUBARU STARLINK® Safety and Security features (must have an active SUBARU STARLINK® subscription)
- Get help from 24-hour roadside assistance (24-hour roadside is included in standard 3-year warranty, and after 3 years with a Concierge package)



Scan to get the
MySubaru App.

Service Appointment Scheduler

The SUBARU STARLINK® Service Appointment Scheduler can help you set an appointment from the MySubaru website, Mobile App or the vehicle's Touchscreen. Getting your Subaru vehicle to the Subaru professionals for service is easy, no matter where you are. If you are away from your preferred Subaru retailer for service, you can always use Service Appointment Scheduler to locate any of our certified Subaru retailers near your location.

STARLINK® Service Appointment Scheduler on your Touchscreen is a convenient way to set a service appointment. Simply select the MySubaru icon on the home screen and choose "Make an Appointment" to get started.

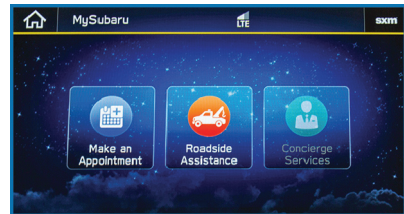

CREATING HOME AND WORK PROFILES

You can create a driver profile that includes your home address and work address through the “Settings Menu”. A detailed process on how to do this can be found on page 56.

FINDING A DESTINATION

You can use the navigation system to find a destination by address or by Points Of Interest.

Finding a Destination by Address

To search by address:

1. Start by pushing the “Map” button to display the map screen. Then touch “Menu”. Next select “Search by Destination Enter Address”.



2. The keypad screen displays. As you type the address or name of the destination, suggestions will display. Touch the desired destination.



3. The route calculation screen displays three recommended routes at the bottom left of the screen. Select the desired route, then touch “GO”. You can also press and hold the route on the map to begin navigation.

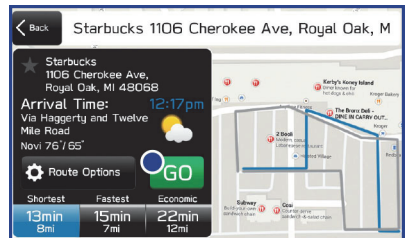

MAPS (if equipped)

Finding a Destination by POI

To search by Points Of Interest (POI):

1. Push the “Map” button to display the map screen. Then, touch “Menu”, followed by “Nearby Places List of POI”.

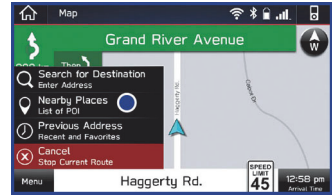

2. Categories are listed alphabetically. Use the scroll bar on the right, if needed, to display more categories, then make your selection.

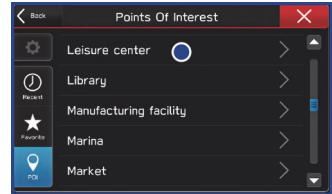
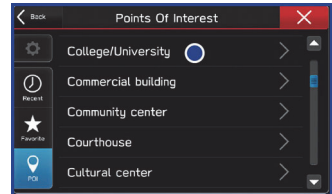

3. Select the desired item from the list, then touch “GO”.

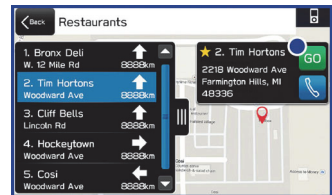

4. The route calculation screen displays three recommended routes at the bottom left of the screen. Select the desired route, then touch “GO”. You can also press and hold the route on the map to begin navigation.

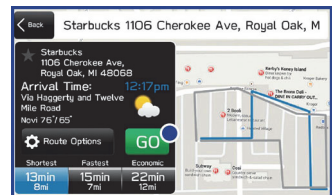

Route Options

You can set the navigation system to avoid various types of routes:

1. Select “Route Options” on the route calculation screen.
2. Select the desired item to avoid.
3. Select the check mark in the upper right corner.

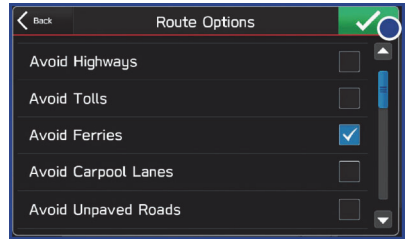

NOTE: The avoidance criteria for the route calculation can also be set from the navigation settings screen.

Shortest/Fastest/Economic

You can set the route preferences to search for the shortest, fastest, or most economic route. To do this:

1. Touch “Settings” from the Home screen.
2. Select “Navigation”.
3. Select “Route Settings”.
4. Select the preference you would like to use: Shortest, Fastest, or Most Economic.



Saving Destination as a Favorite

Registered points can be set as a destination. To save a location as a favorite once you have arrived:



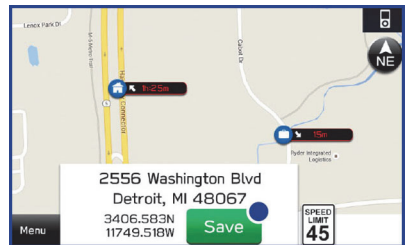













1. Select the current street name.
2. Select “Save”.
3. Select to save as Home, Work, or Favorite.



MAPS (if equipped)

Guidance Screen Icons

The Guidance Screen Icons are the common icons used for the navigation guidance:

ICON	EXPLANATION	ICON	EXPLANATION
	Turn left.		Stay in the left lane.
	Turn right.		Stay in the right lane.
	U-Turn Left.		Straight ahead at the intersection.
	U-Turn right.		Turn left at the T junction.
	Keep left at the fork in the road.		Turn right at the T junction.
	Keep right at the fork in the road.		Go left at the roundabout.
	Turn left & sharp curve.		You are half way to your destination.
	Turn right & sharp curve.		You have arrived at your destination.

Map Zoom

Once on the map screen, you can zoom in or out by touching the “+” or “-” buttons on the screen. You can also use two fingers on the screen and move them apart to zoom in or together to zoom out.

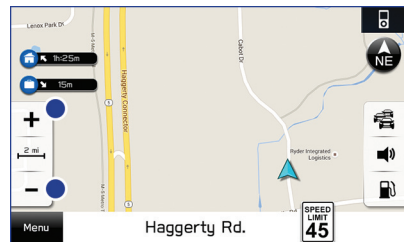

MAPS (if equipped)

Map View/Perspectives

The perspective of the map can be changed between 2D north-up, 2D heading-up, and 3D. To change the view, select the icon at the upper right of the screen. Each time the icon is touched, the view will change as well as the icon to match the map perspective.

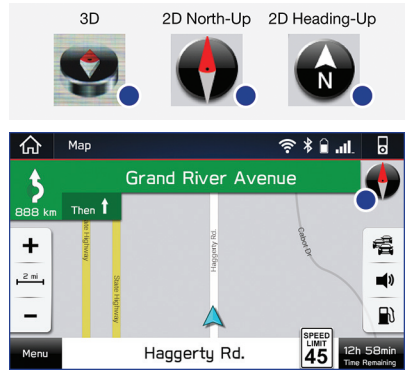

Traffic Information

Road sections affected by traffic conditions are displayed in a different color on the map, and a small icon representing the type of traffic condition is displayed above the road.

A subscription to the SiriusXM[®] Satellite Radio Service is necessary to receive the data service in the vehicle (3 years included).

MAPS (if equipped)

Nearest Gas Station

To find the nearest gas station, select any point on the map and then select the fuel icon in the lower right corner.

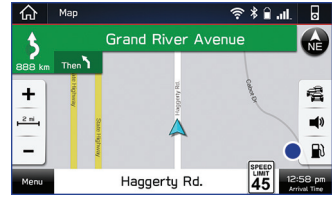

When driving on the highway during route guidance, information on gas stations, restaurants, or rest areas near the next three highway exits will be displayed.

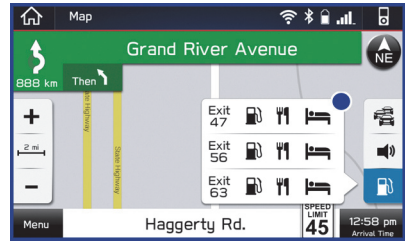

Select the desired item from the list, and then select "GO" to navigate to the closest selected place.

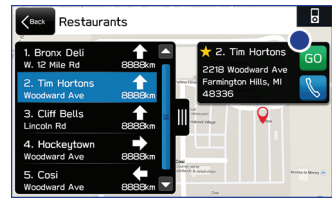

Arrival Time/Distance

Displays the distance to the destination, the estimated travel time to the destination, or the estimated arrival time at the destination. Select the information box in the lower right corner to change between modes.



Canceling Guidance

To cancel guidance, select "Menu" and then select "Cancel".

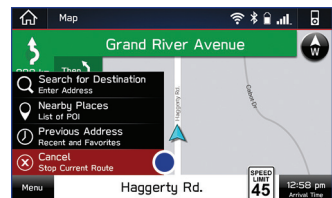



STARLINK SAFETY AND SECURITY

SAFETY AND SECURITY OVERVIEW

STARLINK® Safety and Security services* are designed to help in your time of need. These include Advanced Automatic Collision Notification, SOS Emergency Assistance, Enhanced Roadside Assistance, Stolen Vehicle Recovery, the added convenience of Remote Engine Start with Climate Control, and so much more.



With the SUBARU STARLINK® system integrated into your vehicle, advanced safety and security technology is just a button press away. The SUBARU STARLINK® experience includes in-vehicle call center support, maintenance and diagnostic alerts as well as remote services that keep you connected to your Subaru vehicle.

Located in the overhead console of most Subaru vehicles are the red SOS  and blue i-button . Both buttons link you to the SUBARU STARLINK® call centers that are there to support you 24 hours a day, 7 days a week.

The SOS button  is for SOS Emergency Assistance.

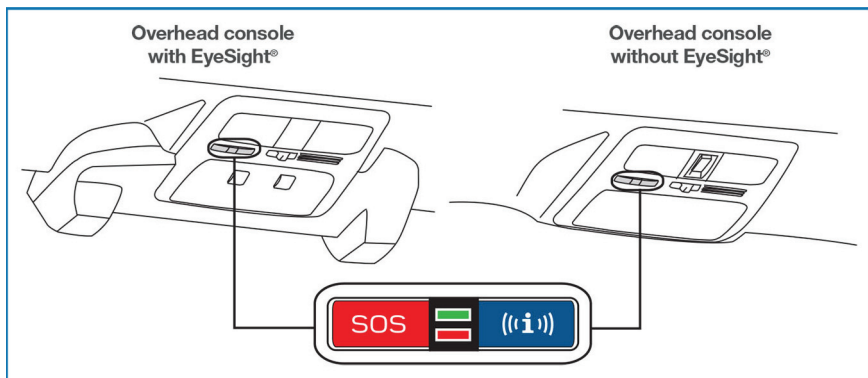
The i-button  is for Enhanced Roadside Assistance or Concierge (if subscribed).



- Press the SOS button  for SOS Emergency Assistance.*
- Press the i-button  for Enhanced Roadside Assistance* or Concierge* (if subscribed).*
- To cancel a SOS Emergency Assistance, Enhanced Roadside Assistance or a Concierge call, press and hold the same button for approximately two seconds or select the “End Call” button if displayed on the Touchscreen.

Head to www.Subaru.com/STARLINK to see all the SUBARU STARLINK® subscription services and packages.

* Access to STARLINK® Safety and Security services requires an active STARLINK® subscription. Remote Engine Start available on keyless access with push-button start vehicles. Remote Engine Start with Climate Control available on vehicles with keyless access with push-button start and automatic climate control. Not available on vehicles with manual transmission.



Scan to learn more
about **SUBARU**
STARLINK.

STARLINK SAFETY AND SECURITY

ENROLLMENT

To enroll in SUBARU STARLINK[®] and access remote services, a MySubaru account is required. MySubaru is the Subaru owner website that allows you to access vehicle remote services, user preferences, diagnostic alerts and other useful features enabled by your STARLINK[®] Safety Plus, STARLINK[®] Security Plus and STARLINK[®] Concierge subscription.

Your retailer may have created an account for you during the delivery process. However, you can also create a MySubaru account on www.mysubaru.com.

Enrollment in SUBARU STARLINK[®] can be done online at MySubaru.com, through the MySubaru Mobile App, at your Subaru retailer or by calling a STARLINK[®] Customer Care Representative at:1-855-753-2495

NOTE: Please have your Vehicle Identification Number (VIN) available, as you will need it to complete this step. After the enrollment process, you will learn more about the features in detail at MySubaru.com.

MYSUBARU INTEGRATION

The connection between you and your Subaru has never been simpler, and the MySubaru website (MySubaru.com) and MySubaru Mobile Application are the best ways to stay in touch with your Subaru vehicle. From MySubaru, you can access the following information and STARLINK[®] Safety and Security services*:

- Remote Services
- Vehicle Health
- Usage Reports
- Service Appointment Scheduler
- Vehicle Maintenance Schedules
- Service History
- Support Resources

* Internet access is purchased separately through AT&T with monthly, per gigabyte, and unlimited data options available. Existing AT&T customers have the option to add an additional line to their AT&T Mobile Share plan. Available on select models.

STARLINK SAFETY AND SECURITY

SUBARU STARLINK® WI-FI HOTSPOT

SUBARU STARLINK® in-vehicle Wi-Fi Hotspot keeps you and your family connected using AT&T's 4G LTE nationwide cellular network. Whether watching movies, playing games or even listening to music, your family won't miss a beat with SUBARU STARLINK® in-vehicle Wi-Fi Hotspot. Set up is quick and easy and you don't need a SUBARU STARLINK® subscription to use it:

1. Select "Settings" from the Home screen.
2. Select "Wi-Fi Hotspot" to turn it on (if the Wi-Fi Hotspot is already on then proceed to the next step).
3. Select Wi-Fi Hotspot Settings to view or update the following settings:
 - Wi-Fi Network Name (SSID)
 - SSID Broadcast (Network ON / OFF)
 - Security Type (WPA / WPA2)
 - Password
 - Connected Devices (Maximum of 8 devices)

How to enroll:

1. Connect your tablet, smartphone or laptop to the SUBARU STARLINK® Wi-Fi Hotspot network listed in the settings menu and open your preferred web browser on the device connected.
2. Once the SUBARU STARLINK® Wi-Fi Hotspot homepage loads, follow the on-screen instructions to create a new account or to add your vehicle to an already existing AT&T Wireless account. You can also subscribe to the Wi-Fi Hotspot from the MySubaru website or Mobile App.

* Internet access is purchased separately through AT&T with monthly, per gigabyte, and unlimited data options available. Existing AT&T customers have the option to add an additional line to their AT&T Mobile Share plan. Available on select models.



Scan to learn
more about **AT&T**
Wi-Fi Hotspot

SETTINGS AND UPDATES

GENERAL

Many settings can be customized for different features in your Subaru. In this section you will find examples and instructions for some of the settings you can tailor to fit your preferences, as well as ways to keep your system updated.

For the 8.0-inch Multimedia Plus and the 8.0-inch Multimedia Navigation systems, the system software can be updated via a Wi-Fi network or using the aha application on your smartphone (depending on your smartphone communication and transfer speed). The update process involves downloading and installing the software update. You can also ask your preferred Subaru retailer to update the system software.

Connect to Home Wi-Fi

You can connect your SUBARU STARLINK® Multimedia system to your home Wi-Fi to update the software and maps. To connect to Wi-Fi, first go to the “Settings” screen, select the “General” tab, and then select “Wi-Fi Settings”.

Next, select the desired network and then select “Connect”. If the network is a secure network, enter the password and select “Join”.

You will get a notification on the screen when the connection is complete. If an error message appears, follow the guidance on the screen to try again.

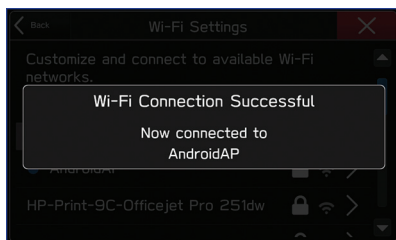
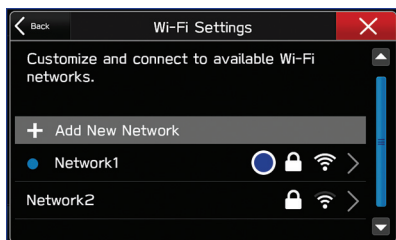
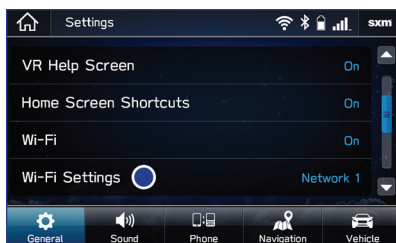

 For more information, please refer to page 110 or your STARLINK® Owner's Manual.

SETTINGS AND UPDATES

Performing Software Updates

Software updates provide enhancements to the system such as new features, added security, and upgraded functions.

To check for updates, you first need to connect to a Wi-Fi network.

1. Connect to a Wi-Fi network or start the aha application on your smartphone.
2. Next, display the general setting screen. Then select “Check for Updates”. If an update is available, select “Download Now” to begin the download.
3. Once the download is finished, select the “Install Now” button to start the installation. After the installation is complete, select “I Agree” on the confirmation message to complete the update processing. The system will restart automatically.

NOTE: System functionality will be restricted during installation.

 For detailed step-by-step instructions and more information, please refer to page 111 or your STARLINK® Owner’s Manual.

SOUND

To change the sound settings, press the “Home” button, then select “Settings”, and then select “Sound”. Choose the setting you want to change.

SETTING	FUNCTION
EQ and Sound Position	Select to set sound settings.
Surround	Select to turn the surround on/off.
Entertainment Volume	Select to set audio volume.
Aux Volume Gain	Select to set AUX volume gain.
Microphone Volume	Select to adjust the mic sensitivity. This adjusts the speaker’s voice during hands-free communication.
Navigation Volume	Select to set the navigation prompt volume. (Navigation-equipped vehicles only).
Phone Volume	Select to adjust the default volume of the other party’s voice.
Ringtone Volume	Select to adjust the ringtone volume.
Speech/VR Volume	Select to set the voice recognition prompts volume.
Alert Sounds	Select to turn the Alert Sound on/off for traffic, weather, or SXM game information updates.
Beep Sounds	Select to turn the sound beeps on/off.
Speed Volume	Select to set the speed volume. The system adjusts to the optimum volume and tone quality according to vehicle speed to compensate for increased vehicle noise.

SETTINGS AND UPDATES

PHONE

The hands-free system lets you make and receive calls without taking your hands off the steering wheel.

This system supports Bluetooth®, a wireless data system. In the settings menu, you will be able to change the microphone volume, ringtone, and phone volume.

To access the phone screen, press the "Home" button, then select "Phone" or press the "Phone" button.

MAPS/NAVIGATION

There are many programmable map/navigation features that can be customized. These settings are located under the "Settings" menu and then "Navigation". Listed in the table below are some common settings you can customize for your convenience.

SETTING	FUNCTION
Route Setting	Allows you to select Fastest, Shortest or Economic.
Avoid	Allows you to avoid things like highways, tolls, ferries, carpool lanes and unpaved roads.
Map Display	Allows you to change the brightness by selecting auto, day or night.
Save as Home	Allows you to input your home address.
Save as Work	Allows you to input your work address.
POI Icons	Allows you to turn the icons on/off.
Arrival Time	Allows you to select either 12 hour time or 24 hour (military) time.
Auto Zoom	Allows you to turn on/off.
Rest Stop Guidance Function	Allows you to turn on/off.
Low Fuel Warning	Allows you to turn on/off.

SETTINGS AND UPDATES

Checking for Updates

You can update the maps to the latest information. The maps should be checked and updated regularly for the best possible navigation experience.

The maps can be updated over the air or with a USB memory device. When updating over the air, you are limited to updating eight regions at a time. This allows you to update your home state without having to download the entire map program for the United States. This option is great if you normally stay in your home state and/or surrounding states.

Updating Over-the-Air

To check for available updates over the air:

1. Connect to a Wi-Fi Network (see page 110).
2. Select “Map Update” on the navigation settings screen.
3. Select “Select Region (Max of eight)”.
4. Choose up to eight regions to update by selecting the box for the regions (States) you want to update.
5. Select “Back”, then select “Check for Updates”.

You will get a screen if updates are available. From there, choose either “Yes”, “Select Region(s)”, or “Cancel”.

Updating using your PC/MAC

Maps can also be updated using a USB memory device, which will allow the entire map program to be updated at one time. This is a great option if you are going to take a cross-country trip and your maps have not been updated in a while.

To update the map using a USB memory device, start by going to www.subaru-maps.com



Scan to learn
more about
Map Updates

CLOCK

The clock can be set manually or automatically. When set to “Auto”, the clock automatically adjusts when a Bluetooth® connected phone is paired (vehicles without navigation), or through the GPS signal (vehicles with navigation system).

SETTINGS AND UPDATES

Manually

Use the STARLINK® Touchscreen to set the clock:

- 1 Press the “Home” button.
- 2 Select “Settings”.
- 3 Select “Vehicle”.
- 4 Select “Time/Date”.



- 5 Select “Mode”.

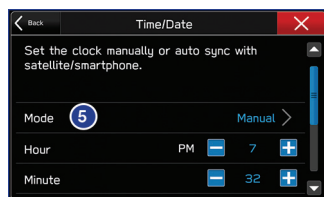

- 6 Select “Manual”.

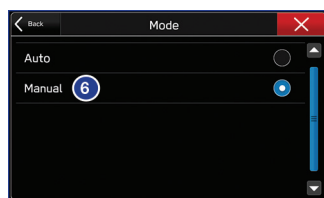

- 7 Now adjust the time and date using the “+” and “-” buttons.

For black-and-white Multi-Function Display (MFD), use the “+” and “-” buttons next to the clock.

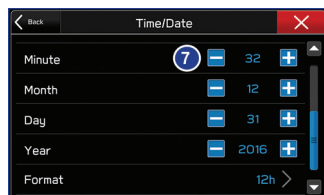

SETTINGS AND UPDATES

Automatically

To set the clock automatically, the “Auto” mode must be selected in the clock adjustment setting. To set the clock:

- 1 Press the “Home” button.
- 2 Select “Settings”.
- 3 Select “Vehicle”.
- 4 Select “Time/Date”.



- 5 Select “Mode”.

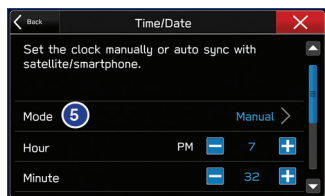

- 6 Select “Auto”.

The clock automatically adjusts as follows:

- Systems with Navigation: Automatically adjusts the clock when a GPS signal is available.
- Systems without Navigation: Automatically adjusts the clock when a phone is paired and connected via Bluetooth®. “Phonebook Download” must be enabled in the Phone Settings.

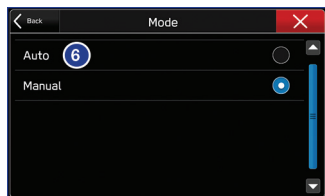

For step-by-step procedure to pair a phone to the SUBARU STARLINK® Touchscreen, see page 98 for Android devices or page 102 for Apple devices.

EYESIGHT

EYESIGHT® OVERVIEW

Your Subaru features a variety of safety systems that are the culmination of everything Subaru Engineers know about safety. These systems are referred to as “Driver Assist Technologies” and add confidence to every trip you and your passengers take. Working together, these systems provide enhanced awareness, safety, and convenience in front, to the sides, and behind your Subaru. Subaru Driver Assist Technologies include:

- EyeSight® Driver Assist Technology
- Rear-Vision Camera
- Pre-Collision Braking
- Blind-Spot Detection (BSD)
- Rear Cross-Traffic Alert (RCTA)
- Reverse Automatic Braking (RAB)
- High Beam Assist (HBA)
- Lane Keep Assist (LKA)
- Steering Responsive Headlights (SRH)

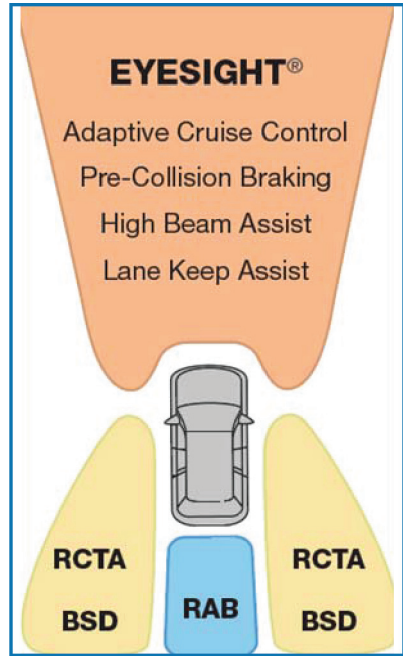

OPERATION

EyeSight® is a driver assist technology that uses dual color cameras to serve as an extra pair of eyes on the road ahead to identify vehicles in front, pedestrians, traffic lanes, or other objects. If need be, the EyeSight® system can apply the brakes and/or reduce engine power to help avoid or reduce the severity of a collision. During these events, the system will provide audible and visual alerts to assist you in making decisions.

Since the characteristics and limitations of the EyeSight® color cameras are similar to human eyes, it is important that the cameras, windshield, and area in front of the cameras are treated with special care. For more information, please refer to “Care and Limitations” on page 95 for more details.



EyeSight Cameras (inside)



EyeSight Cameras (outside)

FUNCTIONS

The EyeSight® system features several distinct functions designed to provide extra awareness, improve safety, reduce fatigue, and add peace of mind every time you drive your Subaru. EyeSight® functions include:

- Pre-Collision Braking
- Pre-Collision Brake Assist
- Pre-Collision Throttle Management
- Lane Departure Warning
- Lane Sway Warning
- Lane Keep Assist
- Adaptive Cruise Control
- Conventional Cruise Control
- Lead Vehicle Start Alert

Pre-Collision Braking

This function helps prevent or minimize a frontal collision with another vehicle, pedestrian, or other objects by providing visual and audible warnings. Warnings are displayed in the Combination Meter Display (CMD) and/or Multi-Function Display (MFD) with audible beeps. If you take no corrective action, the system automatically reduces engine power and applies the brakes with increasing force to help prevent or minimize the collision.

This system can be turned on or off by using the Pre-Collision Braking System OFF switch (see page 91).

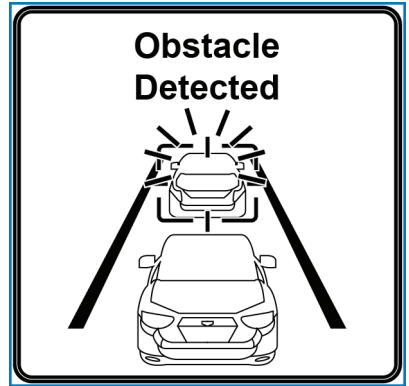

Pre-Collision Brake Assist

This function recognizes a possible collision with another vehicle, a pedestrian, or object in front while you are applying the brakes. If the system determines not enough force is applied, it can assist by applying additional pressure to the braking system to decrease stopping distance.

This system can be turned on or off by using the Pre-Collision Braking System OFF switch (see page 91).

EYESIGHT

Pre-Collision Throttle Management

This function is designed to help prevent you from unintentionally accelerating into a stopped vehicle or other obstacle by reducing engine power. Warnings are displayed in the Combination Meter Display (CMD) with audible beeps.

Pre-Collision Throttle Management is helpful when:

- You unintentionally place the select lever in the “D” position instead of the “R” position and start to accelerate toward a parked car, wall or parking structure.
- The vehicle ahead of you accelerates, but then suddenly slows down or stops.

This system can be turned on or off by using the Pre-Collision Braking System OFF switch (see page 91).

Lane Departure Warning

This function provides audible and visual warnings if you are about to depart your lane of travel. Using the EyeSight® camera, the Lane Departure Warning function identifies lane markings when traveling at speeds of approximately 30 mph or greater. These warnings are displayed in the Combination Meter Display (CMD) with audible beeps. Lane Departure Warning does not provide any corrective actions.

You can turn this system on or off by using the Lane Departure Warning OFF switch (see page 91).

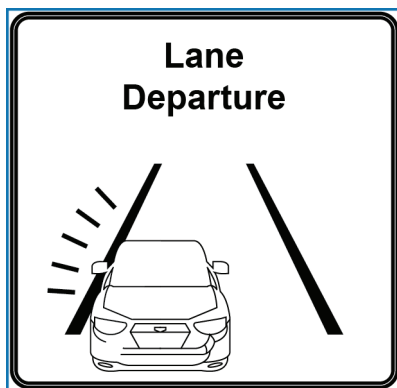

Lane Sway Warning

This function detects repetitive or unusual side-to-side vehicle movement within a lane of travel that may indicate a drowsy or inattentive driver. Using the EyeSight® camera, the Lane Sway Warning function identifies lane markings when traveling at speeds of approximately 37 mph or greater. Warnings are displayed in the Combination Meter Display (CMD) with audible beeps. Lane Sway Warning does not provide any corrective actions.

You can turn this system on or off by using the Lane Departure Warning OFF switch (see page 91).

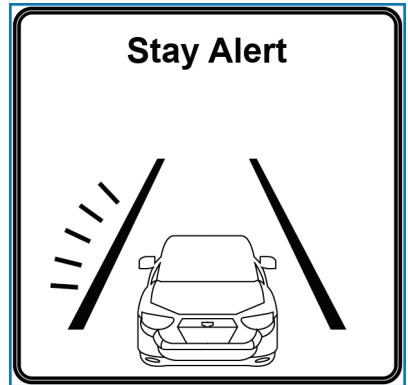

Lane Keep Assist (LKA)

This function provides steering assistance to keep you in the lane of travel when cruising on expressways, freeways, and interstate highways at approximately 37 mph or greater. Lane Keep Assist uses the EyeSight® camera to identify lane markings and assists steering operation to help prevent lane departure.

This function is turned on or off using the Lane Keep Assist button on the right side of the steering wheel. Once the system is turned on, a white Lane Keep Assist icon will be displayed on the Combination Meter Display (CMD). Lane marking graphics on the CMD change to white to indicate that the right and/or left lane markings have been successfully identified by the EyeSight® camera. If the vehicle is about to depart the driving lane, the system assists steering by gently guiding the vehicle back into your lane. When the system is actively providing assistance, the Lane Keep Assist icon in the CMD will change from white to green.

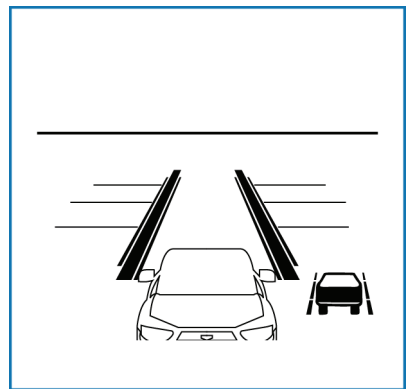

EYESIGHT

Adaptive Cruise Control (ACC)

This system provides Cruise Control with the ability to keep a safe distance from the car in front of you. Using the EyeSight® camera, the Adaptive Cruise Control function identifies vehicles in front when traveling at speeds of approximately 20 mph or greater and manages the acceleration/deceleration of your Subaru to maintain a set speed and distance.

Adaptive Cruise Control is turned on or off using the Adaptive Cruise Control button on the right side of the steering wheel (please refer to page 90). Once the system is turned on, a white Adaptive Cruise Control icon will be displayed on the Combination Meter Display (CMD).

To set Adaptive Cruise Control, push the “SET/-” switch on the right side of the steering wheel. The CMD will indicate a target speed. This speed can be adjusted up or down using the “RES/SET” switch (please refer to page 90).

When a vehicle in front of you is identified, a Lead Vehicle icon will be displayed on the Combination Meter Display (CMD) and/or Multi-Function Display (MFD). You can change the desired following distance from the lead vehicle by pressing the “Increase Distance” or “Decrease Distance” buttons (please refer to page 90).

Conventional Cruise Control

Conventional Cruise Control maintains a constant traveling speed you set, but it does not adapt to the other vehicles in front of you. To switch to Conventional Cruise Control, press and hold the “Increase Distance” or “Decrease Distance” buttons on the steering wheel for approximately two seconds. The Cruise Control indicator on the Combination Meter Display (CMD) will change from the Adaptive Cruise Control icon to the Conventional Cruise Control icon.

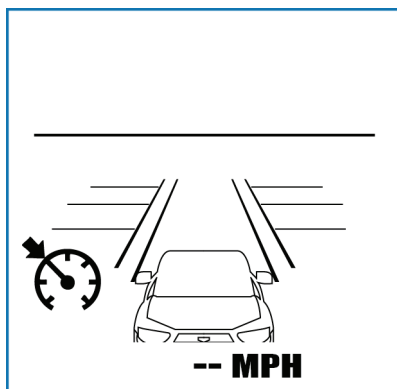
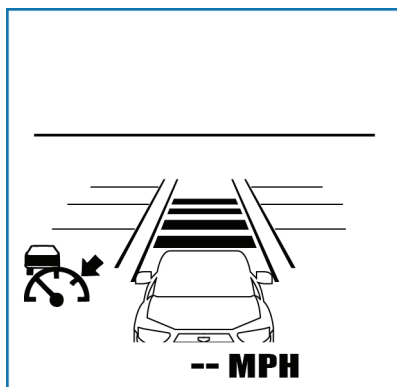

Lead Vehicle Start Alert

This function will provide a visual and audible alert when a stopped vehicle in front of you begins to move, and your vehicle remains stationary. Warnings are displayed in the Combination Meter Display (CMD) with audible beeps. Lead Vehicle Start Alert is helpful in situations where you may become temporarily distracted at a traffic light, and the vehicle ahead begins to move.

This function can be customized. To change this setting, use the steering wheel mounted “i/SET” switches to access the EyeSight® settings menu on the CMD.

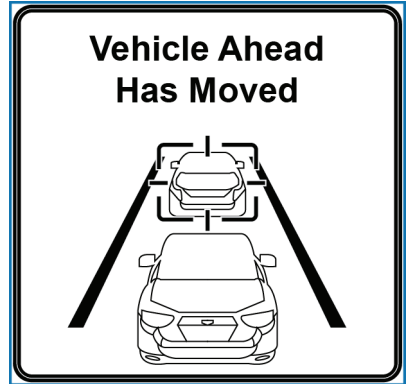

STEERING WHEEL CONTROLS

Adaptive Cruise Control

- 1 Adaptive Cruise Control On/Off:** Press to turn Adaptive Cruise Control (ACC) on or off.
- 2 Lane Keep Assist:** Press to turn Lane Keep Assist on or off.
- 3 Increase Distance:** Press to increase the following distance setting while using Adaptive Cruise Control. Press and hold to change to Conventional Cruise Control.
- 4 Decrease Distance:** Press to decrease the following distance setting while using Adaptive Cruise Control. Press and hold to change to Conventional Cruise Control.
- 5 Resume (RES)/Increase Speed and Set (SET)/Decrease Speed:** Press the switch down to set an initial target speed. Once set, press up or down to adjust the target speed.



Adaptive Cruise Control Switches

- Adjust by 5 mph:
 - Briefly press the switch up to increase the target speed by 5 mph.
 - Briefly press the switch down to decrease the target speed by 5 mph.
- Adjust by 1 mph:
 - Press and hold the switch up to increase the target speed in 1 mph increments.
 - Press and hold the switch down to decrease the target speed in 1 mph increments.
- The Cruise Control Acceleration Characteristics can be adjusted to four different levels depending on your preference. The four levels are:
 - Lv. 1 Eco
 - Lv. 2 Comfort
 - Lv. 3 Standard
 - Lv. 4 Dynamic
- To change this setting, use the steering wheel mounted “i/SET” switches to access the EyeSight® settings menu on the Combination Meter Display (CMD).

Customizing EyeSight® Settings

The EyeSight® system features customization of certain preferences and warnings. Use the steering wheel mounted “i/Set” and arrow switches to navigate through the Combination Meter Display (CMD) to adjust settings such as:

- Warning Volume: Min/Mid/Max
- Cruise Control Acceleration Characteristics: Eco/Comfort/Standard/Dynamic

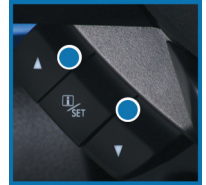

i/Set and Arrow Switches

LANE DEPARTURE WARNING AND PRE-COLLISION BRAKING SYSTEM OFF SWITCHES

Lane Departure Warning OFF Switch

Press and hold this switch on the overhead console for two seconds to turn off the Lane Departure Warning and Lane Sway Warning functions. Press and hold the switch again for two seconds to turn the functions on.

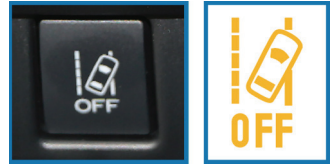

When these functions are off, a yellow Lane Departure Warning OFF indicator will be illuminated in the Combination Meter. It may be helpful to turn these functions off when lane markings on the road are inconsistent.

Pre-Collision Braking OFF Switch

Press and hold this switch on the overhead console for two seconds to turn off the Pre-Collision Braking, Pre-Collision Brake Assist, and Pre-Collision Throttle Management functions. Press and hold the switch again for two seconds to turn the functions on.



When these functions are off, a yellow Pre-Collision Braking OFF indicator illuminates in the Combination Meter Display. It may be helpful to turn these functions off when using a drive-through carwash.

DRIVER ASSIST TECHNOLOGIES

REAR-VISION CAMERA

This function provides a clear view of the area behind the vehicle to help avoid obstacles. Using a wide-angle camera mounted on the rear of the vehicle, an image is automatically displayed on the multimedia screen when you place the select lever in the “R” position. The displayed image features a centerline indicator, colored distance markers, and dynamic guidelines that move as the steering wheel is turned.



BLIND-SPOT DETECTION (BSD)/ REAR CROSS-TRAFFIC ALERT (RCTA) (if equipped)

This system uses radar sensors mounted behind the rear bumper on the left and right sides that warn you if another vehicle is sensed in your blind spots. These functions provide additional awareness when changing lanes or driving in reverse.

Blind-Spot Detection (BSD)

This function senses if a vehicle is in your blind spot and provides a visual warning (yellow light) in the corresponding side mirror frame. The default operation of BSD is on.



Lane Change Assist (LCA)

Lane Change Assist (LCA) works with Blind Spot Detection to provide an additional level of warning if you attempt to change lanes with a vehicle in your blind spot. LCA will rapidly flash the corresponding side mirror indicator if you operate your turn signal while a vehicle is in your blindspot. The default operation of LCA is on.

DRIVER ASSIST TECHNOLOGIES

Rear Cross-Traffic Alert (RCTA)

This function detects a vehicle approaching from either side as you reverse and provides audible and visual warnings. Warnings will appear in the upper corners of the Rear-Vision Camera display and side mirrors, and audible beeping will sound. The default operation of RCTA is on.



BSD/RCTA can be turned on or off by pressing the BSD/RCTA OFF switch in the instrument panel. When this function is off, a yellow BSD/RCTA OFF indicator will be displayed in Combination Meter Display (CMD).

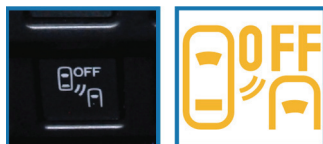

HIGH BEAM ASSIST (HBA) (if equipped)

This function uses the EyeSight® cameras to automatically switch the headlights between high and low beam settings when an oncoming vehicle is detected, enhancing safety for both you and other drivers on the road.



To activate High Beam Assist, set the headlight control switch to the "AUTO" position and push the headlight lever forward to the high beam position. The green HBA indicator will illuminate on the Combination Meter Display (CMD). When vehicle speed is above approximately 20 mph, HBA will automatically switch between high and low beams. When the high beams are activated, the blue high beam indicator will be displayed in the Combination Meter.

STEERING RESPONSIVE HEADLIGHTS (SRH) (if equipped)

The Steering Responsive Headlights (SRH) system aims the headlight beams in the direction you are steering, improving visibility at corners and intersections when driving at night. Although the system is normally on, you can turn the system off using the SRH OFF switch located on the lower left console.

DRIVER ASSIST TECHNOLOGIES

REVERSE AUTOMATIC BRAKING (RAB) (if equipped)

This system uses four rear bumper mounted sonar sensors to detect objects when moving between 1 and 9 mph in reverse. RAB uses the Rear-Vision Camera image to display colored proximity alerts when an object is detected. As an object becomes closer to the rear of your vehicle, audible beeps provide additional awareness in three progressive levels. If RAB determines that a collision with an object is possible, the system can automatically apply the brakes to help prevent or minimize the impact.

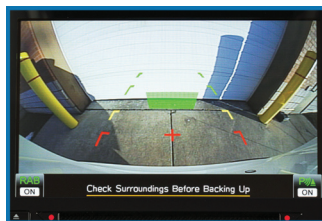

The default operation of the RAB system is on, but in some cases, such as connecting a trailer, it may be helpful to temporarily turn the system off. RAB can be turned off using the Touchscreen buttons on the lower corners when the select lever is in the "R" position.

All functions will automatically return to ON the next time the select lever is shifted to the "R" position.

Touch and hold the "RAB ON" button in the lower left of the Touchscreen until it changes to "RAB OFF" to disable the automatic braking functions of the RAB system.



Touch and hold the "P))) ON" button in the lower left of the Touchscreen until it changes to "P))) OFF" to disable the audible beeping of the RAB system.



CARE AND LIMITATIONS

STEREO CAMERA PRECAUTIONS

Your EyeSight® stereo cameras are precision components that must be kept free from obstruction and contamination, such as fingerprints or cleaning solutions. When the system detects that the stereo camera lenses are impaired, a malfunction indicator will be displayed and EyeSight® functions will not be available.

When you are in the vicinity of the EyeSight® stereo cameras, always observe the following precautions:

- Do not touch or attempt to clean the EyeSight® camera lenses inside the vehicle. Extra caution should be used when cleaning the inside of the windshield. Over-spray from cleaning solutions may impair or even damage the camera lenses. Please inform others who may attempt to clean the windshield, such as car wash staff, of this precaution.
- Electronic Toll Collection devices, such as EZPass™, must be installed in an area that does not obstruct the stereo cameras' field of vision. See "Prohibited Area" on page 96.
- Adjust the rearview mirror so it does not obstruct the stereo cameras' field of vision.
- Do not install any interior rearview mirror accessories, such as a wide-type mirror or hanging objects. Only approved Genuine SUBARU accessories may be installed.

For more detailed information, please refer to your EyeSight® Owner's Manual.

WINDSHIELD GLASS AND DASHBOARD

Since the characteristics of the EyeSight® stereo cameras are similar to human limitations, it is important that the area in front of the cameras be kept free from dirt, scratches, cracks, fogging, or accessories mounted to the windshield, hood or dashboard. Visual impairments or reflections can affect EyeSight® system performance. Extra caution should be taken when cleaning the windshield to prevent over-spray from cleaning solutions.

The images in the section below outline those areas that must be kept clean and free from obstruction. Please refer to the Owner's Manual for a complete listing of limitations.

FRONT VIEW

Impreza (Front View)

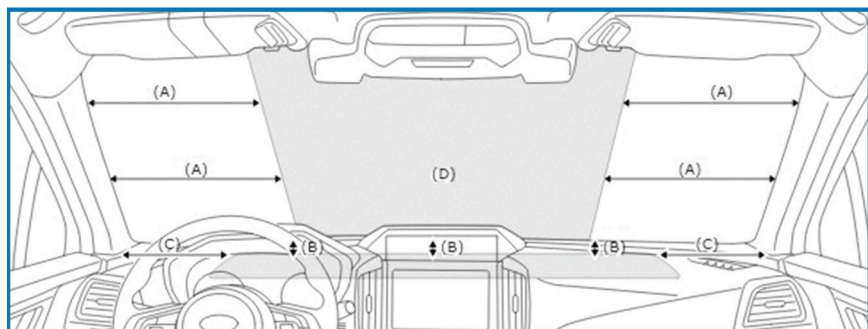

(A) 13.2 in (355 mm)
(B) 5.5 in (139 mm)

(C) 9.6 in (243 mm)
(D) Prohibited area (in gray)

EYESIGHT DISCLAIMER

EyeSight® is a driver assist technology which may not operate optimally under all driving conditions. The driver is always responsible for safe and attentive driving. System effectiveness depends on many factors such as vehicle maintenance, weather and road conditions. See Owner's Manual for complete details on system operations and limitations.

The Pre-Collision Braking system is designed to provide automatic braking that either prevents a collision or reduces the severity of a frontal impact.

The Pre-Collision Throttle Management system is designed to reduce acceleration and minimize the severity of certain frontal impacts.

Adaptive Cruise Control and Brake Light Recognition are designed to assist the driver and are not substitutes for safe and attentive driving.

Lane Keep Assist operates only when the lane markings are visible, and system effectiveness depends on many factors.

Blind-Spot Detection, Lane Change Assist and Rear Cross Traffic Alert are systems designed to assist the driver by monitoring the rear and side areas of the vehicle during a lane change or reversing and not a substitute for safe and attentive driving.

The Reverse Automatic Braking System is not a substitute for safe and attentive driving. System effectiveness depends on many factors, such as vehicle maintenance, weather and road conditions. Always exercise caution and use vehicle mirrors and the Rear-Vision Camera when backing up. See Owner's Manual for complete details on system operation and limitations.

HOW TO APPENDIX

HOW TO OVERVIEW

This “how to” appendix provides detailed, step-by-step instructions to easily connect with features of your Impreza.

If you need some help with these features or want to learn more, we are here to assist you:

Your Subaru Owner's Manuals:

Located in the glovebox

Online Subaru Owner's Resources:

www.subaru.com/owners

Subaru Customer Support:

www.subaru.com/customer-support

1-800-782-2783 (1-800-SUBARU3)

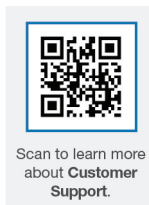
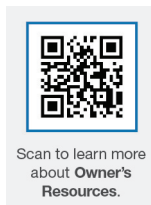

BLUETOOTH® PAIRING

Pairing an Android Device

1. To pair an Android device, start by touching the “Settings” icon on the “Home” screen and then the “Phone” icon to go to the phone screen.

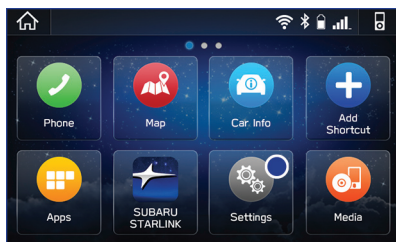

2. Select “Add Device”/”Add Phone”.

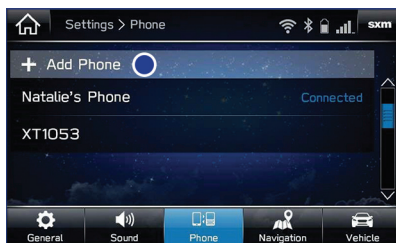

HOW TO APPENDIX

- This screen will be displayed when pairing mode is in progress. The device name will most likely be Subaru BT, but be sure to make note of what name it is, so you can find it on your phone.

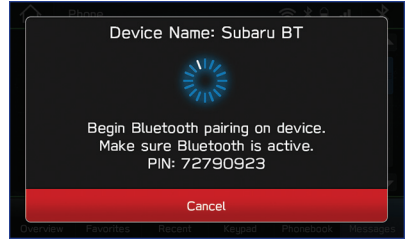

- On your Android device, go to "Settings". (It can be found under apps.) Then select "Connected Devices" or "Connections".

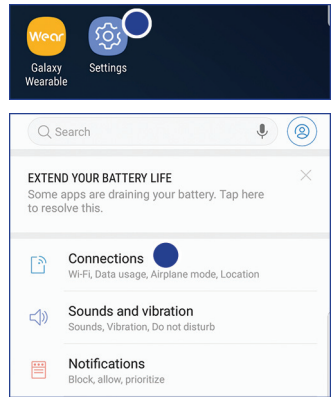

- Now select "Bluetooth". This will show a screen to "Pair New Device" or it will be showing the nearby devices to add. Select "Subaru BT" if shown on the list or "Pair New Device".

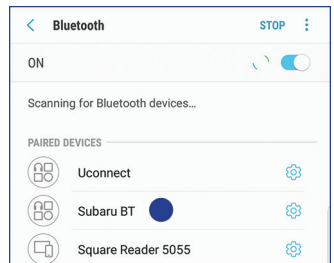
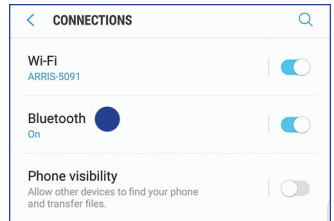

HOW TO APPENDIX

6. Now select “Pair”. Make sure to select “Yes” to the “Message Access Request” pop-up box to allow access to your contacts and call history.

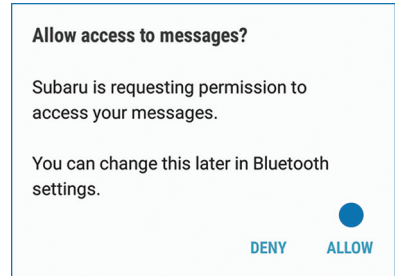
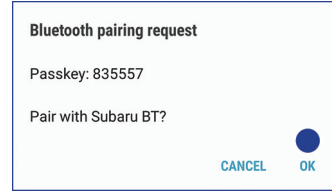

7. Next, on the Touchscreen, select “Confirm” if the PIN matches the phone. Then select “Download” to download the phonebook contacts.

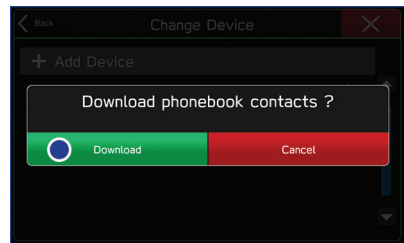
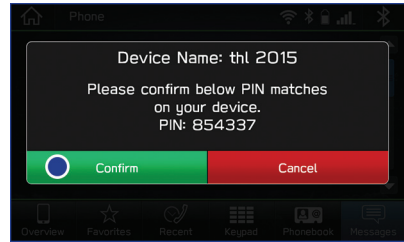

HOW TO APPENDIX

8. If your phonebook or messages are not appearing correctly on the vehicle display, go to "Phone" from the Home screen and select "Change Device". Make sure that "Phonebook Download" is enabled under "Overview".

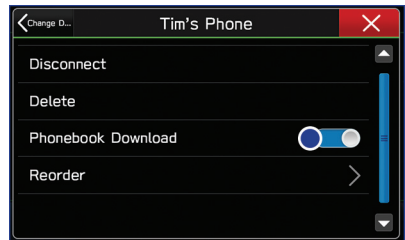
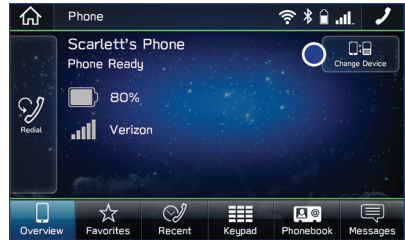

9. If you still cannot access your phonebook or messages, go back to your phone's Bluetooth® settings and select the gear icon next to your vehicle's device name and ensure all settings are enabled.

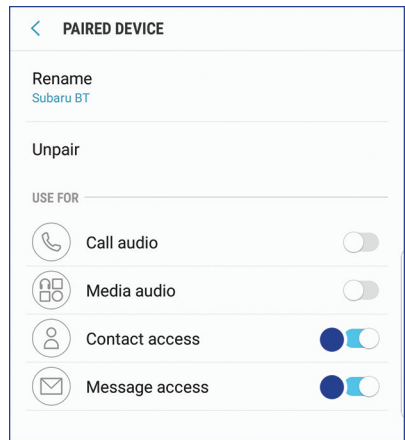

HOW TO APPENDIX

Pairing an iOS/Apple Device

1. Start by touching “Settings” on the Home screen.

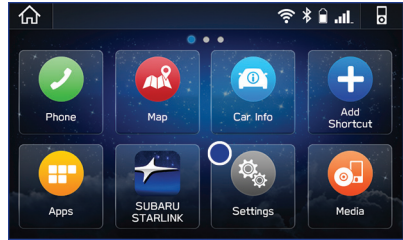

2. Go to the “Phone” screen and select “Add Device” / “Add Phone”.

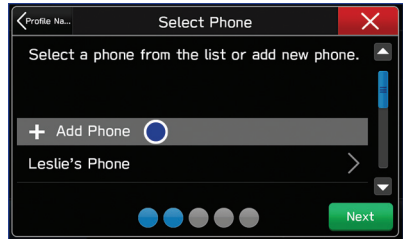

3. When this screen is displayed, it is in pairing mode. Take note of the “Device Name”; it will most likely be “Subaru BT”.

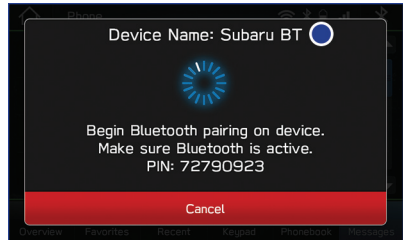

4. On your iOS/Apple device, touch “Settings”. The location on the Home screen will vary.



HOW TO APPENDIX

5. Select “Bluetooth”.

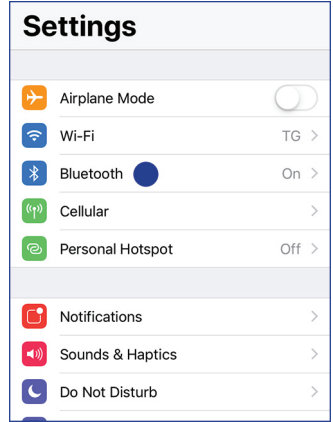

6. Now select the device name (usually “Subaru BT”) on the Touchscreen.

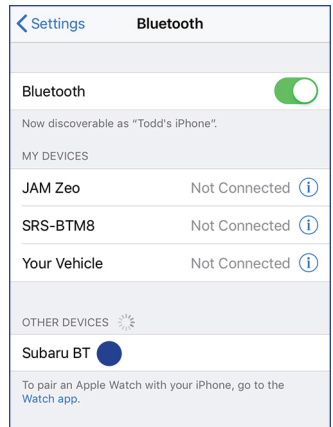

HOW TO APPENDIX

7. Verify your iOS/Apple device PIN is correct and select "Pair". Then select "Allow" on the "Allow Contacts and Favorites Sync?" screen.

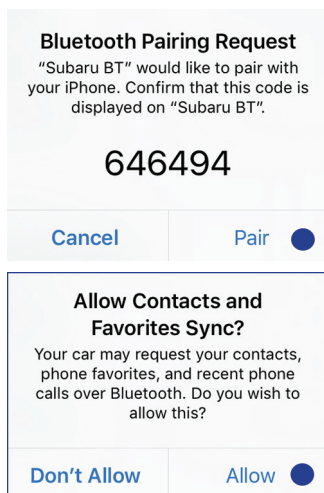

8. Verify the PIN on the vehicle screen and select "Confirm", then select "Download".

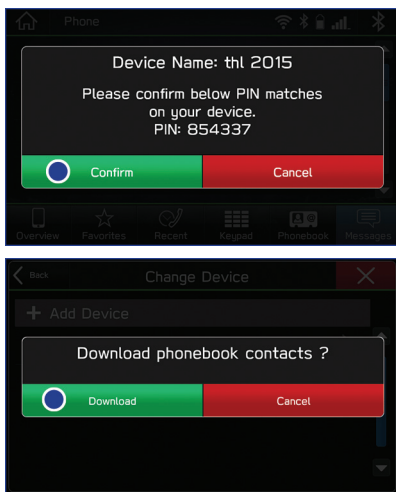

HOW TO APPENDIX

9. On your iOS/Apple device, SubaruBT should now be listed under “Bluetooth Settings”. Select the blue “i” next to the device name. Then ensure “Show Notifications” and “Sync Contacts” are enabled.

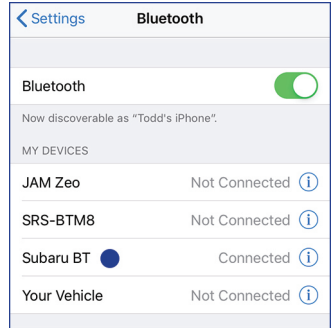

10. Your iOS/Apple device is now paired. It is recommended that you restart your Subaru to complete the process and ensure everything is fully synced.

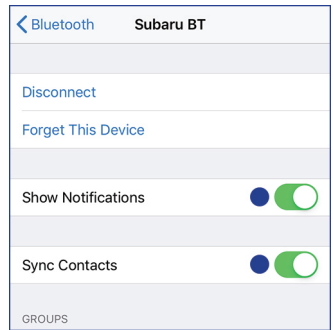

11. If your phonebook or messages are not appearing, press the “Phone” icon on the vehicle screen. Next, select “Change Device” under “Overview” and ensure the “Phonebook Download” is enabled.

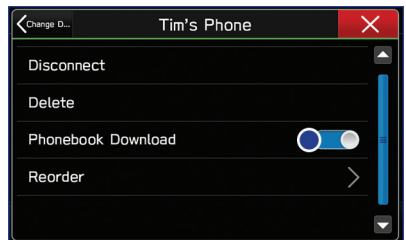

HOW TO APPENDIX

ANDROID AUTO™

Cables

Always use a high-quality OEM USB cable.

Ensure the Android phone is fully up to date. Also verify that the Android Auto app, along with all other apps that work with Android Auto, are up to date. Android Auto might not function properly if one of them is outdated or having an issue. The apps can be downloaded from the Play Store.

 For more information, visit: www.android.com/auto/



Scan to learn more about
Android Auto

Connecting an Android Phone

1. To set up Android Auto, first plug the Android phone into the USB port of the vehicle using a quality OEM cable. The first time you plug in, this message will appear. Select “Accept”. After that, select “Accept” to any other prompts that appear. Android Auto might also need to download before functioning on the vehicle; allow it to do so.

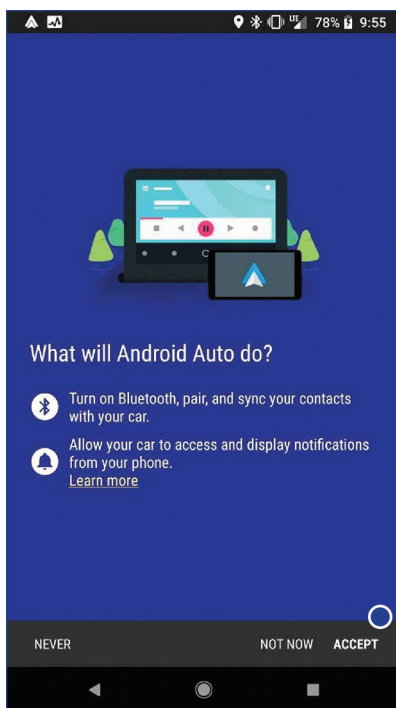

HOW TO APPENDIX

2. On the vehicle display screen, Android Auto should auto launch the first time. If not, select the Android Auto Icon on the display. Select “Show Me How” for a quick guide on using Android Auto, or select “Skip” if you want to start using the app right away.

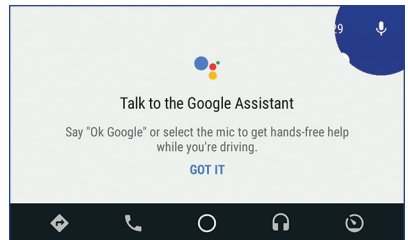
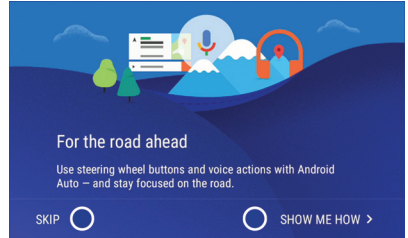

3. You will then be taken to the Home screen of the Android Auto app for your phone.

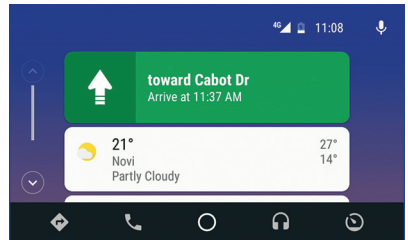

4. If Android Auto won't launch, open the Android Auto app on the phone, then select the top left menu button. Select “Settings”, then “Connected Cars”, and finally select the top right menu icon and choose “Forget all cars”.

If this does not work, uninstall the Android Auto app from the phone and reinstall from the Play Store.

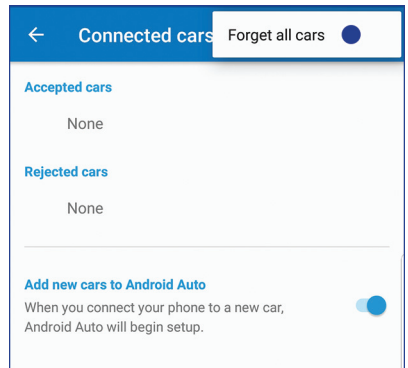

HOW TO APPENDIX

Compatible Models

Android Auto is available on Android phones. To see if your phone is compatible, please refer to the Android Auto website:

<https://www.android.com/phones/>



Scan to see if
your phone is
compatible with
Android Auto

APPLE CARPLAY®

Cables

Apple CarPlay requires compatible iPhones to be connected via your Subaru's USB port. Cables must be an 8-Pin Lightning MFi Certified cable (made for iPod/iPhone). Look for the Works with Apple CarPlay or Made for iPod, iPhone, iPad icons when selecting a cable.

 For more information, visit: www.apple.com/ios/carplay/



Scan to learn
more about
Apple CarPlay

Connecting an iPhone

1. To set up Apple CarPlay, you will need to plug the iOS/Apple phone into the USB port of the vehicle. Make sure to use an MFI certified cable.
2. Select “Allow” on the iOS/Apple phone when prompted.
3. Select Apple CarPlay on the vehicle screen. This will bring you to the home screen of your phone in Apple CarPlay.

Ensure the iOS/Apple phone is fully up to date. Also ensure all apps that work on Apple CarPlay are up to date. Apple CarPlay might not function correctly if one of the apps is outdated or having an issue. Apps can be updated in the App Store.

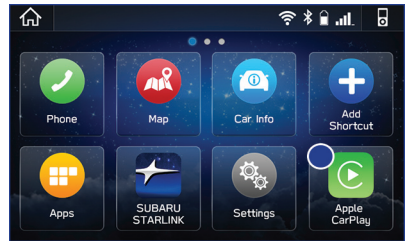
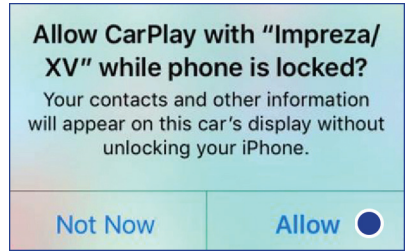

Compatible Models

For a list of all the Apple phones that are compatible with Apple CarPlay, visit: www.apple.com/ios/carplay/



Scan to learn more about Apple CarPlay

HOW TO APPENDIX

WI-FI

Connecting to a Wi-Fi Network

1. Display the General Settings screen by pressing the “Home” button, then select “Settings”.
2. Under the “General” tab, select “Wi-Fi Settings”.
3. Select the desired network. If the network is a secure network, a lock symbol appears on the right side of the screen.
4. Select “Connect” to connect to the network or “Disconnect” to disconnect from the network. Selecting “Forget This Network” deletes the network. If you are connecting to a secure network, enter the password and select “Join”.
5. Check that a confirmation message appears when the connection is complete. If an error message appears, follow the guidance on the screen to try again.

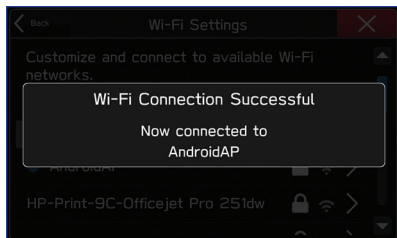
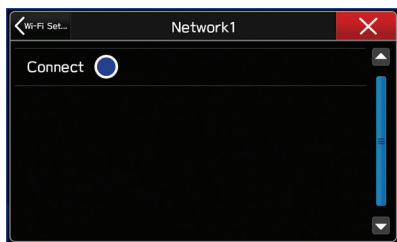
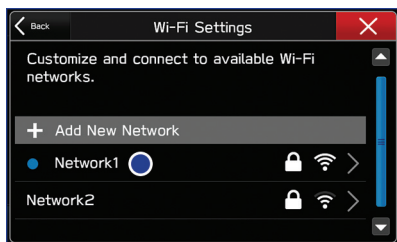
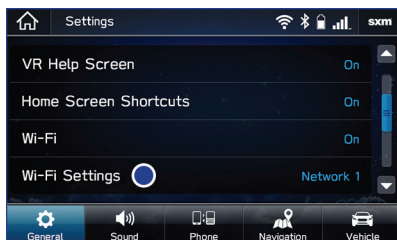

Wi-Fi Hotspot Subscription

Internet access is purchased separately through AT&T with monthly, per gigabyte, and unlimited data options available. Existing AT&T customers have the option to add an additional line to their AT&T Mobile Share plan.

Shortly after you take delivery of your new Subaru, you will receive an email from AT&T for a one month free trial and how to activate your free trial.

 You can also visit an AT&T store or their website for more information at:

<https://www.att.com/plans/connected-car/subaru.html>.



Scan to learn
more about
AT&T plans

FIRMWARE SOFTWARE UPDATES

For 8.0-inch Multimedia Plus and 8.0-inch Multimedia Navigation systems, you can update the system software via a Wi-Fi connection or the aha™ application on your smartphone (depending on your smartphone communication and transfer speed). The update process involves downloading and installing the software update. System functionality will be restricted during installation.

1. Connect to a Wi-Fi network or start the aha application on your smartphone.
2. Display the general setting screen by pressing the “Home” button, then select “Settings” and finally “General”.
3. Select “Check for Updates”. If “Automatically Check for Updates” is turned on at the general settings screen, an update check will be performed automatically before proceeding to the next step. If “Automatically Download Updates” is turned on at the general settings screen, the software update will be downloaded automatically before proceeding to “Update Installation”.
4. If the “Software Update Ready to Download” pop-up is displayed, select “Download Now” to begin the download. The download status progress is displayed in the upper right of the screen.
5. Select “Install Now” to start the installation process. The installation process will take several minutes to complete. If you need to stop the installation process, press “Cancel”.
6. When the installation is complete, select “I Agree” on the confirmation message to complete the update process. By selecting “I Agree”, the system will restart automatically.

HOW TO APPENDIX

MAP UPDATES

At subaru-maps.com, you can update the entire USA map at once via USB. Maps can also be updated over a Wi-Fi network. To update your maps, follow this process:

- 1 Connect to a Wi-Fi Network. If you need help with this, see page 110.
- 2 From the Home screen, select “Settings” then “Navigation”. Next, select “Map Update” on the navigation setting screen.
- 3 Select “Select Region (Max up to 8)” to select the regions you would like to update.

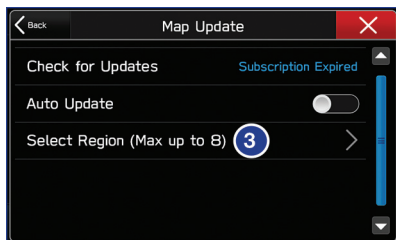

- 4 Select the regions for which maps are to be updated.



- 5 Select “Back”.



HOW TO APPENDIX

- 6 Select “Check for Updates”.

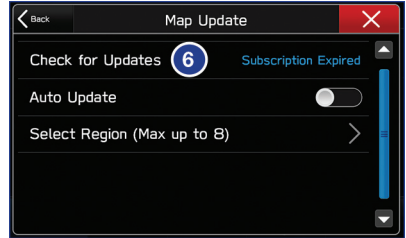

- 7 Check the confirmation message, then select “Yes”.

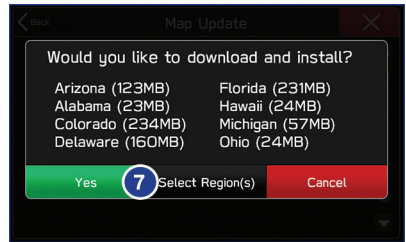

- 8 The following screen is displayed simultaneously with the start of the download and installation. To stop the download and installation, select the “X” in the upper right corner.

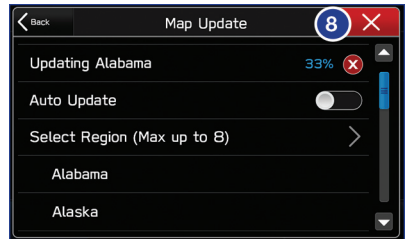

INDEX

2.0L ENGINE 44

A

ACCESSORY CONNECTIONS 24

ADAPTIVE CRUISE CONTROL 26

ADDING SHORTCUTS 55

ANDROID AUTO™

Cables 106

Compatible Models 108

Connecting an Android Phone 106

APPLE CARPLAY®

Cables 108

Compatible Models 109

Connecting an iPhone 109

AUDIO CONTROLS 25

B

BLIND-SPOT DETECTION (BSD)/ REAR

CROSS-TRAFFIC ALERT (RCTA)

Blind-Spot Detection (BSD) 92

Lane Change Assist (LCA) 92

Rear Cross-Traffic Alert (RCTA) 93

BLUETOOTH® PAIRING

Pairing an Android Device 98

Pairing an iOS/Apple Device 102

BUTTONS

CD Player Functions (if equipped) . . . 48

Controlling the Volume 49

Other Functions 49

Radio Functions 48

C

CARGO COVER 41

CHILD SAFETY LOCKS 38

CLIMATE CONTROL

Automatic Climate Control 20

Heated Seats 23

Manual Climate Control 20

Remote Engine Start with Climate
Control 23

CLOCK

Automatically 81

Manually 82

CREATING A DRIVER PROFILE

Retrieving a Driver Profile 56

CREATING HOME AND WORK

PROFILES 69

CRUISE CONTROL 26

D

DRIVING THE VEHICLE

5-Speed Manual Transmission 34

Automatic Transmission Shift Mode . 34

Paddle Shift Control Switches (if
equipped) 35

SI-DRIVE (if equipped) 35

E

ENGINE OIL 45

ENGINE OIL CAPACITY 45

ENROLLMENT 76

EYESIGHT® OVERVIEW 84

F

FINDING A DESTINATION

Arrival Time/Distance 69

Canceling Guidance 74

Finding a Destination by Address . . . 69

Finding a Destination by POI 70

Guidance Screen Icons 72

Map View/Perspectives 73

Map Zoom 72

Nearest Gas Station 74

Route Options 71

Saving Destination as a Favorite . . . 71

Shortest/Fastest/Economic 71

Traffic Information 73

FIRMWARE SOFTWARE UPDATES . . 111

FOLDING THE REAR SEATS 38

FUEL 37

FUEL CAPACITY 37
 FUEL FILLER LID 37

FUNCTIONS
 Adaptive Cruise Control (ACC) 85
 Conventional Cruise Control 88
 Lane Departure Warning 86
 Lane Keep Assist (LKA) 87
 Lane Sway Warning 87
 Lead Vehicle Start Alert 89
 Pre-Collision Brake Assist 85
 Pre-Collision Braking 85
 Pre-Collision Throttle Management . . . 86

G

GAUGES 31
GENERAL
 Connect to Home Wi-Fi 78
 Performing Software Updates 79

H

HIGH BEAM ASSIST (HBA) 93
 HOME SCREEN ICONS 54
 HOOD PROP 43
 HOW TO OVERVIEW 98

I

IGNITION SWITCH 33
 IMPORTANT SAFETY INFORMATION . . . 4
 Impreza (Front View) 96
IN CASE OF EMERGENCY
 Subaru Roadside Assistance 5
 SUBARU STARLINK® Safety and
 Security 5
 INFO SWITCH 27
 INSTRUMENT PANEL SWITCHES (LOWER
 LEFT) 25
 INTERNAL SAFETY TRUNK RELEASE
 WITH SELF-ILLUMINATING HANDLE
 40
 I/SET SWITCH 27

K

**KEYLESS ACCESS WITH PUSH BUTTON
 START**
 Locking Using Door Handles 9
 Locking Using the Rear Gate (5-door
 models) 11
 Unlocking the Trunk (Sedan Models) . 10
 Unlocking Using Door Handles 9
 Unlocking Using the Rear Gate (5-door
 Models) 10
KEYLESS ENTRY
 Automatic Door Locking/Unlocking . . 7

L

**LANE DEPARTURE WARNING AND
 PRE-COLLISION BRAKING SYSTEM
 OFF SWITCHES**
 Lane Departure Warning OFF Switch . 91
 Pre-Collision Braking OFF Switch . . 91
LATCH/ANCHOR 39
LIGHT CONTROLS
 Daytime Running Lights 28
 Illumination Brightness 28

M

MAKING A CALL 61
MAPS/NAVIGATION
 Checking for Updates 80
 Updating Over-the-Air 81
 Updating using your PC/MAC 81
MAP UPDATES 112
MEDIA
 Aux Input 60
 Bluetooth® 60
 CD (if equipped) 60
 USB / iPod 60
MYSUBARU
 Service Appointment Scheduler . . . 68
MYSUBARU INTEGRATION 76

INDEX

N

NEW VEHICLE BREAK-IN 45

O

OPERATION 84

OVERHEAD CONSOLE 30

OVERVIEW OF YOUR MULTIMEDIA
SYSTEM

 Various Systems 48

OWNER'S RESOURCES 4

P

PAIRING A PHONE 61

PHONE 80

POWER EXTERIOR MIRRORS 16

POWER MOONROOF

 Sliding the Moonroof 19

 Tilting the Moonroof 19

POWER WINDOWS 18

PUSH-BUTTON IGNITION SWITCH . . 33

R

RADIO

 AM/FM Radio 58

 Presets 59

 Satellite Radio 59

REARRANGING ICONS 54

REAR SEAT REMINDER 40

REAR VIEW MIRROR

 Auto-dimming Mirror 17

 HomeLink® 5 Accessory Mirror . . 17

REAR-VISION CAMERA 92

REAR WINDOW WIPER 29

RECEIVING A CALL 62

REVERSE AUTOMATIC BRAKING

 (RAB) 94

ROOF RAIL CAPACITY 46

S

SAFETY AND SECURITY OVERVIEW . . 75

SEATING

 Head Restraint Adjustment 14

 Manual Seats 14

 Power Driver's Seat 14

 Seatbelt Adjuster 15

SOUND 79

SPARE TIRE AND JACK 42

STARTING THE VEHICLE

 Without Push-button Ignition 33

 With Push-button Ignition 33

STEERING RESPONSIVE HEADLIGHTS

 (SRH) 93

STEERING WHEEL CONTROLS 51

 Adaptive Cruise Control 90

 Customizing EyeSight® Settings . . 91

STEREO CAMERA PRECAUTIONS . . . 95

SUBARU STARLINK® IN-VEHICLE APPS

 aha™ by HARMAN 64

 Android Auto™ 65

 Apple CarPlay® 65

 Pandora® 64

 SiriusXM® Travel Link 65

SUBARU STARLINK® MOBILE APP

 Chimani 66

 eBird 67

 Getting Started Guide Information . . 66

 Yelp 66

SUBARU STARLINK® WI-FI HOTSPOT . 77

T

TEXT MESSAGES 63

TILT AND TELESCOPIC STEERING

 COLUMN 16

TIRE PRESSURE MONITORING SYSTEM

 (TPMS) 47

TOUCHSCREEN 50

TOWING YOUR ALL-WHEEL DRIVE

 SUBARU 6

TRAILER TOWING CAPACITY 46

TRUNK LID OPENER (Sedan Models)	41
TURNING OFF THE VEHICLE	
Without Push-button Ignition	36
With Push-button Ignition	36
TURN SIGNALS	29

V

VOICE RECOGNITION	
Common Commands	52
Tips	52

W

WARNING AND INDICATOR LIGHTS	32
WELCOME	4
WI-FI	
Connecting to a Wi-Fi Network	110
Wi-Fi Hotspot Subscription	111
WINDSHIELD GLASS AND	
DASHBOARD	95
WINDSHIELD WIPERS	29

NOTES

Subaru of America, Inc.
One Subaru Drive
Camden, NJ 08103-9800



MSA5B2101A
Issued July 2020
Printed in USA 07/20

