

# BRZ

## 2017

### Quick Reference Guide



Love. It's what makes a Subaru, a Subaru.



Complete U.S. specifications and illustrations may not have been available at time of publication. Specifications are based on the latest product information available at time of publication. Some images shown are for illustration purposes only. Some equipment shown may be optional at extra cost. Specific options may be available only in combination with other options. Specific combinations of equipment or features may vary from time to time and by geographic area. Certain accessories and equipment may not be available at the time of publication.

This Quick Reference Guide applies to all BRZ models. Therefore, some explanations may be for equipment not installed on your vehicle. Subaru of America, Inc., reserves the right to change or discontinue at any time, without notice, prices, colors, materials, equipment, accessories, specifications, models and packages without incurring any obligation to make the same or similar changes on vehicles previously sold. Colors shown may vary due to reproduction process.

For detailed operating and safety information, please consult the Owner's Manual.

Subaru, Outback, Legacy, Forester, Impreza, BRZ, WRX, WRX STI, BOXER, SI-DRIVE, Lineartronic, Alcantara, EyeSight, HD Radio, Aha Radio and SiriusXM are registered trademarks. SUBARU STARLINK is a trademark of Fuji Heavy Industries, Ltd.

All rights reserved. Contents may not be reprinted or electronically reproduced in whole or in part without prior written approval of Subaru of America, Inc.

© 2016 Subaru of America, Inc.

# Table of Contents

---

2-3	<b>Getting Started</b>
4-5	<b>Instrument Panel</b>
6-9	<b>Gauges</b>
10-11	<b>Personalize</b>
12-19	<b>Controls</b>
20-21	<b>While Operating</b>
22-23	<b>Safety/In Case of Emergency</b>
24-26	<b>Additional Information</b>

# Remote Keyless Entry

## 1. Lock/Arm

- Press to lock all doors and trunk and activate the security alarm.
- If any of the doors or the trunk are not fully closed, an electronic chirp will sound to alert you that the doors or the trunk are not properly closed.

## 2. Unlock/Disarm

- Press once to unlock the driver's door.
- Press twice (within five seconds) to unlock all doors.
- When the "Unlock/Disarm" button is pressed, the dome and map lights will illuminate if the dome light switch is in the middle position.

## 3. Opening the Trunk Lid

- Press and hold to unlock the trunk lid. An electronic chirp will sound.

## 4. Panic Alarm

- Press and hold; the horn will sound and the hazard lights will flash.
- Press any button on the remote to deactivate.



## Keyless Access with Push Button Start System (if equipped)

By simply carrying the access key in your pocket, you can lock and unlock doors, open the trunk lid and start your car without ever having to take the key fob out of your pocket.



# Seating

## Heated Seats (if equipped)

Switches are located on the center console between the driver and passenger seats. Choose low (bottom of switch) for normal heating or high (top of switch) for rapid heating. Choose the center position to turn off the seat heaters.



## Seat Controls

### 1. Forward/Backward

Pull up on the lever below the front of the driver's seat to move the seat forward or backward.

### 2. Raise/Lower Seat Cushion

To adjust the height of the driver's seat, push or pull the seat height adjustment lever located on the lower left side front of the seat.

### 3. Recline Seatback

To adjust the seatback to the desired position, pull up on the recline lever located on the lower left rear of the driver's seat or lower right rear of the passenger's seat. Do not adjust seats while driving.

### 4. Seatback Fold Strap

To get in and out of the back seats, pull the seat strap to fold the desired seat. When finished, push the seatback until it locks in place.

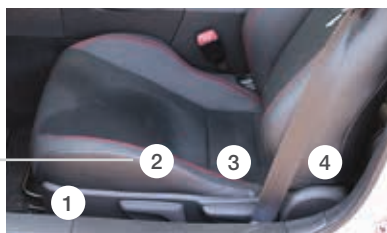

## Folding Down the Rear Seats

Lower the headrests. Open the trunk and pull the release strap on the seat side that you want to fold down. To return the seatback to its original position, raise the seatback until it locks into place and make sure that it is securely locked.



# Instrument Panel

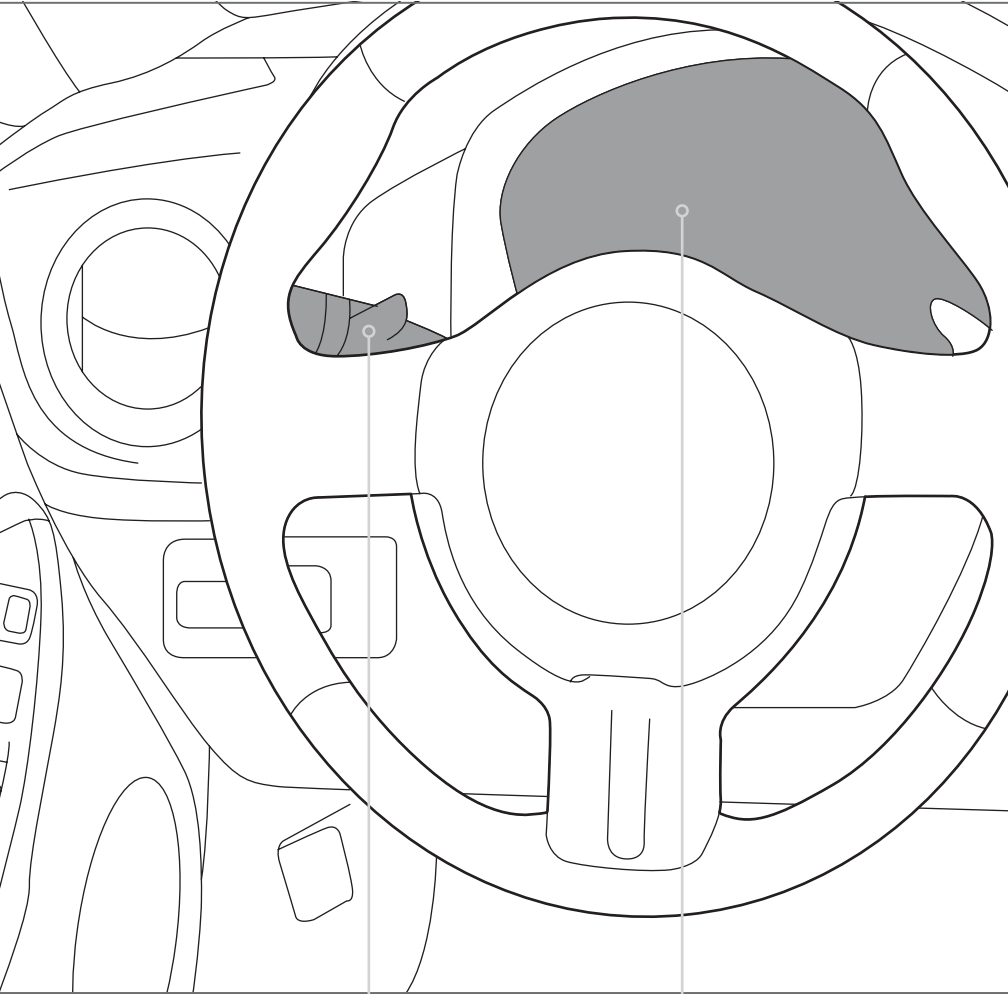

PAGE  
NUMBER

12

6-9

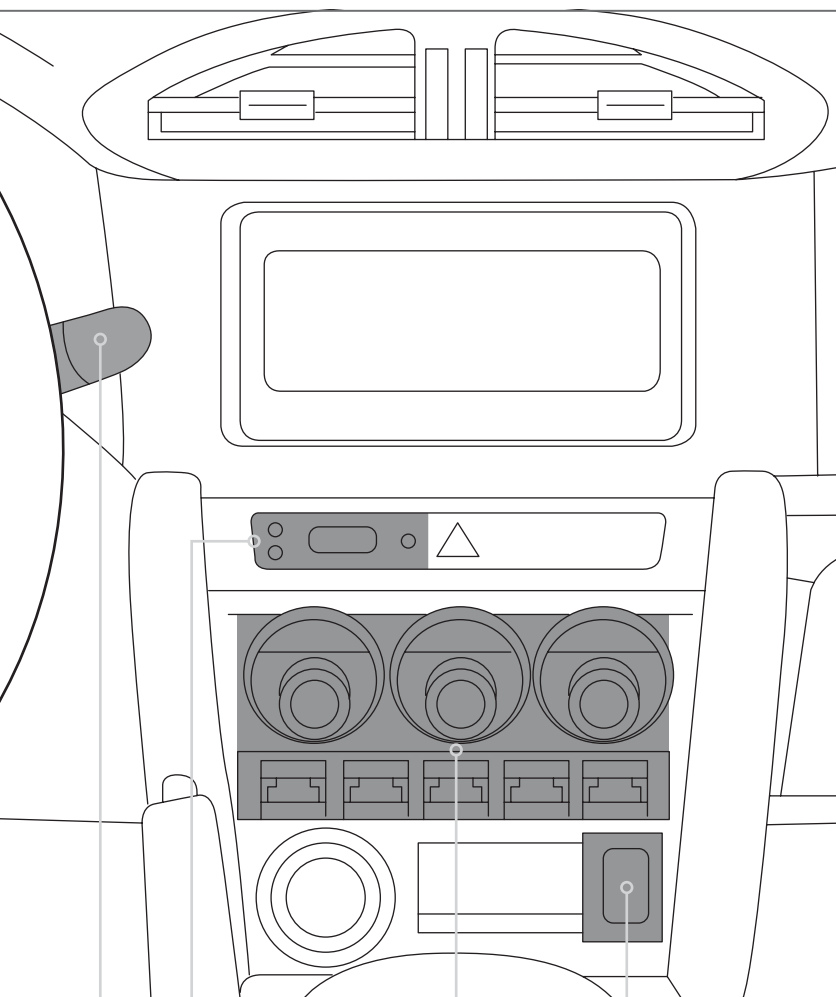

13

14-15

18

### Clock

Press the "H" button to adjust the hours and the "M" button to adjust the minutes. Vehicles with a navigation system, please refer to the separate booklet "Operating Instructions for Navigation System."

# Gauges

BRZ Premium

- Immediate Attention
- Caution
- Informational

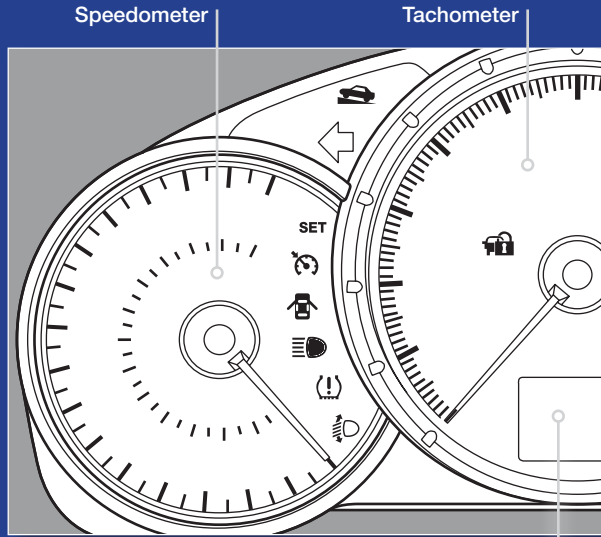

Outside temperature, trip meter and odometer



Seatbelt warning

**BRAKE** /

Brake system



Front passenger seatbelt warning



Hot coolant temperature/  
Cold coolant temperature



SRS airbag system



High beam indicator light



Engine immobilizer indicator light

**A/T OIL TEMP**

AT OIL TEMP  
(Automatic Transmission)



Door open

**ABS** /

ABS warning



Charge warning



Low fuel



Oil pressure warning

**SNOW**

SNOW indicator  
(Automatic Transmission)



Power steering warning



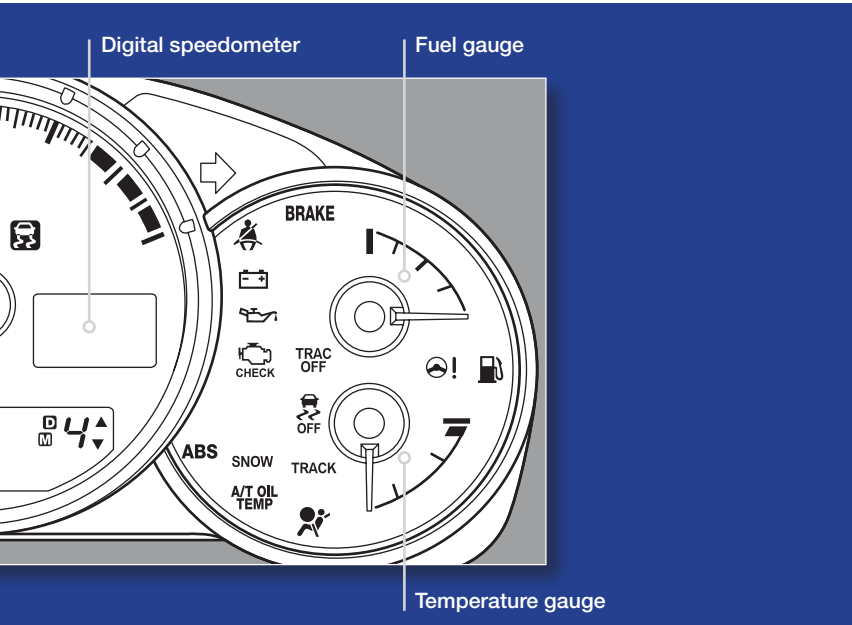

Slip indicator

**TRACK**

TRACK indicator



VSC off



Turn signals



CHECK engine/  
Malfunction indicator



Front fog light indicator  
light (if equipped)



Tire pressure warning light



Cruise control  
indicator light



Front passenger frontal  
airbag OFF/ON

**SET**

Cruise control set  
indicator light



Headlight leveler  
(if equipped)



TRAC OFF indicator



Incline start assist

# Gauges

BRZ Limited

- Immediate Attention
- Caution
- ■ Informational

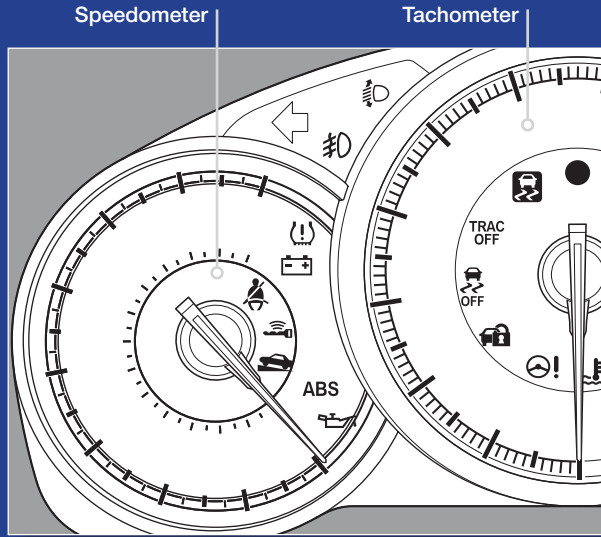

Seatbelt warning



REV indicator



Front passenger seatbelt warning



Brake system



SRS airbag system



Hot coolant temperature/  
Cold coolant temperature



Engine immobilizer indicator light



High beam indicator light



Door open



AT OIL TEMP  
(Automatic Transmission)



Charge warning



ABS warning



Oil pressure warning



Low fuel



Power steering warning



SNOW indicator  
(Automatic Transmission)

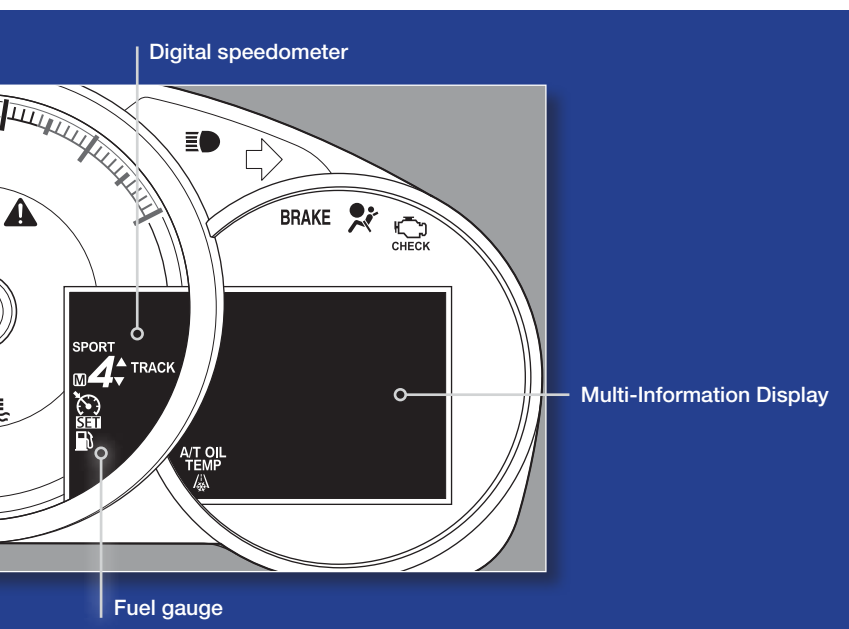

Slip indicator

**TRACK**

TRACK indicator



VSC off



Keyless Access with Push Button Start System

CHECK engine/  
Malfunction indicator

Turn signals



Tire pressure warning light



Front fog light indicator light (if equipped)



Front passenger frontal airbag OFF/ON



Cruise control indicator light



Headlight leveler (if equipped)

**SET**

Cruise control set indicator light



TRAC OFF indicator

**SPORT**

SPORT indicator (Automatic Transmission)



Incline start assist

# Personalize

## Tilt Steering Column

Push the lever down firmly to adjust the height position of the column; firmly push the lever back up to lock the column in place. Do not adjust while driving.



## Power Exterior Mirrors

Turn the knob to the "L" to adjust the left-hand mirror or to the "R" to adjust the right-hand mirror. Move the knob in the direction you want to move the mirror. Then return the knob to the neutral/center position.



## HomeLink® 5 Accessory Mirror (if equipped)

The HomeLink 5 accessory mirror provides three buttons to replace up to three hand-held radio frequency remotes used to activate devices such as garage door openers, gate openers, entry door locks, security systems and home lighting. Please see your Owner's Manual for programming instructions or visit [www.subaru.com/homelink](http://www.subaru.com/homelink) to view a how-to video.



## Trunk Lid Cancel Button

Prevent unauthorized entry into the trunk by locking the trunk release lever. Press the trunk lid cancel button to lock the trunk release lever. The trunk can only be opened using the master key. Press the button in to unlock the trunk release lever.



## km/h - MPH, ODO - TRIP and DISP Buttons

1. Press this button to change the digital display from km/h to MPH. Press again to switch back.
2. Press this button to cycle through the odometer, trip meter A, trip meter B, the setting screen for the tachometer needle or the setting screen for the shift position indicator.
3. For BRZ Premium, press this button to cycle through the outside temperature, current fuel consumption or average fuel consumption. For BRZ Limited, see page 17.

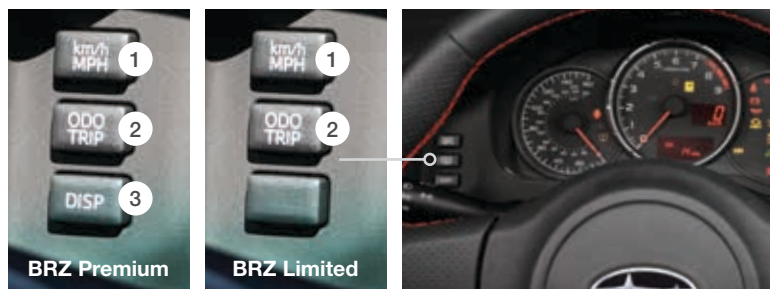

# Controls

## Light Controls

Push forward to change from low beam to high beam. Pull the lever back to center to return to low beam.

Turns on headlights, instrument panel illumination, parking lights, tail lights and license plate lights.

Push up for right turn signal.

Push down for left turn signal.

Turns on fog lights (if equipped).

AUTO (if equipped): The vehicle's lights are automatically on or off, depending on the level of outside light.

Turns on instrument panel lights, tail lights, parking lights and license plate lights.

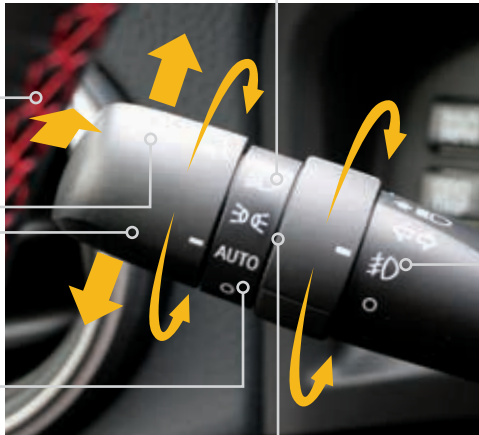

While the light switch is on, rotate the dial downward to dim the instrument panel illumination. Rotate the dial upward to make the illumination brighter. When the dial is fully rotated upward, the instrument panel illumination becomes full bright.







## Windshield Wipers

To turn on the wipers, press the wiper control lever down one level for intermittent, two levels for low, or three levels for high speed. Return the lever to the “OFF” position to stop the wipers. For a single wipe, move the lever up. To spray washer fluid, pull and hold the lever toward you.

## Daytime Running Lights

Daytime running lights are standard on your vehicle. Only a reduced brightness high beam will be automatically turned on when the engine has started, the parking brake is fully released and the light switch is in the “OFF” or “” position. The brightness of the illumination of the high beam headlights is reduced by the daytime running light system. You must always switch on your headlights when it is dark outside by turning the light switch to the “” position.

# Controls



## Manual Climate Control

### 1. Air Flow Control Dial

The air flow control dial allows you to choose the direction of air flow. Rotate the dial for the desired air flow position.

#### Defrost/Defog

To clear the windshield and front door windows of fog or frost, rotate the air flow control dial to the defrost position, set the temperature control to the red position, and set the fan speed control to the fastest speed.

### 2. Rear Window Defogger Button

Press the rear window defogger button to turn on the defogger. The defogger will automatically shut off after about 15 minutes. If the window clears before that time, you can press the button again to turn it off.

### 3. Fan Speed Control Dial

Rotate the fan speed control dial to select one of four fan speeds.

### 4. Air Conditioning Button

Press the "A/C" button to activate the air conditioning. Press it again to turn off the air conditioning.

### 5. Recirculated/Outside Air Button

Press the air inlet selection button to prevent outside air from being drawn into the passenger compartment. If the button is pushed in, press it again to draw outside air into the compartment. TO PREVENT WINDSHIELD FOGGING, DO NOT REMAIN IN THE RECIRCULATED MODE FOR AN EXTENDED PERIOD OF TIME.

### 6. Temperature Control Dial

Rotate the temperature control dial from blue for cool, to red for warm.





## Dual Zone Automatic Climate Control System (if equipped)

### 1. Automatic On and Off

This system automatically controls outlet air temperature, fan speed, air flow distribution, air inlet control, and air conditioner compressor operation. Press “AUTO” to activate. Push “OFF” to turn off the system.

### 2. Temperature Control Dials

Rotate the dial to select a temperature and maintain a comfortable climate within the driver and passenger compartment. Temperature is displayed digitally on the screen. Separate temperature settings can be adjusted for the driver’s side and passenger’s side.

### Operation in Manual Mode

#### 3. Recirculated/Outside Air Switch

Push the air inlet selection switch to prevent outside air from being drawn into the passenger compartment. Push the switch again to allow outside air into the compartment. TO PREVENT WINDSHIELD FOGGING, DO NOT REMAIN IN THE RECIRCULATED MODE FOR AN EXTENDED PERIOD OF TIME.

### 4. Fan Speed Control Dial

In the automatic setting, the system determines the fan speed to achieve the desired temperature, or you can manually rotate the fan speed control dial to select one of seven fan speeds.

### 5. Air Flow Mode Selection Button

Press the button to select the desired air flow mode. The selected air flow mode is shown on the display above.

### 6. Dual Mode Switch

Push the “DUAL” switch to activate or deactivate the dual mode. Dual mode makes it possible to have separate temperature settings for the driver’s side and passenger’s side.

### 7. Air Conditioner Switch

Push the “A/C” switch to activate the air conditioning. Push it again to turn off the air conditioning.

### 8. Front Defroster Button

Press the button to defrost or dehumidify the windshield and front door windows.

### 9. Rear Window Defogger Switch

Push the switch to turn on the defogger. It will automatically shut off after about 15 minutes. If the window clears before that time, you can push the switch again to turn it off.

# Controls

## Steering Wheel Audio Controls (if equipped)

Press the button to select the desired audio mode — FM, AM, SAT, CD, AUX, MEDIA.



Press to mute or cancel mute in FM, AM, SAT or AUX. Press to pause or play in CD or USB.

Press the top (+) of the switch to increase volume or the bottom (-) of the switch to decrease volume.

With any of the radio modes selected, push the switch left or right to skip through your presets. In CD mode, push the switch left or right to skip forward or back a track.

## Multi-Information Display Control Switches (if equipped)

For more information about the meter control switches, please refer to the “Multi-information display (color display)” section in your Owner’s Manual.



Enter button.

Press to return to the previous screen.

Press the switch left or right to select menu icons.

Press the top or bottom of the switch to change the displayed content, scroll up or down, or move the cursor.

# Controls

## Driving Systems/Modes

To help enhance driving safety and performance, the following systems operate automatically in response to various driving situations.

1. If the vehicle gets stuck in mud, dirt or snow, the traction control system may reduce power from the engine to the wheels. Turning the system off may make it easier for you to rock the vehicle in order to free it. Press the button again to turn the traction control back on.
2. Your vehicle may be equipped with two types of control modes to accommodate various driving preferences. The control modes can be selected with the "TRACK" button. Normal mode allows secure and smooth normal driving. When the button is pressed and held for one second, TRACK mode is activated. The driving threshold parameters are raised allowing the driver more control over the vehicle.
3. If equipped, push the switch toward the "SPORT" mode for sporty driving or when driving in mountainous regions with lots of

curves. To cancel sport mode, push the switch toward "SPORT" mode again.

If equipped, push the switch toward the "SNOW" mode for accelerating and driving on slippery road surfaces, such as snow. To cancel snow mode, push the switch toward "SNOW" mode again.

For more detailed information, please refer to your Owner's Manual.



## USB Port (if equipped)

The USB port is located underneath the climate controls. You can connect a USB-equipped portable music player to the USB port and hear the music stored on it through the vehicle speakers. Press the "SOURCE" button located on the audio system repeatedly until the USB mode is selected.



## Auxiliary Input Jack

The 3.5 mm auxiliary input jack is located underneath the USB port. You can connect a portable music player to the auxiliary jack and hear the music stored on it through the vehicle speakers. Press the "SOURCE" button located on the audio system to select the auxiliary mode.



## Cruise Control

To resume your speed after canceling, push the lever up to the “RES” side.

To cancel the cruise control, pull the lever toward you, push the brake pedal or press the “ON-OFF” button. If you have a manual transmission, you can push in the clutch pedal.



Press the accelerator pedal until your vehicle reaches the desired speed. Push the lever down to the “SET” side and release. Ease off the accelerator pedal. Your vehicle will maintain the desired speed.

To activate the cruise control, press the “ON-OFF” button. The cruise control indicator light on the instrument panel will turn on. To deactivate cruise control, press the “ON-OFF” button again.

### Increase speed

Push the lever up to the “RES” side; hold until your vehicle reaches the desired speed and release. To increase speed using the accelerator pedal, press the pedal until you reach the desired speed. Push the lever down to the “SET” side to set the speed.

### Decrease speed

Push the lever down to the “SET” side; hold until your vehicle slows to the desired speed and release. To decrease the speed using the brake pedal, press the pedal to release cruise control temporarily. When the speed decreases to the desired speed, push the lever down to the “SET” side to set the speed.

# While Operating

## Trunk Lid Opener

To open the trunk, press the trunk lid opener switch.



## Paddle Shift Control Switches (if equipped)

- Temporary use: Even when the selector is in the “D” (Drive) position, you can temporarily shift the gear by pulling the “+” or “-” paddle shift control switch. The transmission will automatically switch back to Normal Mode.
- When the selector lever is in Manual Mode, shift to the next higher gear by pulling the “+” paddle shift control switch on the steering wheel. Pull the “-” paddle shift control switch to shift into the next lower gear.



## When Manual Shifting Operation is Possible

- Arrow-shaped lights in the center of the instrument panel show whether an upshift is possible and whether a downshift is possible.

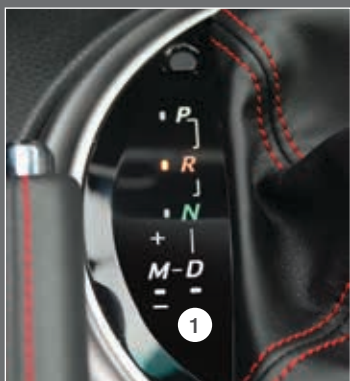

## Automatic Transmission Shift Mode

The automatic transmission gives you ultimate control with two different driving modes: Normal Mode and Manual Mode.

### Normal Mode

When the selector lever is in the “D” (Drive) position, the transmission is in Normal shift mode. The shift position indicator on the instrument panel shows “D” and the transmission automatically shifts into a suitable forward gear.

### Manual Mode

In Manual Mode, you select the desired gear position to obtain necessary acceleration and engine braking. Moving the selector lever left into the manual gate ① from the “D” (Drive) position causes the transmission to change into Manual Mode. To shift, use the paddle shift control switches or gear lever. The shift position indicator shows the selected gear position.

# Safety/In Case of Emergency

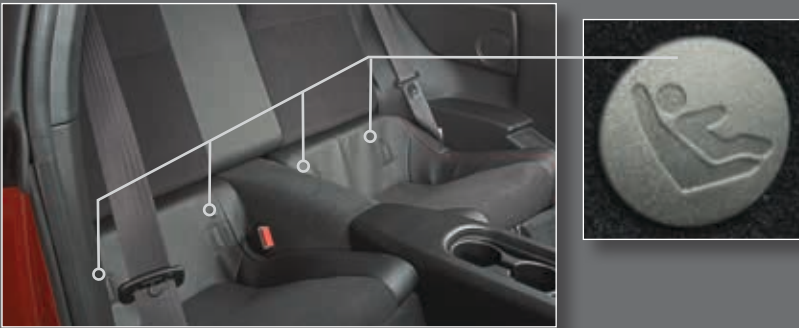

## Child Restraint System

For maximum safety, first carefully read the LATCH system instructions from the device manufacturer, as well as the installation instructions in your Owner's Manual, to properly install the LATCH compatible child restraint system. Use the appropriate seatbelts or anchorages provided in your vehicle. Children age 12 and under must properly occupy the rear seat at all times.

## Internal Safety Trunk Release with Self-Illuminating Handle

In the event that children or adults become locked inside the trunk, this luminescent handle allows them to open the lid from inside the trunk. To open, simply pull the yellow handle downward as indicated by the arrow on the handle, and then push up on the lid.







## Location of Spare Tire and Jack

A spare tire, jack, jack handle, towing eyelet, screwdriver and wheel nut wrench are stored under the floor of the trunk.

## Subaru Roadside Assistance

Subaru Roadside Assistance is free and standard on every 2017 BRZ vehicle. Coverage is automatic; there are no forms to complete. Subaru Roadside Assistance is available anytime during the 3-year/36,000-mile Subaru Limited Warranty, whichever comes first.\* A Subaru Roadside Assistance decal has been affixed to the driver's door window.

Subaru Roadside Assistance: 1-800-261-2155

### Exclusions

Specifically excluded from Subaru Roadside Assistance coverage are service requests or claims resulting from: accidents, vandalism, acts of God, violation of any laws, misuse and abuse, or vehicle modifications not recommended by the manufacturer.

\*See your retailer for details.

# Additional Information

## Fuel

Use premium unleaded gasoline with an octane rating of 91 AKI or higher. Consult the Owner's Manual for more detailed information.

## Fuel Capacity

- 13.2 US gal (50 liters, 11 Imp gal)
- When the low fuel indicator light is displayed on the instrument panel, approximately 1.8 US gal (7.0 liters, or 1.5 Imp gal) of fuel remain.
- If you have recently fueled your vehicle, the check engine light on the instrument panel may stay on due to a missing or loose fuel filler cap (the cap should be tightened until a click is heard).

## Fuel Filler Lid Release

The fuel filler lid release is located on the floor to the left of the driver's seat. To open the fuel filler lid, pull the fuel filler lever up and release.



## Engine Oil

Use only the following oils:

- ILSAC GF-5, which can be identified with the ILSAC certification mark (Starburst mark).
- Or API classification SN with the words “RESOURCE CONSERVING.”
  - Use 0W 20 synthetic, replacement interval 6,000 miles under normal driving conditions. No requirement at the first 3,000 miles.

## Engine Oil Capacity

- Without filter: 5.5 US qt (5.2 liters, 4.6 Imp qt)
- With filter: 5.7 US qt (5.4 liters, 4.8 Imp qt)

# Engine Compartment

Please refer to your Owner's Manual for more information.

## BRZ Premium and BRZ Limited with Manual Transmission



**Note:** Callouts apply to both engines.

- |                           |                              |                  |
|---------------------------|------------------------------|------------------|
| 1. Brake Fluid Reservoir  | 4. Air Cleaner Element       | 7. Radiator Cap  |
| 2. Windshield Washer Tank | 5. Engine Coolant Reservoir  | 8. Main Fuse Box |
| 3. Engine Oil Filler Cap  | 6. Engine Oil Level Dipstick | 9. Battery       |

## BRZ Limited with Automatic Transmission

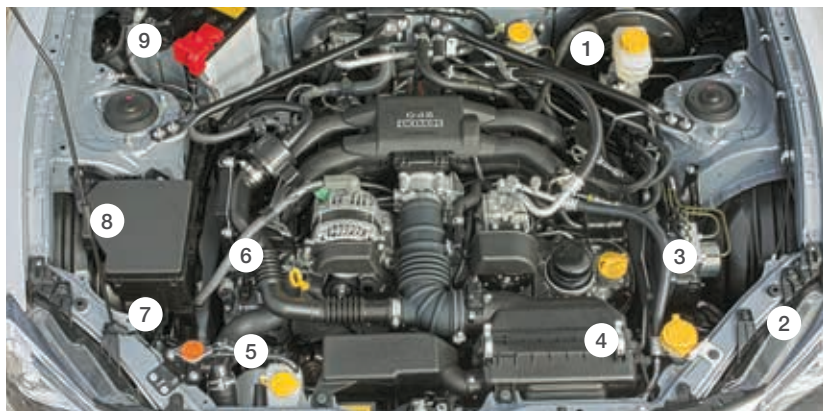





# Vehicle Delivery Checklist

## Delivery Information

V.I.N. \_\_\_\_\_

Delivery Date \_\_\_\_\_

Owner(s) \_\_\_\_\_

Phone: \_\_\_\_\_

Email: \_\_\_\_\_

## Registration & Appointment

MySubaru  Enrolled

1st Service Appointment  Initiated

## Manuals & Warranties

- Review vehicle manuals & maintenance schedule
- Review warranty information  
(Basic, Powertrain, Tire, Wear Items & Adjustments)
- Review Subaru Roadside Assistance 1 (800) 261-2155

## Retailer Orientation

- Parts & Service departments locations & hours
- Service Advisor introduction and/or business card
- Service appointment & Early Bird  
drop-off procedures

## Vehicle Condition

- Exterior/Interior is clean and undamaged
- Verify that all equipment, accessories and options  
are present

Note any exceptions: \_\_\_\_\_

\_\_\_\_\_

\_\_\_\_\_

\_\_\_\_\_

## Steering Wheel & Instrument Panel

- Master and Valet Keys, Keyless Access System\* operation, Push Button Start\* and Remote Start\*
- Tilt/Telescopic Steering Column Adjustments and Paddle Shift operation\*
- Steering Wheel Controls
- Headlights, DRL, Parking Lights, Hazard Lights, Interior Lights, Fog Lights\*, Autolights\* and Welcome / Goodbye Lighting\*
- Front & Rear\* Wiper and Washer Controls
- Gauges, Warning Lights, Multi Function Display\*, Information Display settings and Parking Brake operation

## STARLINK Audio System and Bluetooth

- Bluetooth - Pair owner's phone(s) & show operation (Download MySubaru App\*)
- STARLINK Audio system controls (Sources, Presets, List & Back buttons)

## Safety, Comfort & Convenience

- All Wheel Drive System, Emergency towing of AWD, VDC, X-Mode\* and Hill Holder\* operation
- Rear Vision Camera
- All Weather Package operation - Heated Seats, Exterior Mirrors & Windshield Wiper De-icer
- Review operation of climate control system
- Power windows, locks, exterior mirrors, seat including Memory Function\* and Power Moonroof\* operation
- Hood Release and fluid reservoir locations
- Fuel Filler Door, Trunk Release, Rear Gate operation and location of Spare Tire\*, Jack & Tools

## Driver Assist Technology

- Subaru EyeSight™ System\*, Steering Responsive Foglights\* and Steering Responsive Headlights\*
- Reverse Automatic Braking System\*
- Blind Spot Detection\*, Lane Change Assist\* and Rear Cross Traffic Alert\*
- High Beam Assist\*

\*If Applicable

Owner Signature(s) \_\_\_\_\_

Subaru Sales Consultant \_\_\_\_\_

Subaru Sales Manager \_\_\_\_\_



Subaru of America, Inc., Subaru Plaza,  
P.O. Box 6000, Cherry Hill, NJ 08034-6000



MSA5B1706A  
Issued September 2016  
Printed in USA 09/16

