

# CROSSTREK

2016

## Quick Reference Guide



Love. It's what makes a Subaru, a Subaru.



Complete U.S. specifications and illustrations may not have been available at time of publication. Specifications are based on the latest product information available at time of publication. Some images shown are for illustration purposes only. Some equipment shown may be optional at extra cost. Specific options may be available only in combination with other options. Specific combinations of equipment or features may vary from time to time and by geographic area. Certain accessories and equipment may not be available at the time of publication.

This Quick Reference Guide applies to all Crosstrek models. Therefore, some explanations may be for equipment not installed on your vehicle. Subaru of America, Inc., reserves the right to change or discontinue at any time, without notice, prices, colors, materials, equipment, accessories, specifications, models and packages without incurring any obligation to make the same or similar changes on vehicles previously sold. Colors shown may vary due to reproduction process.

For detailed operating and safety information, please consult the Owner's Manual.

Subaru, Outback, Legacy, Forester, Impreza, WRX, WRX STI, Crosstrek, BOXER, SI-DRIVE, Lineartronic, Alcantara, EyeSight, HD Radio, Aha Radio, and SiriusXM are registered trademarks. SUBARU STARLINK is a trademark of Fuji Heavy Industries, Ltd.

All rights reserved. Contents may not be reprinted or electronically reproduced in whole or in part without prior written approval of Subaru of America, Inc.

© 2015 Subaru of America, Inc.

# Table of Contents

---

2-3	<b>Getting Started</b>
4-5	<b>Instrument Panel</b>
6-9	<b>Gauges</b>
10-11	<b>Personalize</b>
12-19	<b>Controls</b>
20-21	<b>While Operating</b>
22-23	<b>Safety/In Case of Emergency</b>
24-25	<b>Additional Information</b>

# Remote Keyless Entry

## 1. Lock/Arm

- Press to lock all doors and the rear gate and activate the security alarm.
- If any of the doors or the rear gate are not fully closed, an electronic chirp will sound and the hazard lights will flash to alert you that the doors or the rear gate are not properly closed.
- To activate the vehicle finder function, press three times (within five seconds). If you are within 30 feet of the vehicle, the horn will sound one time and the hazard lights will flash three times.

## 2. Unlock/Disarm

- Press once to unlock the driver's door.
- Press twice (within five seconds) to unlock all doors.
- When the "Unlock/Disarm" button is pressed, the dome and map lights will illuminate if the dome light switch is in the middle position.

## 3. Unlocking the Rear Gate

- Press the button to unlock the rear gate. An electronic chirp will sound twice and the hazard lights will flash twice.

## 4. Panic Alarm

- Press once and the horn will sound and the hazard lights will flash.
- Press any button on the remote to deactivate.



## Keyless Access with Push Button Start System (if equipped)

By simply carrying the access key in your pocket, you can lock and unlock doors, open the rear gate and start your car without ever having to take the key fob out of your pocket.

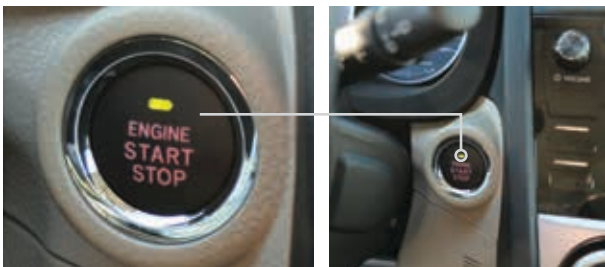

# Seating

## Heated Seats (if equipped)

Press the switch in the corresponding direction for the desired seat temperature. To turn off the seat heater, slightly press in the opposite direction of the current position.



## Seat Controls

### 1. Forward/Backward

Pull up on the lever below the front of the driver's seat to move the seat forward or backward.

### 2. Raise/Lower Seat Cushion

To adjust the height of the driver's seat, pull up or push down the seat height adjustment lever, located on the lower left side front of the seat.

### 3. Recline Seatback

To adjust the seatback to the desired position, pull up on the recline lever, located on the lower left rear of the driver's seat or lower right rear of the passenger's seat. Do not adjust seats while driving.



## Folding the Rear Seat

Lower the headrests. Pull up on the release knob on the seat side that you want to fold down. To return the seatback to its original position, raise the seatback until it locks into place, making sure that it is securely locked.

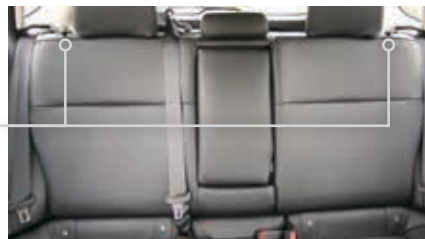

Instrument Panel

Gauges

Personalize

Controls

While Operating

Safety/In Case of Emergency

Additional Information

# Instrument Panel

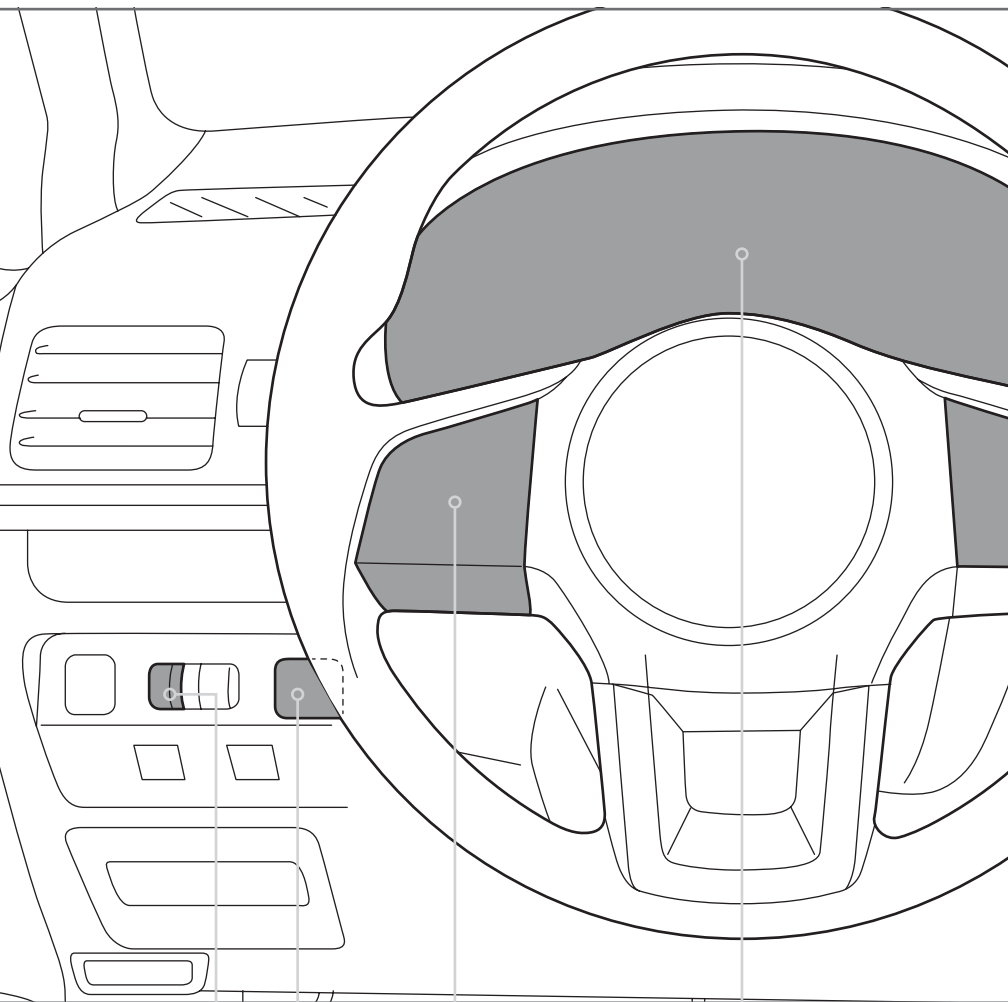

PAGE  
NUMBER

12

20

18

6-9

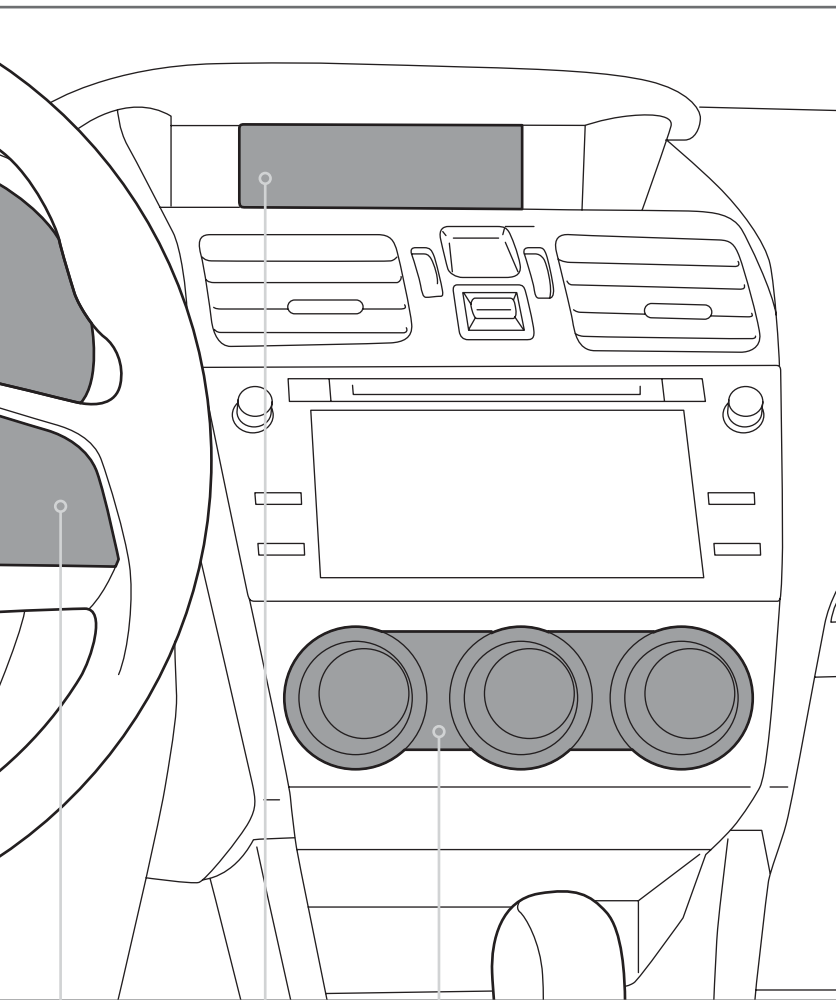

19

14-15

**Clock**

Press the “+” button to advance the time or the “-” button to reverse the time. Vehicles with a navigation system, please refer to the separate “Operating Instructions for Navigation System.”

# Gauges - Vehicles without EyeSight

Trip meter A/B selection and trip meter reset knob

Trip meter and odometer

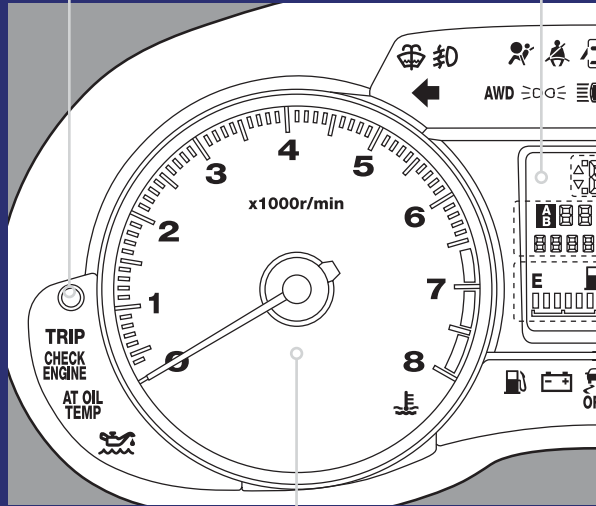

- Immediate Attention
- Caution
- ■ Informational



Seatbelt warning



Brake system



Front passenger seatbelt warning



Hot coolant temperature / Cold coolant temperature



SRS airbag system



High beam indicator light



Security indicator light



AT OIL TEMP (Automatic Transmission)



Door open



ABS warning



Charge warning



Low fuel



Oil pressure warning



All-Wheel Drive (Automatic Transmission)



Power steering warning



Vehicle Dynamics Control / Vehicle Dynamics Control operation



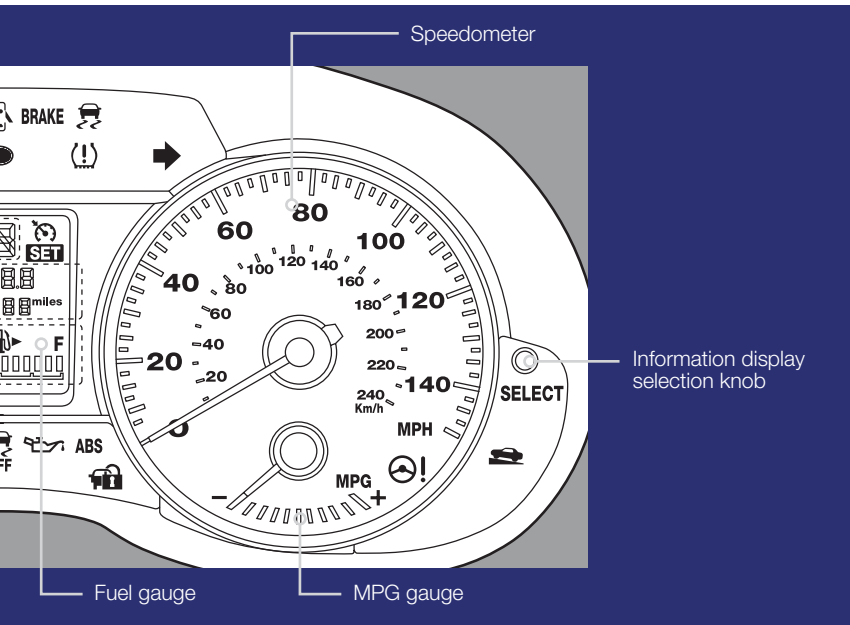

Vehicle Dynamics Control OFF



Turn signals



CHECK ENGINE /  
Malfunction indicator



Front fog light indicator  
light (if equipped)



Tire pressure warning light



Cruise control  
indicator light



Front passenger frontal  
airbag ON



Cruise control set  
indicator light



Front passenger frontal  
airbag OFF



Engine oil level warning light



Windshield washer  
fluid warning



Incline Start Assist

# Gauges - Vehicles with EyeSight

Trip meter A/B selection and trip meter reset knob

Tachometer

Fuel gauge

- Immediate Attention
- Caution
- ■ Informational

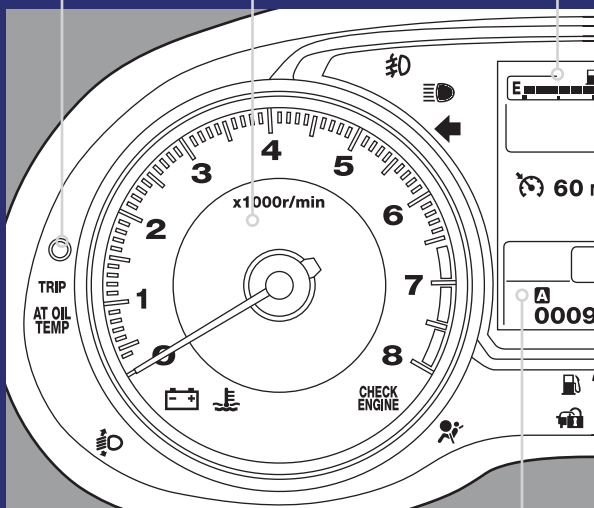

Trip meter and odometer



Seatbelt warning

**BRAKE** /

Brake system

PASSENGER



Front passenger seatbelt warning



Hot coolant temperature / Cold coolant temperature



SRS airbag system



High beam indicator light



Security indicator light

**AT OIL TEMP**

AT OIL TEMP (Automatic Transmission)



Door open

**ABS** /

ABS warning



Charge warning



Low fuel



Oil pressure warning

**AWD**

All-Wheel Drive (Automatic Transmission)



Power steering warning



Vehicle Dynamics Control / Vehicle Dynamics Control operation

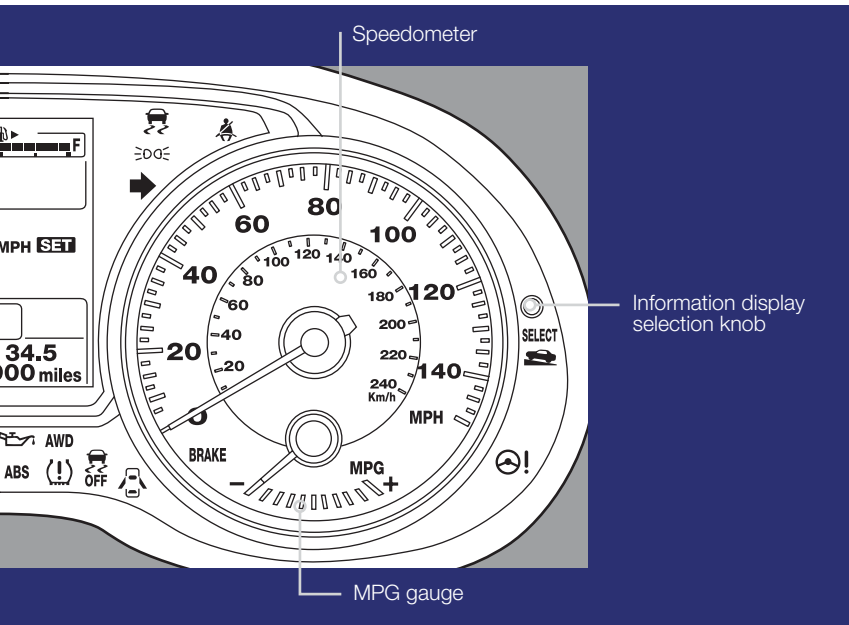

Vehicle Dynamics Control OFF



Turn signals



CHECK ENGINE /  
Malfunction indicator



Front fog light indicator  
light (if equipped)



Tire pressure warning light



Cruise control  
indicator light



Front passenger frontal  
airbag ON



Cruise control set  
indicator light



Front passenger frontal  
airbag OFF



Engine oil level warning light



Windshield washer  
fluid warning



Incline Start Assist

# Personalize

## Tilt and Telescopic Steering Column

Push the lever down firmly to adjust the height and lengthwise position of the column; firmly push the lever back up to lock the column in place. Do not adjust while driving.



## Power Exterior Mirrors

Turn the knob to the “L” side to adjust the left-hand mirror or to the “R” side to adjust the right-hand mirror. Move the knob in the direction you want to move the mirror. Then return the knob to the neutral/center position.



# Controls

## Light Controls

Push forward to change from low beam to high beam. Pull the lever back to center to return to low beam.

Push up for right turn signal.

Turns on headlights, instrument panel illumination, parking lights, tail lights and license plate lights.

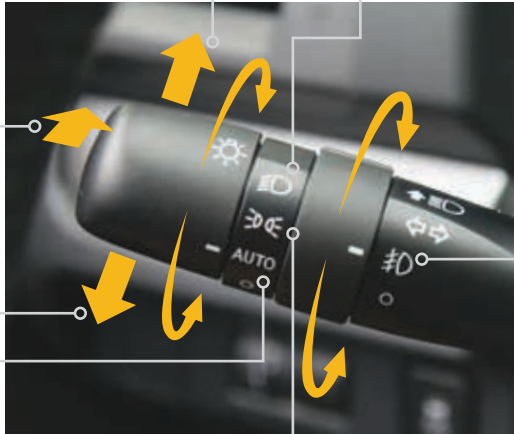

Push down for left turn signal.

Turns on fog lights (if equipped).

AUTO (if equipped): The vehicle's lights are automatically on or off, depending on the level of outside light.

Turns on instrument panel lights, tail lights, parking lights and license plate lights.

While the light switch is on, rotate the dial downward to dim the instrument panel illumination. Rotate the dial upward to make the illumination brighter. When the dial is fully rotated upward, the instrument panel illumination becomes full bright.





## Windshield Wipers

To turn on the wipers, press the wiper control lever down one level for intermittent, two levels for low, or three levels for high speed. Return the lever to the "OFF" position to stop the wipers. For a single wipe, move the lever up. To spray washer fluid, pull and hold the lever toward you.

To operate the rear wiper, rotate the end of the knob upward to the intermittent, continuous, or wash position. When the rear wiper is off, rotate the knob downward to wash and wipe the rear window.

## Daytime Running Lights

Daytime running lights are standard on your vehicle. Only a reduced brightness high beam will be automatically turned on when the engine has started, the parking brake is fully released and the light switch is in the "OFF" or "☞☞☞" position. The brightness of the illumination of the high beam headlights is reduced by the daytime running light system. You must always switch on your headlights when it is dark outside by turning the light switch to the "☞☞☞" position.

# Controls



## Manual Climate Control System (if equipped)

### 1. Air Flow Control Dial

The air flow control dial allows you to choose the direction of air flow. Rotate the dial for the desired air flow position.

#### Defrost/Defog

To clear the windshield and front door windows of fog or frost, rotate the air flow control dial to the defrost position, set the temperature control to the red position, and set the fan speed control to the fastest speed.

### 2. Rear Window Defogger Button

Press the rear window defogger button to turn on the defogger. The defogger will automatically shut off after about 15 minutes. If the window clears before that time, you can press the button again to turn it off.

### 3. Fan Speed Control Dial

Rotate the fan speed control dial to select one of four fan speeds.

### 4. Recirculated/Outside Air Button

Press the air inlet selection button to prevent outside air from being drawn into the passenger compartment. If the button is pushed in, press it again to draw outside air into the compartment. **TO PREVENT WINDSHIELD FOGGING, DO NOT REMAIN IN THE RECIRCULATED MODE FOR AN EXTENDED PERIOD OF TIME.**

### 5. Temperature Control Dial

Rotate the temperature control dial from blue for cool, to red for warm.

### 6. Air Conditioning Button

Press the "A/C" button to activate the air conditioning. Press it again to turn off the air conditioning.



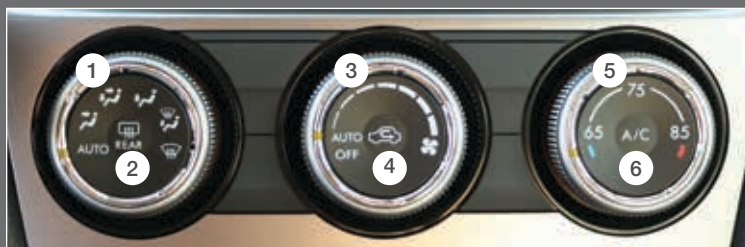

## Automatic Climate Control System (if equipped)

### 1. Air Flow Control Dial

In the automatic setting, the system determines the air flow location to achieve the desired temperature, or you can manually choose the direction of air flow. Rotate the dial for the desired air flow position.

#### Defrost/Defog

To clear the windshield and front door windows of fog or frost, rotate the air flow control dial to the defrost position, set the temperature control to the red position, and set the fan speed control to the fastest speed.

### 2. Rear Window Defogger Button

Press the rear window defogger button to turn on the defogger. The defogger will automatically shut off after about 15 minutes. If the window clears before that time, you can press the button again to turn it off.

### 3. Fan Speed Control Dial

In the automatic setting, the system determines the fan speed to achieve the desired temperature, or you can manually rotate the fan speed control dial to select one of seven fan speeds.

### 4. Recirculated/Outside Air Button

In the automatic mode, the system will determine if recirculated air is needed to achieve a desired temperature. In manual mode, press the air inlet selection button to prevent outside air from being drawn into the passenger compartment. If the button is pushed in, press it again to draw outside air into the compartment. TO PREVENT WINDSHIELD FOGGING, DO NOT REMAIN IN THE RECIRCULATED MODE FOR AN EXTENDED PERIOD OF TIME.

### 5. Temperature Control Dial

Rotate the temperature control dial from 65 for cool to 85 for warm.

### 6. Air Conditioning Button

Press the "A/C" button to activate the air conditioning. Press it again to turn off the air conditioning.

# Controls

## Power Moonroof (if equipped)

With the moonroof in the fully closed position, press the switch ① to tilt the moonroof up. Press and hold the switch ② to lower the moonroof. Press and hold the switch ③ to fully open the moonroof. Press and hold the switch ④ to close the moonroof. To stop the moonroof in a midway position while opening or closing, momentarily press the switch to side ③ or side ④.

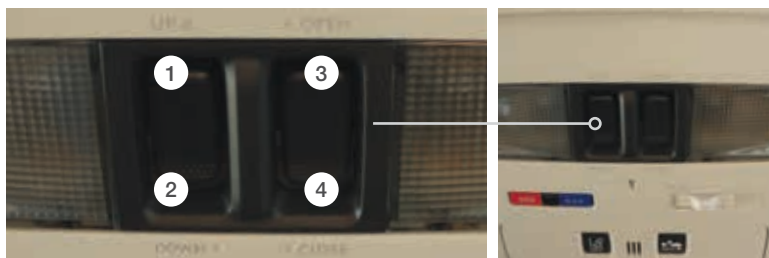



## Auxiliary Input Jack

The 3.5mm auxiliary input jack is located in the front of the center console. You can connect a portable music player to the auxiliary jack and hear the music stored on it through the vehicle speakers. Press the “SOURCE” button located on the audio system to select the auxiliary mode.

## USB Port

The USB port is located in the front of the center console. You can connect a portable music player to the USB port and hear the music stored on it through the vehicle speakers. Press the “SOURCE” button located on the audio system repeatedly until the USB mode is selected.

# Controls

## Steering Wheel Audio Controls

Push the top (+) of the switch to increase or the bottom (-) of the switch to decrease volume.

Press to turn audio ON/OFF or to select the cursor entry.

With any of the radio modes selected, push the switch left or right to skip through your presets. In CD mode, push the switch up or down to skip forward or back a track.





Press the button to show the list screen.

Press the button to return to the previous screen.

Press the button to select the desired audio mode — FM, AM, SAT, CD, AUX, MEDIA.

Talk switch; please refer to the "Bluetooth audio" section in your Owner's Manual.

## Cruise Control

To activate the cruise control, press the “” button. The indicator light on the instrument panel will turn on. To deactivate cruise control, press the “” button again.

To resume your speed after canceling, push the switch to the “RES” side.



To cancel the cruise control, push the brake pedal or press the “CANCEL” button. If you have a manual transmission, you can push in the clutch pedal.

Press the accelerator pedal until your vehicle reaches the desired speed. Push the switch to the “SET” side and release. Ease off the accelerator pedal. Your vehicle will maintain the desired speed.

### Increase Speed

Push up the “RES/SET” switch to the “RES” side; hold until your vehicle reaches the desired speed and release. To increase speed using the accelerator pedal, press the pedal until you reach the desired speed. Push down the “RES/SET” switch to the “SET” side to set the speed.

### Decrease Speed

Push down the “RES/SET” switch to the “SET” side; hold until your vehicle slows to the desired speed and release. To decrease the speed using the brake pedal, press the pedal to release cruise control temporarily. When the speed decreases to the desired speed, push down the “RES/SET” switch to the “SET” side to set the speed.

# While Operating

## Vehicle Dynamics Control OFF Switch

Pressing the switch to deactivate the Vehicle Dynamics Control system can help in the following situations:

- A standing start on a steeply sloping road with a snowy, gravel-covered, or otherwise slippery surface.
- When the vehicle's wheels are stuck in mud or deep snow.



## Fuel Filler Lid Release

The vehicle is equipped with a fuel filler lid release. To open the fuel filler lid, pull the fuel filler lever up and release.

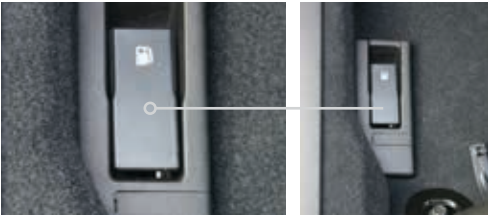

## Paddle Shift Control Switches (if equipped)

- Temporary use: Even when the selector is in the "D" (Drive) position, you can temporarily shift the gear by pulling the "+" or "-" paddle shift control switch. The transmission will automatically switch back to Normal Mode.
- When the selector lever is in Manual Mode, shift to the next higher gear by pulling the "+" paddle shift control switch on the steering wheel. Pull the "-" paddle shift control switch to shift into the next lower gear.





## Automatic Transmission Shift Mode

The automatic transmission gives you ultimate control with two different driving modes: Normal Mode and Manual Mode.

### Normal Mode

When the selector lever is in the “D” (Drive) position, the transmission is in Normal shift mode. The shift position indicator on the instrument panel shows “D”, and the transmission automatically shifts into a suitable forward gear.

### Manual Mode

In Manual Mode, you select the desired gear position to obtain necessary acceleration and engine braking. Moving the selector lever left into the manual gate ① from the “D” (Drive) position causes the transmission to change into Manual Mode. To shift, use the paddle shift control switches. The shift position indicator shows the selected gear position.

## When Manual Shifting Operation is Possible

- Arrow-shaped lights in the center of the instrument panel show whether an upshift is possible and whether a downshift is possible.
- Both arrows are on: Upshifting and downshifting are both possible.
- Up arrow only is on: Only upshifting is possible.
- Down arrow only is on: Only downshifting is possible.

# Safety/In Case of Emergency



## Child Restraint System

For maximum safety, first carefully read the LATCH system instructions from the device manufacturer, as well as the installation instructions in your Owner's Manual, to properly install the LATCH compatible restraint system. Use the appropriate seatbelts or anchorages provided in your vehicle. Children age 12 and under must properly occupy the rear seat at all times.

## Child Safety Locks

The child safety locks are located on the inside edges of the rear doors. In the locked position, the rear doors can only be opened from the outside.







## Location of Spare Tire and Jack

A jack handle is stored under the floor of the cargo area. A jack and a towing hook are stored in the tool bucket in the center of the spare tire. Also, a tool bag that contains a wheel nut wrench and a screwdriver is equipped with the vehicle.

## Emergency Towing Your All-Wheel Drive Vehicle

Since Subaru Symmetrical All-Wheel Drive distributes engine power to all four wheels, improper towing will severely damage your AWD system. A flatbed truck is the only recommended way to properly transport your AWD vehicle. If towing is necessary, it is best done by your Subaru retailer or a commercial towing service.

## Subaru Roadside Assistance

Subaru Roadside Assistance is free and standard on every 2016 Subaru vehicle. Coverage is automatic; there are no forms to complete. Subaru Roadside Assistance is available anytime during the 3-year/36,000-mile Subaru Limited Warranty, whichever comes first.\* A Subaru Roadside Assistance decal has been affixed to the driver's door window.

Subaru Roadside Assistance:  
1-800-261-2155

### Exclusions

Specifically excluded from Subaru Roadside Assistance coverage are service requests or claims resulting from: accidents, vandalism, acts of God, violation of any laws, misuse and abuse, or vehicle modifications not recommended by the manufacturer.

\*See your retailer for details.

# Additional Information

## Fuel

- Use regular unleaded gasoline with an octane rating of 87 AKI or higher. Consult the Owner's Manual for more detailed information.

## Fuel Capacity

- 15.9 US gal (60 liters, 13.2 Imp gal)
- When the low fuel indicator light is displayed on the instrument panel, approximately 2.6 US gal (10.0 liters, 2.2 Imp gal) of fuel remain.
- If you have recently fueled your vehicle, the Check Engine light on the instrument panel may stay on due to a missing or loose fuel filler cap (the cap should be tightened until a click is heard).

## Engine Oil

Use only the following oils:

- ILSAC GF-5, which can be identified with the ILSAC certification mark (Starburst mark).
- Or API classification SN with the words “ENERGY CONSERVING.”
  - Use 0W-20 synthetic, replacement interval 6,000 miles under normal driving conditions. No requirement at the first 3,000 miles.

## Engine Oil Capacity

- 5.1 US qt (4.8 liters, 4.2 Imp qt)







# Vehicle Delivery Checklist

## Delivery Information

V.I.N. \_\_\_\_\_

Delivery Date \_\_\_\_\_

Owner(s) \_\_\_\_\_

Phone # \_\_\_\_\_

Email \_\_\_\_\_

## Registration & Appointment

MySubaru/SUBARU STARLINK™ Registration

Enrolled  No Thanks

1st Service Appointment

Scheduled  No Thanks

## Manuals & Warranties

- Review vehicle manuals & maintenance schedule
- Review warranty information  
(Basic, Powertrain, Tire, Wear Items & Adjustments)
- Review Subaru Roadside Assistance 1 (800) 261-2155

## Retailer Orientation

- Parts & Service departments locations & hours
- Service Advisor introduction and/or business card
- Service appointment & "Early Bird"  
drop-off procedures

## Vehicle Condition

- Exterior/Interior is clean and undamaged
- Verify that all equipment, accessories and options  
are present

Note any exceptions: \_\_\_\_\_

\_\_\_\_\_

\_\_\_\_\_

## Steering Wheel & Instrument Panel

- Master and Valet Keys, Keyless Access System operation, Push Button Start\* and Remote Start\*
- Tilt/Telescopic Steering Column Adjustments and Paddle Shift operation\*
- Front & Rear\* Wiper and Washer Controls
- Headlights, DRL, Parking Lights, Hazard Lights, Interior Lights, and Fog Lights\*
- Gauges, Warning Lights, Multi Function Display\* settings and Parking Brake operation

## STARLINK Audio System & Bluetooth

- Bluetooth - Pair owner's phone(s) & show operation (Download SUBARU STARLINK and MySubaru Apps\*)
- STARLINK Audio\* and Navigation\* system controls (Sources, Presets, List & Back buttons)

## Safety, Comfort & Convenience

- All Wheel Drive System, Emergency towing of AWD, VDC, X-Mode\* and Hill Holder\* operation
- Rear Vision Camera\*
- All Weather Package operation - Heated Seats, Exterior Mirrors & Windshield Wiper De-icer
- Review operation of climate control system
- Power windows, locks, exterior mirrors, seat and Power Moonroof\* operation
- Hood Release and fluid reservoir locations
- Fuel Filler Door, Trunk Release, Rear Gate operation and location of Spare Tire\*, Jack & Tools

## Driver Assist Technology

- Subaru EyeSight™ System\* and SRF\*
- Blind Spot Detection\* and Rear Cross Traffic Alert\*

\*If Applicable

Owner Signature(s) \_\_\_\_\_

Subaru Sales Consultant \_\_\_\_\_

Subaru Sales Manager \_\_\_\_\_



Subaru of America, Inc., Subaru Plaza,  
P.O. Box 6000, Cherry Hill, NJ 08034-6000



MSA5B1607A  
Issued December 2015  
Printed in USA 12/15

