

Foreword

This supplement contains explanations and instructions for correctly operating the following systems.

- Navigation System
- Audio and Visual System
- Handsfree System
- APPS

If your vehicle contains one of the systems above, be sure to check the contents of this supplement carefully.

If you transfer the ownership of the vehicle to another person, make sure that this supplement is provided with the Owner's Manual inside the vehicle.

The information, specifications and illustrations in this supplement are valid at the time of publication. SUBARU CORPORATION reserves the right to change the specifications and design without prior notice, with no obligation to perform the same or equivalent changes to vehicles sold in the past.

This Owner's Manual supplement applies to all models, and describes all devices, including manufacturer-installed options. This means that information may be included about devices that are not installed in your vehicle.

Refer to P.14 for details on each of the different models.



SUBARU STARLINK is the "in-car connectivity system" available on select Subaru vehicles.

SUBARU CORPORATION, TOKYO, JAPAN

"SUBARU" and the six-star cluster design are registered trademarks of SUBARU CORPORATION.

©Copyright 2023, SUBARU CORPORATION

TABLE OF CONTENTS

1 Quick Guide

2 Basic Function

3 Settings

4 Phone

5 Apps

6 Audio

7 Navigation System (If equipped)

8 Voice Recognition System

9 Appendix/What To Do If/Index

· System Types... 14 · Dual 7.0-inch Display System... 15 · 11.6-inch Display System/11.6-inch Display With Navi System... 39

13

· Basic Information Before Operation... 68

67

· Registering A Bluetooth Phone/Device For The First Time... 80 · Registering A Bluetooth Phone/Device... 84
· Phone Settings... 83 · General Settings... 92 · Sound Settings... 98 · Radio Settings... 100

79

· Calling On The Bluetooth Phone... 110 · Receiving On The Bluetooth Phone... 113
· Talking On The Bluetooth Phone... 114 · Bluetooth Phone Message Function... 117

105

· SUBARU STARLINK... 127 · Apple CarPlay... 133 · Android Auto... 137 · SiriusXM Travel Link... 141

123

· Basic Operation... 150 · Radio Operation... 157 · Media Operation... 168 · Audio Remote Controls... 184

149

· Map Screen... 192 · Main Menu Screen... 199 · Route Guidance... 208 · Setup... 215
· SUBARU Map Update... 219

191

· Voice Recognition System Operation... 226

225

· Troubleshooting... 241 · Index... 251

235

INTRODUCTION

The symbols described below are found in this instruction manual as well as on the unit itself to ensure its proper and safe usage and to prevent injury or damage to property. Make sure you understand the meaning of these symbols before reading the rest of this manual.

READ FIRST

We recommend that you wait until the positioning stabilizes before starting to drive.

If you start to drive while the positioning is not complete, the indicated position may differ from the actual vehicle position.

The screens shown in this manual may differ from the actual screens depending on the data type or when the map data was created.

When maps are created, land surveys are conducted and information on road improvements and reopening is collected to provide the most accurate information possible. However, modifications to roads, place names and facilities may be carried out at any time. Consequently, we cannot guarantee that map data contains no errors in road positions, configuration and names, or in facility names.

Information in this manual that must be observed for the unit, and information that is useful to know is indicated as follows.

WARNING

- This sign indicates a situation in which incorrect handling through disregard of written information might result in death or serious personal injury.

CAUTION

- This sign indicates a situation in which incorrect handling through disregard of written information might result in personal injury or damage to property.

NOTE

- Useful information for the user is described.
- Be sure to read all materials such as manuals and warranties that come with the product. SUBARU CORPORATION is not responsible for problems that arise due to failure to follow these instructions.
- Changes to product specifications may result in differences between the content of the manual and the features of the unit.

SYMBOLS USED IN ILLUSTRATIONS

Safety symbol



The symbol of a circle with a slash through it means "Do not", "Do not do this" or "Do not let this happen".

Arrows indicating operations



 Indicates the action (selecting, turning, etc.) used to operate switches and other devices.

PRECAUTIONS FOR USE

WARNING

- The main unit requires a 12 V DC power supply. The main unit should not be installed in any vehicle which does not have a 12 V power system with a ground-connected negative side. An installation other than the one intended may cause severe damage to the main unit, and electric shock or serious injury to the users.
 - Even when using the route guidance of the navigation system, be sure to drive by following the actual traffic regulations. If you drive by following only the route guidance of the navigation system, you may violate the actual traffic regulations and cause a traffic accident.
 - To ensure safety, the driver should not operate the navigation system while driving. Operating the navigation system while driving may result in an accidental steering wheel operation or otherwise cause an accident. Stop the vehicle before operating the navigation system. Also, do not watch the screen while driving because doing so may be dangerous (ETC). Inattention to road conditions ahead may result in an accident.
 - The driver should not perform operations such as volume adjustment while driving. Inattention to road conditions ahead may result in an accident, so be sure to stop the vehicle in a safe place before performing the operation.
 - The driver should not perform operations such as adding a location or setting the memory while driving. Inattention to road conditions ahead may result in an accident, so be sure to stop the vehicle in a safe place before performing the operation.
- Before viewing a video, be sure to stop the vehicle in a safe place and apply the parking brake. To ensure safety, videos are not displayed during driving.
 - To ensure safety, never operate a cell phone while driving.
 - Do not disassemble or modify the unit. Doing so may result in an accident, fire or electric shock.
 - Do not let water or foreign objects enter the internal parts of the unit. Doing so may result in smoke, fire or an electric shock.
 - Do not use the unit when it is malfunctioning, such as when the screen is not lit or no sound comes out. Doing so may result in an accident, fire or electric shock.
 - Always replace fuses with fuses of the same specified capacity (amperage). Using a fuse with a higher capacity than the specification may result in a fire.
 - If a foreign object or water enters the unit, smoke or a strange odor may be emitted. If such an abnormality occurs, stop using the unit immediately and contact your SUBARU dealer. An accident, fire or electric shock may result if you continue to use the unit under these conditions.
 - In a thunderstorm, do not touch the antenna line or the unit. Lightning may cause an electric shock.
 - Do not park or stop in prohibited areas to use the unit.
 - If direct sunlight shines into the vehicle, light may reflect off the product. Be very careful while driving.
 - Never use headphones or earphones while driving. Driving while not being able to hear sounds from outside the vehicle may result in a traffic accident.

⚠ CAUTION

- Although the unit can be used when the ignition switch is set to either "ACC" or "ON" position, to protect the battery, start the engine before using the unit.
- Do not use the unit anywhere other than in a vehicle. Doing so may result in an electric shock or other injury.
- While driving, keep the volume low enough for you to hear outside sounds. Driving while not being able to hear sounds from outside the vehicle may result in an accident.
- Be careful of the volume when turning on the power. If a loud noise is emitted suddenly when you turn on the power, it may damage your hearing.
- Do not apply a strong force to the display. Doing so may result in a malfunction.
- Do not touch the hot parts of the unit. The hot parts may burn you.
- Do not use while there is an abnormality such as sound breakup or distortion. Doing so may result in a fire.
- Using the unit during extremely high or low temperature may result in mistaken operation or a malfunction. In particular, the temperature inside the vehicle can often rise to a high level during the summer. Cool the vehicle, for example by opening a window, before using the unit.
- Be careful if metal or water enters the unit, or the unit is exposed to a strong impact, because it may result in a malfunction.
- The touch buttons on the display screen may not operate correctly if condensation forms inside them. If this happens, do not attempt to operate the switches until the condensation has disappeared.
- If juice or similar liquid is spilled on the display, wipe off immediately. Failure to do so may result in product malfunction.

- The screen is easily marked by fingerprints and tends to attract dust, and should therefore be cleaned occasionally. When cleaning, turn off the power, and wipe lightly with a soft, dry cloth. To remove dirt, soak a soft cloth in neutral detergent and squeeze well before wiping. Do not use a wet floor-cloth, organic solvents (benzene, ethanol, thinner, etc.), acids, or alkalis. Using such agents will result in screen deterioration. Furthermore, do not hit the screen or rub it with hard objects.

NOTE

- SUBARU CORPORATION is not responsible for any damages to the purchaser or third parties that occur from using the map data.
- We do not provide any replacements or refunds for any mistakes there may be in the map data displays or contents, such as misspelling, omissions or misaligned positions.
- SUBARU CORPORATION makes no guarantee that the functions included in the map data will be appropriate for the specific objectives of the purchaser.
- Functions that cannot be operated while driving have their colors toned down when the vehicle is being driven, and their operation is disabled. Touching a disabled switch may result in the display of an operation prohibited message on the screen.
- When using the unit for the first time after purchase, or after the battery was removed for a long time, the current position may not be displayed correctly. Wait a short time until the GPS positioning corrects the displayed position.
- This device is precision-engineered equipment and the recorded data can be lost as a result of static electricity, electrical noise, vibration, or other influences. To protect the device against data loss, we recommend keeping a separate record of the data that you record after purchase.

NOTE

- The screen may be adversely affected or disturbed by noise if electrical equipment that generates powerful electrical noise is used near the system. In such cases, keep the electrical equipment at a distance, or refrain from use.
- The display may appear brighter when the temperature is low, or immediately after starting the engine, however, this is a characteristic of the LED elements, and does not indicate a fault. The display will return to its original brightness when the vehicle cabin has warmed up.
- When you look at the screen through polarized material such as polarized sunglasses, the screen may be dark and hard to see. If so, look at the screen from different angles, adjust the screen settings on the general settings screen or take off your sunglasses.
- It may be difficult to view the screen if the display is exposed to sunlight from an awkward angle.
- The LCD screen may not function normally if covered with a protective film. Do not affix a protective film.
- The touch panel may function incorrectly or fail to respond if operated with objects other than fingers (nails, operation when wearing gloves, pens, etc.)
- If the system functions unexpectedly such as an area other than the one touched being selected, or failure to respond when touched, there is a possibility that another finger or part of the hand is in contact with display.
- Scratches on the system panel surface are easily noticeable, and it should therefore be handled with care.
- If a device that uses wireless communication is installed in the vehicle, functions using a Bluetooth device, the radio broadcast receiver, navigation system, etc. may not operate properly.

WHEN TRANSFERRING OWNERSHIP OF THE VEHICLE

CAUTION:

When transferring ownership of your vehicle, delete the personal information registered in the vehicle by performing a Factory Data Reset. For details about the Factory Data Reset, refer to the "GENERAL SETTINGS SCREEN" section. (→P.92)

Note that certain personal information inputted in the system and the phone number of any paired device will remain in vehicle data logs even after the Factory Data Reset. These data logs are strictly for quality assurance purposes and not viewable by any subsequent purchaser. To have those logs deleted permanently from the vehicle, please contact your SUBARU dealer.

SAFETY INSTRUCTION (11.6-inch display system/Dual 7.0-inch display system only)



To use this system in the safest possible manner, follow all the safety tips shown below.

Do not use any feature of this system to the extent it becomes a distraction and prevents safe driving. The first priority while driving should always be the safe operation of the vehicle. While driving, be sure to observe all traffic regulations.

Prior to the actual use of this system, learn how to use it and become thoroughly familiar with it. Read the entire manual to make sure you understand the system. Do not allow other people to use this system until they have read and understood the instructions in this manual.

For your safety, some functions may become inoperable when driving. Unavailable screen buttons are dimmed.

⚠ WARNING

- For safety, the driver should not operate the system while he/she is driving. Insufficient attention to the road and traffic may cause an accident.

SAFETY INSTRUCTION (11.6-inch display with Navi system only)



To use this system in the safest possible manner, follow all the safety tips shown below.

This system is intended to assist in reaching the destination and, if used properly, can do so. The driver is solely responsible for the safe operation of your vehicle and the safety of your passengers.

Do not use any feature of this system to the extent it becomes a distraction and prevents safe driving. The first priority while driving should always be the safe operation of the vehicle. While driving, be sure to observe all traffic regulations.

Prior to the actual use of this system, learn how to use it and become thoroughly familiar with it. Read the entire manual to make sure you understand the system. Do not allow other people to use this system until they have read and understood the instructions in this manual.

For your safety, some functions may become inoperable when driving. Unavailable screen buttons are dimmed. Only when the vehicle is not moving, can the destination and route selection be done.

⚠ WARNING

- For safety, the driver should not operate the system while he/she is driving. Insufficient attention to the road and traffic may cause an accident.
- While driving, be sure to obey the traffic regulations and maintain awareness of the road conditions. If a traffic sign on the road has been changed, route guidance may not have the updated information such as the direction of a one way street.

While driving, listen to the voice instructions as much as possible and glance at the screen briefly and only when it is safe. However, do not totally rely on voice guidance. Use it just for reference. If the system cannot determine the current position correctly, there is a possibility of incorrect, late, or non-voice guidance.

The data in the system may occasionally be incomplete. Road conditions, including driving restrictions (no left turns, street closures, etc.) frequently change. Therefore, before following any instructions from the system, look to see whether the instruction can be done safely and legally.

This system cannot warn about such things as the safety of an area, condition of streets, and availability of emergency services. If unsure about the safety of an area, do not drive into it. Under no circumstances is this system a substitute for the driver's personal judgement.

Use this system only in locations where it is legal to do so. Some states/provinces may have laws prohibiting the use of video and navigation screens next to the driver.

HOW TO READ THIS MANUAL

Bluetooth® SETTINGS

REGISTERING A Bluetooth PHONE/DEVICE

Up to 7 (11.6-inch display system/11.6-inch display with Navi system) or 5 (Dual 7.0-inch display system) Bluetooth phones/devices can be registered.

Bluetooth compatible phones (HFP) and devices (AVP) can be registered simultaneously.

This operation cannot be performed while driving.



▶ 11.6-inch display system/11.6-inch display with Navi system



1. Select .
2. Select **Add** (Add).

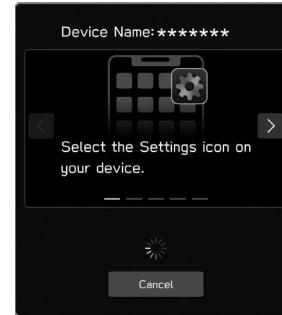

- If a message appears, follow the guidance on the screen.

3. Follow instructions displayed to operate the Bluetooth phone/device.



-  / : Select to scroll the instructions.
- **Cancel** (Cancel): Select to cancel the registration.
- For details on operating the Bluetooth phone/device, see the manual that comes with it.

No.	Name	Description
	Operational Outlines	An outline of the operation is explained.
	Main Operations	The steps of an operation are explained.
	Supplemental information	Describes supplemental information relating to main operation.

- When a panel button should be selected, button names are shown as .
- When a touch button on the screen should be selected, button names are shown as .

MEMO

1 Quick Guide



System Types	14
Dual 7.0-inch Display System	
Function Overview	15
Main Product Features	16
Basic Function	19
Button Overview	19
Home Screen	20
Car Information/Climate Control Screen	22
Pairing The System	
With A Bluetooth Phone/Device	23
Adding A Bluetooth Phone/Device	24
Create A Driver Profile	25
Phone Screen	26
Apps Screen	29

Radio Screen	32
Useful SiriusXM® Radio Functions	33
Media Screen	34
Connecting A USB Memory Device/ Portable Device	35
Settings Screen	36
Steering Wheel Controls	38
Steering Wheel Controls	38
11.6-inch Display System/ 11.6-inch Display With Navi System	
Function Overview	39
Main Product Features	40
Basic Function	43
Overview	43

Home Screen	44
Pairing The System	
With A Bluetooth Phone/Device	46
Managing A Bluetooth Phone/Device	47
Create A Driver Profile	48
Car Information Screen	49
Phone Screen	50
Map Screen	54
Radio Screen	56
Useful SiriusXM® Radio Functions	57
Media Screen	58
Connecting A USB Memory Device/ Portable Device	59
Apps Screen	60
Settings Screen	63
Steering Wheel Controls	65
Steering Wheel Controls	65

SYSTEM TYPES

This Owner's Manual describes the following three types of system.

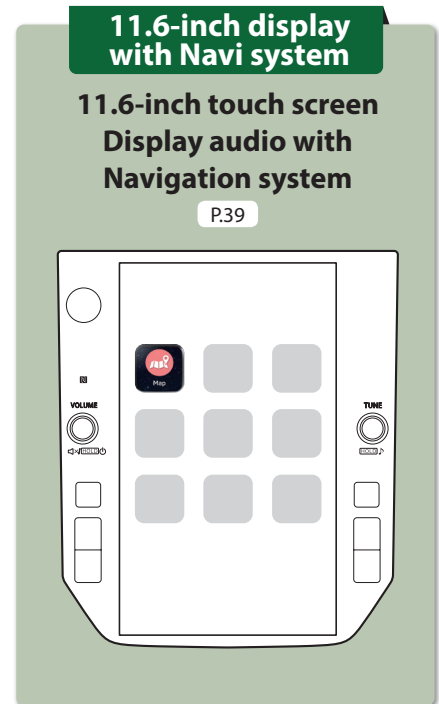
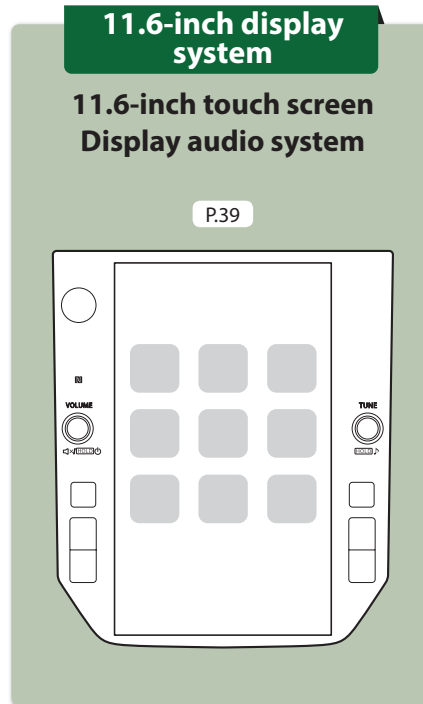
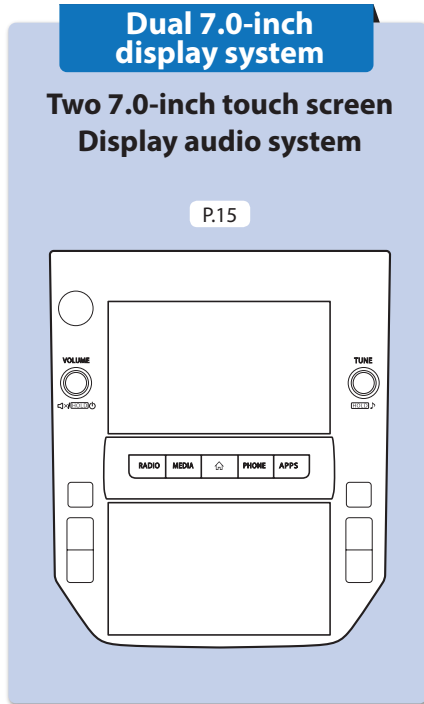

FUNCTION OVERVIEW

FUNCTION OVERVIEW

Features: - **Two 7.0-inch touch screens**

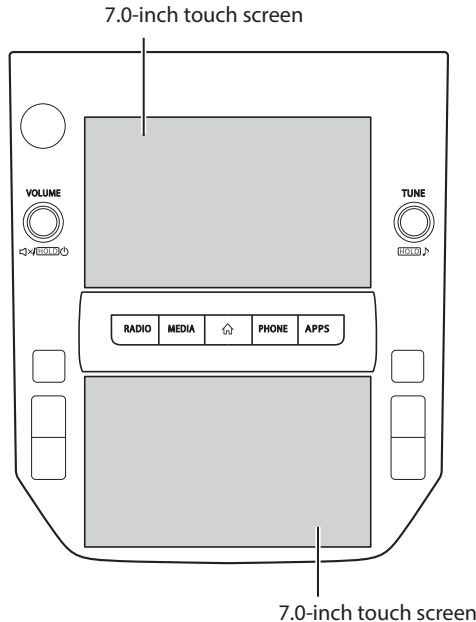

» MAIN FUNCTIONS

Pairing (Bluetooth 4.2)	P.23
Apps	P.29
Apple CarPlay	P.133
Android Auto	P.137
AM/FM radio	P.32
HD Radio receiver	P.159
SiriusXM® radio	P.33
Media operation	USB: P.168 iPod/iPhone: P.170 Bluetooth audio: P.173 AUX: P.177
Phone	P.26
Voice recognition system	P.226
Valet mode	P.18
Steering wheel controls	P.38
Rear view camera	Refer to the vehicle Owner's Manual.
Car settings/informations	
Climate controls	

MAIN PRODUCT FEATURES

Adoption of intuitive and easy-to-use smartphone-like graphical user interface



Meter cluster linked display

Two 7.0-inch touch screen displays have been adopted. Information can be displayed seamlessly between these displays and the display in the meter cluster.

Function description display function

Function descriptions or operation hints can be displayed when an **i** icon displayed next to the name of a function.

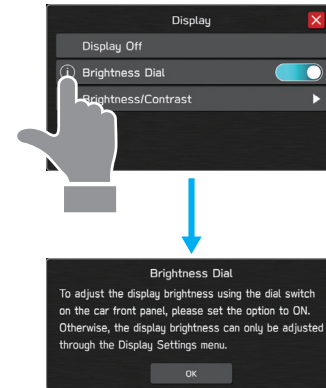

Customized home screen layout P.76

Frequently used functions and operations can be added to the home screen.

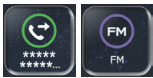
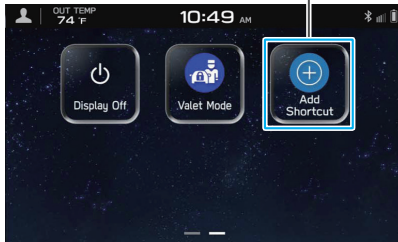

Example: For calling specific phone numbers, listening to FM radio stations, etc.

The position of screen buttons can be changed by selecting and holding it, then dragging it to the desired position.

Apple CarPlay/Android Auto

Support for Apple CarPlay and Android Auto allows access to functions such as maps, phone calls, and music.

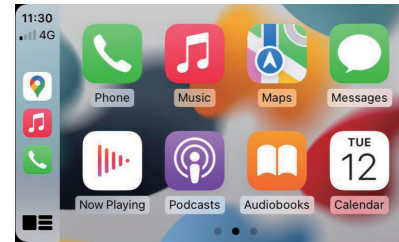

P.133

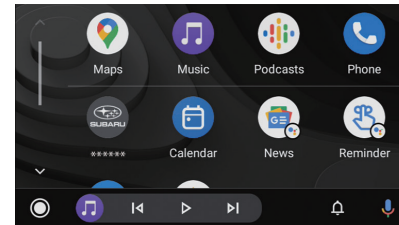

P.137

System and Bluetooth phone/device pairing P.23

Functions such as hands-free and applications can be used by connecting the system with Bluetooth phones/devices wirelessly.



Valet mode

Valet mode restricts operations of the system when valet parking is used, to prevent unwanted access to personal information stored in the system.

To enable/disable valet mode, enter a password preset by the user.

Refer to the vehicle Owner's Manual.

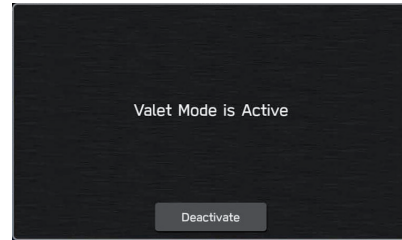

BASIC FUNCTION

BUTTON OVERVIEW

TOUCH SCREEN

Operations are performed by touching the touch screen directly with your finger. P.70

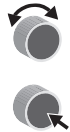

Turn the knob to adjust the volume.

Press the knob to turn the volume mute on/off.



Press and hold the knob to turn the audio system on, press and hold the knob again or press .

Press and hold the knob for 10 seconds or longer to reset the system if the touch screens become unresponsive during operation or if any other system error occurs.

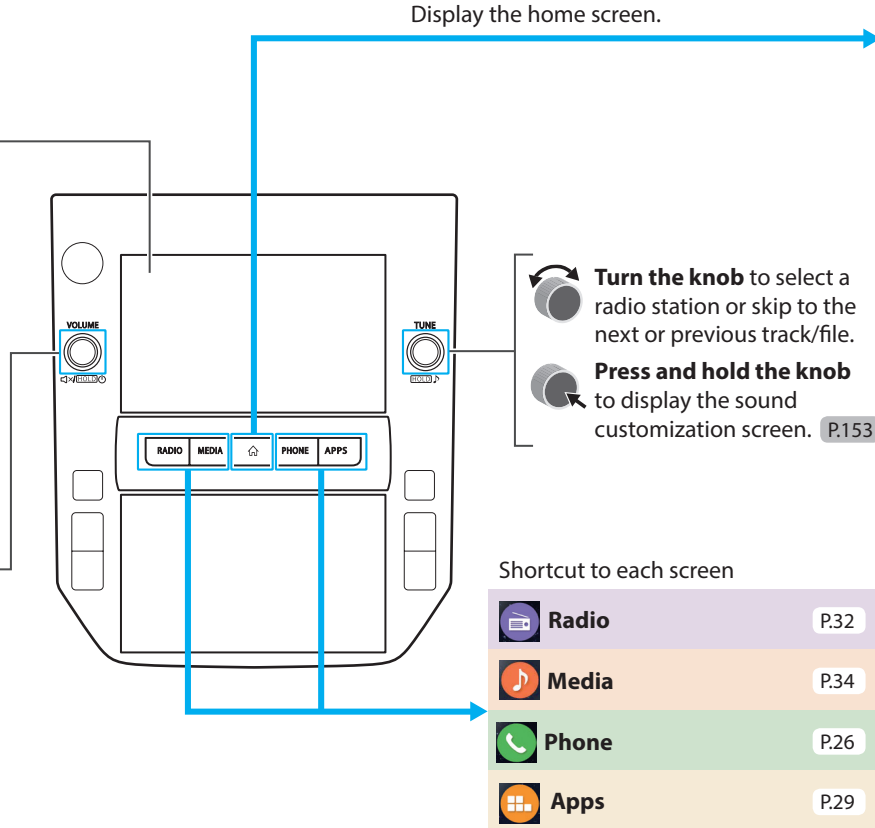

HOME SCREEN

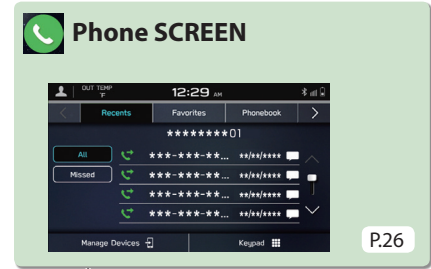
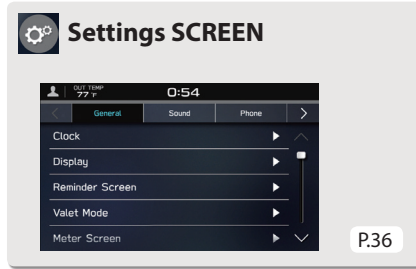
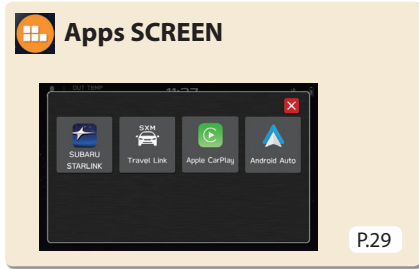

Set a driver profile
P.25



Status display P.75

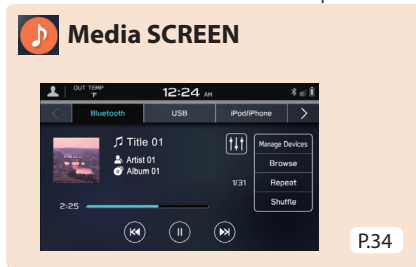

While Apple CarPlay or Android Auto is being used, an Apple CarPlay or Android Auto icon will be displayed on the home screen. P.133,137

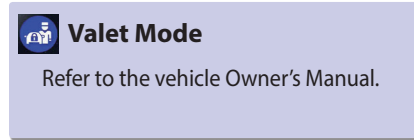

Turn the display off.
To turn the display on, press and hold
the "VOLUME" knob or press .

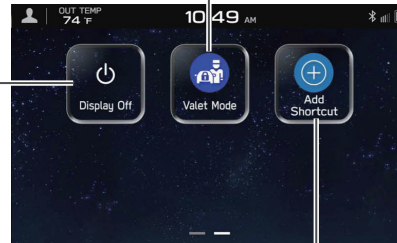

Add Shortcut



Frequently used functions and operations can be added to the home screen. **P.76**

Button positions can be changed freely. **P.77**

CAR INFORMATION/CLIMATE CONTROL SCREEN

The settings of driving related functions etc. can be changed.
Refer to the vehicle Owner's Manual.



Displays the operating status of climate control.
Refer to the vehicle Owner's Manual.

Turn the Auto Start Stop system on/off.
Refer to the vehicle Owner's Manual.

The settings of various vehicle related functions can be changed.
For settings related to EyeSight, refer to the Owner's Manual supplement for the EyeSight system. For all other functions and settings, refer to the vehicle Owner's Manual.



Turn the Auto Vehicle Hold system on/off.
Refer to the vehicle Owner's Manual.

Turn the Vehicle Dynamics Control system on/off.
Refer to the vehicle Owner's Manual.

Setup and display vehicle part replacement intervals.
Refer to the vehicle Owner's Manual.

Displays the operating status of vehicle functions, vehicle status, and vehicle inclination.
Refer to the vehicle Owner's Manual.

PAIRING THE SYSTEM WITH A Bluetooth PHONE/DEVICE

» Display the phone screen.

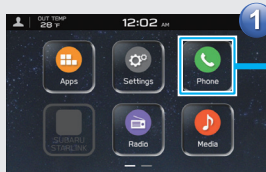

Prepare the Bluetooth phone/ device to be paired.



» Operate the Bluetooth phone/device.

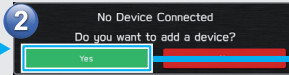

Follow instructions displayed to operate the Bluetooth phone/device.

» Register the Bluetooth phone/device.

If a confirmation message appears asking whether to transfer the phone's contact data to the system, select the appropriate button.

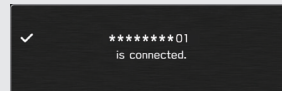

If unable to pair, check whether your Bluetooth phone/device is compatible with the system.

ADDING A Bluetooth PHONE/DEVICE

Adding from the phone screen

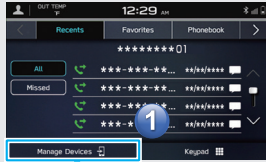

Adding from the Bluetooth audio screen



Adding from the settings screen

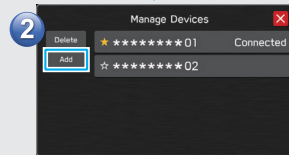
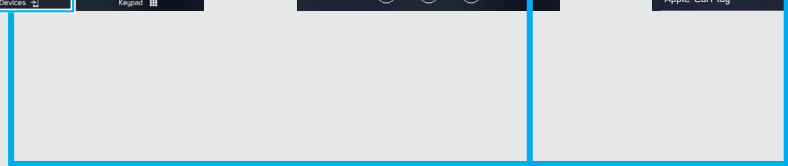

CREATE A DRIVER PROFILE

» Add a new profile.

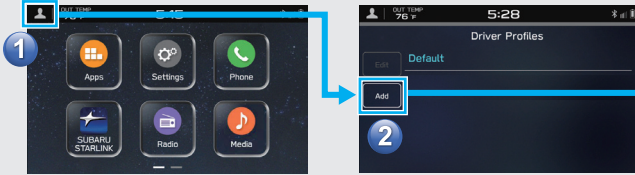

» Select a language.

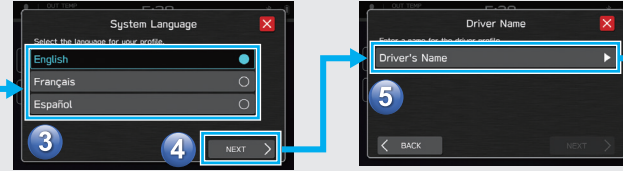

» Registering a Bluetooth phone

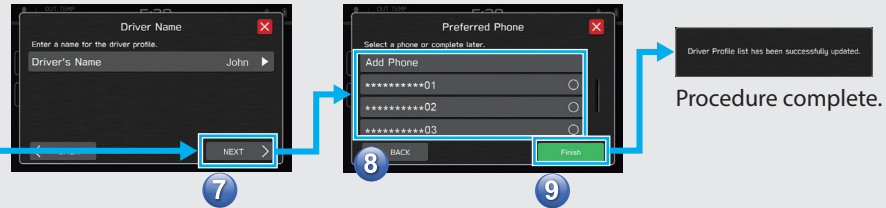

Phone SCREEN

Call or send a text message* to a recent contact P.110,120

Call or send a text message* to a registered favorite P.111,120

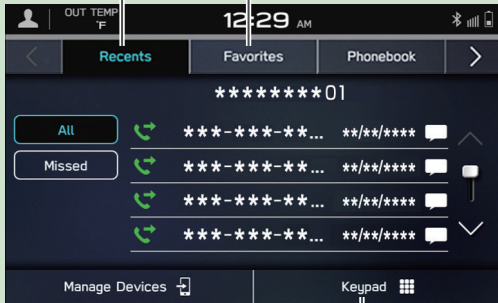

Call or send a text message* to a contact in the phonebook on the Bluetooth connected phone P.112,120

Check or reply* to messages/place calls from received message list P.119,120,121

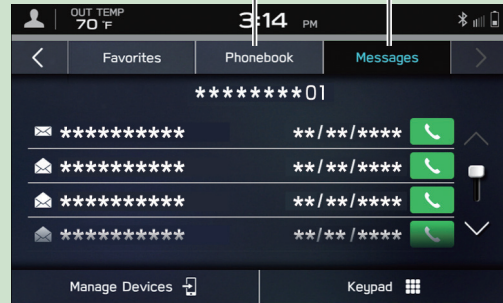

Directly input a number to place a call P.112

*: If available (for iOS only reception possible)

- Operation Flow: Receiving Calls and Using the Bluetooth Phone -

» Incoming call screen is displayed.

» In-call screen is displayed.

In-call screen display and operation may differ, or may not be possible depending on the Bluetooth phone used.

- Operation Flow: Placing Calls from the Phonebook -

» Select call recipient from phonebook.

The notification setting on the Bluetooth phone may need to be activated in order to download the phonebook. If the phonebook download setting is off and a phonebook has not been downloaded, a message will be displayed and the phonebook of the connected Bluetooth phone can be downloaded. P.91

» Select number for making call.

Place call

- Operation Flow: Receiving a Message* -

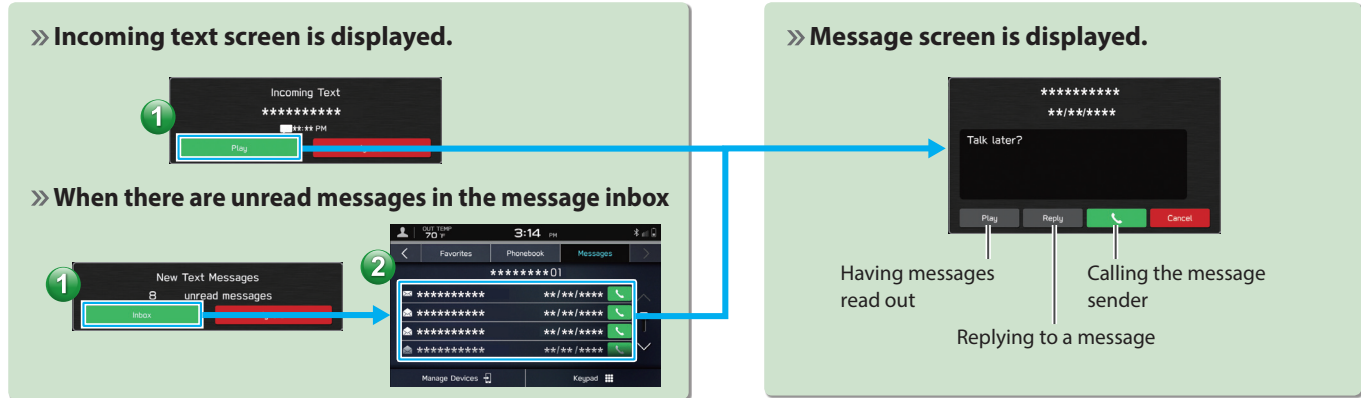

- Operation Flow: Sending a Message* from the Phonebook -

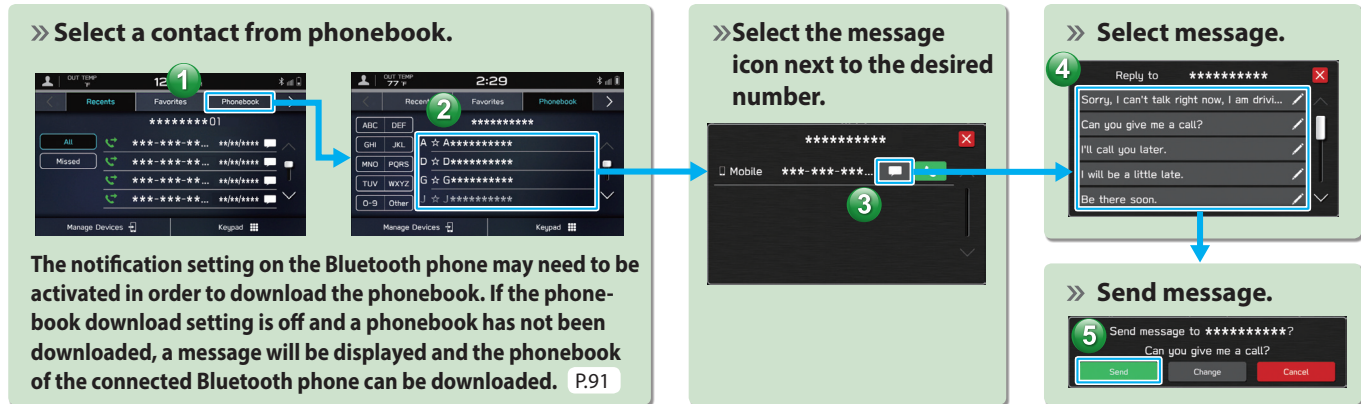

Apps SCREEN

Usable
applications

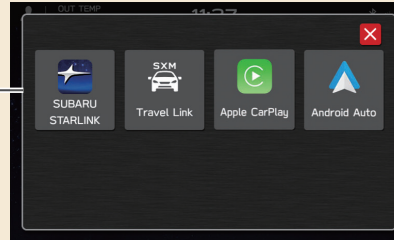

SUBARU STARLINK



The SUBARU STARLINK app allows users to connect a smartphone to the system, using either Bluetooth or undamaged genuine USB cable (recommended), and access to various music, navigation, vehicle guide applications, and much more.

Download the SUBARU STARLINK app from the Apple App Store or Google Play Store.

To use the SUBARU STARLINK application, connect your iPhone to the USB port or via Bluetooth, or connect your Android device via Bluetooth. **P.127**



Apple CarPlay

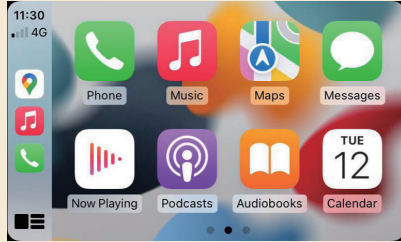

Apple CarPlay can be used to view Apple Maps, play music, and place calls by connecting an Apple CarPlay device to the system. Supported applications can also be run.

To use the Apple CarPlay application, connect an Apple CarPlay device to the USB port with undamaged genuine USB cable. P.133

For details on the services or the operations, check the Apple CarPlay site (<https://www.apple.com/ios/carplay/>).



Android Auto

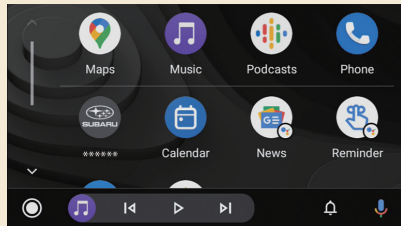

Android Auto can be used to view Google Maps, play music, and place calls by connecting an Android Auto device to the system, using USB cable and Bluetooth. Supported applications can also be run.

To use the Android Auto application, connect your Android Auto device to the USB port with undamaged genuine USB cable. P.137

For details on the services or the operations, check the Android Auto site (<https://www.android.com/auto/>) and (<https://support.google.com/androidauto/>).



SiriusXM Travel Link

SiriusXM Travel Link is a service provided by SiriusXM® Radio, and can be used to view information on fuel prices, sports, stocks, weather, weather alerts and parking. P.141

To receive the data service information in the vehicle, a subscription to the SiriusXM® Radio Service is necessary following a free trial. P.165

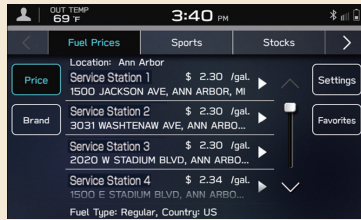

Fuel prices



Sports



Stocks



Weather

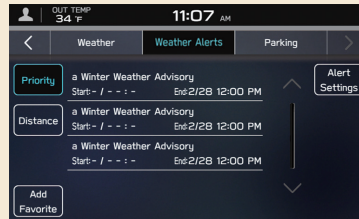

Weather alerts

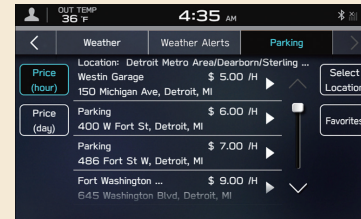

Parking

Radio SCREEN

Change radio mode

Preset stations/channels

Select to change multicast channels available (FM).

Select to scan for receivable stations/channels.

Select to display a list of receivable stations (AM/FM).

Select to turn HD Radio mode on/off (AM/FM).

Select to search for stations/channels by entering frequency/channel number.

PAUSE AND PLAYBACK LIVE RADIO

Skip backward

Pause/play

Skip forward

Depending on the radio broadcast, the broadcast can be temporarily saved and played back later. P.161

- Operation Flow: Presetting a Radio Station -

» Select the radio band and the radio station.



A valid subscription to SiriusXM® Radio is required to receive satellite radio service.

» Register the radio station.



Select and hold one of the preset buttons.

Mix preset function

Multiple stations can be registered as presets. (AM, FM or SiriusXM® Radio)
P.158,167

USEFUL SiriusXM® Radio FUNCTIONS

- For you:
Displays content suggestions based on the registered descriptions of driver profile and history of SiriusXM contents access. P.163
- Categories:
Displays a channel list by category. P.163
- Related:
Display a list of contents related to the current content you are listening to. P.163

Media SCREEN

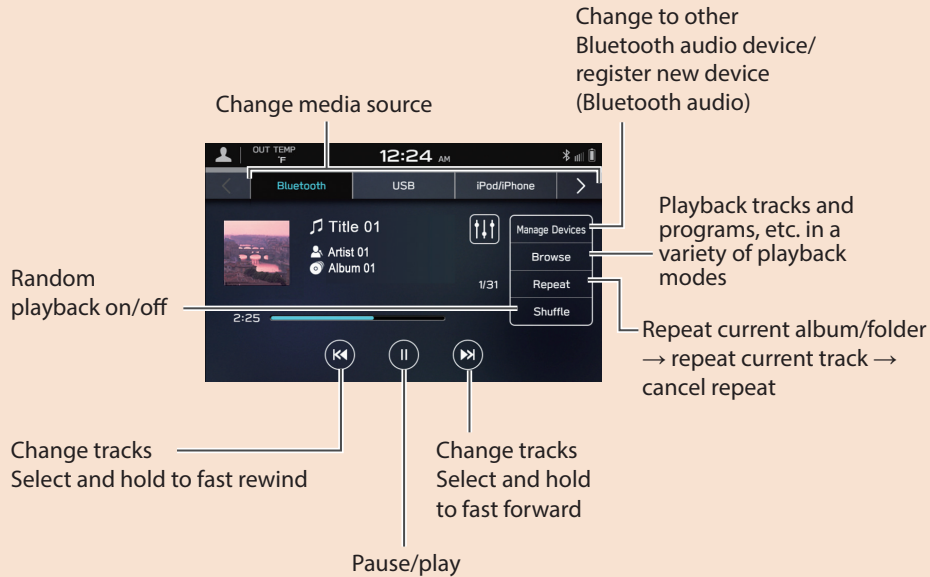

SUPPORTED MEDIA

USB/iPod/iPhone P.188

Bluetooth audio P.81

CONNECTING A USB MEMORY DEVICE/PORTABLE DEVICE

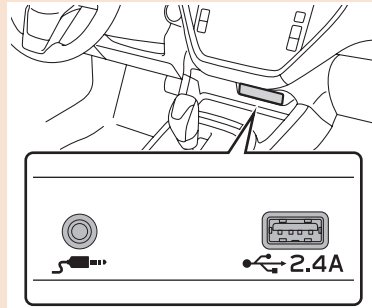

- Operation Flow: Using Playback Modes -

» Display the playback mode list.

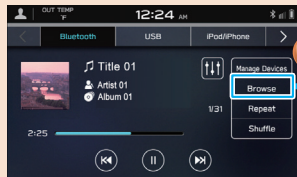

» Select the playback mode.

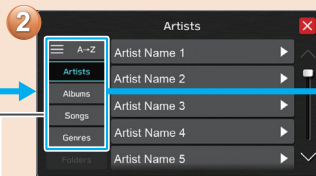

» Play a track.

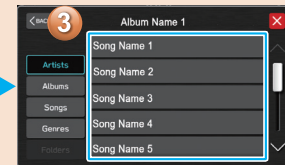

Depending on the audio source, several items from these categories are displayed in a list.

Settings SCREEN

General P.92



SCROLL

Sound P.98

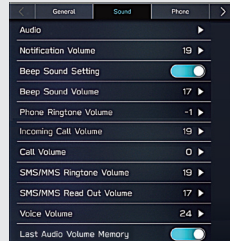

SCROLL

Phone P.83



SCROLL

Radio P.100

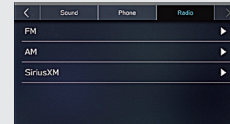

- Operation Flow: Setting the Clock Manually -

Under normal conditions, when a Bluetooth phone is connected to the system, the clock will be adjusted automatically. If the clock is not adjusted automatically or a Bluetooth phone is not connected, it is necessary to adjust the clock manually.

» Display the clock settings screen.

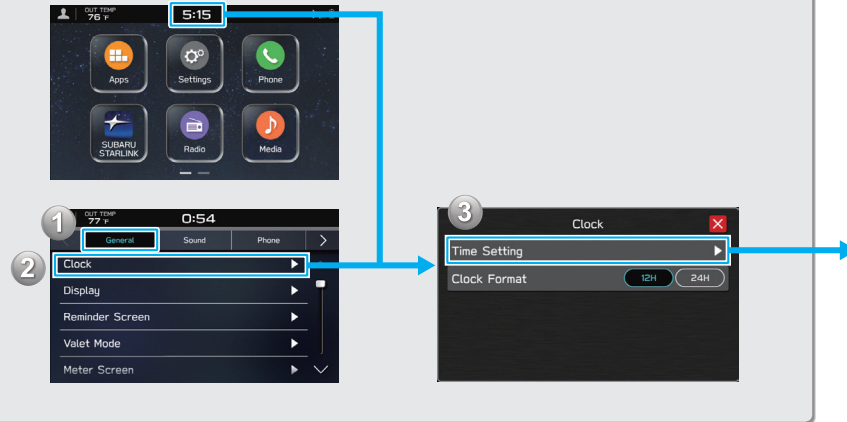

» Select the manual mode.



» Adjust the clock.

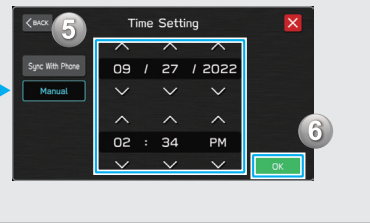

STEERING WHEEL CONTROLS

STEERING WHEEL CONTROLS

Some parts of the audio system can be controlled using the steering wheel controls.

P.184

RADIO

Press: Preset station/channel up/down

Press and hold: Scan and stop at the first received station when the switch is released

MEDIA

Press: Change a track/file

Press and hold: Fast forward/rewind

Press: End a call (during a call) or turn mute on/off (while in audio system mode)

P.108,184

Press: Receive a call

P.108

Press: Volume up/down

Press and hold: Volume up/down continuously

Press: Turn on the audio system or change the audio source mode

Press and hold: Turn off the audio system

Press: Start the voice recognition system

P.226

Press and hold: Start the Apple CarPlay/Android Auto voice recognition function

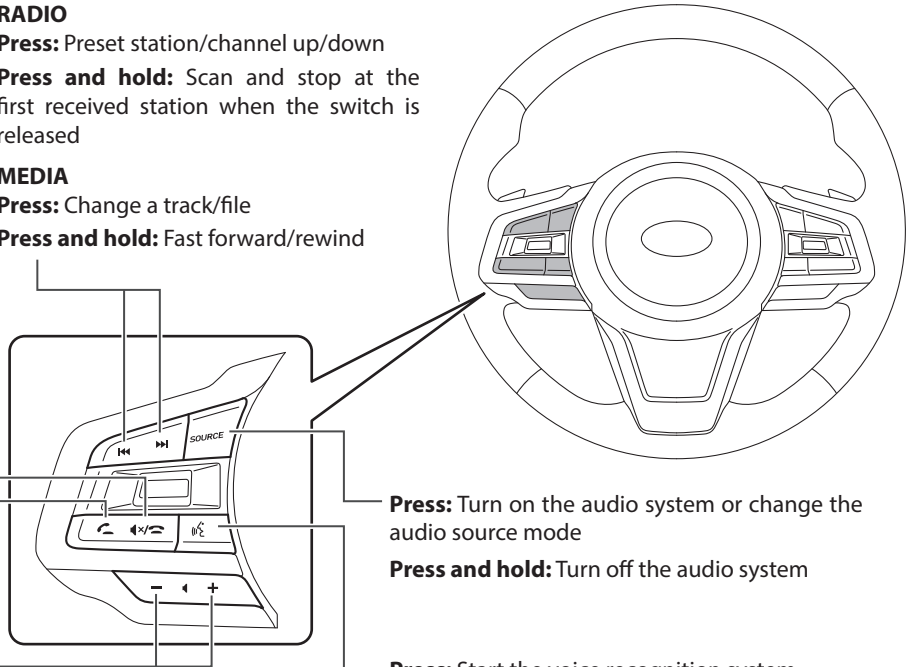

FUNCTION OVERVIEW

FUNCTION OVERVIEW

Features: - **11.6-inch touch screen**
 - **Map (Map) button***1*2

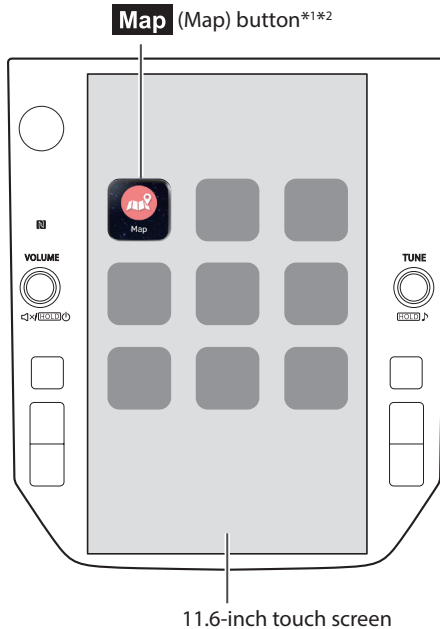

» MAIN FUNCTIONS

Pairing (Bluetooth 5.0)	P.46
Navigation system*1	P.54
Apps	P.60
Apple CarPlay	P.133
Android Auto	P.137
AM/FM radio	P.56
HD Radio receiver	P.159
SiriusXM® radio	P.57
Media operation	USB: P.168 iPod/iPhone: P.170 Bluetooth audio: P.173 AUX: P.177
Phone	P.50
Voice recognition system	P.226
NFC	P.46
Valet mode	P.42
Steering wheel controls	P.65
Rear view camera	Refer to the vehicle Owner's Manual.
Car settings/informations	
Climate controls	

*1: If equipped

*2: Displayed position may differ

MAIN PRODUCT FEATURES

Adoption of intuitive and easy-to-use smartphone-like graphical user interface



Meter cluster linked display

A large 11.6-inch touch screen display has been adopted. Information can be displayed seamlessly between this display and the display in the meter cluster.

Function description display function

Function descriptions or operation hints can be displayed when an  icon displayed next to the name of a function.

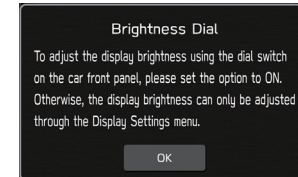

Expandable map screen*

The map screen can be expanded to fill more of the display.



Rough destination search function* P.201

Start a search with a variety of words such as addresses, facility names, intersection names, latitude/longitude, or "what3words".



Displays search prediction

- Search results are predicted and candidates displayed even if only partial words are known
- Searches can even be performed with multiple keywords.

*: If equipped

Customized home screen layout P.76

Frequently used functions and operations can be added to the home screen.

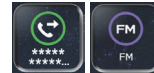
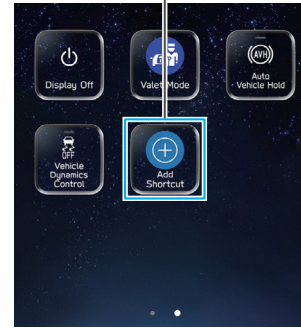

Example: For calling specific phone numbers, listening to FM radio stations, etc.

The position of screen buttons can be changed by selecting and holding it, then dragging it to the desired position.

System and Bluetooth phone/device pairing P.46

Functions such as hands-free and applications can be used by connecting the system with Bluetooth phones/devices wirelessly.



Apple CarPlay/Android Auto

Apple CarPlay/Android Auto can be used wirelessly.



P.133

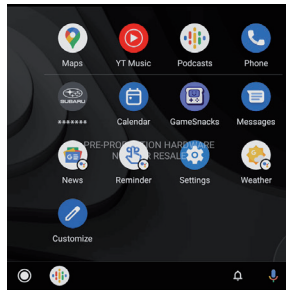

P.137

Valet mode

Valet mode restricts operations of the system when valet parking is used, to prevent unwanted access to personal information stored in the system.

To enable/disable valet mode, enter a password preset by the user.

Refer to the vehicle Owner's Manual.

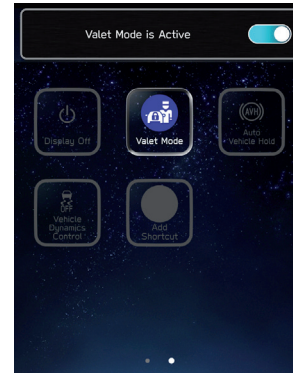

BASIC FUNCTION

OVERVIEW

TOUCH SCREEN

Operations are performed by touching the touch screen directly with your finger. P.70

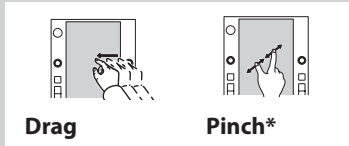

- Turn the knob** to adjust the volume.
- Press the knob** to turn the volume mute on/off.
- Press and hold the knob** to turn the audio system off. To turn the audio system on, press and hold the knob again or touch the screen to display and select it.
- Press and hold the knob** for 10 seconds or longer to reset the system if the touch screen becomes unresponsive during operation or if any other system error occurs.

Status display area P.75

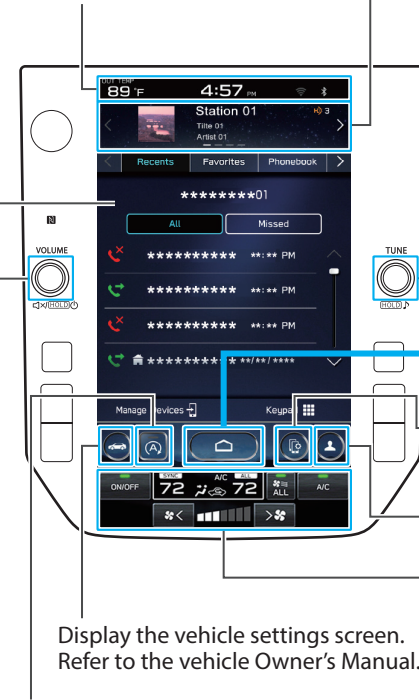

Information display area
Touch to display the operation screen of the selected category. Refer to the vehicle Owner's Manual.

- Turn the knob** to select a radio station or skip to the next or previous track/file.
- Press and hold the knob** to display the sound customization screen. P.153

- Display the home screen.
- Display the manage devices screen. P.46,47
- Set a driver profile P.48
- Climate control display area
Refer to the vehicle Owner's Manual.

Turn the Auto Start Stop system on/off. Refer to the vehicle Owner's Manual.

*: If equipped

HOME SCREEN

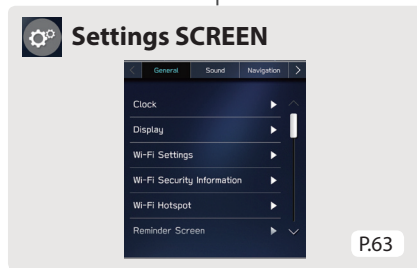
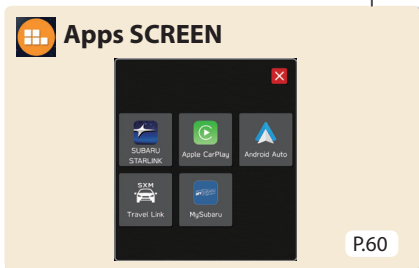
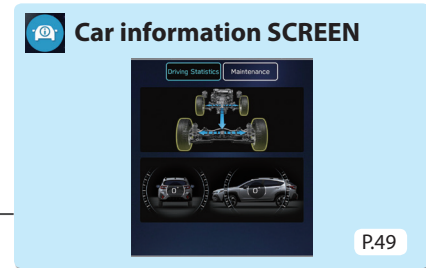
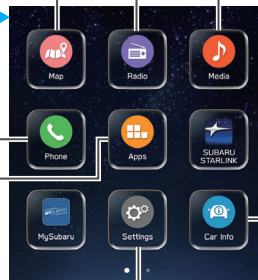
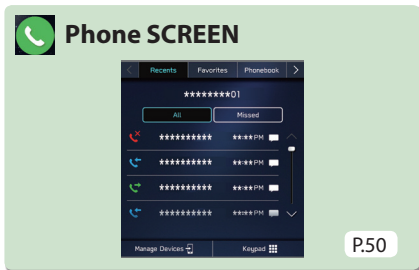
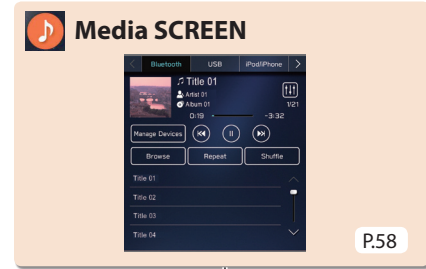
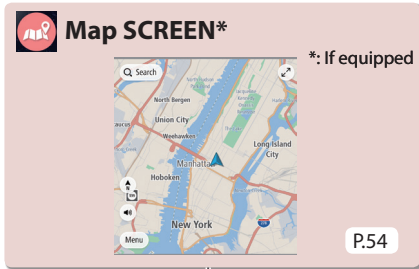

While Apple CarPlay or Android Auto is being used, an Apple CarPlay or Android Auto icon will be displayed on the home screen. P.133,137

 **Valet Mode**
Refer to the vehicle Owner's Manual.

Turn the display off.
To turn the display on, press and hold the "VOLUME" knob or touch the screen to display  and select it.



Turn the Auto Vehicle Hold system on/off.

Refer to the vehicle Owner's Manual.

Turn the Vehicle Dynamics Control system on/off.

Refer to the vehicle Owner's Manual.

 **Add Shortcut**

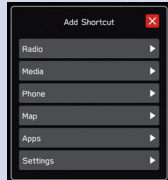



Frequently used functions and operations can be added to the home screen. P.76

Button positions can be changed freely. P.77

PAIRING THE SYSTEM WITH A Bluetooth PHONE/DEVICE

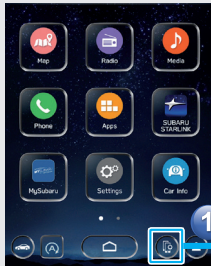
» Display the manage devices screen.



 Prepare the Bluetooth phone/device to be paired.

» Operate the Bluetooth phone/device.

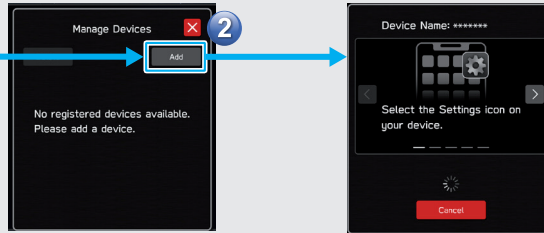

 Follow instructions displayed to operate the Bluetooth phone/device.

» Register the Bluetooth phone/device.

If a confirmation message appears asking whether to transfer the phone's contact data to the system, select the appropriate button.

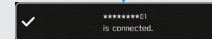

If unable to pair, check whether your Bluetooth phone/device is compatible with the system.

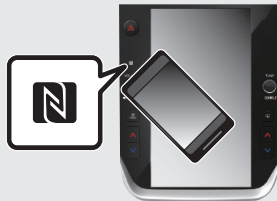

When using an NFC compatible device, it is not necessary to perform the above procedure.

Pairing can be performed by holding the device against the NFC logo of the audio system with the NFC setting on.

MANAGING A Bluetooth PHONE/DEVICE

» Display the manage devices screen.

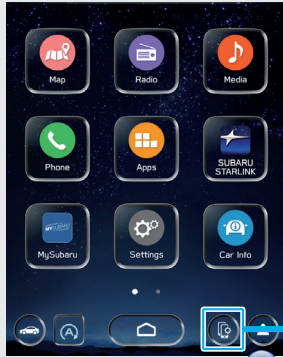

» Select a device

Delete the device Add the device

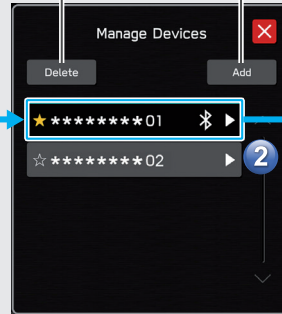

» Select to enable/disable the function.

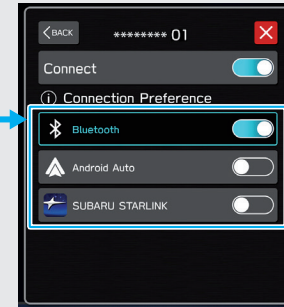



CREATE A DRIVER PROFILE

» Add a new profile.



» Select a language.

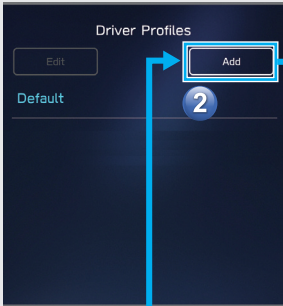

1

2

3

4

5

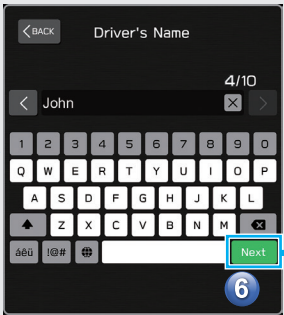

6

Enter a name.

» Registering a Bluetooth phone

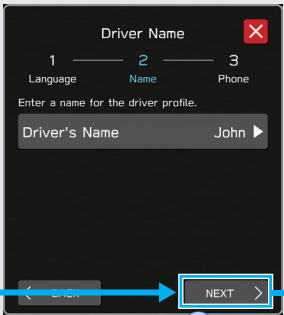

7



8

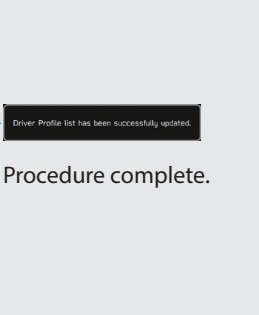

9

Finish

Driver Profile list has been successfully updated.

Procedure complete.

Car information SCREEN

Displays the operating status of vehicle functions, vehicle status, and vehicle inclination.

Refer to the vehicle Owner's Manual.



Setup and display vehicle part replacement intervals.

Refer to the vehicle Owner's Manual.

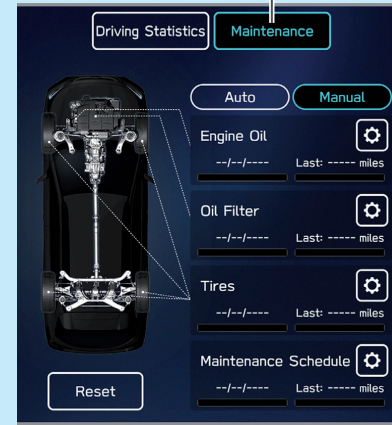

Phone SCREEN

Call or send a text message* to a recent contact P.110,120

Call or send a text message* to a registered favorite P.111,120

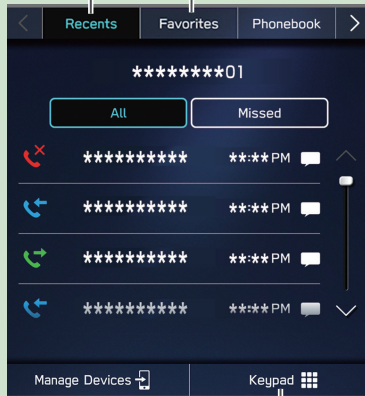

Directly input a number to place a call P.112

Call or send a text message* to a contact in the phonebook on the Bluetooth connected phone P.112,120

Check or reply* to messages/place calls from received message list P.119,120,121

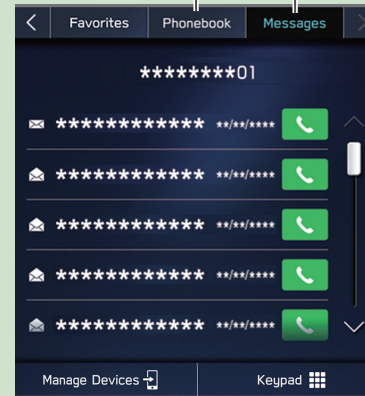

*: If available (for iOS only reception possible)

- Operation Flow: Receiving Calls and Using the Bluetooth Phone -

» Incoming call screen is displayed.

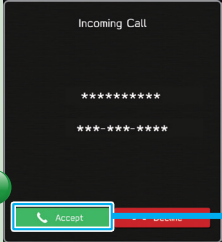

» In-call screen is displayed.

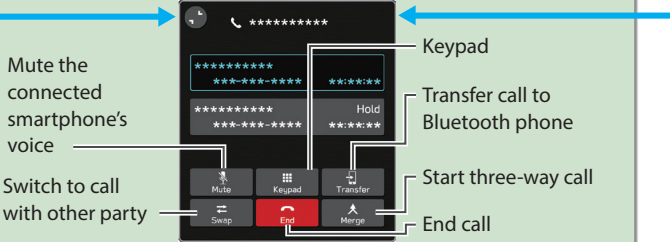

Mute the connected smartphone's voice

Switch to call with other party

In-call screen display and operation may differ, or may not be possible depending on the Bluetooth phone used.

Keypad

Transfer call to Bluetooth phone

Start three-way call

End call

- Operation Flow: Placing Calls from the Phonebook -

» Select call recipient from phonebook.

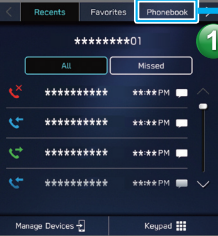

» Select number for making call.

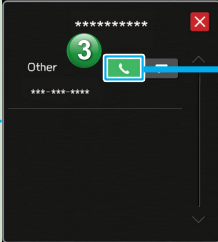

Place call

The notification setting on the Bluetooth phone may need to be activated in order to download the phonebook. If the phonebook download setting is off and a phonebook has not been downloaded, a message will be displayed and the phonebook of the connected Bluetooth phone can be downloaded. P.91

- Operation Flow: Receiving a Message* -

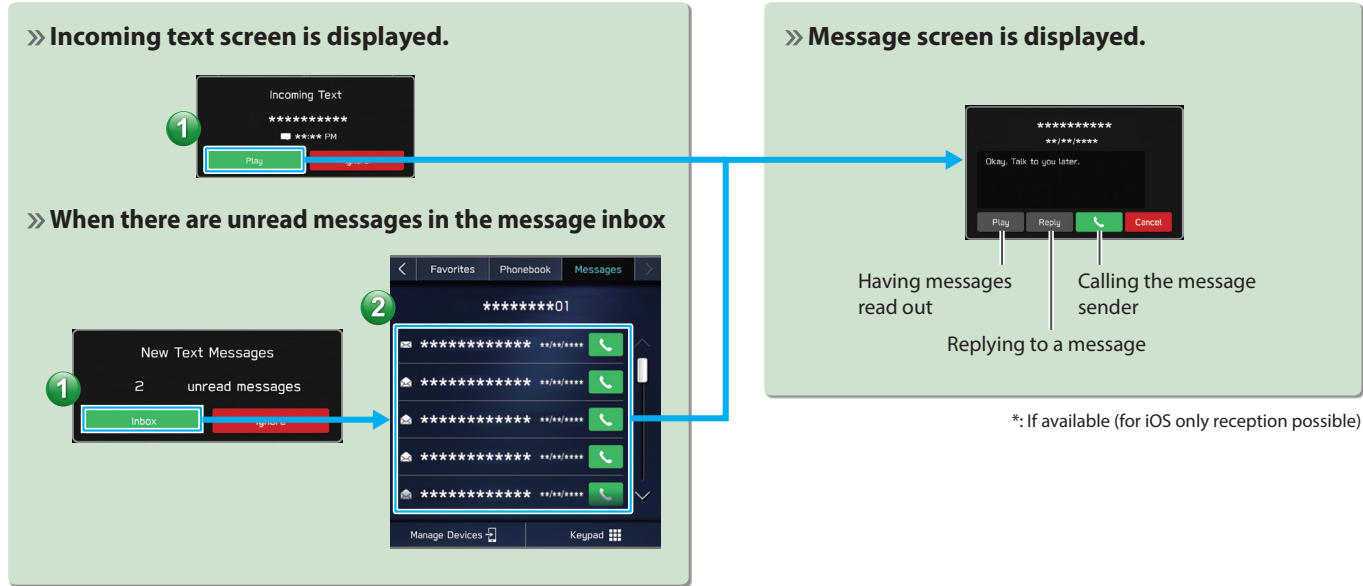

- Operation Flow: Sending a Message* from the Phonebook -

» Select a contact from phonebook.



The notification setting on the Bluetooth phone may need to be activated in order to download the phonebook. If the phonebook download setting is off and a phonebook has not been downloaded, a message will be displayed and the phonebook of the connected Bluetooth phone can be downloaded.

P.91

» Select the message icon next to the desired number.

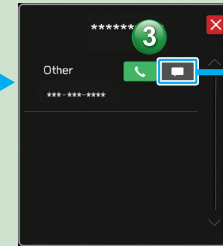

» Select message.



» Send message.

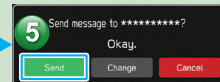

*: If available (for iOS only reception possible)

Map SCREEN*

Search by address, category, POI, etc.

Current vehicle position (facing direction of travel)

Voice guidance enable/disable

Menu button

Current street

Speed limit

Zoom in

Zoom out

Touch screen to display automatically hidden buttons. P.193

*: If equipped

The orientation of the map can be changed between 2D north-up, 3D heading-up and 2D heading-up. P.195

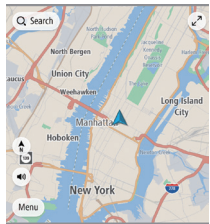

2D North-up screen

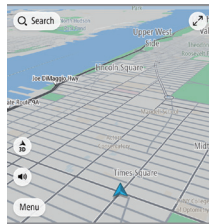

3D Heading-up screen

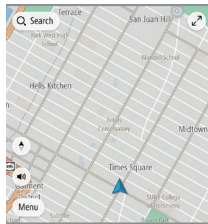

2D Heading-up screen

ROUTE GUIDANCE SCREEN

Distance to the next turn, an arrow indicating the turning direction and next street name

Estimated time of arrival

Remaining distance and/or remaining time

Current position

Guidance display after next

Guidance route

Route guidance P.208

- Operation Flow: Route Guidance -

» **Display the destination search menu.**

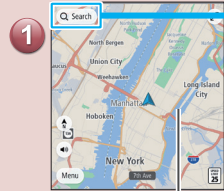

Destinations can also be set directly from the Map screen by selecting and holding at the desired position until **+** is displayed.

» **Search for your destination.**

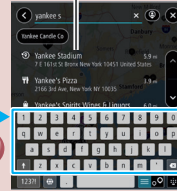

Predicted search results will automatically appear as you type.

Start a search by typing an address, category, POI, etc.

» **Select your destination.**



Destinations matching the search words are displayed in a list.

» **Start driving.**



» **Route guidance starts.**

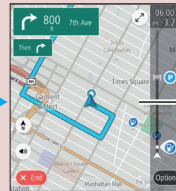

The travel route is displayed, and voice guidance starts.



JUNCTION SCREEN

RETURNING HOME

If you register an address as Home, it can be quickly set as a destination.

Register an address as Home **P.205**
 Setting Home as the destination **P.201**

The screen display automatically changes to display travel lanes at expressway junctions, etc.

P.209

Radio SCREEN

Change radio mode

Select to change multicast channels available (FM).

Select to scan for receivable stations/channels.

Select to search for stations/channels by entering frequency/channel number.

Select to display a list of receivable stations (AM/FM).

Preset stations/channels

Select to turn HD Radio mode on/off (AM/FM).

The screenshot shows a radio interface with three modes: FM, AM, and SiriusXM. The FM mode is selected, displaying 'Station 01' with a track 'Title 01' by 'Artist 01' (Adult Hits). Below the station name are buttons for '123', 'Scan', and 'Direct Tune'. A 'Replay' button is highlighted with a blue box. Below these are buttons for 'HD Radio ON', 'Replay', and 'Station List'. At the bottom, there is a grid of preset stations: 7 FM (104.3-HD2), 8 AM (1290), 9 (Hold), 10 (Hold), 11 (Hold), and 12 (Hold). A blue arrow points from the 'Replay' button in this screenshot to the 'Replay' button in the adjacent screenshot.

PAUSE AND PLAYBACK LIVE RADIO

The screenshot shows the radio interface with 'Station 0' selected. It displays 'Title 01' by 'Artist 01' (Adult Hits). Below the station name are buttons for '123', 'Scan', and 'Direct Tune'. A 'Replay' button is highlighted with a blue box. Below these are buttons for 'HD Radio ON', 'Replay', and 'Station List'. At the bottom, there is a grid of preset stations: 7 FM (104.3-HD2), 8 AM (1290), 9 (Hold), 10 (Hold), 11 (Hold), and 12 (Hold). A blue arrow points from the 'Replay' button in this screenshot to the 'Replay' button in the adjacent screenshot.

Skip backward

Pause/play

Skip forward

Depending on the radio broadcast, the broadcast can be temporarily saved and played back later. P.161

- Operation Flow: Presetting a Radio Station -

» Select the radio band and the radio station.



A valid subscription to SiriusXM® Radio is required to receive satellite radio service.

» Register the radio station.



Select and hold one of the preset buttons.

Mix preset function

Multiple stations can be registered as presets. (AM, FM or SiriusXM® Radio)
P.158,167

USEFUL SiriusXM® Radio FUNCTIONS

- For you:
Displays content suggestions based on the registered descriptions of driver profile and history of SiriusXM contents access. P.163
- Categories:
Displays a channel list by category. P.163
- Related:
Display a list of contents related to the current content you are listening to. P.163

Media SCREEN

SUPPORTED MEDIA

USB/iPod/iPhone [P.188](#)

Bluetooth audio [P.81](#)

Change to other Bluetooth audio device/
register new device
(Bluetooth audio)

Change media source

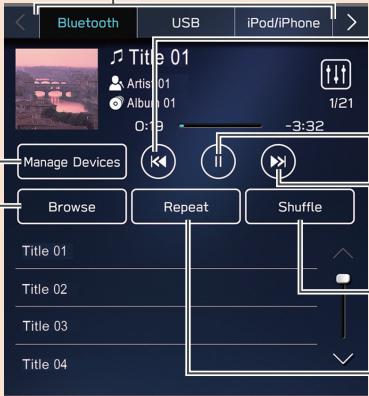

Playback tracks and programs, etc. in a variety of playback modes

Change tracks
Select and hold to fast rewind

Pause/play

Change tracks
Select and hold to fast forward

Random playback on/off

Repeat current album/folder
→ repeat current track → cancel repeat

CONNECTING A USB MEMORY DEVICE/PORTABLE DEVICE

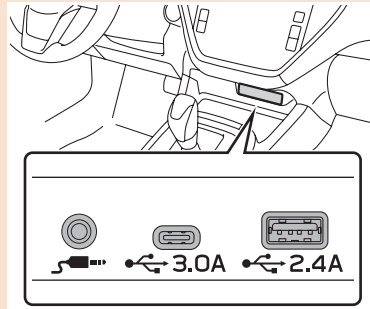

- Operation Flow: Using Playback Modes -

» Display the playback mode list.

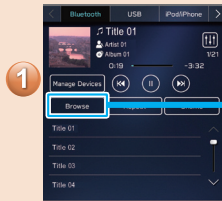

» Select the playback mode.



» Play a track.

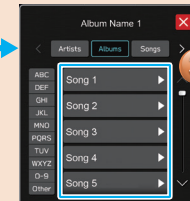

Depending on the audio source, several items from these categories are displayed in a list.

Apps SCREEN

Usable applications

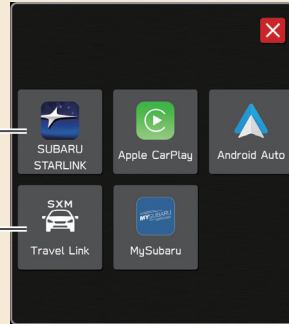

SUBARU STARLINK

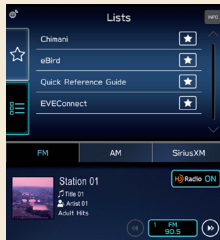

The SUBARU STARLINK app allows users to connect a smartphone to the system, using either Bluetooth or undamaged genuine USB cable (recommended), and access to various music, navigation, vehicle guide applications, and much more.

Download the SUBARU STARLINK app from the Apple App Store or Google Play Store.

To use the SUBARU STARLINK application, connect your iPhone to the USB port or via Bluetooth, or connect your Android device via Bluetooth. [P.127](#)



Apple CarPlay



Apple CarPlay can be used to view Apple Maps, play music, and place calls by connecting an Apple CarPlay device to the system. Supported applications can also be run.

To use the Apple CarPlay application, connect an Apple CarPlay device to the system wirelessly. [P.133](#)

For details on the services or the operations, check the Apple CarPlay site (<https://www.apple.com/ios/carplay/>).



Android Auto

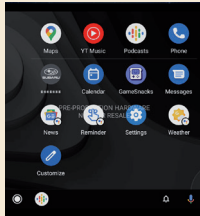

Android Auto can be used to view Google Maps, play music, and place calls by connecting an Android Auto device to the system. Supported applications can also be run.

To use the Android Auto application, connect an Android Auto device to the system wirelessly. [P.137](#)

For details on the services or the operations, check the Android Auto site (<https://www.android.com/auto/>) and (<https://support.google.com/androidauto/>).



MySubaru

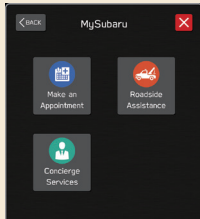

Access SUBARU STARLINK from “SUBARU STARLINK Safety and Security” for a variety of remote services.

Refer to the Owner’s Manual supplement for “SUBARU STARLINK Safety and Security” for details.



SiriusXM Travel Link

SiriusXM Travel Link is a service provided by SiriusXM® Radio, and can be used to view information on fuel prices, sports, stocks, weather, weather alerts and parking. P.141

To receive the data service information in the vehicle, a subscription to the SiriusXM® Radio Service is necessary following a free trial. P.165

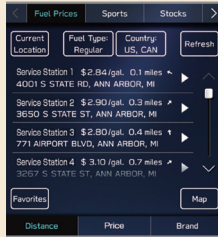

Fuel prices

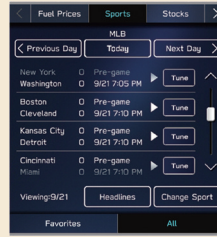

Sports

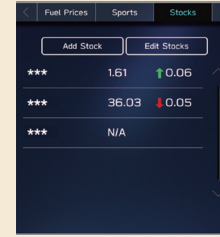

Stocks



Weather

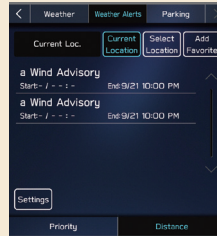

Weather alerts

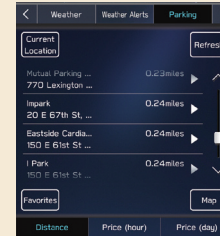

Parking

Settings SCREEN

General

P.92

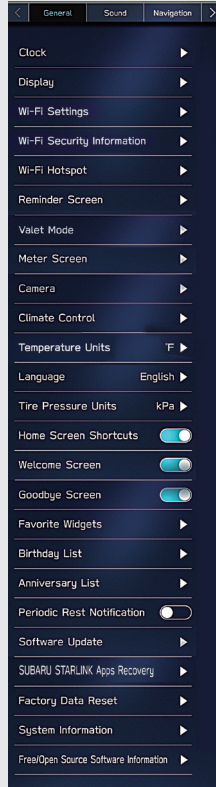

SCROLL

Sound

P.98

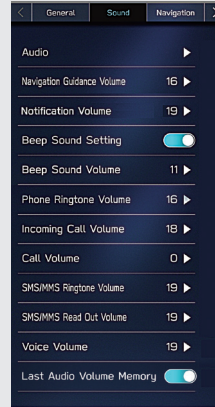

SCROLL

Phone

P.83

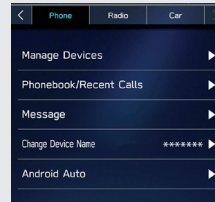

Navigation

P.215

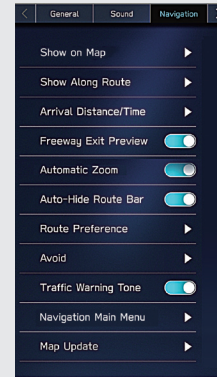

SCROLL

Radio

P.100

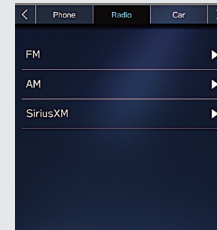

Car*

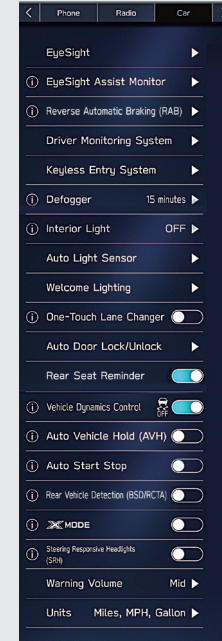

SCROLL

*: For settings related to EyeSight, refer to the Owner's Manual supplement for the EyeSight system.
For all other functions and settings, refer to the vehicle Owner's Manual.

- Operation Flow: Setting the Clock Manually -

Under normal conditions, the clock is adjusted automatically when the system receives GPS signals*1/DCM (Data Communication Module) signals*2 or when a Bluetooth phone is connected to the system*3. If the clock is not adjusted automatically, it is necessary to adjust the clock manually.

» Display the clock settings screen.

The diagram illustrates the process of navigating to the clock settings. It starts with a home screen showing various app icons. A blue box highlights the 'Settings' icon, with a circled '1' next to it. An arrow points to a 'Settings' menu where 'Clock' is highlighted with a blue box and a circled '2'. Another arrow points to a 'Clock' settings screen where 'Time Setting' is highlighted with a blue box and a circled '3'. A final arrow points to the right, indicating the next step in the process.

» Select the manual mode.

The diagram shows the 'Time Setting' screen. At the top, there are two tabs: 'AUTO' and 'Manual'. The 'Manual' tab is selected and highlighted with a blue box, with a circled '4' next to it. Below the tabs, the current time is displayed as '09 / 21 / 2022'. A blue arrow points from the 'Manual' tab to the right, indicating the next step.

» Adjust the clock.

The diagram shows the 'Time Setting' screen with the 'Manual' mode selected. A numeric keypad is visible, allowing the user to adjust the time. The current time is '09 : 24 PM'. A blue box highlights the keypad area, with a circled '5' next to it. A green 'OK' button is highlighted at the bottom with a circled '6'. A blue arrow points from the 'Manual' tab in the previous step to this screen.

*1: 11.6-inch display with Navi system
 *2: 11.6-inch display system with SUBARU STARLINK Safety and Security
 *3: 11.6-inch display system without SUBARU STARLINK Safety and Security

STEERING WHEEL CONTROLS

STEERING WHEEL CONTROLS

Some parts of the audio system can be controlled using the steering wheel controls.

P.184

RADIO

Press: Preset station/channel up/down

Press and hold: Scan and stop at the first received station when the switch is released

MEDIA

Press: Change a track/file

Press and hold: Fast forward/rewind

Press: End a call (during a call) or turn mute on/off (while in audio system mode)

P.108,184

Press: Receive a call

P.108

Press: Volume up/down

Press and hold: Volume up/down continuously

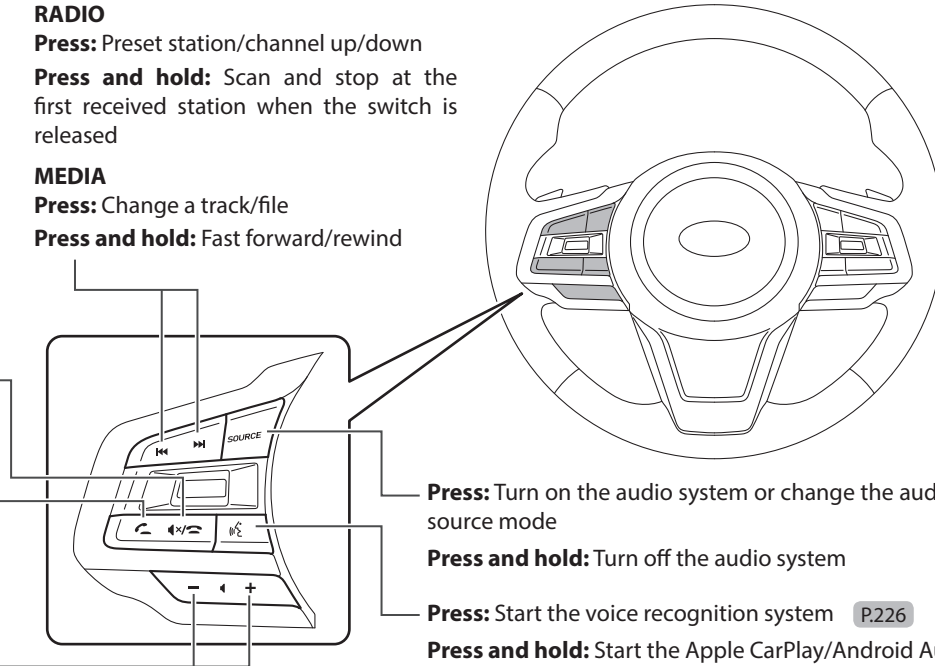

Press: Turn on the audio system or change the audio source mode

Press and hold: Turn off the audio system

Press: Start the voice recognition system P.226

Press and hold: Start the Apple CarPlay/Android Auto voice recognition function

When an Apple CarPlay/Android Auto is not used, the registration screen of a Bluetooth phone/device will be displayed. P.84

2

Basic Function



Basic Information Before Operation	68
Initial Screen	68
Initial Screen	68
Connecting And Disconnecting	
A USB Memory Device/Portable Device	69
Connecting A Device	69
Touch Screen Gestures	70
Touch Screen Operation	71

Entering Letters And Numbers/	
List Screen Operation	72
Entering Letters And Numbers	72
List Screen Operation	74
Screen Adjustment	75
Adjusting Brightness	75
Changing Between Day And Night Mode	75
Status Display	75
Home Screen Operation	76
Adding Shortcut Icons To The Home Screen	76
Moving And Deleting Shortcut Icons	77

BASIC INFORMATION BEFORE OPERATION

INITIAL SCREEN

INITIAL SCREEN

⚠ WARNING

- When the vehicle is stopped with the engine running, always apply the parking brake for safety.

1. When the ignition switch is turned to the "ACC" or "ON" position, the initial screen will be displayed and the system will begin operating.



- After a few seconds, the "CAUTION" screen will be displayed.

2. Select **I Agree** (I Agree).



CONNECTING AND DISCONNECTING A USB MEMORY DEVICE/PORTABLE DEVICE

CONNECTING A DEVICE

1. Connect a device.

▶ 11.6-inch display system/11.6-inch display with Navi system

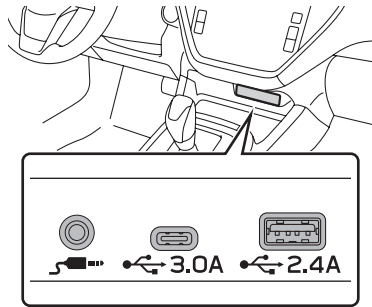

▶ Dual 7.0-inch display system

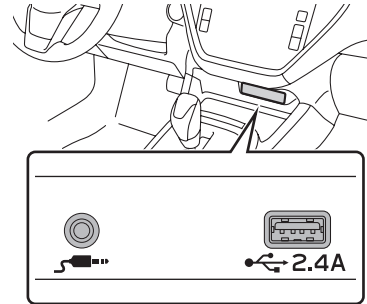





- Turn on the power of the device if it is not turned on.

NOTE

- Compatible USB memory device: →P.188
- Compatible iPod/iPhone: →P.188
- This unit does not support commercially available USB hubs.
- By connecting a device such as a cellular phone, charging starts depending on the device.

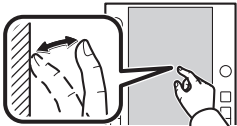
TOUCH SCREEN GESTURES

Operations are performed by touching the touch screen directly with your finger.

Operation method	Outline	Main use
	Touch Quickly touch and release once.	Changing and selecting various settings
	Double Touch with one finger*1 Quickly touch and release twice with one finger.	Enlarging the scale of the map screen
	Drag*2 Touch the screen with your finger, and move the screen to the desired position.	<ul style="list-style-type: none"> • Scrolling the lists • Scrolling the map screen*1
	Drag with two fingers*1 Touch the screen with two fingers and move the displayed screen as desired.	Changing the displayed angle of the 3D map screen

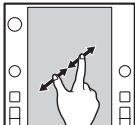
Operation method	Outline	Main use
	Swipe*2 Quickly move the screen by swiping with your finger.	<ul style="list-style-type: none"> • Scrolling the lists • Scrolling the map screen*1
	Pinch*1 Move your two fingers further apart (pinch-out) to zoom in the map. Move your two fingers closer together (pinch-in) to zoom out the map.	Changing the scale of the map screen

*1: 11.6-inch display with Navi system only

*2: The above operations may not be performed on all screens.

NOTE

- Swipe operations may not be performed smoothly in high altitudes.

TOUCH SCREEN OPERATION

This system is operated mainly by the buttons on the screen.
(Referred to as screen buttons in this manual.)

- When a screen button is touched, a tone sounds. The tone sound can be adjusted. (→P.98)



CAUTION

- To prevent damaging the screen, lightly touch the screen buttons with your finger.
- Do not use objects other than your finger to touch the screen.
- Wipe off fingerprints using a glass cleaning cloth. Do not use chemical cleaners to clean the screen, as they may damage the touch screen.

NOTE

- If the system does not respond to touching a screen button, move your finger away from the screen and then touch it again.
- Dimmed screen buttons cannot be operated.
- The displayed image may become darker and moving images may be slightly distorted when the screen is cold.
- When it is extremely cold, screens may not be displayed properly and the data input by a user may be deleted. Also, the screen buttons may not operate correctly.

NOTE

- When  is displayed on the screen, select  to close a pop-up screen.
- If the touch screen is operated while wearing gloves, it may be unresponsive or may not function properly.

ENTERING LETTERS AND NUMBERS/ LIST SCREEN OPERATION

ENTERING LETTERS AND NUMBERS

When entering data, letters and numbers can be entered via the screen.

► **Type A**



1	Select to move the cursor.
2	Input field • The position of the cursor can be moved by selecting the desired location in the input field.
3	Select to clear the input field.
4	Select to erase one character.
5	Select to enter the item.
6	Select to change keyboard types.
7	Select to enter symbols.
8	Select to enter characters in lower case or in upper case.

▶ Type B

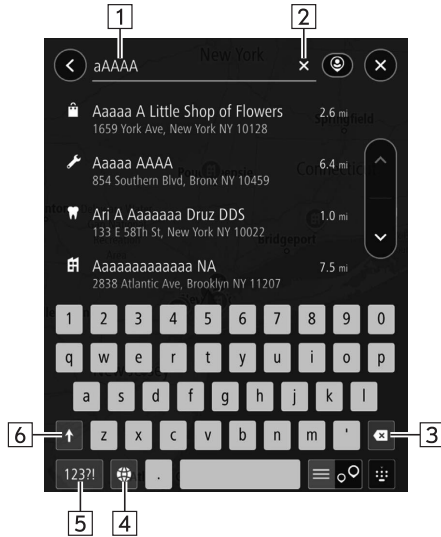

1

Input field

- The position of the cursor can be moved by selecting the desired location in the input field.

2

Select to clear the input field.

3

Select to erase one character.

4

Select to change keyboard types.

5

Select to enter symbols.

6

Select to enter characters in lower case or in upper case.

- : Enables capital letter input of one character only.
- : Enables capital letter input successively.

NOTE

- The appearance of the keyboard may change or the input method may be limited depending on the circumstances where the software keyboard is displayed.

2

LIST SCREEN OPERATION

The list screen can be scrolled by a swipe gesture.

For details on the operation: →P. 70

► 11.6-inch display system/11.6-inch display with Navi system

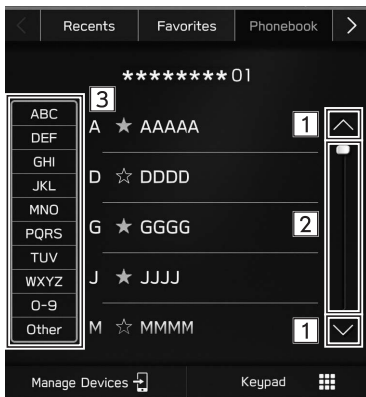

- | | |
|----------|--|
| 1 | Select to skip to the next or previous page. |
| 2 | This indicates the displayed screen's position.
To scroll: Drag the position indicator.
To jump: Touch the desired position of the rail. |
| 3 | Some lists contain character screen buttons which allow users to jump directly to list entries that begin with the same letter as the character screen button.
Every time the same character screen button is selected, the list starting with the subsequent character is displayed. |

► Dual 7.0-inch display system



SCREEN ADJUSTMENT

ADJUSTING BRIGHTNESS

The brightness of the screen can be adjusted.
Refer to the vehicle Owner's Manual for details.

CHANGING BETWEEN DAY AND NIGHT MODE (11.6-inch display with Navi system only)



The screen mode of the map screen changes to day or night mode depending on the position of the headlight switch. The screen's mode also changes to day or night mode depending on the position of the illumination brightness control dial, and surrounding brightness.

STATUS DISPLAY

The status of the Bluetooth connection, etc. is displayed on the screen.

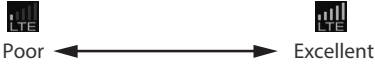

1	Display an outside temperature. Unit of measurements displayed can be changed. Refer to the vehicle Owner's Manual.
2	Display a current time. Select to display the clock setting screen.
3	This icon is displayed when the audio system volume is mute.
4 *1	<div style="text-align: center;">  </div> <p>Display the level of Wi-Fi® reception. When Wi-Fi® function is off, no item is displayed.</p>

<p>5 *2*3</p>	 <p>Display the level of Wi-Fi® Hotspot reception. When Wi-Fi® Hotspot function is off, no item is displayed.</p>
<p>6</p>	<p>This icon is displayed when the Bluetooth connection is established.</p>
<p>7</p>	 <p>Display the level of phone reception. If a cellular phone is not connected via Bluetooth, this icon will not be displayed. The level of reception does not always correspond with the level displayed on the cellular phone. The level of reception may not be displayed depending on the phone you have.</p>
<p>8</p>	 <p>Display the remaining of Bluetooth device battery charge. The amount displayed does not always correspond with the amount displayed on the Bluetooth device.</p>

*1: 11.6-inch display with Navi system only

*2: If equipped

*3: Refer to the Owner's Manual supplement for "SUBARU STARLINK Safety and Security" for details.

HOME SCREEN OPERATION

ADDING SHORTCUT ICONS TO THE HOME SCREEN

Shortcut icons for various functions can be added to the home screen when the home screen shortcut function is turned on. (→P.92)

1. Display the home screen. (→P.19, 43)
2. Select **Add Shortcut** (Add Shortcut).
3. Select the desired function.
4. Select the desired shortcut function.
 - Depending on the function, select other items and enter necessary information.
5. Check that the shortcut icon is displayed on the home screen.

NOTE

- When shortcuts are added, the home screen can be expanded to up to 3 pages (Dual 7.0-inch display system) or 4 pages (11.6-inch display system/11.6-inch display with Navi system). The page can be changed by swiping.

MOVING AND DELETING SHORTCUT ICONS



Users can rearrange the home screen buttons when the home screen shortcut function is turned on. (→P.92)

1. Select and hold the shortcut icon to enter edit mode.

▶ When moving shortcut icons

2. Drag the button to the desired position.
 - User can move buttons to another page by dragging them to the corresponding end of the screen if the number of buttons allows for multiple pages.

▶ When deleting shortcut icons

2. Drag the button to "DRAG HERE TO DELETE" area.
3. Press  (Dual 7.0-inch display system) or select  (11.6-inch display system/11.6-inch display with Navi system) to leave the edit mode.

3 Settings



Bluetooth® Settings 80

Registering A Bluetooth Phone/ Device For The First Time	80
Profiles	81
Bluetooth Settings	83
Phone Settings Screen	83
Registering A Bluetooth Phone/Device	84
Connecting Or Disconnecting Bluetooth Phone/Device	87
Deleting Bluetooth Phones/Devices	90
Setting Phonebook/Recent Calls Download	91

Other Settings 92

General Settings	92
General Settings Screen	92
Setting Wi-Fi® Connection	94
Updating The System	97
Sound Settings	98
Sound Settings Screen	98
Radio Settings	100
Setting AM/FM Radio	100
Setting The SiriusXM® Radio	101

Bluetooth® SETTINGS

REGISTERING A Bluetooth PHONE/ DEVICE FOR THE FIRST TIME

To use the hands-free system or the Bluetooth audio system, it is necessary to register a Bluetooth phone/device with the system.

Once the Bluetooth phone/device has been registered, it is possible to use the hands-free system and the Bluetooth audio system.

This operation cannot be performed while driving.

For details on registering a Bluetooth phone/device: →P.84

► 11.6-inch display system/11.6-inch display with Navi system

1. Turn the Bluetooth connection setting of your Bluetooth phone/device on.
 - This function is not available when the Bluetooth connection setting of your Bluetooth phone/device is set to off.
2. Select .
3. Follow the “STEPS 2 to 6” in “REGISTERING A Bluetooth PHONE/DEVICE”. (→P.84)

► Dual 7.0-inch display system

1. Turn the Bluetooth connection setting of your Bluetooth phone/device on.
 - This function is not available when the Bluetooth connection setting of your Bluetooth phone/device is set to off.
2. Display the phone screen. (→P.106)
3. Select **Yes** (Yes) to register a Bluetooth phone/device.

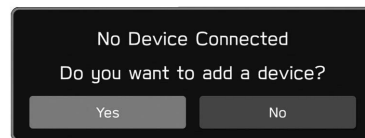

4. Follow the “STEPS 4 to 7” in “REGISTERING A Bluetooth PHONE/DEVICE”. (→P.84)

PROFILES

This system supports the following services.

Bluetooth Device	Spec.	Function	Requirements	Recommendations
Bluetooth Phone/Device	Bluetooth Specification	Registering a Bluetooth phone/device	Ver. 2.1	Ver. 5.0* ¹ Ver. 4.2* ²

Bluetooth Device	Profile	Function	Requirements	Recommendations
Bluetooth Phone	HFP (Hands-Free Profile)	Hands-free system	Ver. 1.0	Ver. 1.8* ¹ Ver. 1.7* ²
	PBAP (Phone Book Access Profile)	Transferring the contacts	Ver. 1.0	Ver. 1.2.3* ¹ Ver. 1.2* ²
	MAP (Message Access Profile)	Bluetooth phone message	-	Ver. 1.4.2* ¹ Ver. 1.3* ²
	SPP (Serial Port Profile)	APPS function	-	Ver. 1.2
Bluetooth Device	A2DP (Advanced Audio Distribution Profile)	Bluetooth audio system	Ver. 1.0	Ver. 1.3.2* ¹ Ver. 1.3* ²
	AVRCP (Audio/Video Remote Control Profile)		Ver. 1.0	Ver. 1.6.2* ¹ Ver. 1.6* ²

*1: 11.6-inch display system/11.6-inch display with Navi system

*2: Dual 7.0-inch display system

NOTE

- If your cellular phone does not support HFP, registering the Bluetooth phone or using PBAP, MAP or SPP profiles individually will not be possible.
- If the connected Bluetooth phone/device version is older than recommended or incompatible, the Bluetooth phone/device function may not work properly.
- If the application is not running smoothly or is unstable, disconnect and reconnect the Bluetooth phone/device via Bluetooth (→P.87) and/or USB cable (→P.69). If the problem continues, reboot the Bluetooth phone/device.

Bluetooth SETTINGS

1. Display the home screen. (→P.19, 43)
2. Select **Settings** (Settings).
3. → **Phone** (Phone)
4. Select the items to be set.

PHONE SETTINGS SCREEN

Manage Devices ▶	1
Phonebook/Recent Calls ▶	2
Message ▶	3
Change Device Name ***** ▶	4
Apple CarPlay ▶	5
Android Auto ▶	6

1	Registering a Bluetooth phone/device: →P.84
	Connecting or disconnecting Bluetooth phones/devices: →P.87
	Deleting Bluetooth phones/devices: →P.90

2	Setting phonebook/recent calls download: →P.91
	Sorting the recent calls list and contacts list: →P.111
	Deleting all favorites list: →P.112
3	Setting the message: →P.118
4	Changing the device name
5 *1	Setting Apple CarPlay: →P.135
6	Displays current Wi-Fi® password.*2 Generate (Generate): Generates a new password.
	Setting Android Auto*1: →P.140

*1: Dual 7.0-inch display system only

*2: 11.6-inch display system/11.6-inch display with Navi system only

NOTE

- “Manage Devices” screen can also be displayed by selecting **Manage Devices** (Manage Devices) or **Add Device** (Add Device) on the phone screen (→P.106) or Bluetooth audio control screen (→P.174) or  (11.6-inch display system/11.6-inch display with Navi system only).

REGISTERING A Bluetooth PHONE/DEVICE

Up to 7 (11.6-inch display system/11.6-inch display with Navi system) or 5 (Dual 7.0-inch display system) Bluetooth phones/devices can be registered.

Bluetooth compatible phones (HFP) and devices (AVP) can be registered simultaneously.



This operation cannot be performed while driving.

► 11.6-inch display system/11.6-inch display with Navi system

1. Select .
2. Select **Add** (Add).
 - If a message appears, follow the guidance on the screen.

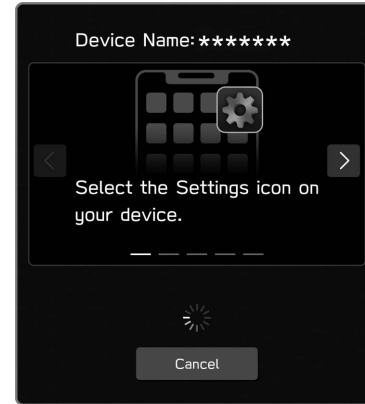
3. Follow instructions displayed to operate the Bluetooth phone/device.



-  / : Select to scroll the instructions.
- **Cancel** (Cancel): Select to cancel the registration.
- For details on operating the Bluetooth phone/device, see the manual that comes with it.

4. Register using your Bluetooth phone/device.
 - A PIN-code is not required for SSP (Secure Simple Pairing) compatible Bluetooth phones/devices. Depending on the type of Bluetooth phone/device being connected, a message confirming registration may be displayed on the Bluetooth phone's/device's screen. Respond and operate the Bluetooth phone/device according to the confirmation message.

NOTE

- To re-register your Bluetooth phone/device after having deleted it from the system, operate the Bluetooth phone/device and register it after deleting the previously registered system information from the Bluetooth phone/device.
5. Check that the following pop-up screen may be displayed.

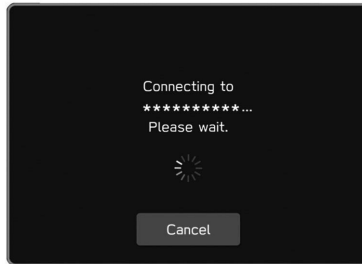

- **Cancel** (Cancel): Select to cancel the registration.
- If a confirmation message appears asking whether to transfer the phone's contact data to the system, select the appropriate button.

6. When the connection is completed, confirm that a connected device name is displayed.
 - If an error message appears, follow the guidance on the screen to try again.

NOTE

- When registering an NFC compatible device, registration is performed when the Bluetooth phone/device is held against the NFC logo of the audio system until a connection is established.

► Dual 7.0-inch display system

1. Display the phone settings screen. (→P.83)
2. Select **Manage Devices** (Manage Devices).
3. → **Add** (Add)
 - If a message appears, follow the guidance on the screen.

- Follow instructions displayed to operate the Bluetooth phone/device.

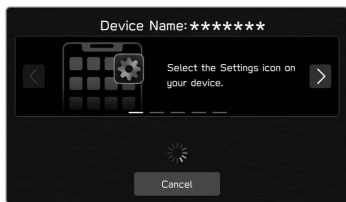

- **</>**: Select to scroll the instructions.
 - **Cancel** (Cancel): Select to cancel the registration.
 - For details on operating the Bluetooth phone/device, see the manual that comes with it.
- Register using your Bluetooth phone/device.
 - A PIN-code is not required for SSP (Secure Simple Pairing) compatible Bluetooth phones/devices. Depending on the type of Bluetooth phone/device being connected, a message confirming registration may be displayed on the Bluetooth phone's/device's screen. Respond and operate the Bluetooth phone/device according to the confirmation message.

NOTE

- To re-register your Bluetooth phone/device after having deleted it from the system, operate the Bluetooth phone/device and register it after deleting the previously registered system information from the Bluetooth phone/device.

- Check that the following pop-up screen may be displayed.

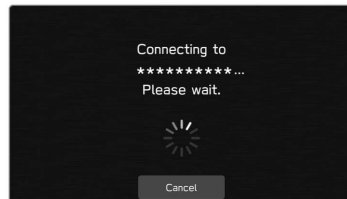

- **Cancel** (Cancel): Select to cancel the registration.
 - If a confirmation message appears asking whether to transfer the phone's contact data to the system, select the appropriate button.
- When the connection is completed, confirm that a connected device name is displayed.
 - If an error message appears, follow the guidance on the screen to try again.

CONNECTING OR DISCONNECTING Bluetooth PHONE/DEVICE



▶ 11.6-inch display system/11.6-inch display with Navi system

Up to 7 Bluetooth phones/devices (Phones (HFP) and devices (AVP)) can be registered.

If more than 1 Bluetooth phone/device has been registered, select which Bluetooth phone/device to connect to.

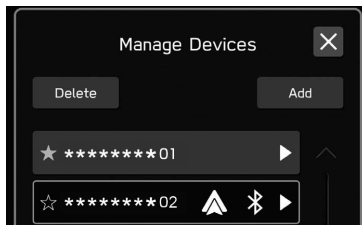
1. Select .
2. Select the Bluetooth phone/device to be connected or disconnected.



- Selecting  besides the name of the desired Bluetooth phone/device changes the icon to  (yellow). The selected Bluetooth phone/device will be registered as a favorite and moved to the top of the list. When the ignition switch is turned to the “ACC” or “ON” position, the favorite-registered device will be connected automatically. (→P.89)

- Bluetooth phone/device currently being connected is displayed in blue frame. Enabled functions are displayed besides the characters.
 - If the desired Bluetooth phone/device is not on the list, select **Add** (Add) to register the Bluetooth phone/device. (→P.84)
3. To connect/disconnect the Bluetooth phone/device, select “Connect” at the top or select “Bluetooth” of “Connection Preference” at the bottom.
 - By using “Connection Preference”, function connected when the Bluetooth phone/device is connected can be selected.

- If an error message appears, follow the guidance on the screen to try again.



1	Select to connect/disconnect Bluetooth.
2 *	Select to connect/disconnect Apple CarPlay.
3 *	Select to connect/disconnect Android Auto.
4	Select to connect/disconnect SUBARU STARLINK.

*: Displayed if the function is enabled when registered.

NOTE

- It may take time if the Bluetooth phone/device connection is carried out during Bluetooth audio playback.
- Depending on the type of Bluetooth phone/device being connected, it may be necessary to perform additional steps on the Bluetooth phone/device.

► Dual 7.0-inch display system

Up to 5 Bluetooth phones/devices (Phones (HFP) and devices (AVP)) can be registered.

If more than 1 Bluetooth phone/device has been registered, select which Bluetooth phone/device to connect to.

1. Display the phone settings screen. (→P.83)
2. Select **Manage Devices** (Manage Devices).
3. Select the Bluetooth phone/device to be connected or disconnected.

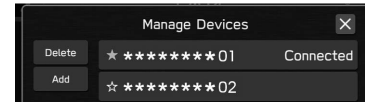

- To disconnect the Bluetooth phone/device, select **Yes** (Yes).
- “Connected” is displayed next to the currently connected Bluetooth phone/device.

- Selecting ☆ besides the name of the desired Bluetooth phone/device changes the icon to ★ (yellow). The selected device will be moved to the top of the list.
 - If the desired Bluetooth phone/device is not on the list, select **Add** (Add) to register the Bluetooth phone/device. (→P.84)
4. Check that “Connected” is displayed next to the Bluetooth phone/device when the connection is complete.
- If an error message appears, follow the guidance on the screen to try again.

NOTE

- It may take time if the Bluetooth phone/device connection is carried out during Bluetooth audio playback.
- Depending on the type of Bluetooth phone/device being connected, it may be necessary to perform additional steps on the Bluetooth phone/device.

AUTO CONNECTION MODE

Leave the Bluetooth phone/device in a location where the connection can be established.

- When the ignition switch is turned to the “ACC” or “ON” position, the system searches for a nearby registered Bluetooth phone/device.
- If a nearby registered Bluetooth phone/device is registered to favorite, the device will be connected automatically. (→P.87)
If there are no devices registered to favorite, the system will connect with the registered Bluetooth phone/device that was last connected, if it is nearby.

CONNECTING MANUALLY

When the auto connection has failed, it is necessary to connect Bluetooth phones/devices manually.

Follow the “CONNECTING OR DISCONNECTING Bluetooth PHONE/DEVICE”. (→P.87)



RECONNECTING THE Bluetooth PHONE/DEVICE

If a Bluetooth phone/device is disconnected due to poor reception from the Bluetooth network when the ignition switch is turned to the “ACC” or “ON” position, the system automatically reconnects the Bluetooth phone/device.

- If a Bluetooth phone/device is disconnected on purpose, such as turning it off, this does not happen. Reconnect the Bluetooth phone/device manually.

DELETING Bluetooth PHONES/DEVICES

► 11.6-inch display system/11.6-inch display with Navi system

1. Select .
2. Select **Delete** (Delete).
3. Select  for the Bluetooth phone/device you wish to delete.
4. Select **OK** (OK) when the confirmation message appears.

NOTE

- The Bluetooth phone/device will still contain information from this system even after the Bluetooth phone/device has been deleted. Operate the Bluetooth phone/device to delete the system information saved inside the Bluetooth phone/device.

► Dual 7.0-inch display system

1. Display the phone settings screen. (→P.83)
2. Select **Manage Devices** (Manage Devices).
3. → **Delete** (Delete)
4. Select  for the Bluetooth phone/device you wish to delete.
5. Select **OK** (OK) when the confirmation message appears.

NOTE

- The Bluetooth phone/device will still contain information from this system even after the Bluetooth phone/device has been deleted. Operate the Bluetooth phone/device to delete the system information saved inside the Bluetooth phone/device.

SETTING PHONEBOOK/RECENT CALLS DOWNLOAD

When this function is activated, the phonebook data of the connected Bluetooth phone will be downloaded automatically.

1. Display the phone settings screen. (→P.83)
2. Select **Phonebook/Recent Calls** (Phonebook/Recent Calls).
3. Select to turn “Automatically Download Phonebook/Recent Calls” on/off.

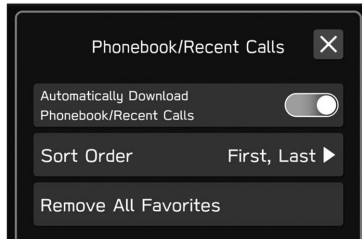

NOTE

- The profile version of the connected Bluetooth phone may not be compatible with downloading phonebook data. For details, contact your SUBARU dealer.
- Up to 2000 contacts in the phonebook of the connected Bluetooth phone can be downloaded. Up to 5 phone numbers registered to a contact can be downloaded.
- The notification setting on the Bluetooth phone may need to be activated in order to download the phonebook. For details, check the instructions for the connected Bluetooth phone. When the system's clock settings are set to auto, the auto-adjustment function and message function (→P.117) will not function properly if the phonebook is not downloaded.
- The Bluetooth phone's favorite list will not be downloaded automatically even after the phonebook data has been downloaded from the Bluetooth phone. This system does not currently support transfer of data from the Bluetooth phone favorites list. To add the Bluetooth phone's favorites list to the system's favorites list, you need to register it through the system phonebook contacts list. (→P.112)

OTHER SETTINGS

GENERAL SETTINGS

1. Display the home screen. (→P.19, 43)
2. Select **Settings** (Settings).
3. → **General** (General)
4. Select the items to be set.

GENERAL SETTINGS SCREEN

For details about the following menu, refer to the vehicle Owner's Manual.

- **Clock** (Clock)
- **Display** (Display)
- **Reminder Screen** (Reminder Screen)
- **Valet Mode** (Valet Mode)
- **Meter Screen** (Meter Screen)
- **Camera** (Camera)
- **Climate Control** (Climate Control)
- **Temperature Units** (Temperature Units)
- **Language** (Language)
- **Tire Pressure Units** (Tire Pressure Units)
- **Welcome Screen** (Welcome Screen)
- **Goodbye Screen** (Goodbye Screen)

- **Favorite Widgets** (Favorite Widgets)
- **Birthday List** (Birthday List)
- **Anniversary List** (Anniversary List)



Wi-Fi Settings (Wi-Fi Settings)* ¹	Select to set the Wi-Fi® function settings. (→P.94)
Wi-Fi Security Information (Wi-Fi Security Information)* ^{2*3}	Select to display Wi-Fi® security type that Wireless Apple CarPlay or Wireless Android Auto uses.
Wi-Fi Hotspot (Wi-Fi Hotspot)* ^{4*5}	Select to set the Wi-Fi® Hotspot settings.
Home Screen Shortcuts (Home Screen Shortcuts)	Select to turn the home screen shortcuts function on/off. (→P.76)

Periodic Rest Notification (Periodic Rest Notification)* ¹	Select to turn the display for the periodic rest notification pop-up screen on/off. (→P.198)
Software Update (Software Update)* ^{4*5}	The system software can be updated via DCM (Data Communication Module). (→P.97)
SUBARU STARLINK Apps Recovery (SUBARU STARLINK Apps Recovery)	Select to recover the SUBARU STARLINK.
SUBARU STARLINK Auto Connect (SUBARU STARLINK Auto Connect)* ^{6*7}	Select to turn the SUBARU STARLINK auto connect function on/off. (→P.127)
Factory Data Reset (Factory Data Reset)	Select to reset all setup items. The audio system restarts automatically after resetting factory data. To complete the reset process, turn the ignition switch to the "LOCK"/"OFF" position after the audio system has restarted, and then turn to the "ACC" or "ON" position after approximately 3 minutes.
System Information (System Information)	Select to display the system information.

Free/Open Source Software Information

(Free/Open Source Software Information)

Select to display the free/open source software information.

*¹: 11.6-inch display with Navi system only*²: 11.6-inch display system/11.6-inch display with Navi system only*³: Displayed when Wireless Apple CarPlay/Wireless Android Auto is used.*⁴: If equipped*⁵: Refer to the Owner's Manual supplement for "SUBARU STARLINK Safety and Security" for details.*⁶: Displayed when SUBARU STARLINK application is used.*⁷: Dual 7.0-inch display system only

SETTING Wi-Fi® CONNECTION (11.6-inch display with Navi system only)

CONNECTING TO A Wi-Fi® NETWORK

1. Display the general settings screen. (→P.92)
2. Select **Wi-Fi Settings** (Wi-Fi Settings).
3. → **Available Wi-Fi Networks** (Available Wi-Fi Networks)
4. Select the desired network.

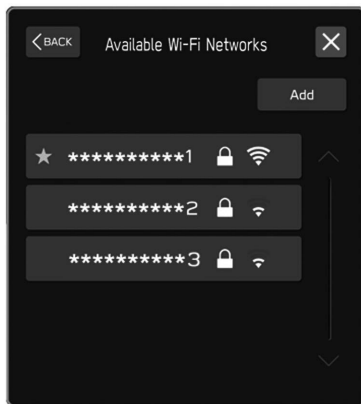

- When a network with **🔒** is selected and the password entry screen is displayed, enter the password, and then select **OK** (OK).

SETTING UP A CONNECTION QUICKLY

If a Wi-Fi® device is Wi-Fi® Protected Setup compatible, it can be connected to more quickly.

1. Display the general settings screen. (→P.92)
2. Select **Wi-Fi Settings** (Wi-Fi Settings).
3. → **Wi-Fi Protected Setup** (Wi-Fi Protected Setup)
4. Select **PIN Setup** (PIN Setup) or **Push Button Setup** (Push Button Setup) as determined by the device.
5. Operate the Wi-Fi® device to connect.
 - When **PIN Setup** (PIN Setup) is selected: Enter the displayed PIN code into the Wi-Fi® network device.
 - When **Push Button Setup** (Push Button Setup) is selected: Push the WPS button on the Wi-Fi® network device.

ADDING A Wi-Fi® NETWORK

Available networks which are not displayed by searching can be added.

1. Display the general settings screen. (→P.92)
2. Select **Wi-Fi Settings** (Wi-Fi Settings).
3. → **Available Wi-Fi Networks** (Available Wi-Fi Networks)
4. → **Add** (Add)
5. → **Wi-Fi Name (SSID)** (Wi-Fi Name (SSID))
6. Enter the network name. → **OK** (OK)
7. → **Security** (Security)
8. Select the security type.
9. → **Start Connection** (Start Connection)
 - When a password is required, enter the password. → **OK** (OK)

DELETING A Wi-Fi® NETWORK

1. Display the general settings screen. (→P.92)
2. Select **Wi-Fi Settings** (Wi-Fi Settings).
3. Select **Wi-Fi** (Wi-Fi) to turn the Wi-Fi® function off.
4. → **Registered Wi-Fi Networks** (Registered Wi-Fi Networks)
5. → **Delete** (Delete)
6. Select  for the Wi-Fi® network you wish to delete. → **OK** (OK)

⚠ WARNING

- Use Wi-Fi® devices only when safe and legal to do so.
- This system is fitted with Wi-Fi® antennas. People with implantable cardiac pacemakers, cardiac resynchronization therapy-pacemakers or implantable cardioverter defibrillators should maintain a reasonable distance between themselves and the Wi-Fi® antennas. The radio waves may affect the operation of such devices.
- Before using Wi-Fi® devices, users of any electrical medical device other than implantable cardiac pacemakers, cardiac resynchronization therapy-pacemakers or implantable cardioverter defibrillators should consult the manufacturer of the device for information about its operation under the influence of radio waves.

Radio waves could have unexpected effects on the operation of such medical devices.

SUPPORTED Wi-Fi® NETWORK SPECIFICATIONS

The system can connect to a Wi-Fi® network that supports the following standards.

- Communication standards:
 - IEEE802.11a
 - IEEE802.11b
 - IEEE802.11g
 - IEEE802.11n
 - IEEE802.11ac
- Security:
 - WPA™
 - WPA2™
 - WPA3™

NOTE

- WPA, WPA2 and WPA3 are registered mark of the Wi-Fi Alliance®.
- As the frequency band used for Wi-Fi® differs by country or region, it may not be possible to use 5GHz band.

UPDATING THE SYSTEM

Please ask your dealer to update the system software*1.

11.6-inch display system/11.6-inch display with Navi system equipped with DCM (Data Communication Module) only: You may also update the system software via DCM (Data Communication Module). The update process involves downloading and installing a software update*2. Note that system functionality will be restricted during installation.

*1: Please check with your dealer for specific details on the update content.

*2: Depending on the software update content, your radio station presets and volume settings may be reset by the update process.

NOTE

- Update using DCM (Data Communication Module) may not be available in some countries.

DOWNLOAD UPDATE

Updated software will be downloaded automatically.

When download is completed, a message asking if installation is desired or not will be displayed. (→P.97)

UPDATE INSTALLATION

CAUTION

- Park your vehicle in a safe place when installing the update.
- The following system functions are restricted during the update installation.
 - It will not be possible to use general system functions.
 - Only the rear view camera image will be displayed. Or the image will disappear temporarily.

1. When a message asking if installation is desired or not is displayed, select **Yes** (Yes).
 - Installation will take several minutes.
 - **Remind Me Later** (Remind Me Later): Select to extend the installation timing by up to twice.

NOTE

- During software update installation, the screen may flicker. However, this is not a malfunction.

2. When installation is complete, select **OK** (OK) on the confirmation message.
 - If the update procedure fails, refer to the "TROUBLESHOOTING" section. (→P.248)
3. Turn the ignition switch to the "LOCK"/"OFF" position and exit the vehicle.
4. Close the driver's door and lock the doors, then move at least 10 feet (3 m) away from the vehicle to prevent the key from interfering.
5. After at least 5 minutes have elapsed, start the engine again.
 - The new software will be applied.

SOUND SETTINGS

1. Display the home screen. (→P.19, 43)
2. Select **Settings** (Settings).
3. → **Sound** (Sound)
4. Select the items to be set.

SOUND SETTINGS SCREEN

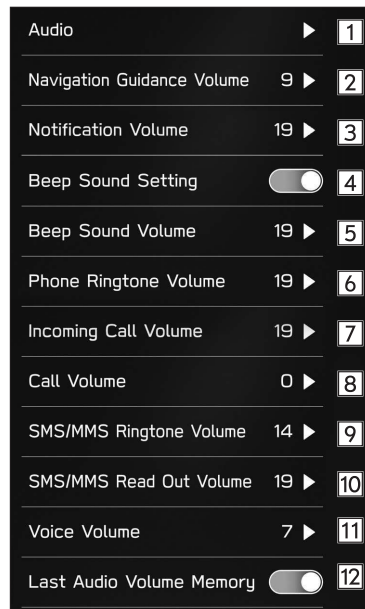

1	<p>Sound Customization (Sound Customization): Select to display the sound customization screen. (→P.153)</p> <p>Sound Restorer (Sound Restorer)*1: Select to turn the sound restorer function on/off. This function plays compressed audio with quality near original sound by adding the complement signal of high tone.</p> <p>Virtual Bass (Virtual Bass)*1: Select to set the virtual bass function. This function corrects the bass sound by adding harmonic sound.</p> <p>Dynamic Beat Enhancer (Dynamic Beat Enhancer)*1: Select to set the dynamic beat enhancer function. This function expands the dynamic range lost in data compression and creates a sharp beat sound.</p> <p>Speed Volume Control (Speed Volume Control)*1: Select to set the speed volume. The system adjusts to the optimum volume and tone quality according to vehicle speed to compensate for increased vehicle noise.</p> <p>AUX Volume Gain (AUX Volume Gain): Select to set AUX volume gain.</p>
2 *2	Select to set the navigation prompt volume.
3 *3	Select to adjust the interrupt guidance volume.
4	Select to turn the tone sound on/off.

5	Select to adjust the tone sound volume.
6	Select to adjust the ringtone volume.
7	Select to adjust the volume of a received call.
8	Select to adjust the call volume.
9	Select to adjust the SMS/MMS ringtone volume.
10	Select to adjust the SMS/MMS read out volume.
11	Select to set the voice recognition prompts volume.
12	<p>Select to enable/disable memorizing the volume level of the audio source.</p> <p>When enabled and when the ignition switch is turned from "LOCK/OFF" to "ACC" or "ON", the volume level of the audio source last used will be recalled.</p>

*1: This setting can be made depending on the connected amplifier type.

*2: 11.6-inch display with Navi system only

*3: 11.6-inch display system/Dual 7.0-inch display system only

RADIO SETTINGS

1. Display the home screen. (→P.19, 43)
2. Select **Settings** (Settings).
3. → **Radio** (Radio)

SETTING AM/FM RADIO

1. Display the radio settings screen. (→P.100)
2. Select **AM** (AM) or **FM** (FM).
3. Select the desired item to be set.

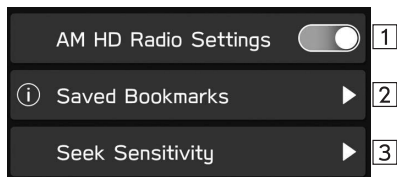

1	Select to turn the HD Radio mode on/off.
2	Select to display the saved bookmark list. (→P.100)
3 *	Select to set seek sensitivity of AM band as DX (Distance) (DX (Distance)) or LO (Local) (LO (Local)).

*: AM radio only



DISPLAYING THE BOOKMARK DETAILS

Cover art/track title/artist/album name are displayed for bookmarked tracks.

A QR code containing the track title/artist/album name can be displayed.

1. Display the AM settings screen or FM settings screen. (→P.100)
2. Select **Saved Bookmarks** (Saved Bookmarks).
3. Select the desired bookmark.

DELETING THE BOOKMARK

1. Display the AM settings screen or FM settings screen. (→P.100)
2. Select **Saved Bookmarks** (Saved Bookmarks).
3. → **Edit** (Edit)
4. Select  for the bookmark you wish to delete. → **OK** (OK)
 - Deleting the bookmark can also be deleted select to  from the bookmark details screen.

SETTING THE SiriusXM® Radio

1. Display the radio settings screen. (→P.100)
 2. Select **SiriusXM** (SiriusXM).
 3. Select the desired item to be set.
- ▶ **11.6-inch display system/11.6-inch display with Navi system**

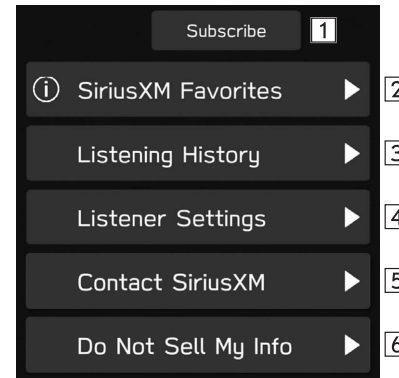

1	Select to enter into a contract for the package plan of the SiriusXM®.
2	Select to register desired channels to favorite or display/edit registered favorites. <ul style="list-style-type: none"> • Select Add Current (Add Current) to register the current channel as a favorite. • Select a registered channel to display the screen for listening.

3	Select to select a channel from listening history of SiriusXM® Radio.
4	Select to set the Listener Settings. (→P.103)
5	Select to display the phone number of SiriusXM® customer care and your radio ID. Call (Call): Select to make a call when a Bluetooth-compatible phone is connected.
6	Select to display descriptions regarding Do Not Sell My Info.

► Dual 7.0-inch display system

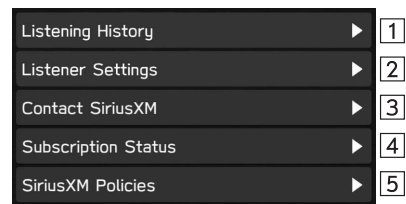

1	Select to select a channel from listening history of SiriusXM® Radio.
2	Select to set the Listener Settings. (→P.103)
3	Select to display the phone number of SiriusXM® customer care and your radio ID. Call (Call): Select to make a call when a Bluetooth-compatible phone is connected.
4	Select to display the subscription status of SiriusXM®, phone number of SiriusXM® customer care, and your radio ID. Call (Call): Select to make a call when a Bluetooth-compatible phone is connected.
5	Select to display the privacy policy of SiriusXM®.

SETTING THE LISTENER SETTINGS

1. Display the SiriusXM settings screen. (→P.101)
2. Select **Listener Settings** (Listener Settings).

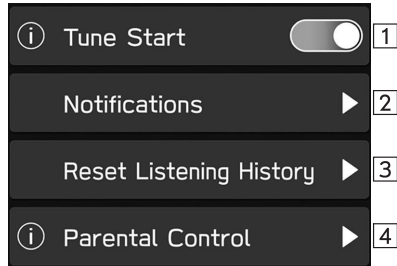

1	When this function is on, channels registered as Smart Favorites will be cached, and when the channel is changed, the song on that channel can be listened to from the beginning.
2	Select to enable/disable notification of registered sports teams or music artists/tunes, such as their game match starting time or tune to be played. Registered teams, artists, and tunes for notification can be edited.
3	Select to delete all the listening history.
4	Select to enable/disable parental control and to set passcode of the parental control screen. (→P.103)

SETTING THE PARENTAL CONTROL PASSCODE

1. Display the Listener Settings screen. (→P.103)
2. Select **Parental Control** (Parental Control).
3. Select **OK** (OK) when the confirmation message appears.
4. Enter the 4 digits passcode. → **OK** (OK)

ENABLING/DISABLING PARENTAL CONTROL

1. Display the Listener Settings screen. (→P.103)
2. Select **Parental Control** (Parental Control).
3. Enter the 4 digits passcode. → **OK** (OK)
4. Select to turn the "Block Explicit" on/off.

CHANGING THE PARENTAL CONTROL PASSCODE

1. Display the Listener Settings screen. (→P.103)
2. Select **Parental Control** (Parental Control).
3. Enter the 4 digits passcode. → **OK** (OK)
4. → **Change Passcode** (Change Passcode)
5. Enter the 4 digits current passcode. → **OK** (OK)
6. Enter the 4 digits new passcode. → **OK** (OK)

4 Phone



Phone Operation	106
Phone Screen	106
Some Basics	107
Registering/Connecting A Bluetooth Phone	108
Using The Phone Switch/Microphone	108
Voice Recognition System	109
About The Contacts In The Contact List	109
Calling On The Bluetooth Phone	110
By Recent Calls List	110
By Favorites List	111
By Keypad	112
By Contacts List	112

Receiving On The Bluetooth Phone	113
Incoming Calls	113
Talking On The Bluetooth Phone	114
Call Waiting	115
Bluetooth Phone Message Function	117
Setting The Message	118
Receiving A Message	118
Checking Messages	119
Replying To A Message (Quick Reply)	120
Sending A New Short Message	120
Editing The Quick Reply Message	120
Deleting The Quick Reply Message	121
Adding The Quick Reply Message	121
Calling The Message Sender	121

PHONE OPERATION (HANDS-FREE SYSTEM FOR CELLULAR PHONES)

PHONE SCREEN

The phone screen can be accessed with the following methods:

- Display the home screen (→P.19, 43), and then select **Phone** (Phone).
- Press the  switch on the steering wheel.
- Dual 7.0-inch display system only: Press **PHONE**.

▶ **11.6-inch display system/11.6-inch display with Navi system**

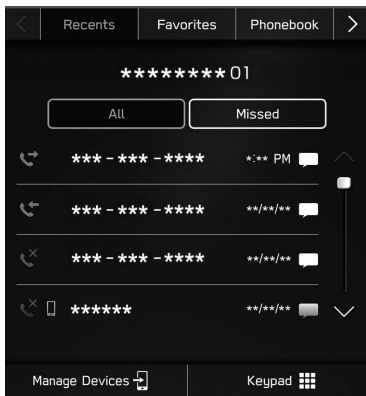

▶ **Dual 7.0-inch display system**

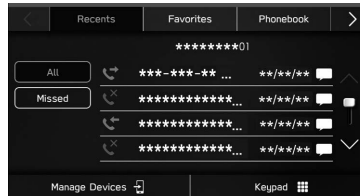

Phone operation	Registering a Bluetooth phone/device: →P.80
	Calling on the Bluetooth phone: →P.110
	Receiving on the Bluetooth phone: →P.113
	Talking on the Bluetooth phone: →P.114
Message function	Using the Bluetooth phone message function: →P.117
Setting up a phone	Setting the Bluetooth phone/device: →P.83

SOME BASICS

The hands-free system enables calls to be made and received without having to take your hands off the steering wheel.

This system supports Bluetooth. Bluetooth is a wireless data system that enables cellular phones to be used without being connected by a cable or placed in a cradle.

The operating procedure of the phone is explained here.

WARNING

- While driving, do not use a cellular phone or connect the Bluetooth phone.
- This system is fitted with Bluetooth antennas. People with implantable cardiac pacemakers, cardiac resynchronization therapy-pacemakers or implantable cardioverter defibrillators should maintain a reasonable distance between themselves and the Bluetooth antennas. The radio waves may affect the operation of such devices.
- Before using Bluetooth phones, users of any electrical medical device other than implantable cardiac pacemakers, cardiac resynchronization therapy-pacemakers or implantable cardioverter defibrillators should consult the manufacturer of the device for information about its operation under the influence of radio waves. Radio waves could have unexpected effects on the operation of such medical devices.

CAUTION

- Do not leave your cellular phone in the vehicle. The temperature inside may rise to a level that could damage the phone.

NOTE

- If your cellular phone does not support Bluetooth, this system cannot function. Certain functions may not be available depending on the type of cellular phone.
- In the following conditions, the system may not function:
 - The cellular phone is turned off.
 - The current position is outside the communication area.
 - The cellular phone is not connected.
 - The cellular phone has a low battery.
- When using the hands-free function and other Bluetooth functions at the same time, the following problems may occur:
 - The Bluetooth connection may be cut.
 - Noise may be heard when playing back voice with the Bluetooth function.
- The other party's voice will be heard from the front speakers. The audio system will be muted during phone calls or when hands-free voice commands are used.
- Talk alternately with the other party on the phone. If both parties speak at the same time, the other party may not hear what has been said. (This is not a malfunction.)
- Keep call volume down. Otherwise, the other party's voice may be audible outside the vehicle and voice echo may increase. When talking on the phone, speak clearly towards the microphone.

NOTE

- The other party may not hear you clearly when:
 - Driving on an unpaved road. (Making excessive traffic noise.)
 - Driving at high speeds.
 - Driving with a window open.
 - When air from the ventilator blows directly toward the microphone.
 - The sound of the air conditioning fan is loud.
 - There is a negative effect on sound quality due to the phone and/or network being used.

REGISTERING/CONNECTING A Bluetooth PHONE

To use the hands-free system for cellular phones, it is necessary to register a cellular phone with the system. (→P.80)

Bluetooth PHONE CONDITION DISPLAY

The condition of the Bluetooth phone appears on the upper right side of the screen. (→P.75)

USING THE PHONE SWITCH/MICROPHONE**► Steering switch**

By pressing the phone switch, a call can be received or ended without taking your hands off the steering wheel.

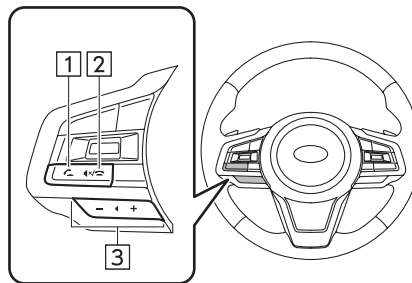

- 1 Off hook switch
- 2 On hook switch
- 3 Volume control switch
 - Press the "+" side to increase the volume.
 - Press the "-" side to decrease the volume.

► Microphone

The microphone is used when talking on the phone.

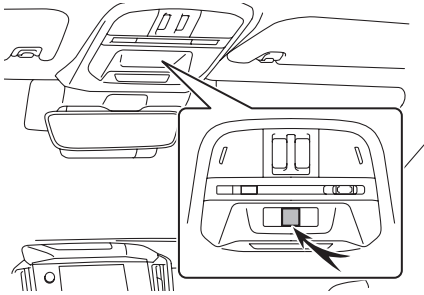

VOICE RECOGNITION SYSTEM

Press this switch to operate the voice recognition system.

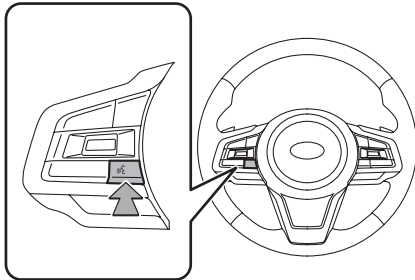

- The voice recognition system and its list of commands can be operated. (→P.226)

ABOUT THE CONTACTS IN THE CONTACT LIST

- The following data is stored for every registered phone. When another phone is connected, the following registered data cannot be read:
 - Contact data
 - Call history data
 - Favorites data
 - All phone settings

NOTE

- When a phone's registration is deleted, the above-mentioned data is also deleted.

CALLING ON THE Bluetooth PHONE

After a Bluetooth phone has been registered, a call can be made using the hands-free system. There are several methods by which a call can be made, as described below.

1. Display the phone screen. (→P.106)
2. Select the desired button to call from.
 - By recent calls list: →P.110
 - By favorites list: →P.111
 - By keypad*1: →P.112
 - By contacts list: →P.112
 - By SMS/MMS: →P.121
 - By POI call*2: →P.194
 - By voice recognition system: →P.226

*1: The operation cannot be performed while driving.

*2: 11.6-inch display with Navi system only

NOTE

- If Siri is activated on an iPhone which is connected to the system via Bluetooth, an active call screen of the connected iPhone will be displayed. The iPhone can be operated using Siri.

BY RECENT CALLS LIST

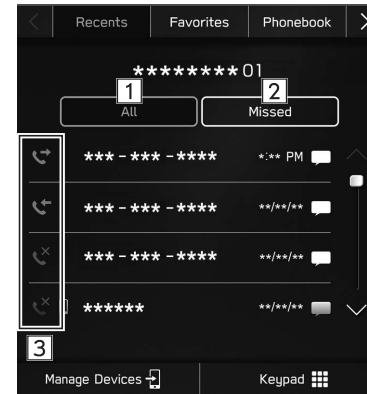

1. Display the phone screen. (→P.106)
2. Select **Recents** (Recents), and then select the desired contact.
 - The outgoing call screen is displayed.

► 11.6-inch display system/11.6-inch display with Navi system

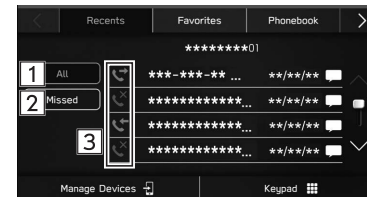

► Dual 7.0-inch display system



1	Select to display all latest call history items.
2	Select to display missed calls.
3	<p>Displays the call type icons.</p> <p> Missed call</p> <p> Incoming call</p> <p> Outgoing call</p>

NOTE

- Pressing  on the steering wheel will make a call to the phone number displayed at the top of the list.
- When a phone number registered in the contact list is received, the name is displayed.
- International phone calls may not be made depending on the type of cellular phone you have.

SORTING THE PHONEBOOK LIST

The order of the phonebook list can be sorted by first name or last name.

1. Display the phone settings screen. (→P.83)
2. Select **Phonebook/Recent Calls** (Phonebook/Recent Calls).
3. → **Sort Order** (Sort Order)
4. Select the desired sorting criteria.

BY FAVORITES LIST

Calls can be made using registered contacts which can be selected from a contact list.

For details on registering contacts:→P.112

Up to 15 contact lists can be registered in the favorites list.

1. Display the phone screen. (→P.106)
2. Select **Favorites** (Favorites), and then select the desired contact.
3. Select  next to the desired number.
 - The outgoing call screen is displayed.

NOTE

- This system's favorites list and that of your Bluetooth phone are not synchronized. This system does not currently support transfer of favorites list data from the Bluetooth phone. To add the Bluetooth phone's favorites list to the system's favorites list, you need to register it through the system phonebook contacts list. (→P.112)

DELETING ALL FAVORITES LIST

1. Display the phone settings screen. (→P.83)
2. Select **Phonebook/Recent Calls** (Phonebook/Recent Calls).
3. → **Remove All Favorites** (Remove All Favorites) → **OK** (OK)

BY KEYPAD

1. Display the phone screen. (→P.106)
2. Select **Keypad** (Keypad).
3. Enter the phone number. → **Call** (Call)
 - The outgoing call screen is displayed.

NOTE

- Depending on the type of Bluetooth phone being connected, it may be necessary to perform additional steps on the phone.

BY CONTACTS LIST

Calls can be made by using contact data which is downloaded from the connected Bluetooth phone.

1. Display the phone screen. (→P.106)
2. Select **Phonebook** (Phonebook), and then select the desired contact.
 - When ☆ is selected, ☆ changes to ★ (yellow).
 - The number is registered in the favorites list. (→P.111)
 - Each time the symbol is selected, the symbol changes between ☆ and ★ (yellow).
3. Select  next to the desired number.
 - Numbers may include Home, Work, Mobile and Other as categories depending on the phonebook data of the connected cellular phone.
 - The outgoing call screen is displayed.

NOTE

- Up to 2000 contacts can be downloaded and displayed on the phonebook screen. (Up to 5 phone numbers per contact will be downloaded.)
- When "Automatically Download Phonebook/Recent Calls" is set to on, contacts is downloaded automatically. (→P.91)

RECEIVING ON THE Bluetooth PHONE

INCOMING CALLS

When a call is received, the incoming call screen pops up with sound.

1. Select **Accept** (Accept) or press the  switch on the steering wheel to talk on the phone.

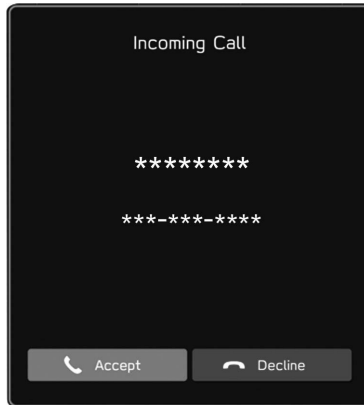

To refuse to receive the call: Select **Decline** (Decline) or press the  switch on the steering wheel.

To adjust the volume of a received call: Turn the "VOLUME" knob, or use the volume control switch on the steering wheel.

NOTE

- During international phone calls, the other party's name or number may not be displayed correctly depending on the type of cellular phone you have.
- The ringtone volume can also be set from the sound settings screen. (→P.98)

TALKING ON THE Bluetooth PHONE

While talking on the phone, this screen is displayed. The operations outlined below can be performed on this screen.

► 11.6-inch display system/11.6-inch display with Navi system





► Dual 7.0-inch display system







1	Select to mute your voice to the other party.
2	Select to enter the desired numbers/output tones.
3	Select to transfer the call. Select Transfer (Transfer) to change from a hands-free call to a cellular phone call. Select Transfer Back (Transfer Back) to change from cellular phone call to hands-free call.
4	When a call is put on hold by pressing the  switch on the steering wheel: Select to resume the on-hold call.
5	Select to hang up the phone.
6	Select to minimize the active call screen.

NOTE

- Pressing  switch on the steering wheel during a call will put the call on hold.
Pressing  switch on the steering wheel again will resume the on-hold call.
- Changing between cellular phone call and hands-free call can be performed by operating the cellular phone directly.
- Transferring methods and operations will be different depending on the type of cellular phone you have.
- For the operation of the cellular phone, see the manual that comes with it.
- Turn the “VOLUME” knob, or use the volume control switch on the steering wheel to adjust the volume of the other party’s voice.

► When using another function during a call

By selecting  (11.6-inch display system/11.6-inch display with Navi system), or pressing  (Dual 7.0-inch display system), the active call screen will be minimized and other functions can be used.

- When the active call screen is minimized, only the call ending operation can be performed.
- By selecting  (11.6-inch display system/11.6-inch display with Navi system), or pressing  (Dual 7.0-inch display system), the active call screen will be maximized.



CALL WAITING

When a call is interrupted by a third party while talking, the incoming call screen pops up with sound.

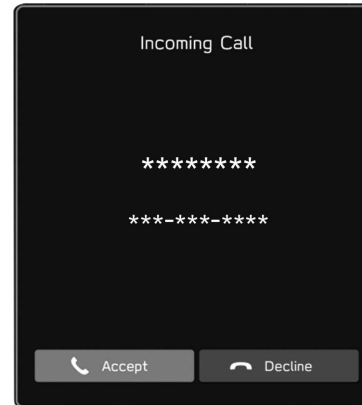
1. Select **Accept** (Accept) or press the  switch on the steering wheel to start talking with the other party.



- The first call is put on hold.

To refuse to receive the call: Select **Decline** (Decline) or press the  switch on the steering wheel. To end both the first call and second call, press and hold  on the steering wheel.



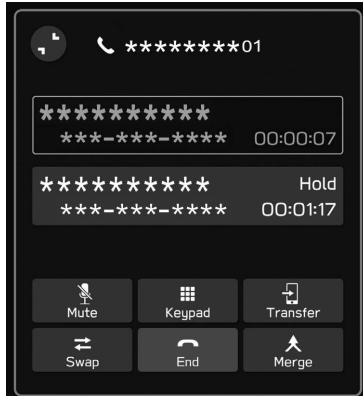

2. Check that the call waiting screen is displayed.

▶ 11.6-inch display system/11.6-inch display with Navi system

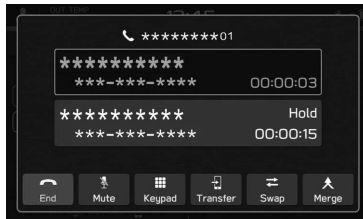

▶ Dual 7.0-inch display system



- **Swap** (Swap): Select to change parties. Each time **Swap** (Swap) or name area is selected, or press the  switch on the steering wheel, the party who is on hold will be switched.
- Select **Merge** (Merge) or press and hold the  switch on the steering wheel to change to a conference call.*
- Select **End** (End) or press the  switch on the steering wheel to end the call and return to the conversation with the party on hold when having a two-way conversation, and to end the call with both parties when having a three-way conversation.
- To end all of the calls connected, press and hold  switch on the steering wheel.

*: Depending on the company of the Bluetooth phone that is connected to the system, the conference call function may not be available.

Bluetooth PHONE MESSAGE FUNCTION

Received messages can be forwarded from the connected Bluetooth phone, enabling checking and replying using the system.

Depending on the type of Bluetooth phone connected, received messages may not be transferred to the message inbox.

If the phone does not support the message function, this function cannot be used.

Depending on the Bluetooth phone type, the screen display may differ, and it may not be possible to use certain functions.

To use this function, it is necessary to set the phonebook download function to on. (→P.91)

NOTE

- Depending on the model of your Bluetooth phone, the setting of the connected phone may need to be changed. (ex: For iOS or other models, the notification setting may need to be activated.) For details, check the instructions for the connected Bluetooth phone.

1. Display the phone screen. (→P.106)
2. Select **Messages** (Messages).
3. Check that the message inbox screen is displayed.

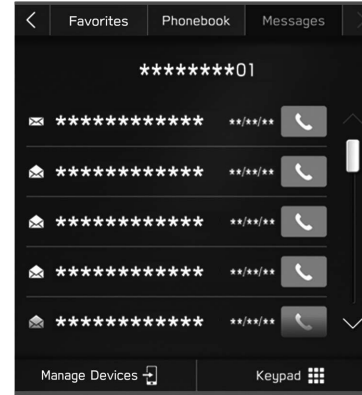

- : Unread message icon
- Receiving a message: →P.118
- Checking messages: →P.119
- Replying to a message (quick reply): →P.120
- Sending a new short message: →P.120
- Calling the message sender: →P.121

SETTING THE MESSAGE

1. Display the phone settings screen. (→P.83)
2. Select **Message** (Message).
3. Select the items to be set.

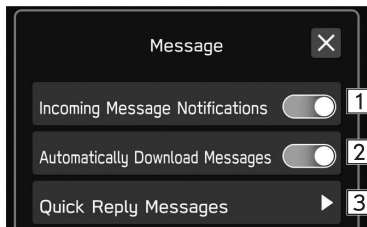

1	Select to set the incoming message notification pop-up on/off.
2	Select to set automatically download messages on/off.
3	Select to edit quick reply messages. (→P.120)

RECEIVING A MESSAGE

When an SMS/MMS is received, the incoming message screen pops up with sound and is ready to be operated on the screen.

1. Select **Play** (Play).
 - Select **Ignore** (Ignore) to not open the message.

► If there are any unread messages

The following screen is displayed.



- **Inbox** (Inbox): Select to display the message inbox screen.
- **Ignore** (Ignore): Select to not open the message.

2. The following screen is displayed.

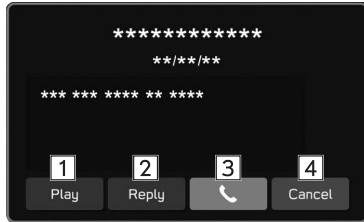

1	Select to have messages read out. • Select Stop (Stop) to stop the message read out.
2 *	Select to reply the message. (→P.120)
3	Select to call the message sender.
4	Select to close this screen.

*: Depending on the Bluetooth phone that is connected to the audio system, this function is not available.

NOTE

- Depending on the cellular phone used for receiving messages, or its registration status with the system, some information may not be displayed.

CHECKING MESSAGES

1. Display the message inbox screen. (→P.117)
2. Select the desired message from the list.
3. Check the message. (→P.118)

NOTE

- Depending on the type of Bluetooth phone being connected, it may be necessary to perform additional steps on the phone.
- Only received messages on the connected Bluetooth phone can be displayed.
- The text of the message is not displayed while driving.
- Turn the “**VOLUME**” knob, or use the volume control switch on the steering wheel to adjust the message readout volume.

REPLYING TO A MESSAGE (QUICK REPLY)*

*: Depending on the Bluetooth phone that is connected to the audio system, this function is not available.

1. Display the message inbox screen. (→P.117)
2. Select the desired message from the list.
3. → **Reply** (Reply)
4. Select the desired message.
5. → **Send** (Send)
 - **Change** (Change): Select to change the message.
 - **Cancel** (Cancel): Select to cancel sending the message.

NOTE

- 10 messages have already been stored.

SENDING A NEW SHORT MESSAGE

1. Display the favorites detail screen (→P.111), the recent calls list screen (→P.110) or the contact detail screen (→P.112).
2. Select  next to the desired number.
3. Select the desired message.
4. → **Send** (Send)
 - **Change** (Change): Select to change the message.
 - **Cancel** (Cancel): Select to cancel sending the message.

EDITING THE QUICK REPLY MESSAGE

► Editing the message in the phone settings screen

1. Display the phone settings screen. (→P.83)
2. Select **Message** (Message).
3. → **Quick Reply Messages** (Quick Reply Messages)
4. → **Edit** (Edit)
5. Select the desired message.
6. Enter the message. → **OK** (OK)

▶ Editing the message in the message screen

1. Display the message inbox screen. (→P.117)
2. Select the desired message from the list.
3. → **Reply** (Reply)
4. Select  next to the desired message.
5. Enter the message. → **OK** (OK)

DELETING THE QUICK REPLY MESSAGE

1. Display the phone settings screen. (→P.83)
2. Select **Message** (Message).
3. → **Quick Reply Messages** (Quick Reply Messages)
4. → **Edit** (Edit)
5. Select  next to the desired message.

ADDING THE QUICK REPLY MESSAGE

1. Display the phone settings screen. (→P.83)
2. Select **Message** (Message).
3. → **Quick Reply Messages** (Quick Reply Messages)
4. → **Add** (Add)
5. Enter the message. → **OK** (OK)

CALLING THE MESSAGE SENDER

Calls can be made to an SMS/MMS message sender's phone number.

1. Display the message inbox screen. (→P.117)
2. Select  next to the desired sender.
 - The outgoing call screen is displayed.

5 Apps

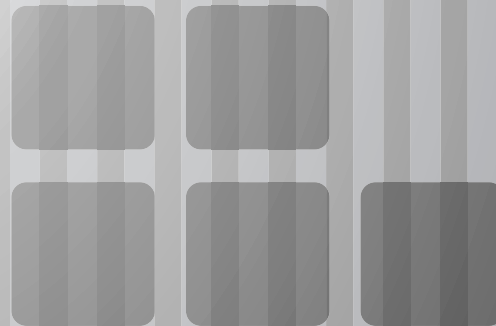

Before Using Applications 124

Before Using Applications	124
Settings Required To Use Applications	125
About App-based Connected Content	125
Communication Standards Regarding Application	126

SUBARU STARLINK 127

SUBARU STARLINK	127
Displaying SUBARU STARLINK Information	128
Legal Notice	128

Apple CarPlay 133

Apple CarPlay	133
Connecting The Apple CarPlay Device	134
Overview	134
Enabling Apple CarPlay	135
Selecting Device To Connect To Apple CarPlay	136
Disabling Apple CarPlay	136
Deleting The Apple CarPlay Device	136

Android Auto 137

Android Auto	137
Connecting An Android Auto Device	138
Overview	138
Enabling Android Auto	140
Selecting Android Auto Devices To Connect To Android Auto	140
Disabling Android Auto	140
Deleting The Android Auto Device	140

SiriusXM Travel Link 141

SiriusXM Travel Link	141
Displaying Sports Information	141
Displaying Weather Information	142
Displaying Weather Alerts	144
Displaying Stocks Information	145
Displaying Fuel Information	146
Displaying Parking Information	147

BEFORE USING APPLICATIONS

BEFORE USING APPLICATIONS

Precautions to be aware of when using applications are shown below.

In this chapter, iPhone or Android devices will be referred to as a smartphone.

 **WARNING**

- Do not connect or operate the smartphone while driving.
- Be sure to park the vehicle in a safe place before connecting or operating the smartphone.

 **CAUTION**

- Do not leave your smartphone in the vehicle. In particular, high temperatures inside the vehicle may damage the smartphone.
- Do not push down on or apply unnecessary pressure to the smartphone while it is connected as this may damage the smartphone or its terminal.
- If connecting your smartphone via USB, do not insert foreign objects into the USB port as this may damage the smartphone or its terminal.

NOTE

- Depending on the application, certain functions are not available while driving for reasons of safety.
- In order to maximize signal reception, performance and precision of the smartphone, please ensure the smartphone is placed as close to the system as possible, while ensuring it is stowed and secure while driving.
- When connecting your smartphone via USB, use the original cables provided with your smartphone or equivalent third-party (certified) cables.
- If a smartphone is connected to the USB port, turning the ignition switch to the "ACC" or "ON" position will start charging the smartphone.
- If connecting your smartphone via USB, smartphone may not be recognized when the ignition switch is turned to the "ACC" or "ON" position. In this case, remove the smartphone and reconnect it.
- The accuracy of the displayed information or the signal reception performance depends on the smartphone or the connected device, and its wireless connection.
- For operating the smartphone, see the instruction manual that comes with it.
- Follow the specific operation procedures for the smartphone application.
- When connecting the device via Bluetooth, the communication speed may become slower than via USB.
- If the application is not running smoothly or is unstable, disconnect and reconnect the smartphone via Bluetooth (→P.87) and/or USB cable (→P.69). If the problem continues, reboot the smartphone.

SETTINGS REQUIRED TO USE APPLICATIONS

In order to use an application on this system, the application must be installed on your smartphone.

- Search and download the application from your smartphone app.
 - iPhone: App Store via iTunes
 - Android device: Google Play Store
- Create an account and login to the application on the smartphone.

NOTE

- Please use the latest version of the application.
- Apple CarPlay does not require an application to be installed. Refer to "Apple CarPlay" for details on Apple CarPlay operation. (→P.133)

ABOUT APP-BASED CONNECTED CONTENT

Requirements for using the connected content services of the application on this system.

- The latest version of the system is compatible with connected content application(s) for the smartphones, and is downloaded to your smartphone.
- A current account with a wireless content service provider.
- A smartphone data plan: If the data plan for your smartphone does not provide for unlimited data usage, additional charges from your carrier may apply for accessing app-based connected content via 3G, 4G, Wi-Fi®, or 4G LTE wireless networks.
- Connection to the internet via 3G, 4G, Wi-Fi®, or 4G LTE networks.

NOTE

- Changes to product specifications may result in differences between the content of the manual and features of the product.
- Be careful not to exceed the data usage limits for your smartphone. Doing so will result in additional data usage charges from your phone carrier.

NOTE

- **Limitations:**
 - Access to app-based connected content will depend on the availability of wireless cellular and/or Wi-Fi® network coverage for the purpose of allowing your smartphone to connect to the internet.
 - Service availability may be geographically limited by region. Consult the wireless connected content service provider for additional information.
 - Ability of this product to access connected content is subject to change without notice and could be affected by any of the following: compatibility issues with future firmware versions of the smartphone; compatibility issues with future versions of the connected content application(s) for the smartphone; changes to or discontinuation of the connected content application(s) or service by its provider.
- Since some applications use signals from GPS satellites and wireless communication lines, they may not work properly in the following locations.
 - In tunnels
 - In underground parking lots
 - Outside wireless communication range, such as some countryside areas
 - Where the wireless communication network is congested, or where communications are restricted
- Depending on the circumstances and environment, the signal may be weak or not be received. In such cases, an error may occur.
- Communication and phone call charges for smartphones should be paid by the wireless subscriber.
- If you lose the data in a smartphone or other device while using it with the system, no compensation will be given for the lost data.

NOTE

- SUBARU CORPORATION does not guarantee content provided by the application.
- The application may not work due to factors on smartphones, smartphone applications or stations. SUBARU CORPORATION accepts no responsibility for this.

COMMUNICATION STANDARDS REGARDING APPLICATION

For connecting wireless Apple CarPlay or wireless Android Auto, Wi-Fi® communication is used. The vehicle is compatible with the following Wi-Fi® communication standards:

- **Communication standards:**
 - IEEE802.11a
 - IEEE802.11b
 - IEEE802.11g
 - IEEE802.11n
 - IEEE802.11ac
- **Security:**
 - WPA™
 - WPA2™
 - WPA3™

NOTE

- WPA, WPA2 and WPA3 are registered mark of the Wi-Fi Alliance®.
- As the frequency band used for Wi-Fi® differs by country or region, it may not be possible to use 5GHz band.

SUBARU STARLINK

SUBARU STARLINK

The SUBARU STARLINK app allows users to connect a smartphone to the system, using either Bluetooth or undamaged genuine USB cable (recommended), and access to various music, navigation, vehicle guide applications, and much more.

Download the SUBARU STARLINK app from the Apple App Store or Google Play Store.

When connecting iPhone or Android devices with the SUBARU STARLINK application installed, you can control SUBARU STARLINK content through the system.

To use the SUBARU STARLINK application, connect your iPhone to the USB port or via Bluetooth, or connect your Android device via Bluetooth.

Dual 7.0-inch display system/11.6-inch display system without SUBARU STARLINK Safety and Security only: It is necessary to pair your smartphone via Bluetooth (→P.87), set the phonebook download function to on (→P.91), and then adjust the time so that it is the same at both your smartphone and the system.

When using the application, read the precautions indicated in "BEFORE USING APPLICATIONS". (→P.124)

NOTE

- SUBARU CORPORATION reserves the right, in its sole and absolute discretion, to add, limit, or remove applications from SUBARU STARLINK at any time. Applications available at the time you purchase your vehicle may not remain available throughout your ownership of the vehicle.
- Review all terms and conditions, including all privacy policies, for any applications you access via SUBARU STARLINK. SUBARU CORPORATION is not responsible for any third party applications, including their use of data, their performance, or any other matter.
- SUBARU CORPORATION is not responsible for any charges, including any data charges from your carrier, resulting from your use of any application.
- SUBARU STARLINK may not be able to be used when connecting to an external Wi-Fi® source from this system if the source IP address is 192.168.1.x.

DISPLAYING SUBARU STARLINK INFORMATION

1. Run the SUBARU STARLINK application on your smartphone.
2. Connect the iPhone to the USB port, or connect your iPhone or Android device by utilizing the Bluetooth connection.
 - For details on connecting your iPhone to the USB port: →P.69
For details on registering or connecting your iPhone or Android device: →P.80
3. Select **SUBARU STARLINK** (SUBARU STARLINK) on the Apps screen. (→P.29, 60)

NOTE

- There may be times when **SUBARU STARLINK** (SUBARU STARLINK) does not appear immediately when the ignition switch is set in the "ACC" or "ON" position. If so, please wait.

ABOUT THE SUPPORTED DEVICES

This system supports the following devices.

- iPhone: iOS 15.1 or later
- Android device: Android 11.0 or later

NOTE

- To ensure normal operation, updating your smartphone operating system to the latest version is recommended.

LEGAL NOTICE

► For iPhone

- Caution
For your safety, do not attempt to operate any feature of this device unless it is safe to do so without distraction from safe driving. This device is informational only. Check and abide by your local laws and always obey safe driving rules, and posted signs and signals. Operate this device only in locales in which it is legal. Read the instruction manual for proper operation of this device. This product uses the Smart Phone's data plan for features and services. Please consult carrier data plan usage, pricing, data overage charges, limitations and usage guidelines.
- Permission
You may be asked to provide your personal and/or non-personal information solely for the purpose specified.

- Warranty Disclaimer

Any use of this product (the “Product”), the SUBARU STARLINK software, and any applications that are supported with the Product (collectively with the Product and the SUBARU STARLINK software, the “Product System”), including any reliance upon any of the content displayed by the Product System, shall be at your sole risk. SUBARU CORPORATION and its subsidiaries (“SUBARU CORPORATION”) disclaims any and all responsibility or liability for the accuracy, content, completeness, legality, reliability, or operability or availability of any information from the use of the Product System. The telecommunication network used and the particular version of the iPhone, Android or other smart phone (each, a “Smart Phone”) and the related Apple iOS, Android OS or other smart phone OS (collectively, the Smart Phone and the OS, the “Phone System”) used are the responsibility of the customer, and SUBARU CORPORATION shall have no responsibility for the interoperability of the Product System with any telecommunications network/Phone System combination not explicitly supported by SUBARU CORPORATION in written documentation of the Product System.

The user’s sole and exclusive remedies for any app downloaded from the iTunes Store, Google Play or other application stores (each, an “Application Store”) (including the SUBARU STARLINK app), or otherwise installed on customer’s Smart Phone, shall be as provided in the Application Store Terms and Conditions or other similar document and SUBARU CORPORATION assumes no responsibility for those apps or their operation. Any services provided by the Product System shall be covered by a separate Services Agreement.

TO THE FULLEST EXTENT PERMITTED UNDER APPLICABLE LAW, THE PRODUCT SYSTEM IS PROVIDED "AS IS" AND "AS AVAILABLE," WITHOUT WARRANTY OF ANY KIND, EITHER EXPRESS OR IMPLIED OR STATUTORY, INCLUDING THE IMPLIED WARRANTIES OF MERCHANTABILITY, FITNESS FOR A PARTICULAR PURPOSE, OR NON-INFRINGEMENT. SUBARU CORPORATION AND ITS AFFILIATES, OFFICERS, EMPLOYEES, AGENTS, PARTNERS, SUPPLIERS AND LICENSORS (COLLECTIVELY, "SUBARU CORPORATION PARTIES") DISCLAIM ANY AND ALL WARRANTIES REGARDING THE SECURITY, RELIABILITY, TIMELINESS, COMPLETENESS, ACCURACY AND PERFORMANCE OF THE PRODUCT SYSTEM. SUBARU CORPORATION PARTIES DO NOT WARRANT OR COVENANT THAT ANY DEFECTS OR ERRORS ASSOCIATED WITH THE PRODUCT SYSTEM WILL BE CORRECTED, OR THAT THE PRODUCT SYSTEM IS FREE OF VIRUSES, ERRORS, OR OTHER HARMFUL COMPONENTS, OR WILL OPERATE UNINTERRUPTED OR ON ANY SCHEDULE. BECAUSE SOME JURISDICTIONS DO NOT ALLOW THE EXCLUSION OF IMPLIED WARRANTIES, THE ABOVE EXCLUSION OF IMPLIED WARRANTIES MAY NOT APPLY TO YOU.

► For Android devices

- Caution
For your safety, do not attempt to operate any feature of this device unless it is safe to do so without distraction from safe driving. This device is informational only. Check and abide by your local laws and always obey safe driving rules, and posted signs and signals. Operate this device only in locales in which it is legal. Read the instruction manual for proper operation of this device. This product uses the Smart Phone's data plan for features and services. Please consult carrier data plan usage, pricing, data overage charges, limitations and usage guidelines.
- Permission
You may be asked to provide your personal and/or non-personal information solely for the purpose specified.

- Warranty Disclaimer

Any use of this product (the “Product”), the SUBARU STARLINK software, and any applications that are supported with the Product (collectively with the Product and the SUBARU STARLINK software, the “Product System”), including any reliance upon any of the content displayed by the Product System, shall be at your sole risk. SUBARU CORPORATION and its subsidiaries (“SUBARU CORPORATION”) disclaims any and all responsibility or liability for the accuracy, content, completeness, legality, reliability, or operability or availability of any information from the use of the Product System. The telecommunication network used and the particular version of the iPhone, Android or other smart phone (each, a “Smart Phone”) and the related Apple iOS, Android OS or other smart phone OS (collectively, the Smart Phone and the OS, the “Phone System”) used are the responsibility of the customer, and SUBARU CORPORATION shall have no responsibility for the interoperability of the Product System with any telecommunications network/Phone System combination not explicitly supported by SUBARU CORPORATION in written documentation of the Product System.

The user’s sole and exclusive remedies for any app downloaded from the iTunes Store, Google Play or other application stores (each, an “Application Store”) (including the SUBARU STARLINK app), or otherwise installed on customer’s Smart Phone, shall be as provided in the Application Store Terms and Conditions or other similar document and SUBARU CORPORATION assumes no responsibility for those apps or their operation. Any services provided by the Product System shall be covered by a separate Services Agreement.

TO THE FULLEST EXTENT PERMITTED UNDER APPLICABLE LAW, THE PRODUCT SYSTEM IS PROVIDED "AS IS" AND "AS AVAILABLE," WITHOUT WARRANTY OF ANY KIND, EITHER EXPRESS OR IMPLIED OR STATUTORY, INCLUDING THE IMPLIED WARRANTIES OF MERCHANTABILITY, FITNESS FOR A PARTICULAR PURPOSE, OR NON-INFRINGEMENT. SUBARU CORPORATION AND ITS AFFILIATES, OFFICERS, EMPLOYEES, AGENTS, PARTNERS, SUPPLIERS AND LICENSORS (COLLECTIVELY, "SUBARU CORPORATION PARTIES") DISCLAIM ANY AND ALL WARRANTIES REGARDING THE SECURITY, RELIABILITY, TIMELINESS, COMPLETENESS, ACCURACY AND PERFORMANCE OF THE PRODUCT SYSTEM. SUBARU CORPORATION PARTIES DO NOT WARRANT OR COVENANT THAT ANY DEFECTS OR ERRORS ASSOCIATED WITH THE PRODUCT SYSTEM WILL BE CORRECTED, OR THAT THE PRODUCT SYSTEM IS FREE OF VIRUSES, ERRORS, OR OTHER HARMFUL COMPONENTS, OR WILL OPERATE UNINTERRUPTED OR ON ANY SCHEDULE. BECAUSE SOME JURISDICTIONS DO NOT ALLOW THE EXCLUSION OF IMPLIED WARRANTIES, THE ABOVE EXCLUSION OF IMPLIED WARRANTIES MAY NOT APPLY TO YOU.

Apple CarPlay

Apple CarPlay

Apple CarPlay can be used to view Apple Maps, play music, and place calls by connecting an Apple CarPlay device to the system. Supported applications can also be run.

- For details on the services or the operations, check the Apple CarPlay site (<https://www.apple.com/ios/carplay/>).

► 11.6-inch display system/11.6-inch display with Navi system

To enable the use of the Apple CarPlay application on the vehicle system, register a device compatible with Apple CarPlay to the vehicle system and connect them wirelessly.

► Dual 7.0-inch display system

To use the Apple CarPlay application, connect an Apple CarPlay device to the USB port.

When using the application, read the precautions indicated in "BEFORE USING APPLICATIONS". (→P.124)

⚠ WARNING

- This system is fitted with Wi-Fi® antennas. People with implantable cardiac pacemakers, cardiac resynchronization therapy-pacemakers or implantable cardioverter defibrillators should maintain a reasonable distance between themselves and the Wi-Fi® antennas. The radio waves may affect the operation of such devices.
- Before using Wi-Fi® devices, users of any electrical medical device other than implantable cardiac pacemakers, cardiac resynchronization therapy-pacemakers or implantable cardioverter defibrillators should consult the manufacturer of the device for information about its operation under the influence of radio waves.

Radio waves could have unexpected effects on the operation of such medical devices.

NOTE

- Use an undamaged genuine USB cable when using this function. (Dual 7.0-inch display system only)
- Enable Apple CarPlay in the Apple CarPlay device's restriction settings before using this function.

CONNECTING THE Apple CarPlay DEVICE

► 11.6-inch display system/11.6-inch display with Navi system

1. Connect a device compatible with Apple CarPlay. (→P.87)
2. Check the confirmation message, and then select **Yes** (Yes).
 - The Apple CarPlay screen will be displayed.
 - If **No** (No) is selected, Apple CarPlay will not start. When connected to a USB port, the device will be recognized as an iPod/iPhone. (→P.170) When not connected to a USB port, the device will be recognized as a Bluetooth device. (→P.173)

► Dual 7.0-inch display system

1. Connect a device compatible with Apple CarPlay. (→P.69)
2. Check the confirmation message, and then select **Yes** (Yes).
 - The Apple CarPlay screen will be displayed.
 - If **No** (No) is selected, Apple CarPlay will not start, and the device will be recognized as an iPod/iPhone. (→P.170)
 - If “Don’t show again.” is selected, the confirmation message will not be displayed again.
If the connected device cannot be used as an Apple CarPlay device, change the Apple CarPlay device connection settings. (→P.136)

OVERVIEW

Select **Apple CarPlay** (Apple CarPlay) on the home screen or the apps screen (→P.19, 20, 43, 44) to display the Apple CarPlay screen.

► Control screen*

► 11.6-inch display system/11.6-inch display with Navi system

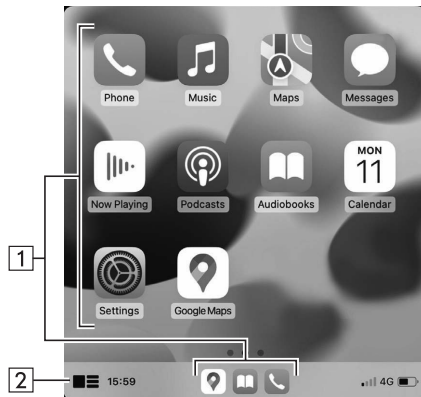

► Dual 7.0-inch display system

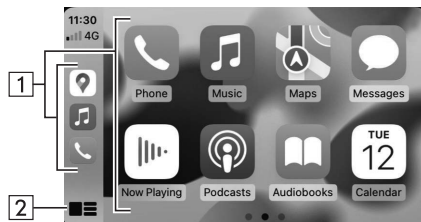

*: The displayed screen will differ depending on the connected Apple CarPlay device.

1

Displays the application buttons.
Select to start the application.

2

Select to change the home screen of Apple CarPlay.

ABOUT THE SUPPORTED DEVICES

This system compatible with iOS 15.1 or later are supported.

ENABLING Apple CarPlay

► 11.6-inch display system/11.6-inch display with Navi system only

1. Select .
2. Select a device to be used for Apple CarPlay from the device list.
3. Select Apple CarPlay from the connection preference list to enable it.

SELECTING DEVICE TO CONNECT TO Apple CarPlay

► Dual 7.0-inch display system only

This setting can be changed only if “Don’t show again.” was selected on the confirmation message displayed when an Apple CarPlay device was connected.

1. Display the phone settings screen. (→P.83)
2. Select **Apple CarPlay** (Apple CarPlay).
3. → **Device List** (Device List)
4. → **Edit** (Edit)
5. Touch the desired device compatible with Apple CarPlay to connect/disconnect it.
6. → **OK** (OK)

DISABLING Apple CarPlay

► 11.6-inch display system/11.6-inch display with Navi system only

1. Select .
2. Select the desired device used for Apple CarPlay from the device list.
3. Select Apple CarPlay from the connection preference list to disable it.

DELETING THE Apple CarPlay DEVICE

► Dual 7.0-inch display system only

This setting can be changed only if “Don’t show again.” was selected on the confirmation message displayed when an Apple CarPlay device was connected.

1. Display the phone settings screen. (→P.83)
2. Select **Apple CarPlay** (Apple CarPlay).
3. → **Device List** (Device List)
4. → **Edit** (Edit)
5. Select  next to the desired device name.
6. → **Yes** (Yes)
7. → **OK** (OK)

Android Auto

Android Auto

Android Auto can be used to view Google Maps, play music, and place calls by connecting an Android Auto device to the system. Supported applications can also be run.

- For details on the services or the operations, check the Android Auto site (<https://www.android.com/auto/>) and (<https://support.google.com/androidauto/>).

► 11.6-inch display system/11.6-inch display with Navi system

The Android Auto application can be used in either of the following methods:

- **Register a device compatible with Android Auto to the vehicle system then connect it wirelessly.**
- **Connect a device compatible with Android Auto to a USB port.**

► Dual 7.0-inch display system

To use the Android Auto application, connect your Android Auto device to the USB port.

When using the application, read the precautions indicated in "BEFORE USING APPLICATIONS". (→P.124)

WARNING

- This system is fitted with Wi-Fi® antennas. People with implantable cardiac pacemakers, cardiac resynchronization therapy-pacemakers or implantable cardioverter defibrillators should maintain a reasonable distance between themselves and the Wi-Fi® antennas. The radio waves may affect the operation of such devices.
- Before using Wi-Fi® devices, users of any electrical medical device other than implantable cardiac pacemakers, cardiac resynchronization therapy-pacemakers or implantable cardioverter defibrillators should consult the manufacturer of the device for information about its operation under the influence of radio waves.

Radio waves could have unexpected effects on the operation of such medical devices.

NOTE

- Use an undamaged genuine USB cable when connecting to a USB port to use Android Auto.
- To use this function, check to make sure that your Android Auto device is set to accept connection with a new vehicle.
- Depending on the model, the talkback volume of the voice recognition function of Android Auto may differ from the volume setting of other functions. Set the volume to a level that is easy to hear.

CONNECTING AN Android Auto DEVICE

► 11.6-inch display system/11.6-inch display with Navi system

1. Connect a device compatible with Android Auto. (→P.69, 87)
2. Check the confirmation message, and then select **Yes** (Yes).
 - The Android Auto screen will be displayed.
 - If **No** (No) is selected, Android Auto will not start.

► Dual 7.0-inch display system

1. Connect a device compatible with Android Auto. (→P.69)
2. Check the confirmation message, and then select **Yes** (Yes).
 - The Android Auto screen will be displayed.
 - If **No** (No) is selected, Android Auto will not start.
 - If “Don’t show again.” is selected, the confirmation message will not be displayed again.
If the connected device cannot be used as an Android Auto device, change the Android Auto device connection settings. (→P.140)

OVERVIEW

Select **Android Auto** (Android Auto) on the home screen or the apps screen (→P.19, 20, 43, 44) to display the Android Auto screen.

► **Control screen***

► **11.6-inch display system/11.6-inch display with Navi system**



1 Displays the application buttons.
Select to start the application.

ABOUT THE SUPPORTED DEVICES

This system compatible with Android 11.0 or later are supported.

► **Dual 7.0-inch display system**

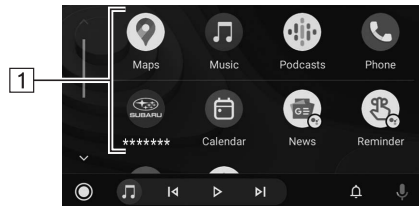

*: The displayed screen will differ depending on the connected Android Auto device.

ENABLING Android Auto

► 11.6-inch display system/11.6-inch display with Navi system only

1. Select .
2. Select a device to be used for Android Auto from the device list.
3. Select Android Auto from the connection preference list to enable it.

SELECTING Android Auto DEVICES TO CONNECT TO Android Auto

► Dual 7.0-inch display system only

This setting can be changed only if “Don’t show again.” was selected on the confirmation message displayed when an Android Auto device was connected.

1. Display the phone settings screen. (→P.83)
2. Select **Android Auto** (Android Auto).
3. → **Device List** (Device List)
4. → **Edit** (Edit)
5. Select  for the desired Android Auto device.

DISABLING Android Auto

► 11.6-inch display system/11.6-inch display with Navi system only

1. Select .
2. Select the desired device used for Android Auto from the device list.
3. Select Android Auto from the connection preference list to disable it.

DELETING THE Android Auto DEVICE

► Dual 7.0-inch display system only

This setting can be changed only if “Don’t show again.” was selected on the confirmation message displayed when an Android Auto device was connected.

1. Display the phone settings screen. (→P.83)
2. Select **Android Auto** (Android Auto).
3. → **Device List** (Device List)
4. → **Edit** (Edit)
5. Select  next to the desired device name.
6. → **Yes** (Yes)
7. → **OK** (OK)

SiriusXM Travel Link

SiriusXM Travel Link*

*: SiriusXM U.S. satellite and data services are available only in the 48 contiguous USA and DC. SiriusXM satellite service is also available in Canada; see www.siriusxm.ca.

Data service information, which is comprised of sports information, weather information, stock information, parking information and fuel information, can be received via the SiriusXM® Radio.

To receive the data service information in the vehicle, a subscription to the SiriusXM® Radio Service is necessary following a free trial. (→P.165)

Content that uses the SiriusXM® Radio Service is reset when personal information is initialized by selecting **Factory Data Reset** (Factory Data Reset) at the "GENERAL SETTINGS SCREEN". (→P.92)

NOTE

- Information available on the SiriusXM Travel Link services can be registered, within limited numbers.

DISPLAYING SPORTS INFORMATION

Sports information such as games and results, the status of games still in progress, and future game schedules can be displayed.

1. Select **Travel Link** (Travel Link) on the Apps screen. (→P.29, 60)
2. → **Sports** (Sports)

3. Check that sports information is displayed.

► **11.6-inch display system/11.6-inch display with Navi system**

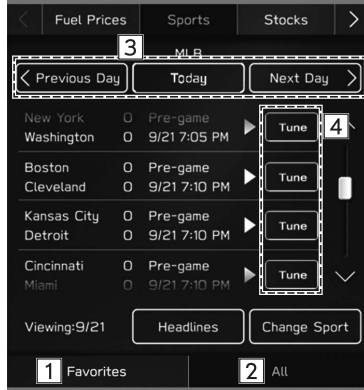

► **Dual 7.0-inch display system**



1	Select to display the favorite teams information. Favorite Team (Favorite Team): Select to register, edit or select your favorite team.
2	Select to display all information for a selected sport. Headlines (Headlines): Select to display the headlines. Change Sport (Change Sport): Select to change the sport.
3	Select to change the displayed information.
4	Select to listen to a broadcast.

DISPLAYING WEATHER INFORMATION

Weather forecasts, forecast temperature or highest/lowest temperature, and the chances of precipitation, etc. can be displayed in weather information.

1. Select **Travel Link** (Travel Link) on the Apps screen. (→P.29, 60)
2. → **Weather** (Weather)

3. Check that weather information is displayed.

► 11.6-inch display system/11.6-inch display with Navi system

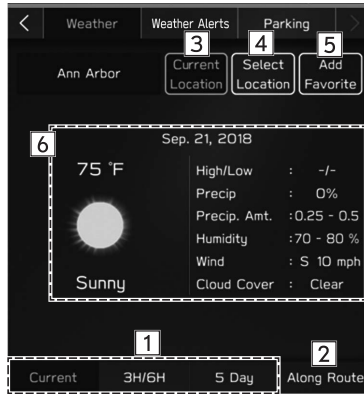

► Dual 7.0-inch display system

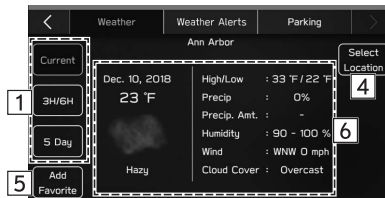

1	Select to switch the timing of the displayed forecast.
2 *	Select to display the weather forecast for the route being travelled during route guidance.
3 *	Select to display the weather forecast from your current location to your destination.
4	Select to change the region which information will be displayed. The region can be selected from registered favorites or a full list of regions.
5	Select to add the currently displayed location as a favorite.
6	Weather information is displayed.

*: 11.6-inch display with Navi system only

DISPLAYING WEATHER ALERTS

Weather alerts can be displayed.

1. Select **Travel Link** (Travel Link) on the Apps screen. (→P.29, 60)
2. → **Weather Alerts** (Weather Alerts)

3. Check that weather alerts are displayed.
 - ▶ **11.6-inch display system/11.6-inch display with Navi system**



- ▶ **Dual 7.0-inch display system**



1	Select to sort weather alerts by priority.
2	Select to sort weather alerts by distance.
3*	Select to display the weather alerts from your current location to your destination.
4	Select to change the region which information will be displayed. The region can be selected from registered favorites or a full list of regions.
5	Select to add the favorite regions list.
6	Select to set the alert types, zone and notifications.
7	Weather alerts are displayed.

*: 11.6-inch display with Navi system only

DISPLAYING STOCKS INFORMATION

Company names, stock prices, and price fluctuations can be displayed in stock information. Fluctuations greater than zero are displayed with green arrows, and fluctuations less than zero are displayed with red arrows.

1. Select **Travel Link** (Travel Link) on the Apps screen. (→P.29, 60)
2. → **Stocks** (Stocks)

3. Check that stock information is displayed.

► 11.6-inch display system/11.6-inch display with Navi system

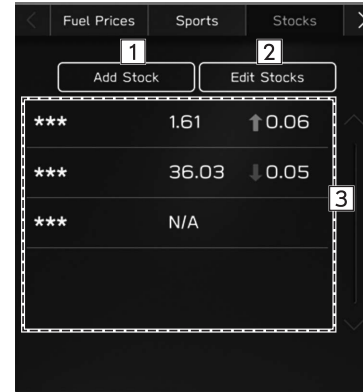

► Dual 7.0-inch display system



1	Select to add stocks.
2	Select to delete stocks.
3	Stock information is displayed.

DISPLAYING FUEL INFORMATION

Gas station information can be displayed, and gas stations can be set* as the destination. When Bluetooth is enabled on your cellular phone, calls can be placed if the displayed information screen contains phone number information.

*: 11.6-inch display with Navi system only

1. Select **Travel Link** (Travel Link) on the Apps screen. (→P.29, 60)
2. → **Fuel Prices** (Fuel Prices)

3. Check that fuel information is displayed.
 - ▶ **11.6-inch display system/11.6-inch display with Navi system**



- ▶ **Dual 7.0-inch display system**



1 *1	Select to sort the display order of gas stations by distance from the current position.
2 *2	Select to sort the display order of gas stations by price.
3	Select to sort the display order of gas stations by brand.
4	Select to change the location for which fuel information is displayed.
5	Select to set the fuel type.
6	Select to change the country which information will be displayed.
7 *1	Select to update the gas station information.
8	Select to display information about a gas station and be able to add it to favorites.
9	Select to display the favorite gas stations list.
10 *1	Select to display the currently displayed gas stations on the map.

*1: 11.6-inch display with Navi system only

*2: Not available when "US & CAN" is selected for countries for which information is displayed

DISPLAYING PARKING INFORMATION

Parking information can be displayed, and parking can be set* as the destination. When Bluetooth is enabled on your cellular phone, calls can be placed if the displayed information screen contains phone number information.

*: 11.6-inch display with Navi system only

1. Select **Travel Link** (Travel Link) on the Apps screen. (→P.29, 60)
2. → **Parking** (Parking)

3. Check that parking information is displayed.

► 11.6-inch display system/11.6-inch display with Navi system



► Dual 7.0-inch display system



1	Select to change the region which information will be displayed.
2 *	Select to update the parking information.
3	Select to display information about a parking lot and be able to add it to favorites.
4 *	Select to display the currently displayed parking lots on the map.
5	Select to sort parking lots by price per day.
6	Select to sort parking lots by price per hour.
7 *	Select to sort the display order of parking lots by distance from the current position.
8	Select to display the favorite parking lots list.

*: 11.6-inch display with Navi system only

6 Audio



Basic Operation 150

Some Basics	150
Turning The System On And Off	150
Selecting An Audio Source	151
Sound Settings	153
Voice Recognition System	156

Radio Operation 157

AM/FM Radio	157
Overview	157
Registering A Station As A Preset	158
Selecting A Station From The List	158
Radio Broadcast Data System	159
Available HD Radio™ Technology	159
Caching Radio Programs	161

SiriusXM® Radio	163
Overview	163
How To Subscribe To SiriusXM®	165
Displaying The Radio ID	167
Presetting A Channel	167

Media Operation 168

USB Memory	168
Overview	168
iPod/iPhone	170
Connecting The iPod/iPhone	170
Overview	170
Bluetooth Audio	173
Overview	173
Connecting A Bluetooth Device	176
AUX	177
Overview	177

Apple CarPlay	178
Connecting An Apple CarPlay Device	178
Overview	179
Android Auto	181
Connecting An Android Auto Device	181
Overview	181

Audio Remote Controls 184

Steering Wheel Controls	184
--------------------------------------	-----

Tips For Operating The Audio System 186

Operating Information	186
Radio	186
USB Memory Device	188
iPod/iPhone	188
File Information	188

BASIC OPERATION

SOME BASICS

This section describes some of the basic features of the audio system. Some information may not pertain to your system.

Your audio system works when the ignition switch is turned to the "ACC" or "ON" position.

 **CAUTION**



- To prevent the battery from being discharged, do not leave the audio system on longer than necessary when the engine is not running.

TURNING THE SYSTEM ON AND OFF



"VOLUME" knob: Press and hold until a message is displayed, wait a few seconds for the audio system to turn off.



To turn the audio system on, press and hold the knob again or perform the following:

- 11.6-inch display system/11.6-inch display with Navi system: Touch the screen to display  and select it.
- Dual 7.0-inch display system: Press .

The system will turn on with the last audio source used. Turn this knob to adjust the volume.

Press to turn the volume mute on/off.

► **Dual 7.0-inch display system only**

 : Press to display screen buttons for the audio system.

NOTE

- The audio system will remain off if you change the position of the ignition switch from "LOCK"/"OFF" to "ACC"/"ON" while the audio system is off. If you had set the volume to mute, the audio system will remain mute and the track will start playing from where it was last stopped.

SELECTING AN AUDIO SOURCE**▶ 11.6-inch display system/11.6-inch display with Navi system**

1. Display the home screen. (→P.43)
2. Select **Radio** (Radio) or **Media** (Media).
3. Select the desired audio source.

**<Radio screen>**

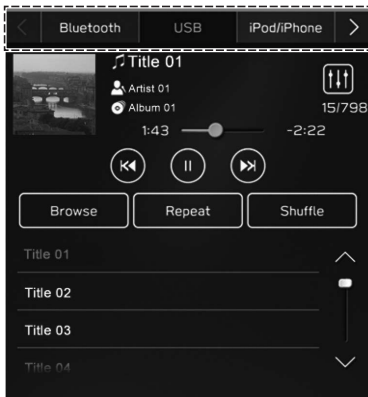

<Media screen>

► Dual 7.0-inch display system

1. Press **RADIO** or **MEDIA**.
2. Select the desired audio source.



<Radio screen>

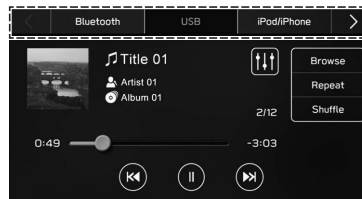

<Media screen>

- Each time **RADIO** or **MEDIA** is pressed, the audio source can also be changed.

SOUND SETTINGS

DISPLAYING THE SOUND CUSTOMIZATION SCREEN

1. Display the home screen. (→P.19, 43)
2. Select **Settings** (Settings).
3. → **Sound** (Sound)
4. → **Audio** (Audio)
5. → **Sound Customization** (Sound Customization)

EQUALIZER SETTINGS

How good an audio program sounds is largely determined by the mix of the treble, mid and bass levels. In fact, different kinds of music and vocal programs usually sound better with different mixes of treble, mid and bass.

1. Display the “Sound Customization” screen. (→P.153)
2. Select **Equalizer** (Equalizer).

3. Set the desired item.

▶ 11.6-inch display system/11.6-inch display with Navi system

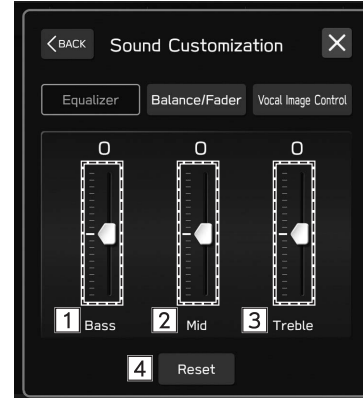

▶ Dual 7.0-inch display system

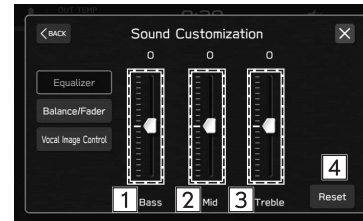

1	Select the sliders to adjust low-pitched tones.
2	Select the sliders to adjust mid-pitched tones.
3	Select the sliders to adjust high-pitched tones.
4	Select to reset all setup items.

BALANCE/FADER SETTINGS

A good balance of the left and right stereo channels and of the front and rear sound levels is also important.

Keep in mind that when listening to a stereo recording or broadcast, changing the right/left balance will increase the volume of 1 group of sounds while decreasing the volume of another.

1. Display the "Sound Customization" screen. (→P.153)
2. Select **Balance/Fader** (Balance/Fader).

3. Adjust to the desired position.

▶ 11.6-inch display system/11.6-inch display with Navi system

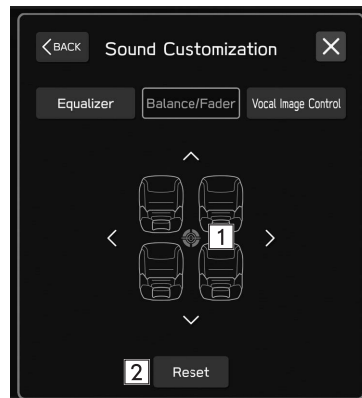

▶ Dual 7.0-inch display system

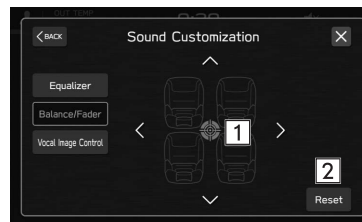

1	Select the icon to adjust sound balance.
2	Select to reset the adjusted position.

VOCAL IMAGE CONTROL SETTINGS*

*: This setting can be made depending on the connected amplifier type.

Extract only vocal sound from whole sound and adjust volume balance of it.

1. Display the "Sound Customization" screen. (→P.153)
2. Select **Vocal Image Control** (Vocal Image Control).

3. Adjust to the desired position.

▶ 11.6-inch display system/11.6-inch display with Navi system

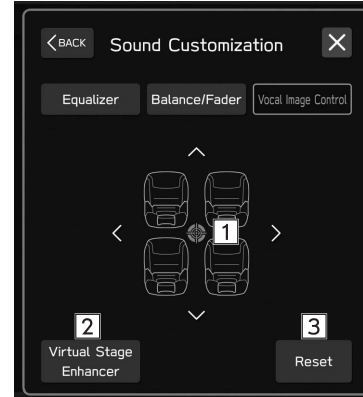

▶ Dual 7.0-inch display system

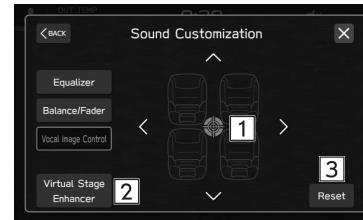

1	Select the icon to adjust vocal image control.
2	Select to set the virtual stage enhancer function. This function adjusts the sounds to the high realistic surround sound by enhancing the vocals. When this setting is on, the front and rear setting of "Vocal Image Control" cannot be set.
3	Select to reset the vocal image control settings.

VOICE RECOGNITION SYSTEM

1. Press this switch to operate the voice recognition system.

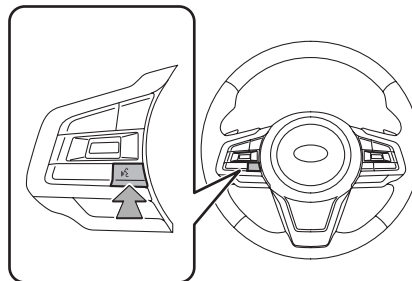

- The voice recognition system and its list of commands can be operated. (→P.226)

RADIO OPERATION

AM/FM RADIO

OVERVIEW

The FM/AM radio operation screen can be accessed by selecting **FM** (FM) or **AM** (AM) on the radio control screen. (→P.151)

▶ Control panel



1	Turn to adjust the volume. Press to mute the audio system. Press and hold to turn the audio system off, and press and hold to turn it on again.
2	Turn to step up/down frequencies. Press and hold to display the sound customization screen. (→P.153)

▶ Control screen

▶ 11.6-inch display system/11.6-inch display with Navi system

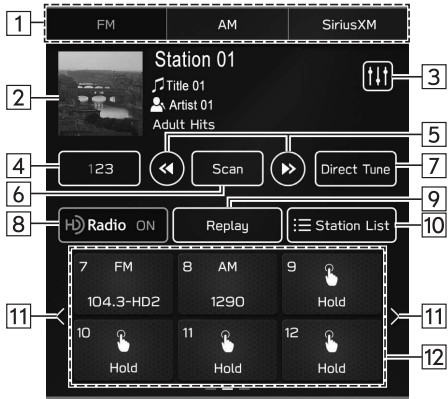

▶ Dual 7.0-inch display system

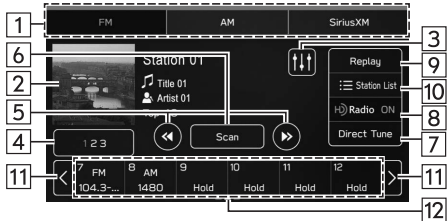

1	Select to change radio modes.
2	Press and hold to save a specific song to your Bookmark List. (→P.100)
3	Select to display the sound customization screen. (→P.153)
4 *	Select to change multicast channels available. (→P.160)
5	Select to step up/down frequencies. Select and hold to seek frequencies.
6	Select to scan for receivable stations/channels. The scan will continue until selected again.
7	Select to search for stations by entering frequency number.
8	Select to turn HD Radio mode on/off.
9	Select to display the cache radio operation buttons. (→P.161)
10	Select to display a list of receivable stations. (→P.158)
11	Select to scroll the list of preset buttons.
12	Select to tune to preset stations/channels. The preset station list can be scrolled by swiping the list.

*: FM Radio only

NOTE

- The radio automatically changes to stereo reception when a stereo broadcast is received.
- When the HD Radio mode is on, the radio automatically tunes to an HD Radio signal in AM or FM where available.

REGISTERING A STATION AS A PRESET

Multiple stations can be registered as presets.

1. Tune to the desired station.
2. Select and hold one of the desired preset station buttons.
 - To change the preset station to a different one, follow the same procedure.

SELECTING A STATION FROM THE LIST

A station list can be displayed.

1. Select **Station List** (Station List).
 - **Update** (Update): Select to update the station list.
- ▶ **FM Radio only**
 2. Select the desired list.
 - **All** (All): Select to display all stations.
 - **Genres** (Genres): Select to display categories.
 3. Select the desired station.

RADIO BROADCAST DATA SYSTEM

This audio system is equipped with Radio Broadcast Data Systems (RBDS).

RBDS mode allows text messages to be received from radio stations that utilize RBDS transmitters.

RBDS features are available only when listening to an FM station that broadcasts RBDS information.

AVAILABLE HD Radio™ TECHNOLOGY

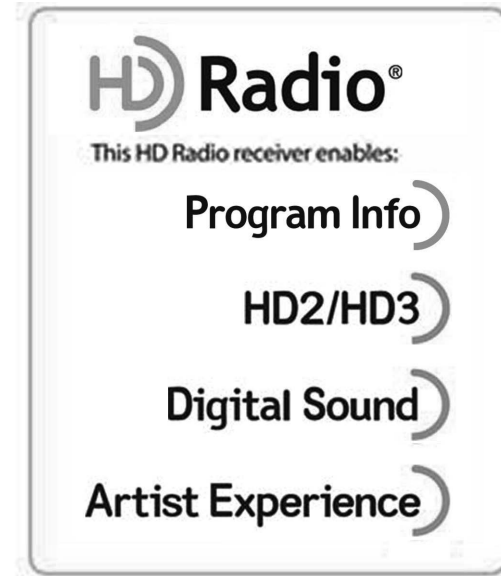

HD Radio Technology manufactured under license from iBiquity Digital Corporation. U.S. and Foreign Patents. For patents see <http://dts.com/patents>. HD Radio, Artist Experience, and the HD, HD Radio, and "ARC" logos are registered trademarks or trademarks of iBiquity Digital Corporation in the United States and/or other countries.

MULTICAST

On the FM radio frequency most digital stations have additional programs on one FM station.

1. Select .
 - Each time  is selected, the channel can be changed.



Digital Sound

- HD Radio™ Technology improves the audio quality of your local stations and delivers a crystal clear digital signal to your receiver. HD Radio Technology enables local radio stations to broadcast a clean digital signal. AM sounds like today's FM and FM sounds like clear digital.

HD2/HD3

- FM stations can provide additional digital-only audio programming on HD2/HD3 Channels.
- EXAMPLE:
 - 101.1 HD1
 - 101.1 HD2
 - 101.1 HD3

NOTE

- HD Radio™ stations can be preset.
- An orange  will be displayed on the screen when in digital. The  will first appear in a gray color indicating the digital station is being acquired. Once the digital signal is acquired, the logo will change to a bright orange color.
- The song title and artist name will appear on the screen when available by the radio station. The radio station can send album pictures when available.
- As a user works through the analog radio stations, (where applicable) the radio receiver will automatically tune from an analog signal to a digital signal within 5 seconds.

Program Info

- Program info provides song name, artist, station ID, and other relevant data to your receiver.

Artist Experience

- Visual images of album cover art and station logos are broadcasted with the audio to your receiver, such as Album Art, historical photographs, still art from live broadcasts, station logos, among other related content.

Live Pause

- Allows HD Radio receivers to store content (songs/programs and data) in a buffer. Playback shall start at any point in the buffer and shall continue until the end of the buffer or until the user has selected to stop playback. Live Pause has the ability to store both analog and digital content in the buffer.

CACHING RADIO PROGRAMS

A radio program can be cached and played back in a time-shifted manner.

AUTOMATIC PLAYBACK OF THE CACHE

If the radio broadcast is interrupted by another audio output, such as an incoming phone call, the system will automatically cache the interrupted portion. To manually operate the cache operation: →P.161

NOTE

- The system can store up to 30 minutes. Cached data will be erased when the radio mode or station is changed or when the audio system is turned off.

PLAYING BACK THE CACHE MANUALLY

The broadcast cached in the program cache can be played back manually.

1. Select **Replay** (Replay). (→P.157)

2. Select the desired cache radio operation button.

► **11.6-inch display system/11.6-inch display with Navi system**

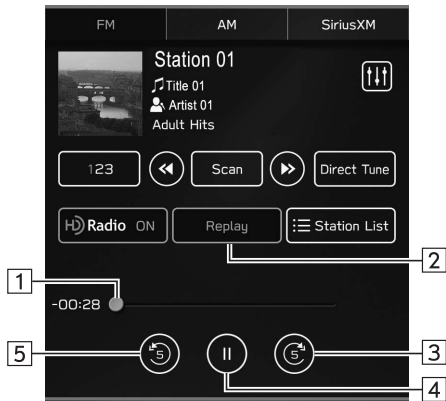

► **Dual 7.0-inch display system**



1	Shows the current playback location. The playback location can be changed by dragging the sliders.
2	Select to display the preset stations/channels. (→P.157)
3	Select: Skips forward 5 seconds. Select and hold: Fast forwards continuously.
4	Pauses or plays the radio broadcast.
5	Select: Skips backward 5 seconds. Select and hold: Fast rewinds continuously.

NOTE

● The time displayed on the bar scale may differ from the actual time.

SiriusXM® Radio

OVERVIEW

The SiriusXM® control screen can be accessed by selecting **SiriusXM** (SiriusXM) on the radio control screen. (→P.151)

▶ Control panel



1	Turn to adjust the volume. Press to mute the audio system. Press and hold to turn the audio system off, and press and hold to turn it on again.
2	Turn to step up/down channels. Press and hold to display the sound customization screen. (→P.153)

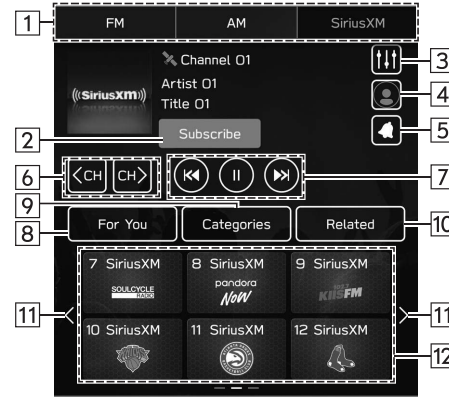

▶ Control screen

▶ 11.6-inch display system/11.6-inch display with Navi system

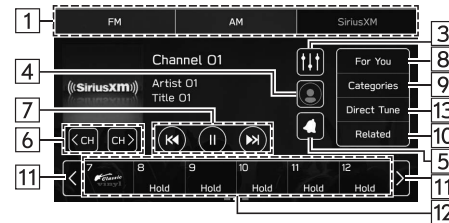

▶ Dual 7.0-inch display system



1	Select to change radio modes.
2 *1	Select to display the phone number of SiriusXM® customer care and your radio ID. <ul style="list-style-type: none"> • Call (Call): Select to make a call when a Bluetooth-compatible phone is connected.
3	Select to display the sound customization screen. (→P.153)
4	Select to display the SiriusXM® radio setting screen. (→P.101)
5 *2	Select to enable/disable notification of registered sports teams or music artists/tunes, such as their game match starting time or tune to be played.
6	Select to display currently available channels and select a channel. Can be swiped for a tune. <ul style="list-style-type: none"> • Direct Tune (Direct Tune): The channel list screen can be changed to channel number entering screen to search a channel.
7 *2	Select to operate previous content of the currently selected channel that is cached in the vehicle system. <ul style="list-style-type: none"> • : Select to skip back the cached content. • : Select to pause/release pause of the cached content playback. • : Select to skip forward the cached content until "LIVE" is displayed. Dual 7.0-inch display system only: <ul style="list-style-type: none"> • Subscribe (Subscribe)*1: Select to display the phone number of SiriusXM® customer care and your radio ID.

8	Select to display a list of contents recommended to the user.
9	Select to display a channel list by category.
10 *3	Select to display a list of contents related to the current content you are listening to.
11	Select to scroll the list of preset buttons.
12	Select to tune to preset channels. The preset channel list can be scrolled by swiping the list.
13 *4	Select to search channels by entering the channel number.

*1: Displayed before subscribing to SiriusXM® radio

*2: Displayed after subscribing to SiriusXM® radio

*3: Operation is available after subscribing to SiriusXM® radio

*4: Dual 7.0-inch display system only

HOW TO SUBSCRIBE TO SiriusXM®

To listen to a SiriusXM broadcast in the vehicle, a subscription to SiriusXM is required following any trial included with the purchase of your vehicle.

SiriusXM is only available in the U.S. and Canada.

HOW TO SUBSCRIBE

SiriusXM audio and infotainment services provided by Sirius XM Radio Inc.

Trial Subscription Details: Your SiriusXM trial subscription will automatically stop at the end of your trial period. If you decide to purchase a subscription plan after your trial, your service will automatically renew in accordance with your selected plan and you will be charged according to your chosen payment method at the then-current rates, plus applicable fees and taxes. Services are subject to the SiriusXM Customer Agreement and Privacy Policy available at siriusxm.com (if in Canada, Siriusxm.ca) which includes complete terms and how to cancel. All fees, content and features are subject to change.

- For more information on your SiriusXM service or to subscribe please refer to the following:

► U.S.A.

Refer to www.siriusxm.com or call

To Subscribe: 1-877-447-0011.

To Cancel: 1-866-635-2349.

► Canada

Refer to www.siriusxm.ca or call

To Subscribe/Cancel: 1-877-209-0079.

⚠ WARNING

- Explicit Language Notice — Channels with frequent explicit language are indicated with an “XL” preceding the channel name. Channel blocking is available for SiriusXM® Radio receivers by notifying SiriusXM at;

U.S.A. Customers:

Visit www.siriusxm.com or calling

1-877-447-0011

Canadian Customers:

Visit www.siriusxm.ca or calling

1-877-209-0079

⚠ CAUTION

- It is prohibited to copy, decompile, disassemble, reverse engineer, hack, manipulate, or otherwise make available any technology or software incorporated in receivers compatible with the SiriusXM® Radio Services or that support the SiriusXM website, the Streaming Service or any of its content. Furthermore, the AMBE® voice compression software included in this product is protected by intellectual property rights including patent rights, copyrights, and trade secrets of Digital Voice Systems, Inc.
- Note: this applies to SiriusXM® Radio receivers only and not SiriusXM Ready devices.

NOTE

- About SiriusXM Trial Subscription
ABOUT

The SiriusXM Platinum Plan is the ultimate entertainment experience, featuring expertly curated ad-free music and exclusive artist created music channels, premium sports coverage with live play-by-play from every major sport, and sports talk including all of our official league and college conference channels. It also includes exclusive comedy, talk and news. Discover even more when you stream on the SXM App, with Xtra music channels for any mood or activity, podcasts including SiriusXM originals, all included with your trial.

SiriusXM also delivers a wide variety of services such as Traffic, Weather, Sports Scores, Movie Listings, Fuel Prices, Stock Prices to navigation equipped vehicles. For a list of available features in your vehicle, visit siriusxm.com/infotainment and get the most out of your driving experience.

RADIO OPERATION

Look for the Sirius, XM, SXM, Band, SAT, AUX, Radio or Source button and you're in.

If you can't hear us, it's easy to get started:

- Locate your Radio ID/ESN by turning to Channel 0. If you don't see your number there, go to Siriusxm.com/activationhelp to find it.
- Visit siriusxm.com/refresh or call 1-855-MYREFRESH (697-3373) to send a refresh signal to your radio.

Canadian Customers:

- Locate your Radio ID/ESN by turning to Channel 0.
- Visit siriusxm.ca/refresh to send a refresh signal to your radio or call 1-888-539-7474 for service.

DISPLAYING THE RADIO ID

Each SiriusXM tuner is identified with a unique radio ID which is 8 alphanumeric characters. The radio ID is required when activating your SiriusXM radio or when reporting a problem.

1. Select .
2. → **Contact SiriusXM** (Contact SiriusXM)
3. Your radio ID will be displayed.

PRESETTING A CHANNEL

Multiple stations can be registered as presets.

1. Tune to the desired channel.
2. Select and hold one of the desired preset station buttons.
 - To change the preset station to a different one, follow the same procedure.

MEDIA OPERATION

USB MEMORY

Audio files on a USB memory device can be played back.

OVERVIEW

The USB Audio playback screen can be accessed with the following methods:

- Connect a USB memory device. (→P.69)
- Select **USB** (USB) on the media control screen. (→P.151)

▶ Control panel



1	Turn to adjust the volume. Press to mute the audio system. Press and hold to turn the audio system off, and press and hold to turn it on again.
2	Turn to change the track. Press and hold to display the sound customization screen. (→P.153)

▶ Control screen

▶ 11.6-inch display system/11.6-inch display with Navi system

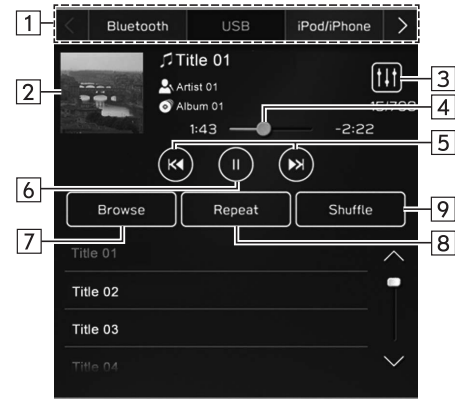

▶ Dual 7.0-inch display system



1	Select to switch between other media sources.
2	Displays cover art.
3	Select to display the sound customization screen. (→P.153)
4	Shows progress. The playback location can be changed by dragging the sliders.
5	Select to change the track. Select and hold to fast forward/rewind.
6	Select to pause/play.
7	Select to search for a track.
8	Changes between repeat current album/folder → repeat current track → cancel repeat each time this button is selected.
9	Select to enable/disable random playback for the tracks currently playing from the USB memory device.

WARNING

- Do not operate the player's controls or connect the USB memory device while driving.

CAUTION

- Do not leave your portable player in the vehicle. In particular, high temperatures inside the vehicle may damage the portable player.
- Do not push down on or apply unnecessary pressure to the portable player while it is connected as this may damage the portable player or its terminal.
- Do not insert foreign objects into the port as this may damage the portable player or its terminal.

NOTE

- Depending on the device or music file being played, the cover art may not be displayed.
- Dual 7.0-inch display system only: If "SUBARU STARLINK Auto Connect" is on, audio files on a connected USB memory device cannot be played back. To playback audio files on a USB memory device, connect the USB memory device after turning "SUBARU STARLINK Auto Connect" off. (→P.92)

iPod/iPhone

When an iPod/iPhone is connected to the USB port, you can play iPod/iPhone music files. On this unit, you can perform operations such as selecting a file from a list or changing to the random playback mode.

CONNECTING THE iPod/iPhone

► 11.6-inch display system/11.6-inch display with Navi system

1. Connect an iPod/iPhone to the USB port. (→P.69)
 - When Apple CarPlay is started, disable Apple CarPlay on the “Manage Devices” screen. (→P.87)

► Dual 7.0-inch display system

1. Connect an iPod/iPhone to the USB port. (→P.69)
2. Check the confirmation message, and then select **No** (No).
 - If “Don’t show again.” is selected, the confirmation message will not be displayed again.
 - If the connected iPhone is recognized as an Apple CarPlay device, select the device from the Apple CarPlay device list to disable the device. (→P.136)

OVERVIEW

Select **iPod/iPhone** (iPod/iPhone) on the media control screen. (→P.151)

► Control panel



1	Turn to adjust the volume. Press to mute the audio system. Press and hold to turn the audio system off, and press and hold to turn it on again.
2	Turn to change the track. Press and hold to display the sound customization screen. (→P.153)

► Control screen

► 11.6-inch display system/11.6-inch display with Navi system

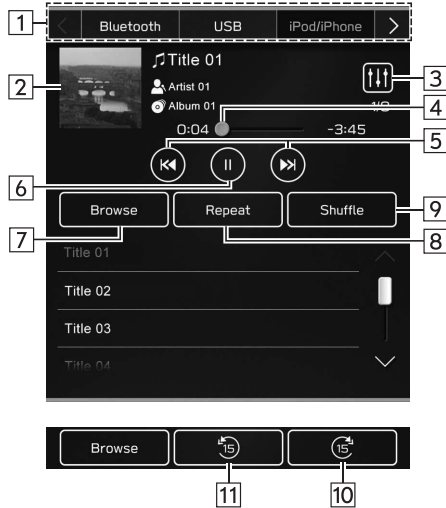

► Dual 7.0-inch display system

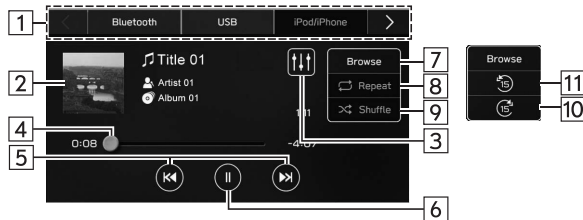

1	Select to switch between other media sources.
2	Displays cover art.
3	Select to display the sound customization screen. (→P.153)
4	Shows progress. The playback location can be changed by dragging the sliders.
5	Select to change the track. Select and hold to fast forward/rewind.
6	Select to pause/play.
7	Select to search for a track.
8	Changes between repeat current album → repeat current track → cancel repeat each time this button is selected.
9	Select to enable/disable random playback for the tracks currently playing on the iPod/iPhone.
10 *	Select to fast forward the current content item in fixed intervals.
11 *	Select to rewind the current content item in fixed intervals.

*: Display when playing Audiobooks or Podcasts

⚠ WARNING

- Do not operate the player's controls or connect the iPod/iPhone while driving.

⚠ CAUTION

- Do not leave your iPod/iPhone in the vehicle. In particular, high temperatures inside the vehicle may damage it.
- Do not push down on or apply unnecessary pressure to the connector area of the iPod/iPhone while it is connected as this may damage the device or its terminals.
- Do not insert foreign objects into the port as this may damage the device or its terminals.

NOTE

- When an iPod/iPhone is connected using an undamaged genuine iPod/iPhone cable, battery of the iPod/iPhone will be charged.
- When playing music on an iPod/iPhone, operate connect it to the system using an undamaged genuine iPod/iPhone cable and operate the iPod/iPhone from the system. Certain functions may not be available if connected using other methods. Furthermore, depending on the connected iPod/iPhone, certain functions may not be available.
- Depending on the iPod/iPhone or music file being played, the cover art may not be displayed.
- When an iPod/iPhone is connected and the audio source is changed to iPod/iPhone mode, the iPod/iPhone will resume playing from the same point it was last used.
- Tracks selected by operating a connected iPod/iPhone may not be recognized or displayed properly.

Bluetooth AUDIO

The Bluetooth audio system enables users to play music files stored on Bluetooth devices through the vehicle speakers via wireless communication.

This audio system supports Bluetooth, a wireless data system capable of playing portable audio music without cables. If your device does not support Bluetooth, the Bluetooth audio system will not function.

OVERVIEW

The Bluetooth audio control screen can be accessed by selecting **Bluetooth** (Bluetooth) on the media control screen. (→P.151)

Depending on the type of portable player connected, some functions may not be available and/or the screen may look differently than shown in this manual.

► Control panel



1	Turn to adjust the volume. Press to mute the audio system. Press and hold to turn the audio system off, and press and hold to turn it on again.
2	Turn to change the track. Press and hold to display the sound customization screen. (→P.153)

► **Control screen**

► **11.6-inch display system/11.6-inch display with Navi system**

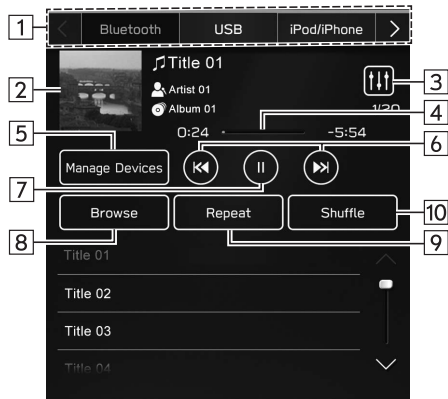

► **Dual 7.0-inch display system**

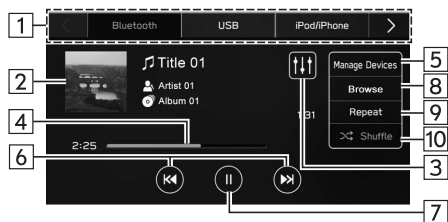

1	Select to switch between other media sources.
2	Displays cover art.
3	Select to display the sound customization screen. (→P.153)
4	Shows progress.
5	Select to display the "Manage Devices" screen. (→P.176)
6	Select to change the track. Select and hold to fast forward/rewind.
7	Select to pause/play.
8	Select to search for a track.
9	Changes between repeat current album/folder → repeat current track → cancel repeat each time this button is selected.
10	Select to enable/disable random playback for the tracks currently playing on the Bluetooth device.



⚠ WARNING

- Do not operate the player's controls or connect to the Bluetooth audio system while driving.
- This system is fitted with Bluetooth antennas. People with implantable cardiac pacemakers, cardiac resynchronization therapy-pacemakers or implantable cardioverter defibrillators should maintain a reasonable distance between themselves and the Bluetooth antennas. The radio waves may affect the operation of such devices.
- Before using Bluetooth devices, users of any electrical medical device other than implantable cardiac pacemakers, cardiac resynchronization therapy-pacemakers or implantable cardioverter defibrillators should consult the manufacturer of the device for information about its operation under the influence of radio waves. Radio waves could have unexpected effects on the operation of such medical devices.

⚠ CAUTION

- Do not leave your portable player in the vehicle. In particular, high temperatures inside the vehicle may damage the portable player.

NOTE

- Depending on the Bluetooth device that is connected to the system, the music may start playing when selecting  while it is paused. Conversely, the music may pause when selecting  while it is playing.
- In the following conditions, the system may not function:
 - The Bluetooth device is turned off.
 - The Bluetooth device is not connected.
 - The Bluetooth device has a low battery.
- It may take time to connect the phone when Bluetooth audio is being played.
- For operating the portable player, see the instruction manual that comes with it.
- If the Bluetooth device is disconnected due to poor reception from the Bluetooth network when the ignition switch is turned to the "ACC" or "ON" position, the system will automatically reconnect to the portable player.
- If the Bluetooth device is disconnected on purpose, such as it was turned off, this does not happen. Reconnect the portable player manually.
- Bluetooth device information is registered when the Bluetooth device is connected to the Bluetooth audio system. When transferring ownership of your vehicle, remove the Bluetooth audio information from the system. (→P.92)
- Depending on the Bluetooth device or music file being played, the cover art may not be displayed.
- If the Bluetooth device does not play automatically when connected, device operation may be necessary.
- Operability of all Bluetooth devices with this system is not guaranteed.

NOTE

- Depending on the Bluetooth device connected, irregularities, such as disabled operation of the audio system, inconsistent display with the connected device, longer time required for audio playback, may result.
- Depending on the music playback application of a Bluetooth device, the Bluetooth audio may not operate properly.
- If the specifications or profile of the connected Bluetooth device is lower than recommended or not compatible, the Bluetooth device may not function properly.
- If a Bluetooth device is enclosed by metal object or in a remote area away from the vehicle's Bluetooth module, sound quality of the playback may be deteriorated or the wireless communication may be severed.

CONNECTING A Bluetooth DEVICE

To use the Bluetooth audio system, it is necessary to register a Bluetooth device with the system.

▶ Registering an additional device

1. Select **Manage Devices** (Manage Devices) on the Bluetooth audio control screen.
2. For more information: →P.84

▶ Selecting a registered device

1. Select **Manage Devices** (Manage Devices) on the Bluetooth audio control screen.
2. Select the Bluetooth device to be connected.

AUX

OVERVIEW

The AUX control screen can be accessed with the following methods:

- Connect a portable audio device. (→P.69)
- Select **AUX** (AUX) on the media control screen. (→P.151)

▶ Control panel



1	Turn to adjust the volume. Press to mute the audio system. Press and hold to turn the audio system off, and press and hold to turn it on again.
2	Press and hold to display the sound customization screen. (→P.153)

▶ Control screen

▶ 11.6-inch display system/11.6-inch display with Navi system

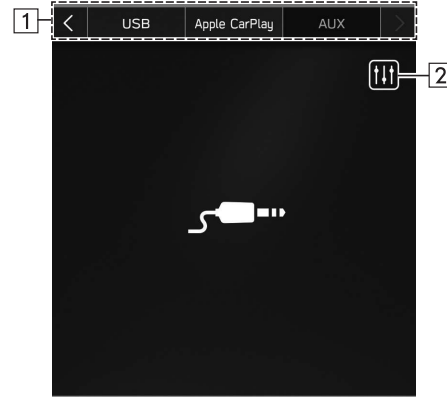

▶ Dual 7.0-inch display system



1	Select to switch between other media sources.
2	Select to display the sound customization screen. (→P.153)

! WARNING

- Do not operate the player's controls or connect the portable audio device while driving.

! CAUTION

- Do not leave portable audio device in the vehicle. The temperature inside the vehicle may become high, resulting in damage to the player.
- Do not push down on or apply unnecessary pressure to the portable audio device while it is connected as this may damage the portable audio device or its terminal.
- Do not insert foreign objects into the port as this may damage the portable audio device or its terminal.

Apple CarPlay*

*: When connected as an Apple CarPlay device

Audio files on an Apple CarPlay device can be played back.

CONNECTING AN Apple CarPlay DEVICE

▶ 11.6-inch display system/11.6-inch display with Navi system

1. Connect a device compatible with Apple CarPlay. (→P.87)
2. Check the confirmation message, and then select **Yes** (Yes).
 - The Apple CarPlay screen will be displayed.
 - If **No** (No) is selected, Apple CarPlay will not start. When connected to a USB port, the device will be recognized as an iPod/iPhone. (→P.170) When not connected to a USB port, the device will be recognized as a Bluetooth device. (→P.173)

▶ Dual 7.0-inch display system

1. Connect a device compatible with Apple CarPlay. (→P.69)
2. Check the confirmation message, and then select **Yes** (Yes).
 - The Apple CarPlay screen will be displayed.
 - If **No** (No) is selected, Apple CarPlay will not start, and the device will be recognized as an iPod/iPhone. (→P.170)

- If “Don’t show again.” is selected, the confirmation message will not be displayed again. If the connected iPhone is not recognized as an Apple CarPlay device, select the device from the Apple CarPlay device list to enable the device. (→P.136)

NOTE

- Use an undamaged genuine USB cable when using this function. (Dual 7.0-inch display system only)
- Enable Apple CarPlay in the Apple CarPlay device’s restriction settings before using this function.

OVERVIEW

Select **Apple CarPlay** (Apple CarPlay) on the media control screen. (→P.151)

► **Control panel**



1	Turn to adjust the volume. Press to mute the audio system. Press and hold to turn the audio system off, and press and hold to turn it on again.
2	Turn to change the track. Press and hold to display the sound customization screen. (→P.153)

► **Control screen**

► **11.6-inch display system/11.6-inch display with Navi system**

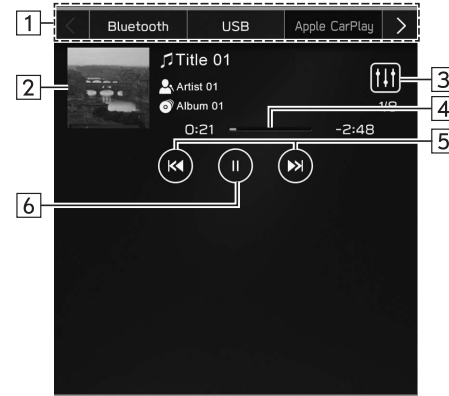

► **Dual 7.0-inch display system**



1	Select to switch between other media sources.
2	Displays cover art.
3	Select to display the sound customization screen. (→P.153)
4	Shows progress.
5	Select to change the track. Select and hold to fast forward/rewind.
6	Select to pause/play.

WARNING

- Do not operate or connect an Apple CarPlay device while driving.
 - This system is fitted with Wi-Fi® antennas. People with implantable cardiac pacemakers, cardiac resynchronization therapy-pacemakers or implantable cardioverter defibrillators should maintain a reasonable distance between themselves and the Wi-Fi® antennas. The radio waves may affect the operation of such devices.
 - Before using Wi-Fi® devices, users of any electrical medical device other than implantable cardiac pacemakers, cardiac resynchronization therapy-pacemakers or implantable cardioverter defibrillators should consult the manufacturer of the device for information about its operation under the influence of radio waves.
- Radio waves could have unexpected effects on the operation of such medical devices.

CAUTION

- Do not leave your Apple CarPlay device in the vehicle. In particular, high temperatures inside the vehicle may damage it.
- Do not push down on or apply unnecessary pressure to the connector area of the Apple CarPlay device while it is connected as this may damage the device or its terminals.
- Do not insert foreign objects into the port as this may damage the device or its terminals.

NOTE

- When an Apple CarPlay device is connected using an undamaged genuine Apple CarPlay device cable, battery of the Apple CarPlay device will be charged.
- When playing music on an Apple CarPlay device, operate the Apple CarPlay device from the system. Furthermore, depending on the connected Apple CarPlay device, certain functions may not be available.
- Depending on the Apple CarPlay device or music file being played, the cover art may not be displayed.
- When an Apple CarPlay device is connected and the audio source is changed to Apple CarPlay device mode, the Apple CarPlay device will resume playing from the same point it was last used.
- Tracks selected by operating a connected Apple CarPlay device may not be recognized or displayed properly.

Android Auto*

*: When connected as an Android Auto device

Audio files on an Android Auto device can be played back.

CONNECTING AN Android Auto DEVICE

► 11.6-inch display system/11.6-inch display with Navi system

The Android Auto application can be used in either of the following methods:

- Register a device compatible with Android Auto to the vehicle system then connect it wirelessly. (→P.138)
- Connect a device compatible with Android Auto to a USB port. (→P.138)

► Dual 7.0-inch display system

To use the Android Auto application, connect your Android Auto device to the USB port. (→P.138)

- If “Don’t show again.” is selected, the confirmation message will not be displayed again. If the connected Android Auto device is not recognized as an Android Auto device, select the check box for the device on the Android Auto device list. (→P.140)

OVERVIEW

Select **Android Auto** (Android Auto) on the media control screen. (→P.151)

► Control panel



1	Turn to adjust the volume. Press to mute the audio system. Press and hold to turn the audio system off, and press and hold to turn it on again.
2	Turn to change the track. Press and hold to display the sound customization screen. (→P.153)

► **Control screen**

► **11.6-inch display system/11.6-inch display with Navi system**

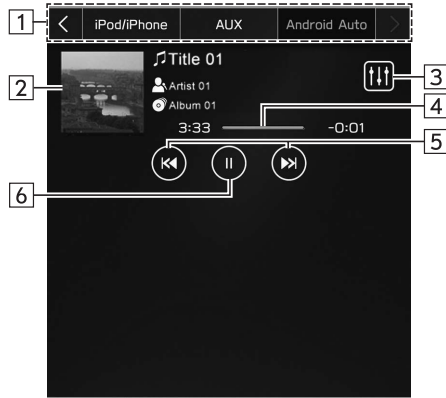

1	Select to switch between other media sources.
2	Displays cover art.
3	Select to display the sound customization screen. (→P.153)
4	Shows progress.
5	Select to change the track.
6	Select to pause/play.

► **Dual 7.0-inch display system**

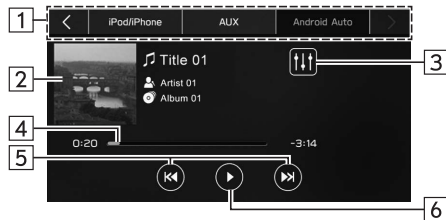

⚠ WARNING

- Do not operate or connect an Android Auto device while driving.
- This system is fitted with Wi-Fi® antennas. People with implantable cardiac pacemakers, cardiac resynchronization therapy-pacemakers or implantable cardioverter defibrillators should maintain a reasonable distance between themselves and the Wi-Fi® antennas. The radio waves may affect the operation of such devices.
- Before using Wi-Fi® devices, users of any electrical medical device other than implantable cardiac pacemakers, cardiac resynchronization therapy-pacemakers or implantable cardioverter defibrillators should consult the manufacturer of the device for information about its operation under the influence of radio waves.

Radio waves could have unexpected effects on the operation of such medical devices.

⚠ CAUTION

- Do not leave your Android Auto device in the vehicle. In particular, high temperatures inside the vehicle may damage it.
- Do not push down on or apply unnecessary pressure to the connector area of the Android Auto device while it is connected as this may damage the device or its terminals.
- Do not insert foreign objects into the port as this may damage the device or its terminals.

NOTE

- Depending on the device or music file being played, the cover art may not be displayed.

AUDIO REMOTE CONTROLS

STEERING WHEEL CONTROLS

Some parts of the audio system can be controlled using the steering wheel controls.

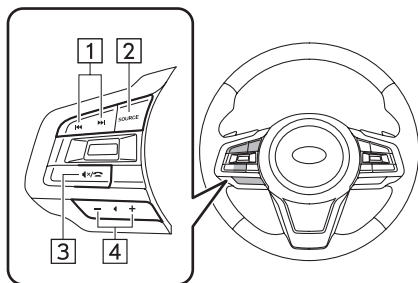

1	"⏮ / ⏭" switch
2	"Source" switch
3	"🔇 / 🗣" switch
4	"+/-" switch

▶ "⏮ / ⏭" switch

Mode	Operation	Function
AM/FM Radio, SiriusXM®	Press	Preset station/channel up/down
	Press and hold	Scan and stop at the first received station when the switch is released
USB, iPod/iPhone, Bluetooth audio, Apple CarPlay	Press	Change a track/file
	Press and hold	Fast forward/rewind
Android Auto	Press	Change a track

▶ "Source" switch

Mode	Operation	Function
All	Press	Turn on the audio system or change the audio source mode
	Press and hold	Turn off the audio system

▶ “ / ” switch

Mode	Operation	Function
All	Press	Audio volume mute on/off.

▶ “+/-” switch

Mode	Operation	Function
Volume	Press	Volume up/down
	Press and hold	Volume up/down continuously

NOTE

- In the SUBARU STARLINK mode, some operation may be done on the screen depend on the selected APPS.

TIPS FOR OPERATING THE AUDIO SYSTEM

OPERATING INFORMATION

CAUTION

- To avoid damage to the audio system, be careful not to spill beverages over the audio system.

NOTE

- The use of a cellular phone inside or near the vehicle may cause a noise from the speakers of the audio system which you are listening to. However, this does not indicate a malfunction.

RADIO

Usually, a problem with radio reception does not mean there is a problem with the radio — it is just the normal result of conditions outside the vehicle.

For example, nearby buildings and terrain can interfere with FM reception. Power lines or phone wires can interfere with AM signals. And of course, radio signals have a limited range. The farther the vehicle is from a station, the weaker its signal will be. In addition, reception conditions change constantly as the vehicle moves.

Here, some common reception problems that probably do not indicate a problem with the radio are described.

FM

Fading and drifting stations: Generally, the effective range of FM is about 25 miles (40 km). Once outside this range, you may notice fading and drifting, which increase with the distance from the radio transmitter. They are often accompanied by distortion.

Multi-path: FM signals are reflective, making it possible for 2 signals to reach the vehicle's antenna at the same time. If this happens, the signals will cancel each other out, causing a momentary flutter or loss of reception.

Static and fluttering: These occur when signals are blocked by buildings, trees or other large objects. Increasing the bass level may reduce static and fluttering.

Station swapping: If the FM signal being listened to is interrupted or weakened, and there is another strong station nearby on the FM band, the radio may tune in the second station until the original signal can be picked up again.

AM

Fading: AM broadcasts are reflected by the upper atmosphere — especially at night. These reflected signals can interfere with those received directly from the radio station, causing the radio station to sound alternately strong and weak.

Station interference: When a reflected signal and a signal received directly from a radio station are very nearly the same frequency, they can interfere with each other, making it difficult to hear the broadcast.

Static: AM is easily affected by external sources of electrical noise, such as high tension power lines, lightening or electrical motors. This results in static.

SiriusXM®

- Cargo loaded on the roof luggage carrier, especially metal objects, may adversely affect the reception of SiriusXM® Radio.
- Alternation or modifications carried out without appropriate authorization may invalidate the user's right to operate the equipment.

USB MEMORY DEVICE

- USB communication formats: USB 2.0 LS (1.5 Mbps)/FS (12 Mbps)/HS (480 Mbps)
- File formats: FAT 32
- Correspondence class: Mass storage class

iPod/iPhone

The following iPod touch and iPhone devices can be used with this system.

Made for

- iPhone 12 Pro Max
- iPhone 12 Pro
- iPhone 12
- iPhone 12 mini
- iPhone 11 Pro Max
- iPhone 11 Pro
- iPhone 11
- iPhone XS Max
- iPhone XS
- iPhone XR
- iPhone X
- iPhone 8 Plus
- iPhone 8
- iPhone 7 Plus
- iPhone 7

- iPhone SE
- iPhone 6s Plus
- iPhone 6s
- iPhone 6 Plus
- iPhone 6
- iPod touch (7th generation)
- iPod touch (6th generation)
- For USA customers, please visit www.subaru.com for details. Outside of the USA customers, contact your local dealer to arrange a demonstration in order to confirm whether or not the phone can be paired with the vehicle.

FILE INFORMATION

Codec	Description	Channels	Container/Extension
MPEG-4 AAC LC	8-48 kHz sampling rate 8-320 kbps CBR, VBR	Mono and stereo	.m4a, .aac
MPEG-4 HE AAC	16-48 kHz sampling rate 8-320 kbps CBR, VBR	Mono and stereo	.m4a, .aac
MPEG-4 HE AAC v2	16-48 kHz sampling rate 8-320 kbps CBR, VBR	Mono and stereo	.m4a, .aac
MP3	8-48 kHz sampling rate 8-320 kbps CBR, VBR	Mono, Stereo, and Joint	.mp3
WMA2/7/8/9/9.1/9.2	16-48 kHz sampling rate 8-320 kbps CBR, VBR	Mono and stereo	.wma

Codec	Description	Channels	Container/ Extension
PCMWAVE	8 bit and 16 bit 8000, 16000, and 44100 Hz sampling frequency	Mono and stereo	.wav
FLAC	44.1 kHz, 48 kHz, 88.2 kHz, 96 kHz, 176.4 kHz, 192 kHz sampling rate 16 bit, 24 bit	Mono and stereo	.flac
ALAC	44.1 kHz, 48 kHz, 88.2 kHz, 96 kHz, 176.4 kHz, 192 kHz sampling rate 16 bit, 24 bit	Mono and stereo	.m4a

- The player is compatible with VBR (Variable Bit Rate).
- MP3 (MPEG Audio Layer 3), WMA (Windows Media Audio) and AAC (Advanced Audio Coding) are audio compression standards.
- This system can play AAC/AAC+ v2/MP3/WMA files on USB memory device and Bluetooth device.
- When naming an AAC/AAC+ v2/MP3/WMA file, add an appropriate file extension (.mp3/.wma/.m4a).

- This system plays back files with .mp3/.wma/.m4a file extensions as AAC/AAC+ v2/MP3/WMA files respectively. To prevent noise and playback errors, use the appropriate file extension.
- MP3 files are compatible with the ID3 Tag Ver. 1.0, Ver. 1.1, Ver. 2.2 and Ver. 2.3 formats. This system cannot display folder name, file name and artist name in other formats.
- WMA/AAC files can contain a WMA/AAC tag that is used in the same way as an ID3 tag. WMA/AAC tags carry information such as file name and artist name.
- This system can play back AAC files encoded by iTunes.
- The sound quality of MP3/WMA files generally improves with higher bit rates. In order to achieve a reasonable level of sound quality, USB memory device recorded with a bit rate of at least 128 kbps are recommended.
- MP3i (MP3 interactive) and MP3PRO formats are not compatible with the audio device.
- When playing back files recorded as VBR (Variable Bit Rate) files, the play time will not be correctly displayed if the fast forward or rewind operations are used.
- It is not possible to check folders that do not include AAC/AAC+ v2/MP3/WMA files.

- AAC/AAC+ v2/MP3/WMA files in folders up to 3 levels deep can be played. However, the start of playback may be delayed when using USB memory device containing numerous levels of folders. For this reason, we recommend creating USB memory device with no more than 2 levels of folders.

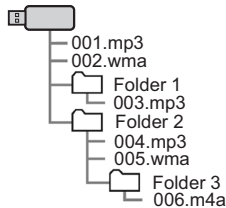

- The play order may change depending on the personal computer and AAC/AAC+ v2/MP3/WMA encoding software that were used.
- WMA (Windows Media Audio) is an audio compression format developed by Microsoft®. It compresses files into a size smaller than that of MP3 files. The decoding formats for WMA files are Ver. 7, 8 and 9. This product is protected by certain intellectual property rights of Microsoft Corporation and third parties. Use or distribution of such technology outside of this product is prohibited without a license from Microsoft or an authorized Microsoft subsidiary and third parties.

- MP3 is an audio compression standard determined by a working group (MPEG) of the ISO (International Standard Organization). MP3 compresses audio data to about 1/10 the size of that on conventional discs.

Navigation System

(If equipped)



Basic Operation	192
Map Screen	192
Map Screen Overview	192
Map Screen Buttons Overview	193
Map Screen Operation	193
Current Position Display	193
Map Scale	194
Location Menu Pop-up	194
Orientation Of The Map	195
Map Screen Information	197
Gas Station/Parking Lot/Rest Area Icons	197
Traffic Information	197
Other Information	198
Main Menu Screen	199
Main Menu Screen Overview	199
Search Screen	201
Favorites Screen	203
Edit List Screen	206

Route Calculation	206
Route Calculation Screen	206
Route Guidance	208
Route Guidance	208
Route Guidance Screen	208
Current Route Screen	211
Standard Map Icon	213
Typical Voice Guidance Prompts	214
Setup	215
Navigation Settings	215
Navigation Settings Screen	215

Tips For The Navigation System	217
GPS (Global Positioning System)	217
Regarding Errors In Current Position Display	217
Limitations Of The Navigation System	217
Map Data	219
Regarding Roads And Place Name Data	219
SUBARU Map Update	219
Updating The Map Data Manually	
Using A USB Memory Device	220
Updating The Map Data Manually	
Using Wi-Fi®	221
Updating The Map Data Automatically	
Using Wi-Fi®	222
Updating The Map Data Manually	
Using A Smartphone	222

BASIC OPERATION





MAP SCREEN

MAP SCREEN OVERVIEW

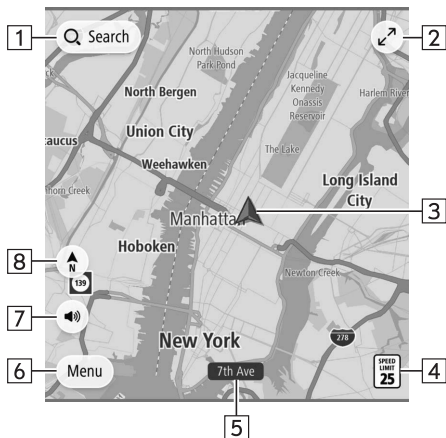
The map screen can be displayed using the following method:

1. Display the home screen. (→P.43)
2. Select **Map** (Map).



1	Select to display the search screen. (→P.201)
2	Select to increase the size of the map screen. Select  to reduce the size of the map screen.
3	Displays the current vehicle position. Select to display the following pop-up: <ul style="list-style-type: none"> • Add to Favorites (Add to Favorites): Select to register your current location as a favorite. • Avoid Blocked Road (Avoid Blocked Road)*: Select to display the alternate route screen and search for 3 additional routes to the selected destination. (→P.206) • Current Location (Current Location): Select to display the current position information.
4	Displays the speed limit for the road currently being traveled on.
5	Displays the current street name.
6	Select to display the main menu screen. (→P.199)
7	Select to set a voice guidance. <ul style="list-style-type: none"> •  : Enables voice guidance •  : Enables the voice guidance of alerts only •  : Disables voice guidance

8

Select to change the map display mode between 2D north-up, 2D heading-up, or 3D heading-up. (→P.195)

*: This item can only be displayed when a route is set.

MAP SCREEN BUTTONS OVERVIEW

The map screen buttons can be accessed by selecting any point on the map.

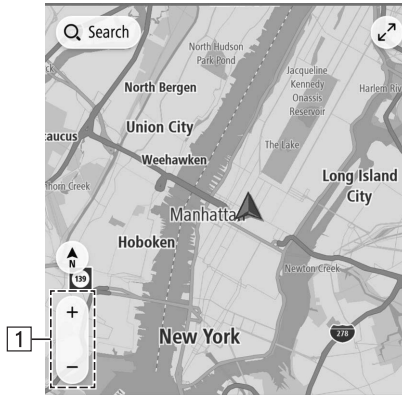

1

Select to change the scale of the map screen. (→P.194)

MAP SCREEN OPERATION

CURRENT POSITION DISPLAY

After moving the map, **Re-center** (Re-center) may be displayed. Select **Re-center** (Re-center) to return the map to the current position.

NOTE

- While driving, the current position mark is fixed on the screen and the map moves.
- The current position is automatically set as the vehicle receives signals from the GPS (Global Positioning System). If the current position is not correct, it is automatically corrected after the vehicle receives signals from the GPS.
- If the battery has been disconnected or when the vehicle is new, the current position may not be correct. As soon as the system receives signals from the GPS, the correct current position will be displayed.
- After moving the map, if it is not moved for a certain amount of time, it will automatically return to the current position.

MAP SCALE

1. Select any point on the map.
2. Select **+** or **-** to change the scale of the map screen.
 - When the automatic zoom function is on (→P.215) during route guidance, the map is zoomed in automatically when approaching intersections or turning points.

NOTE

- The scale of the map screen can also be changed with the double touch or pinch operation. (→P.70)
- If the map scale has been changed after moving the map, the map scale will return to previous scale when the map is returned to the current position.
- The automatic zoom function may not operate if the map scale is adjusted manually during route guidance. To reenale the automatic zoom function, change the orientation of the map screen. (→P.195)

LOCATION MENU POP-UP

The location menu pop-up can be displayed using the following methods:

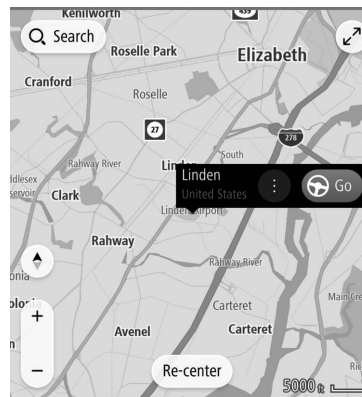

- Select and hold any point on the map.
- Select a point from a list.
- Select a POI icon.



Select **Go** (Go) to search for a route to the selected point and display the route calculation screen. (→P.206)

During a route guidance, selecting **Add Stop** (Add Stop) will add a waypoint.

Select  to display the following options.

Add to Favorites (Add to Favorites)	Select to register the selected point as a favorite.
Go (Go)	Select to search for a route to the selected point and display the route calculation screen. (→P.206)
Search Near Here (Search Near Here)	Select to display the search screen and search near the selected point. (→P.201)
More Information (More Information)	Select to display detailed information about the selected point or POI.  : Select to call the registered phone number of POI.  : Select to search for a route to the selected point or POI and display the route calculation screen. (→P.206)
Edit Location (Edit Location)	Select to edit the point registered as home/work.
Remove Location (Remove Location)	Select to erase the point registered as home/work.
Rename (Rename)	Select to change the name of a registered favorite.

ORIENTATION OF THE MAP

The orientation of the map can be changed between 2D north-up, 2D heading-up, and 3D heading-up.

1. Select , , or .

- Each time the symbol is selected, the orientation of the map changes.

► 2D north-up

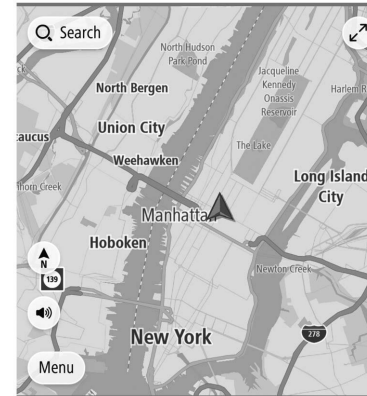

- Regardless of the direction of vehicle travel, north is always up.

► 3D heading-up

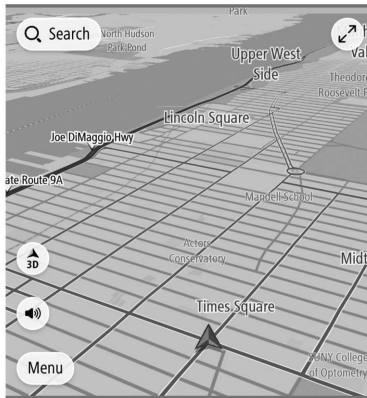

- The direction of vehicle travel is always up.

► 2D heading-up

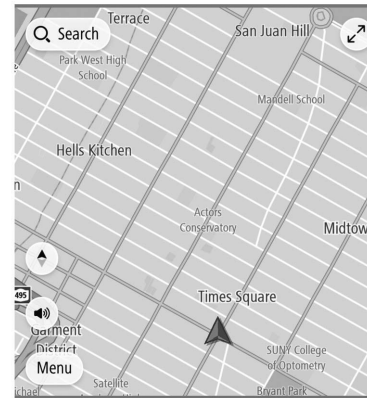

- The direction of vehicle travel is always up.

MAP SCREEN INFORMATION

GAS STATION/PARKING LOT/REST AREA ICONS

Gas stations, parking lots and rest areas can be displayed on the route. Their location can also be set as a destination.

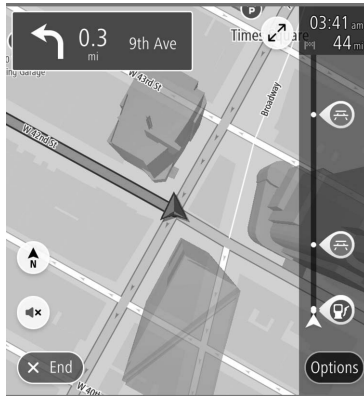

- The display of gas station/parking lots/rest area icons can be turned on/off. (→P.215)

TRAFFIC INFORMATION*

*: Use of this function may not be possible depending on country and vehicle.

Road sections affected by traffic conditions are displayed in a different color on the map, and a small icon representing the type of traffic condition is displayed above the road.

This feature is available at certain map scales.

To receive the data service information in the vehicle, a subscription to the SiriusXM® Radio Service is necessary following a free trial. (→P.165)

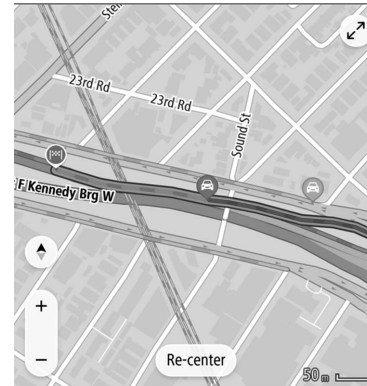

OTHER INFORMATION

A pop-up screen will be displayed based on the driving situation, etc.

► Low fuel warning

When the fuel level is low, a warning message will pop up on the screen.

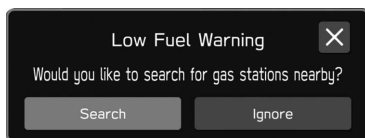

- **Search** (Search): Select to search for gas stations.
- **Ignore** (Ignore): Select to delete the message.

► Periodic rest notification

If the system determines, based on the driver's condition, that a rest may be necessary, a pop-up message will be displayed on the screen.

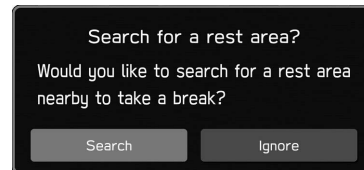

- **Search** (Search): Select to search for rest areas.
- **Ignore** (Ignore): Select to delete the message.
- Pop-up screens can be turned on/off using the "Periodic Rest Notification" setting on the general settings screen. (→P.92)

MAIN MENU SCREEN

MAIN MENU SCREEN OVERVIEW

The main menu screen can be displayed using the following method:

1. Display the map screen. (→P.192)
2. Select **Menu** (Menu).

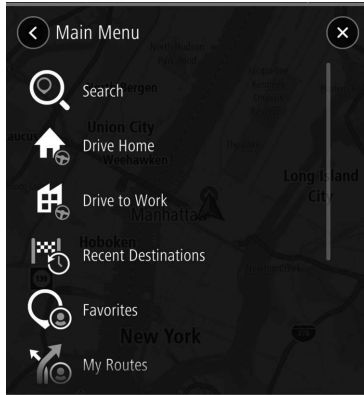

Search (Search)	Select to display the search screen. (→P.201)
Add Home (Add Home)*1/ Drive Home (Drive Home)*2	Add Home (Add Home): Select to register a point as home. (→P.205) Drive Home (Drive Home): Select to set the point registered as home as the destination.
Add Work (Add Work)*3/ Drive to Work (Drive to Work)*4	Add Work (Add Work): Select to register a point as work. (→P.205) Drive to Work (Drive to Work): Select to set the point registered as work as the destination.
Recent Destinations (Recent Destinations)	Select to display a list of recently set destinations. Then select a point from the list. Location menu pop-up for the point will be displayed on the map screen. (→P.194) • Edit List (Edit List): Select to display the edit list screen. (→P.206)
Favorites (Favorites)	Select to display the favorite screen. (→P.203)

<p>My Routes (My Routes)*⁵</p>	<p>Select to name the current route and register it so that it can be used repeatedly. (→P.211) My route name: Select a registered route to display the route calculation screen. (→P.206)</p> <p>Edit List (Edit List): Select to display the edit list screen. (→P.206)</p>
<p>Maps (Maps)</p>	<p>Select to display the map update screen. (→P.221)</p>
<p>Legal Information (Legal Information)</p>	<p>Select to display the legal information screen.</p>
<p>Settings (Settings)</p>	<p>Select to display the navigation settings screen. (→P.215)</p>
<p>Privacy (Privacy)</p>	<p>To display frequently set destinations, select “Keep trip history on this device for optional features” and “Predict frequent destinations” to on then select Frequent destinations (Frequent destinations).</p>

*1: If a point has not been registered as home.

*2: If a point has been registered as home.

*3: If a point has not been registered as work.

*4: If a point has been registered as work.

*5: This item can only be selected when a route has been registered to My Routes.

SEARCH SCREEN

Destinations can be set by address, category, POI, etc.

By entering three words hit by search using the “what3words” function, destinations can be set for places where postal address is not precisely allocated.



1

Enter keyword(s) to search for a destination.
To use “what3words”, enter “ . ” in-between the three words.
Search results screen will be displayed. (→P.202)

2

Select to set the radius filter. Once the radius filter has been set, a search will only be performed for items within that radius.

3

Select to display the current vehicle position.

4

Select to select a POI category. Search will be performed within the radius filter set.

Search results screen will be displayed. (→P.202)

- **Show Subcategories** (Show Subcategories): Select to display more detailed categories.

Select  to display other POI categories.

- **Browse Categories** (Browse Categories): Select to display all of the POI categories.

5	<p>Add Home (Add Home): Select to register a point as home. (→P.205)</p> <p>Home (Home): Select to set the point registered as home as the destination.</p> <ul style="list-style-type: none"> • Go (Go): Select to display the route calculation screen. (→P.206) • ⋮: Select to display location menu pop-up. (→P.194)
	<p>Add Work (Add Work): Select to register a point as work. (→P.205)</p> <p>Work (Work): Select to set the point registered as work as the destination.</p> <ul style="list-style-type: none"> • Go (Go): Select to display the route calculation screen. (→P.206) • ⋮: Select to display location menu pop-up. (→P.194)
	<p>📍 *****: Select to display the last set destination.</p> <ul style="list-style-type: none"> • Go (Go): Select to display the route calculation screen. (→P.206) • ⋮: Select to display location menu pop-up. (→P.194)
	<p>★: Select to display the favorite screen. (→P.203)</p>
	<p>📍: Select to display a list of recently set destinations. Then select a point from the list. Location menu pop-up for the point will be displayed on the map screen. (→P.194)</p> <ul style="list-style-type: none"> • Edit List (Edit List): Select to display the edit list screen. (→P.206)

6	Each time the button is selected, select to display/hide the keyboard.
7	Select to display the search map screen.
8	Select to display the search list screen.

SEARCH RESULTS SCREEN

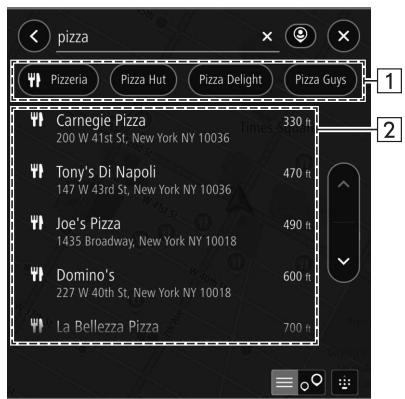

1	Select to narrow down the list by POI category.
---	---

2

Some candidate destinations are displayed based on the input characters. The location menu pop-up is displayed on the map screen when an item is selected. (→P.194)

If a non-specific point is selected, such as a street name, the following items will be displayed.

- **Show on Map** (Show on Map): Select to display the location menu pop-up on the map screen. (→P.194)
- **Add Crossroad** (Add Crossroad): Select to select an intersecting road and further refine the results.
- **Go** (Go): Select to search for a route to the selected destination. (→P.206)

FAVORITES SCREEN

The desired point can be registered as home, work, or favorite.





The registered points can be set as a destination.

Registered points can be added, changed and deleted on the favorites screen.

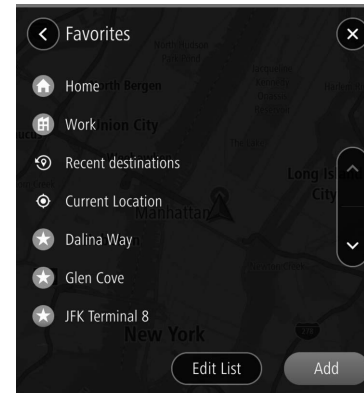
The favorites screen can be accessed with the following method:

1. Display the map screen. (→P.192)
2. Select **Menu** (Menu).
3. → **Favorites** (Favorites)



	<p>Add Home (Add Home): Select to register the home. (→P.205)</p> <p>Home (Home): Select to display the location menu pop-up for the point registered as home on the map screen. (→P. 194)</p>
	<p>Add Work (Add Work): Select to register the work. (→P.205)</p> <p>Work (Work): Select to display the location menu pop-up for the point registered as work on the map screen. (→P. 194)</p>
	<p>Select to display the recent destination screen. Recent destinations: Select a recent destination to display the location menu pop-up for that point on the map screen. (→P. 194)</p> <p>Edit List (Edit List): Select to display the edit list screen to delete the recent destinations. (→P.206)</p>
	<p>Select to display information of the current location.</p>
	<p>Select a favorite to display the location menu pop-up for that point on the map screen. (→P. 194)</p>



<p>Edit List (Edit List)</p>	<p>Select to display the edit list screen to delete the favorites. (→P.206)</p>
<p>Add (Add)</p>	<p>Select to register the favorite. (→P.205)</p>

REGISTERING HOME/WORK/FAVORITE POINT

1. Select **Add Home** (Add Home)/ **Add Work** (Add Work)/ **Add** (Add).
2. Perform any of the following to display a point you wish to register:
 - Select  and select the desired point from the destination history.
 - Select **Set from map** (Set from map) and select the desired point on the map.
 - Enter keyword(s) in the keyword entry section and select the desired point from the candidates list.

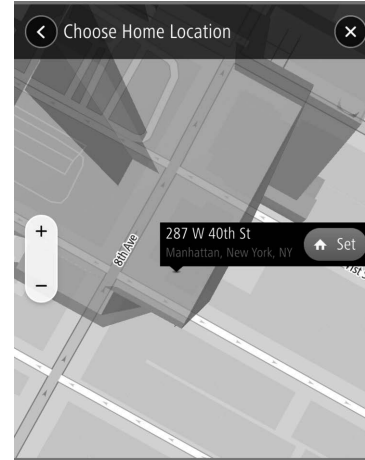
- Select the desired point on the map.



3. →  /  / 
 - To register a favorite, enter a name.
 - Icons will be displayed on the map to indicate registered points.

EDIT LIST SCREEN

Unnecessary items can be deleted on the edit list screen.



1	Select <input type="radio"/> for the item you wish to delete.
2	Select to skip to the next or previous page.
3	Select to delete selected item(s).
4	Select to select all items. Select again to deselect all items.

ROUTE CALCULATION

ROUTE CALCULATION SCREEN

Up to 3 candidate routes searched are displayed according to conditions preset by the user.

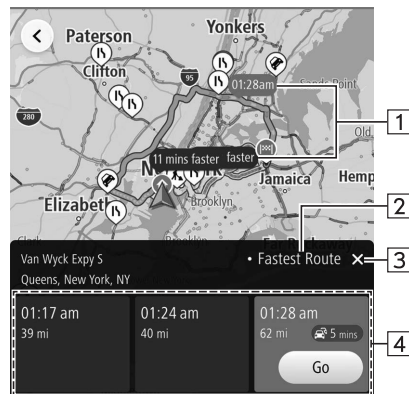

1	Candidate route overview
2	Route search conditions A route search condition ("Fastest Route", "Shortest Route", or "Most Eco-friendly Route") can be pre-set on the navigation settings screen. (→P.215)
3	Select to cancel route confirmation.

4

Candidate routes (max. 3 routes)
Displays estimated time of arrival and remaining distance of each candidate route displayed.
If traffic jam is detected on the route, expected delay time will also be displayed.
Select **Go** (Go) to start route guidance.

⚠ WARNING

- Be sure to obey traffic regulations and keep road conditions in mind while driving. If a traffic sign on the road has been changed, the route guidance may not indicate such changed information.

NOTE

- The route for returning may not be the same as that for going.
- The route guidance to the destination may not be the shortest route or a route without traffic congestion.
- Route guidance may not be available if there is no road data for the specified location.
- If a destination that is not located on a road is set, the vehicle will be guided to the point on a road nearest to the destination. The road nearest to the selected point is set as the destination.

ROUTE GUIDANCE

ROUTE GUIDANCE

ROUTE GUIDANCE SCREEN

During route guidance, various types of guidance screens can be displayed depending on conditions.

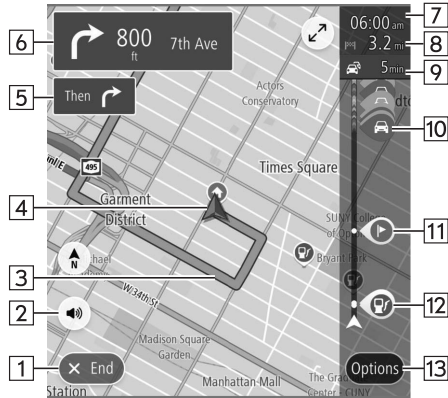

1	Select to stopping route guidance.
2	Select to enable/disable voice guidance. (→P.192)
3	Guidance route To display the current route screen, select the guidance route then  and Manage Route (Manage Route). (→P.211)
4	Current position
5	Guidance display after next
6	Next guidance display Displays the next street name, distance to the next turn, and an arrow indicating the turning direction. Select to display the route event list screen.
7	Estimated time of arrival Select to change the displayed information between a waypoint and the destination. <ul style="list-style-type: none"> • Select and hold to turn display of the route bar on/off. • If "Auto-Hide Route Bar" on the navigation settings screen is turned on, the route bar will automatically be hidden and will only be displayed when new route information is available.
8	Remaining distance and/or remaining time The displayed details can be changed on the navigation settings screen. (→P.215)
9	Displays the change in travel time.

10	<p>Traffic information icon Select to display the traffic information pop-up.</p> <p>Avoid (Avoid): Select to avoid a section of the current route based on traffic information.</p> <p>More Information (More Information): Select to display detailed information for the selected traffic information.</p>
11	<p>Select to display the waypoint information pop-up.</p> <p>Delete This Stop (Delete This Stop): Select to delete the selected waypoint from the route.</p>
12	<p>Displays a POI on the route.</p> <p>Select a displayed icon to display the location menu pop-up. (→P.194)</p>
13	<p>Select to display route option screen. (→P.210)</p>

► Junction screen

When approaching an expressway exit or a complicated intersection, the map switches to a 3D display if the necessary information can be displayed. An arrow indicates the lane in which you should drive. Signs are also displayed if the information is available.

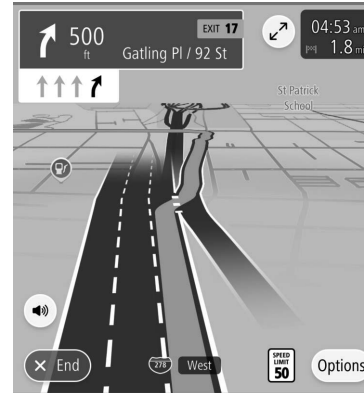

- This function can be turned on/off on the navigation settings screen. (→P.215)

► Lane recommendation screen

When approaching a turning point, the lane recommendation will be displayed automatically.



NOTE

- If the vehicle goes off the guidance route, the route is searched again.
- For some areas, the roads have not been completely digitized in our database. For this reason, the route guidance may select a road that should not be traveled on.

ROUTE OPTION SCREEN

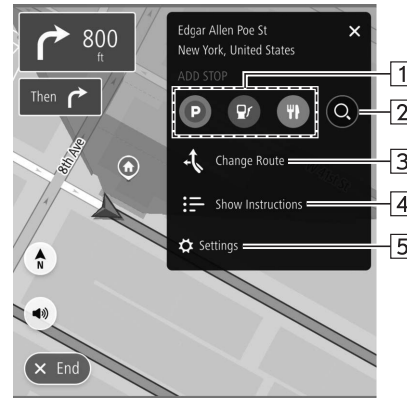

1	Select to enable search for a parking place near the destination or a gas station or restaurant along the route.
2	Select to display the search screen. (→P.201)
3	<p>Select to display the change route screen.</p> <ul style="list-style-type: none"> • Show Alternatives (Show Alternatives): Displays up to 3 candidate routes searched according to conditions preset by the user. (→P.206) • Avoid Part of Route (Avoid Part of Route): Select to display a list of sections of the current route. (→P.211) • Reorder Stops (Reorder Stops): Select to change the order of the currently set destination and waypoints. (→P.211)

4	Select to display the route details confirmation screen.
5	Select to display the navigation settings screen. (→P.215)



CURRENT ROUTE SCREEN

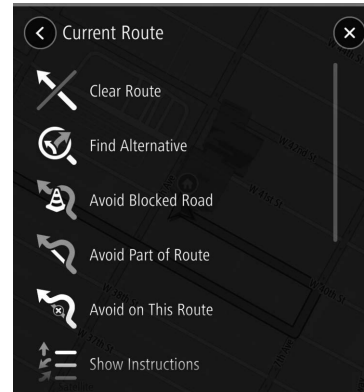

The current route screen can be displayed using the following method:

1. Select a guidance route on the route guidance screen.
2. Select .
3. → **Manage Route** (Manage Route)



Clear Route (Clear Route)	Select to stop the route guidance.
Find Alternative (Find Alternative)	Select to display the alternate route screen and search for 3 additional routes to the selected destination. (→P.206)

<p>Avoid Blocked Road (Avoid Blocked Road)</p>	<p>Select to display the alternate route screen and search for 3 additional routes which avoid the current road. (→P.206)</p>
<p>Avoid Part of Route (Avoid Part of Route)</p>	<p>Select to display a list of sections of the current route. Select the section you wish to avoid and then select  to search for a new route.</p>
<p>Avoid on This Route (Avoid on This Route)</p>	<p>Select to change the avoidance criteria for the current route and search for a different route. When avoidance criteria are changed and OK (OK) is selected, the route calculation screen will be displayed. (→P.206) This item can only be selected when the current route has a section which is included in the avoidance criteria.</p>
<p>Show Instructions (Show Instructions)</p>	<p>Select to display the route details confirmation screen.</p>
<p>Add Stop to Route (Add Stop to Route)</p>	<p>Select to search for a waypoint on the map or search screen (→P.201) and then select  to add it to the current route (→P.206).</p>
<p>Add to My Routes (Add to My Routes)</p>	<p>Select to name the current route and register it to My Routes.</p>

<p>Change Route Type (Change Route Type)</p>	<p>Select to change the route type of the current route and search for a new route. When route types are changed, the route calculation screen will be displayed. (→P.206)</p>
<p>Reorder Stops (Reorder Stops)</p>	<p>Select to change the order of the currently set destination and waypoints. Select a destination, select  or  to change its position in the list, and then select Done (Done) to confirm the change. Edit Stops (Edit Stops): Select to display the edit stops screen. To delete a waypoint, select  then Delete (Delete).</p>
<p>Play Route Preview (Play Route Preview)/ Stop Route Preview (Stop Route Preview)</p>	<p>Play Route Preview (Play Route Preview): Select to enter route preview mode. (→P.213) Stop Route Preview (Stop Route Preview): Select to exit route preview mode.</p>

PREVIEWING THE ROUTE

A selected route can be previewed.

The speed of the preview can be changed.

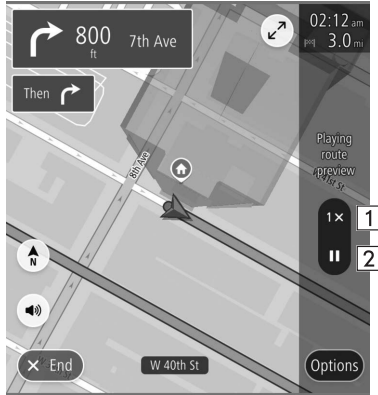



1	Select to change the preview speed to "1X"/"2X"/"4X".
2	Select to temporarily stop the preview.

STANDARD MAP ICON

The following table shows the most frequently displayed route events.

	Turn left/right
	U-turn
	Keep left/right at the fork in the road.
	Turn left/right & sharp curve.
	Stay in the left/right lane.
	Go straight ahead at the intersection.
	Exit the junction
	Roundabout
	You have arrived at your destination.
	You have arrived at your waypoint.

	Toll road
	Freeway
	Ferry trip

TYPICAL VOICE GUIDANCE PROMPTS

As the vehicle approaches an intersection, or point, where maneuvering the vehicle is necessary, the system's voice guidance will provide various messages.

WARNING

- Be sure to obey the traffic regulations and keep the road condition in mind, especially when driving on IPD roads (roads that are not completely included in the map database). The route guidance may not have the most up-to-date information, such as the direction of a one way street.

NOTE

- To adjust the voice guidance volume: →P.98
- Setting voice guidance: →P.192
- Voice guidance may be made early or late.
- If the system cannot determine the current position correctly, you may not hear voice guidance or may not see the magnified intersection on the screen.

SETUP

NAVIGATION SETTINGS

1. Display the home screen. (→P.43)
2. Select **Settings** (Settings).
3. → **Navigation** (Navigation)
4. Select the desired item to be set.

NAVIGATION SETTINGS SCREEN

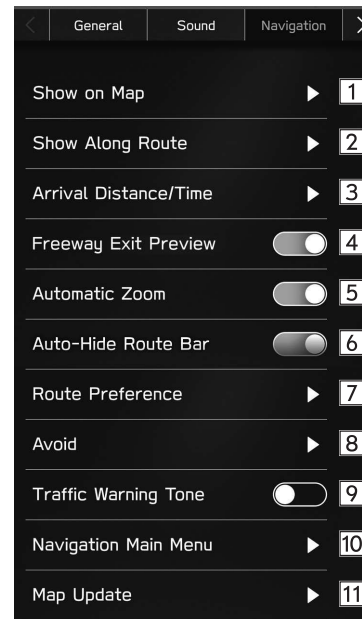

1	POI icons can be displayed on the map screen when “Show POI Icons on Map” is turned on and up to 5 POI icon types have been selected.
2	Select to turn the display for parking lots, gas stations and rest areas on/off for the route being traveled during route guidance.
3	Select to set the displays for the estimated remaining distance and estimated remaining time to the destination. (→P.208)
4	Select to turn the freeway exit preview on/off.
5	Select to set whether to automatically enlarge the map when approaching intersections or turning points during route guidance.
6	Select to turn the route bar auto-hide function on/off. (→P.208)
7	Select to change the preferred route type when searching for a new route.
8	Select to set avoidance criteria for the route calculation.
9	Select to turn the traffic alert sound on/off.
10	During a route guidance: Select to display route option screen. (→P.210) Not during a route guidance: Select to display the main menu screen. (→P.199)
11	Select to set the updating of map data. (→P.219)

TIPS FOR THE NAVIGATION SYSTEM

GPS (GLOBAL POSITIONING SYSTEM)**REGARDING ERRORS IN CURRENT POSITION DISPLAY**

The system displays the vehicle current position based on GPS information and data from various sensors and road maps. However, when the radiowave signals from GPS satellites are weak or when signals are received from only two satellites or less, errors may occur in the position. Modifying or adjusting the system will not prevent these errors.

LIMITATIONS OF THE NAVIGATION SYSTEM

This navigation system calculates the current position using satellite signals, various vehicle signals, map data, etc. However, an accurate position may not be shown depending on satellite conditions, road configuration, vehicle condition or other circumstances.

The Global Positioning System (GPS) developed and operated by the U.S. Department of Defense provides an accurate current position, normally using 4 or more satellites, and in some case 3 satellites. The GPS system has a certain level of inaccuracy. While the navigation system compensates for this most of the time, occasional positioning errors of up to 300 feet (100 m) can and should be expected. Generally, position errors will be corrected within a few seconds.

The GPS signal may be physically obstructed, leading to inaccurate vehicle position on the map screen. Tunnels, tall buildings, trucks, or even the placement of objects on the instrument panel may obstruct the GPS signals.

The GPS satellites may not send signals due to repairs or improvements being made to them.

Even when the navigation system is receiving clear GPS signals, the vehicle position may not be shown accurately or inappropriate route guidance may occur in some cases.

⚠ CAUTION

- The installation of window tinting may obstruct the GPS signals. Most window tinting contains some metallic content that will interfere with GPS signal reception of the antenna in the instrument panel. We advise against the use of window tinting on vehicles equipped with navigation systems.

- Accurate current position may not be shown in the following cases:
 - When driving on a small angled Y-shaped road.
 - When driving on a winding road.
 - When driving on a slippery road such as in sand, gravel, snow, etc.
 - When driving on a long straight road.
 - When freeway and surface streets run in parallel.
 - After moving by ferry or vehicle carrier.
 - When a long route is searched during high speed driving.
 - After repeating a change of direction by going forward and backward, or turning on a turntable in a parking lot.
 - When leaving a covered parking lot or parking garage.
 - When a roof carrier is installed.
 - When driving with tire chains installed.
 - When the tires are worn.
 - After replacing a tire or tires.
 - When using tires that are smaller or larger than the factory specifications.
 - When the tire pressure in any of the 4 tires is not correct.
- Inappropriate route guidance may occur in the following cases:
 - When turning at an intersection off the designated route guidance.
 - If you set more than 1 destination but skip any of them, auto reroute will display a route returning to the destination on the previous route.
 - When turning at an intersection for which there is no route guidance.
 - When passing through an intersection for which there is no route guidance.
 - During auto reroute, the route guidance may not be available for the next turn to the right or left.
 - During high speed driving, it may take a long time for auto reroute to operate. In auto reroute, a detour route may be shown.
 - After auto reroute, the route may not be changed.
 - If an unnecessary U-turn is shown or announced.
 - If a location has multiple names and the system announces 1 or more of them.
 - When a route cannot be searched.
 - If the route to your destination includes gravel, unpaved roads or alleys, the route guidance may not be shown.
 - Your destination point might be shown on the opposite side of the street.

- When a portion of the route has regulations prohibiting the entry of the vehicle that vary by time or season or other reasons.
- The road and map data stored in the navigation system may not be complete or may not be the latest version.

NOTE

- This navigation system uses tire turning data and is designed to work with factory-specified tires for the vehicle. Installing tires that are larger or smaller than the originally equipped diameter may cause inaccurate display of the current position. The tire pressure also affects the diameter of the tires, so make sure that the tire pressure of all 4 tires is correct.

MAP DATA

REGARDING ROADS AND PLACE NAME DATA

When maps are created, land surveys are conducted and information on road improvements and reopening is collected to provide the most accurate information possible. However, modifications to roads, place names and facilities may be carried out at any time. Consequently, we cannot guarantee that map data contains no errors in road positions, configuration and names, or in facility names.

SUBARU MAP UPDATE

Map data can be updated using the following methods:

- USB memory: All map data can be updated at once. →P.220
- Wi-Fi®: Individual regions can be selected and their map data updated.* →P.222
- Smartphone: Individual regions can be selected and their map data updated. This method is for when the map update data is to be downloaded to a smartphone from outside of the vehicle, such as at home, and then transferred to the system. →P.222

*: Up to 8 regions can be selected for the automatic update function.

NOTE

- Map update using Wi-Fi® or a smartphone may not be available in some countries.
- For the best possible navigation experience, regularly update maps for all frequented regions, including nearby states. Failure to update maps for surrounding states may result in inaccurate map information during interstate travel. Updates made using a USB memory device will update map information for all states. Please visit [Subaru.com](https://subaru.com) for more information and the latest updates.
- If the map update fails or cannot be performed when using Wi-Fi® or a connected smartphone, check the communication status of the connected device. If there is a problem with communication, perform the procedure again using a different Wi-Fi® access point or smartphone.
- If the map update procedure fails, refer to the “TROUBLESHOOTING” section. (→P.249)
- Subaru may terminate or suspend your access to all or part of these services for any or no reason, including without limitation, any violation of the terms detailed at:
<https://subaru-maps.com/#/termsofuse>

UPDATING THE MAP DATA MANUALLY USING A USB MEMORY DEVICE

Maps can be updated using a USB memory device.

For details and to download update data, refer to the following URL:

<https://subaru-maps.com/>

1. Connect to a USB memory device. (→P.69)
2. Select **Map Update** (Map Update) on the navigation settings screen. (→P.215)
3. → **USB** (USB)
4. After the updates have been completed, turn the ignition switch to the “LOCK”/“OFF” position and exit the vehicle.
5. Close the driver’s door and lock the doors, then move at least 10 feet (3 m) away from the vehicle to prevent the key from interfering.
6. After at least 5 minutes have elapsed, start the engine again.
 - The new map data will be applied.

UPDATING THE MAP DATA MANUALLY USING Wi-Fi®

The map data may also be updated via Wi-Fi® network.

1. Connect to a Wi-Fi® network. (→P.94)
2. Select **Map Update** (Map Update) on the navigation settings screen. (→P.215)
3. → **Wi-Fi** (Wi-Fi)
4. Select the regions for which maps are to be updated.

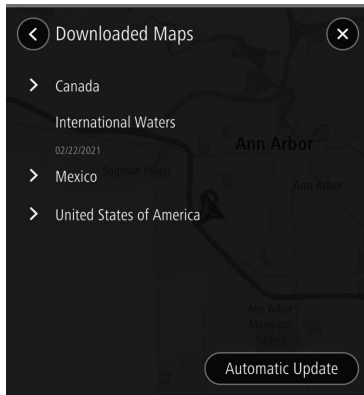

5. → **Update XX MB** (Update XX MB)
 - The update for the selected region will be automatically downloaded and installed.
6. After the updates have been completed, turn the ignition switch to the "LOCK"/"OFF" position and exit the vehicle.
7. Close the driver's door and lock the doors, then move at least 10 feet (3 m) away from the vehicle to prevent the key from interfering.
8. After at least 5 minutes have elapsed, start the engine again.
 - The new map data will be applied.

UPDATING THE MAP DATA AUTOMATICALLY USING Wi-Fi®

1. Follow “STEPS 1 to 3” in “UPDATING THE MAP DATA MANUALLY USING Wi-Fi®”. (→P.221)
2. Select **Automatic Update** (Automatic Update).
3. Set “Update maps automatically (at most 8 maps can be selected)”.
4. Select the regions that you would like to be updated.
5. After the updates have been completed, turn the ignition switch to the “LOCK”/“OFF” position and exit the vehicle.
6. Close the driver’s door and lock the doors, then move at least 10 feet (3 m) away from the vehicle to prevent the key from interfering.
7. After at least 5 minutes have elapsed, start the engine again.
 - The new map data will be applied.

UPDATING THE MAP DATA MANUALLY USING A SMARTPHONE

If the system cannot connect to a Wi-Fi® network, the map data can be updated using a smartphone. Map update data can be downloaded to a smartphone from outside of the vehicle, such as at home, and then transferred to the system to perform the map data update.

When updating the map data using a smartphone, the SUBARU STARLINK application must be installed on the smartphone.

NOTE

- When using a cellular network to download map update data, only regions with updates which are 30 MB or less can be downloaded. To download updates using a cellular network, it is necessary to turn the mobile data communication setting on the SUBARU STARLINK application on.

DOWNLOAD MAP UPDATE DATA TO A SMARTPHONE

1. Connect a smartphone to the system via Bluetooth.
 - When using an iPhone, it can also be connected using a USB cable.
2. Start the SUBARU STARLINK application on the smartphone and download the map update data.

INSTALL MAP UPDATE DATA

1. Connect a smartphone to the system via Bluetooth.
 - When using an iPhone, it can also be connected using a USB cable.
2. Select **Update Now** (Update Now).
 - If "Auto Update via Mobile" is enabled, the map update data will be installed automatically when the smartphone is connected to the system.
3. → **Yes** (Yes)

4. After the updates have been completed, turn the ignition switch to the "LOCK"/"OFF" position and exit the vehicle.
5. Close the driver's door and lock the doors, then move at least 10 feet (3 m) away from the vehicle to prevent the key from interfering.
6. After at least 5 minutes have elapsed, start the engine again.
 - The new map data will be applied.

NOTE

- When downloading map data using the SUBARU STARLINK application, make sure there is sufficient storage space on the smartphone for the selected region map data.
- When using an iPhone to perform an update, connecting the iPhone to the system via USB is recommended. In this case, if a genuine Apple USB cable is used, high speed communication is possible.
- This product uses the smartphone's data plan for features and services. Please consult carrier data plan usage, pricing, data overage charges, limitations and usage guidelines.

ABOUT THE SUPPORTED DEVICES

This system supports the following devices.

- iPhone: iOS 15.1 or later
- Android device: Android 11.0 or later

NOTE

- To ensure normal operation, updating your smartphone operating system to the latest version is recommended.

8

Voice Recognition System



Voice Recognition System Operation	226
Voice Recognition System	226
Using The Voice Recognition System	226
Voice Recognition System Operation	227
Command List	228

VOICE RECOGNITION SYSTEM OPERATION

VOICE RECOGNITION SYSTEM

The voice recognition system enables the navigation, audio, hands-free systems, etc. to be operated using voice commands.

Refer to the command list for samples of voice commands.
(→P.228)

USING THE VOICE RECOGNITION SYSTEM

STEERING SWITCH

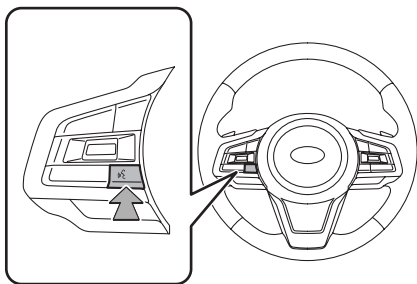

- Press the talk switch to start the voice recognition system.
- To cancel voice recognition, press and hold the talk switch.

MICROPHONE

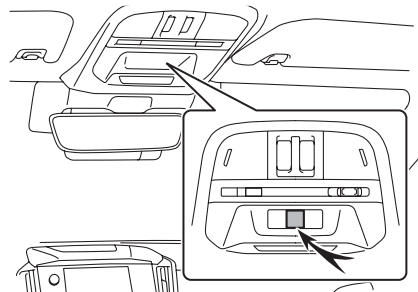

- It is unnecessary to speak directly into the microphone when giving a command.

NOTE

- This function or part of this function may not be available in some languages and countries.
- Wait for the confirmation beep before speaking a command.

NOTE

- Voice commands may not be recognized if:
 - Spoken too quickly.
 - Spoken at a low or high volume.
 - Driving with a window open.
 - Passengers are talking while voice commands are spoken.
 - The air conditioning speed is set high.
 - When air from the ventilator blows directly toward the microphone.
- In the following conditions, the system may not recognize the command properly and using voice commands may not be possible:
 - The command is incorrect or unclear. Note that certain words, accents or speech patterns may be difficult for the system to recognize.
 - There is excessive background noise, such as wind noise.

VOICE RECOGNITION SYSTEM OPERATION**1.** Press the talk switch.

- After the voice recognition top screen has been displayed, speech guidance will commence.

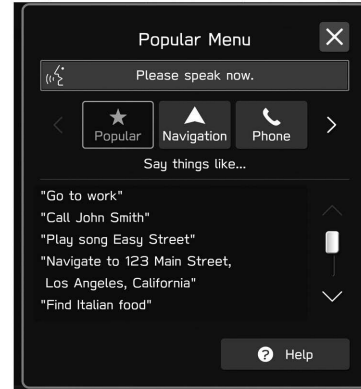
2. Say the command.**▶ 11.6-inch display system/11.6-inch display with Navi system****▶ Dual 7.0-inch display system**

- When selecting **Help** (Help) or saying **"Help"**, all commands supported by the system are listed.
- If a category name is selected, the selected category command list will be displayed.

- To cancel voice recognition, select , or press and hold the talk switch.

NOTE

- Turn the “**VOLUME**” knob, or use the volume control switch on the steering wheel to adjust the speech guidance volume.

COMMAND LIST

Recognizable voice commands and their actions are shown below.

- Frequently used commands are listed in the following tables.
- For devices that are not installed in the vehicle, the related commands will not be displayed in the screen. Also, according to conditions, other commands may not be displayed in the screen.
- The functions available may vary according to the system installed.
- If the system language is changed on the general settings screen, the language of the voice recognition function will also change.
Refer to the vehicle Owner’s Manual for details.

NOTE

- The notations used in the commands are as follows.
 - <○○○>: Numbers, titles, or names to be spoken

► Navigation commands*

*: If equipped

Voice command	Function
Enter an address	Enables setting a destination by saying the address with city and state
Navigate to <address>	Enables setting a destination by saying the address with city and state
Find <POI>	Displays a list of POI category near the current position
Go home	Displays the route to home
Go to work	Displays the route to work
Cancel route	Cancels route guidance
Search favorites	Displays the favorite location
Favorite <favorite name*>	Displays the favorite location
Previous destination	Displays the previous destinations
Delete destination	Cancels route guidance
Show map	Displays the map screen
Find <POI> in a city	Displays a list of POI category near the current position
Change country <country>	Changes a country

Voice command	Function
Navigate to what3words	Enables setting a destination by saying three words hit by "what3words" search.

*: Depending on how the name of a registered favorite is entered, the way it should be spoken when using the voice recognition function will change.

- Lower case letters should be spoken phonetically.
- Upper case letters should be spoken as individual letters.

When speaking the name of registered points, be sure to say it as it is registered.

► Phone commands

Voice command	Function
Call a contact	Places a call to the spoken contact name and phone type of the contact from the phonebook
Call <name> <phone type>	Places a call to the spoken contact name and phone type of the contact from the phonebook
Pair phone	Displays manage devices screen
Send a text by contact	Sends the preset message to the spoken contact name and phone type of the contact from the phonebook
Dial a number	Places a call to the spoken phone number
Dial <number>	Places a call to the spoken phone number
Call back	Places a call to the phone number of the latest incoming call

Voice command	Function
Redial	Places a call to the phone number of the latest outgoing call
Show messages	Displays received text messages
Show recent calls	Displays the call history screen
Send a text to <number>	Sends a text message to the spoken phone number
Send a text by recent calls	Sends a text message by the recent call list
Send a text to <name> <phone type>	Sends a text message to the spoken contact name and phone type of the contact from the phonebook

► Music commands

Voice command	Function
Turn music on	Turns music on
Turn music off	Turns music off
Play song <name>	Plays the selected song
Play artist <name>	Plays tracks from the selected artist
Play playlist <name>	Plays tracks from the selected playlist
FM radio	Switches to FM radio
AM radio	Switches to AM radio
Sirius XM	Switches to SiriusXM® Radio
iPod	Switches to iPod/iPhone
Radio frequency	Tunes radio frequency
Go to a preset	Selects a preset
Channel <name>	Switches to a selected satellite radio channel
Play genre <name>	Plays tracks from the selected genre
Play album <name>	Plays tracks from the selected album

Voice command	Function
Play composer <name>	Plays tracks from the selected composer
Play audiobook <name>	Plays the selected audiobook
Play podcast <name>	Plays the selected podcast
Browse genre <name>	Displays the list of artists of genre
Browse artist <name>	Displays the list of albums of the artist
Browse album <name>	Displays the list of songs of the album
Browse playlist <name>	Displays the list of playlist
Browse composer <name>	Displays the list of albums from the composer
Browse songs	Displays the list of songs
Browse audiobooks	Displays the list of audiobooks
Browse podcasts	Displays the list of podcasts
Auxiliary	Switches source to auxiliary
USB	Switches source to USB

Voice command	Function
Bluetooth audio	Switches source to Bluetooth audio
Tune to <frequency> AM	Tunes AM radio frequency
Tune to <frequency> FM	Tunes FM radio frequency
Tune to FM <frequency> HD <subchannel>	Tunes FM radio frequency
Listen to a radio genre - FM radio -	Selects a radio genre
Listen to a <genre> FM station	Selects a radio genre
Tune to preset <number>	Selects a preset
Tune to channel number	Selects a satellite radio channel
Satellite channel <number>	Selects a satellite radio channel

NOTE

- Depending on the device, your iPod/iPhone may not work when operated via voice recognition.

► Climate commands

Voice command	Function
Auto AC on	Switches on the Auto AC mode on
Warmer	Increases the temperature
Cooler	Decreases the temperature
Increase fan speed	Increases the fan speed
Decrease fan speed	Decreases the fan speed
Set temperature to <temperature>	Sets the temperature to the spoken temperature
Change temperature	Sets the temperature to the spoken temperature
Fan speed	Sets the fan speed to the spoken fan speed

► Apps commands

Voice command	Function
Launch <app name>	Changes screen to selected application
Weather	Changes screen to SiriusXM Travel Link Weather
Weather alert	Changes screen to SiriusXM Travel Link Weather Alerts
Parking	Changes screen to SiriusXM Travel Link Parking
Sports	Changes screen to SiriusXM Travel Link Sports
Go to SUBARU STARLINK	Changes screen to SUBARU STARLINK
Go to CarPlay	Changes screen to Apple CarPlay
Go to Android Auto	Changes screen to Android Auto
Stocks	Changes screen to SiriusXM Travel Link Stocks
Fuel prices	Changes screen to SiriusXM Travel Link Fuel Prices
Show weather for a city	Changes screen to SiriusXM Travel Link Weather
Show weather forecast for <city name>	Changes screen to SiriusXM Travel Link Weather

► Vehicle commands

Voice command	Function
Turn on Auto Start Stop	Turns the Auto Start Stop system on
Turn off Auto Start Stop	Turns the Auto Start Stop system off
Lane Departure Options	Changes the settings of the Lane Departure function
Cruise Control Options	Changes the settings of the Cruise Control function



Appendix/What To Do If/Index



Certification 236

Certification	236
SiriusXM® Radio	236
SiriusXM Data Service	236
Radio Wave Communications	236
Bluetooth	238
iPhone/iPod	238
Apple CarPlay	239
Android Auto	239
Gracenote	239
Others	239

How To Get The Source Code Using The Open Source 240

What To Do If 241

Troubleshooting	241
Troubleshooting Issues Common	
To This System	241
SUBARU STARLINK	241
Radio Operation	242
Phone	243
Updating The System	248
Map Update	249

Index 251

CERTIFICATION

SiriusXM® Radio



- © 2022 Sirius XM Radio Inc. Sirius, XM, SiriusXM and all related marks and logos are trademarks of Sirius XM Radio Inc. All other marks, channel names and logos are the property of their respective owners. All rights reserved.

SiriusXM DATA SERVICE

Neither Sirius XM Radio Inc. nor SUBARU CORPORATION is responsible for any errors or inaccuracies in the SiriusXM data services or its use in vehicle.

RADIO WAVE COMMUNICATIONS

► U.S.A.

- FCC ID: HYQDNNS122
- FCC ID: HYQDNNS127
- This device complies with part 15 of the FCC Rules. Operation is subject to the following two conditions: (1) This device may not cause harmful interference, and (2) this device must accept any interference received, including interference that may cause undesired operation.

⚠ WARNING

● FCC WARNING:

Changes or modifications not expressly approved by the party responsible for compliance could void the user's authority to operate the equipment.

● CAUTION: Radio Frequency Radiation Exposure

This equipment complies with FCC radiation exposure limits set forth for an uncontrolled environment and meets the FCC radio frequency (RF) Exposure Guidelines. This equipment should be installed and operated keeping the radiator at least 20cm or more away from person's body.

● Co-location:

This transmitter must not be co-located or operated in conjunction with any other antenna or transmitter.

► Canada

- This device contains licence-exempt transmitter(s)/receiver(s) that comply with Innovation, Science and Economic Development Canada's licence-exempt RSS(s). Operation is subject to the following two conditions:
 - (1) This device may not cause interference.
 - (2) This device must accept any interference, including interference that may cause undesired operation of the device.

The antenna cannot be removed (and changed) by user.

Co-location: This transmitter must not be co-located or operated in conjunction with any other antenna or transmitter.

L'émetteur/récepteur exempt de licence contenu dans le présent appareil est conforme aux CNR d'Innovation, Sciences et Développement économique Canada applicables aux appareils radio exempts de licence. L'exploitation est autorisée aux deux conditions suivantes :

- (1) L'appareil ne doit pas produire de brouillage;
- (2) L'appareil doit accepter tout brouillage radioélectrique subi, même si le brouillage est susceptible d'en compromettre le fonctionnement.

L'utilisateur n'est pas autorisé à retirer (ou modifier) l'antenne.

Emplacement : Cet émetteur ne doit pas être installé ou utilisé conjointement avec d'autres antennes ou émetteurs.

⚠ WARNING

- CAUTION: Radio Frequency Radiation Exposure

This equipment complies with ISED radiation exposure limits set forth for an uncontrolled environment and meets RSS-102 of the ISED radio frequency (RF) Exposure rules. This equipment should be installed and operated keeping the radiator at least 20 cm or more away from person's body.

ATTENTION: exposition aux radiofréquences

- Cet équipement est conforme aux limites d'exposition aux rayonnements d'ISDE établies pour un environnement non contrôlé ainsi que la norme CNR-102 de la réglementation d'ISDE relative à l'exposition aux radiofréquences (RF). Cet équipement doit être installé et utilisé avec un minimum de 20 cm de distance entre la source de rayonnement et le corps.

Bluetooth

- The Bluetooth® word mark and logos are registered trademarks owned by Bluetooth SIG, Inc. and any use of such marks by SUBARU CORPORATION and DENSO Corporation is under license. Other trademarks and trade names are those of their respective owners.

iPhone/iPod

- Use of the Made for Apple badge means that an accessory has been designed to connect specifically to the Apple product(s) identified in the badge and has been certified by the developer to meet Apple performance standards. Apple is not responsible for the operation of this device or its compliance with safety and regulatory standards.
- Please note that the use of this accessory with an Apple product may affect wireless performance.
- iPhone, iPod, iPod classic, iPod nano, iPod touch, Lightning and App Store are trademarks of Apple Inc., registered in the U.S. and other countries and regions.

Apple CarPlay



- Use of the Apple CarPlay logo means that a vehicle user interface meets Apple performance standards. Apple is not responsible for the operation of this vehicle or its compliance with safety and regulatory standards. Please note that the use of this product with iPhone or iPod may affect wireless performance.
- Apple, iPhone, iPod, iPod touch and Apple CarPlay are trademarks of Apple Inc., registered in the U.S. and other countries and regions.

Android Auto

androidauto

- Android Auto is a trademark of Google LLC.

Gracenote

- Gracenote, the Gracenote logo and logotype are either a registered trademark or a trademark of Gracenote, Inc. in the United States and/or other countries.



OTHERS

- what3words® is a trademark of what3words Limited.
- QR Code is registered trademarks of DENSO WAVE INCORPORATED.
- QR Code est une marque déposée de DENSO WAVE INCORPORATED.
- © 1982-2013, QNX Software Systems Limited. All rights reserved.
- Cinemo is a trademark of Cinemo GmbH, Karlsruhe. Please visit <http://www.cinemo.com>

HOW TO GET THE SOURCE CODE USING THE OPEN SOURCE

This product contains Free/Open Source Software(FOSS).

The license information and/or the source code of such FOSS can be found at the following URL.

<http://www.globaldenso.com/en/opensource/ivi/subaru/>

WHAT TO DO IF

TROUBLESHOOTING

TROUBLESHOOTING ISSUES COMMON TO THIS SYSTEM

Symptom	Cause	Action
The touch screen becomes unresponsive during operation.	An error has occurred in the system.	Press and hold the “VOLUME” knob for 10 seconds or longer to reset the system.
The sound suddenly stops working.		
Only the background is displayed on the screen and no icons appear.		
The sound of radio or connected media stops working.	When Apple CarPlay/Android Auto is used, a smartphone application, such as camera, is operated.	Terminate either Apple CarPlay/Android Auto or the operated smartphone application.

SUBARU STARLINK

► Dual 7.0-inch display system/11.6-inch display system without SUBARU STARLINK Safety and Security only

Symptom	Likely cause	Solution	Page
SUBARU STARLINK does not start.	The time does not match.	Connect your smartphone.	87
		Set the phonebook download function to on.	91

RADIO OPERATION

Symptom	Cause	Action
Mismatch of time alignment- a user may hear a short period of programming replayed or an echo, stutter or skip.	The radio stations analog and digital volume is not properly aligned or the station is in ballgame mode.	None, radio broadcast issue. A user can contact the radio station.
Sound fades, blending in and out.	Radio is shifting between analog and digital audio.	Reception issue, may clear-up as the vehicle continues to be driven. Turning the indicator of the HD Radio button off can force radio in an analog audio.
Audio mute condition when an HD2/HD3 multicast channel had been playing.	The radio does not have access to digital signals at the moment.	This is normal behavior, wait until the digital signal returns. If out of the coverage area, seek a new station.
Audio mute delay when selecting an HD2/HD3 multicast channel preset.	The digital multicast content is not available until HD Radio™ broadcast can be decoded and make the audio available. This takes up to 7 seconds.	This is normal behavior, wait for the audio to become available.
Text information does not match the present song audio.	Data service issue by the radio broadcaster.	Broadcaster should be notified.
No text information shown for the present selected frequency.	Data service issue by the radio broadcaster.	Broadcaster should be notified.

PHONE

If there is a problem with the hands-free system or a Bluetooth phone, first check the table below.

► When using the hands-free system with a Bluetooth phone

Symptom	Likely cause	Solution	Page	
			Cellular phone	This system
The hands-free system or Bluetooth phone does not work.	The connected Bluetooth phone may not be a compatible Bluetooth cellular phone.	For a list of specific Bluetooth phones which operation has been confirmed on this system. For USA customers, please visit www.subaru.com for details. Outside of the USA customers, contact your local dealer to arrange a demonstration in order to confirm whether or not the phone can be paired with the vehicle.	*	81
	The Bluetooth version of the connected cellular phone may be older than the specified version.	Use a cellular phone with Bluetooth version 2.1 or higher. Recommended: Ver. 5.0* ¹ /Ver. 4.2* ² or higher	*	81

*: For details, refer to the owner's manual that came with the cellular phone.

*1: 11.6-inch display system/11.6-inch display with Navi system

*2: Dual 7.0-inch display system

► When registering/connecting a cellular phone

Symptom	Likely cause	Solution	Page	
			Cellular phone	This system
A cellular phone cannot be registered.	An incorrect passcode was entered on the cellular phone.	Enter the correct passcode on the cellular phone.	*	-
	The registration operation has not been completed on the cellular phone side.	Complete the registration operation on the cellular phone (approve registration on the phone).	*	-
	Old registration information remains on either this system or the cellular phone.	Delete the existing registration information from both this system and the cellular phone, then register the cellular phone you wish to connect to this system.	*	90
A Bluetooth connection cannot be made.	Another Bluetooth phone is already connected.	Manually connect the cellular phone you wish to use to this system.	-	87
	Bluetooth function is not enabled on the cellular phone.	Enable the Bluetooth function on the cellular phone.	*	-

*: For details, refer to the owner's manual that came with the cellular phone.

► When making/receiving a call

Symptom	Likely cause	Solution	Page	
			Cellular phone	This system
A call cannot be made/received.	Your vehicle is in a "No Service" area.	Move into the service area.	-	-

► When using the phonebook

Symptom	Likely cause	Solution	Page	
			Cellular phone	This system
Phonebook data cannot be transferred automatically.	The profile version of the connected cellular phone may not be compatible with transferring phonebook data.	For a list of specific Bluetooth phones which operation has been confirmed on this system. For USA customers, please visit www.subaru.com for details. Outside of the USA customers, contact your local dealer to arrange a demonstration in order to confirm whether or not the phone can be paired with the vehicle.	*	81
	Automatic contact transfer function on this system is set to off.	Set automatic contact transfer function on this system to on.	-	91

*: For details, refer to the owner's manual that came with the cellular phone.

► When using the Bluetooth message function

Symptom	Likely cause	Solution	Page	
			Cellular phone	This system
Messages cannot be viewed.	Message transfer is not enabled on the cellular phone.	Enable message transfer on the cellular phone (approve message transfer on the phone).	*	-

*: For details, refer to the owner's manual that came with the cellular phone.

► In other situations

Symptom	Likely cause	Solution	Page	
			Cellular phone	This system
Even though all conceivable measures have been taken, the symptom status does not change.	The cellular phone is not close enough to this system.	Bring the cellular phone closer to this system.	-	-
	The cellular phone is the most likely cause of the symptom.	Turn the cellular phone off, remove and reinstall the battery pack, and then restart the cellular phone.	*	-
		Enable the cellular phone's Bluetooth connection.	*	-
		Stop the cellular phone's security software and close all applications.	*	-
		Before using an application installed on the cellular phone, carefully check its source and how its operation might affect this system.	*	-

*: For details, refer to the owner's manual that came with the cellular phone.

UPDATING THE SYSTEM

If a problem occurs when attempting to perform a system update, refer to the following table.

Symptom	Cause	Solution
"No server response." is displayed and software cannot be downloaded.	The vehicle may be in an area having weak communication signals.	Move the vehicle to an area where communication signals can be received normally. If it is still not possible to download, contact your SUBARU dealer.
	An error occurred at the server. (Server cannot respond temporarily due to maintenance, etc.)	Wait for the server to return to normal. If it is still not possible to download, contact your SUBARU dealer.
"The software install failed." is displayed.	Software installation may have failed or an error of unidentified cause may have occurred.	Contact your SUBARU dealer.

MAP UPDATE (IF EQUIPPED)

If a problem occurs when attempting to perform a map update, refer to the following table.

► Errors when updating via USB

Error code	Cause	Solution
"Installation Failed (1)"	Reading of the data on the USB memory device failed.	Disconnect and then reconnect the USB memory device, check that it is connected correctly, and attempt to perform the update again.
"Installation Failed (2)"	Corruption of the data on the USB memory device was detected.	Attempt to perform the update again. If the same error is detected, download the map update data again, copy it to a different USB memory device and attempt to perform the update again.
"Installation Failed (5)"	An error in the system data was detected while performing the update.	Attempt to perform the update again. If the same error is detected, download the map update data again, copy it to a different USB memory device and attempt to perform the update again.
"Installation Failed (X)"	An unspecified error has occurred.	Attempt to perform the update again. If the same error is detected, contact your SUBARU dealer.

► Errors when updating via Wi-Fi®, smartphone

Error code	Cause	Solution
#6	Communication failure with server	Move to a place where communication status is good and then attempt to perform the update again.
404	The system ID number of the center information display is not registered to the server.	Contact your SUBARU dealer.
XXX (Three-digit numeral/ code)	An error occurred with the connected server.	Wait for a while and then attempt to perform the update again. If the update procedure fails again, contact your SUBARU dealer.

INDEX

A

AM radio	157
Android Auto	137
Apple CarPlay	133
AUX	177

B

Bluetooth	80
Profiles	81
Registering Bluetooth device	80
Bluetooth audio	173
Bluetooth phone message	117

C

Calling on Bluetooth phone	110
By contacts list	112
By favorites list	111
By keypad	112
By recent calls list	110
Command list	228

D

Destination search	201
Driver profile	25, 48

E

Entering letters, numbers/list screen	72
Entering letters/numbers	72
List screen operation	74

F

Favorites settings	203
FM radio	157

G

General settings	92
GPS	217
Limitations	217

H

Hands-free system	106
Home screen operation	76
Adding shortcut icons	76
Moving/deleting shortcut icons	77

I

Initial screen	68
iPod/iPhone	170

M

Map data	219
Update	219
Map screen information	197
Map screen operation	193
Current position display	193
Map scale	194
Orientation of the map	195
Media operation	168
AUX	177
Bluetooth audio	173
iPod/iPhone	170
USB memory	168
Memory points settings	203

N

Navigation settings	215
---------------------------	-----

P

Phone settings	83
----------------------	----

R

Radio operation	157
AM/FM radio	157
SiriusXM® radio	163
Receiving on Bluetooth phone	113
Incoming calls	113
Route guidance	208
Route related functions	206, 211

S

Screen adjustment	75
Adjusting brightness	75
Day and night mode	75
Search operation	201
Setting	79
General	92
Navigation	215
Phone	83
Radio	100
Sound	98
SiriusXM® radio	163
SiriusXM Travel Link	141
Sound settings	98
Status display	75
Steering wheel controls	184
SUBARU STARLINK	127

T

Talking on Bluetooth phone	114
Touch screen gestures	70
Touch screen operation	71
Traffic information	197
Troubleshooting	241
Typical voice guidance prompts	214

U

USB memory	168
------------------	-----

V

Voice recognition system	226
--------------------------------	-----

