

Foreword

Congratulations on choosing a SUBARU vehicle equipped with EyeSight™. EyeSight incorporates the latest driver assistance features available from SUBARU, including such features as Adaptive Cruise Control, a Lead Vehicle Start Alert and a Lane Departure and Lane Sway Warning, all of which are designed to assist the driver in making decisions and increase driver comfort and convenience. Initially, the operation and use of the various EyeSight features may be unfamiliar to you. That is why we urge you to read this manual carefully before using EyeSight. We also recommend that you first take the time to test EyeSight in order to experience its features for yourself so that you can become familiar with their operation.

Please keep in mind that it is the responsibility of drivers to operate their vehicles safely at all times. Drivers should always remain alert and should never become complacent while operating their vehicles because of the presence of EyeSight. EyeSight is never a substitute for active driver involvement and it may not operate optimally under all driving conditions.

This booklet is a supplement to the Owner's Manual for your SUBARU vehicle and contains a detailed description of EyeSight. It should be read in conjunction with your Owner's Manual so that you will gain a thorough understanding of the proper operation of your vehicle.

The information, specifications and illustrations found in this booklet are those in effect at the time of printing. SUBARU CORPORATION reserves the right to change specifications and designs at any time without prior notice and without incurring any obligation to make the same or similar changes on vehicles previously sold.

Please keep this booklet together with your Owner's Manual and leave it in the vehicle at the time of resale. The next owner will need the information it contains.

SUBARU CORPORATION, TOKYO, JAPAN

"SUBARU" and the six-star cluster design are registered trademarks of SUBARU CORPORATION.

© Copyright 2022 SUBARU CORPORATION

EyeSight

About EyeSight	4
Pre-Collision Braking System.....	28
Adaptive Cruise Control	43
Lane Keep Assist	69
Pre-Collision Throttle Management.....	78
Lane Departure Warning	84
Lane Sway Warning	88
Lead Vehicle Start Alert	91
Driver Assist indicator	93
Conventional Cruise Control	94
List of alert/notification sounds.....	106
EyeSight malfunction and temporary stop	108
Customizing functions	111
Message screen list	114
Troubleshooting	117

About EyeSight

EyeSight is a driving support system that uses a range of functions to assist the driver in making decisions in order to provide for more safe and comfortable driving and to reduce driver fatigue. Making use of images created by the stereo camera specially designed by SUBARU, EyeSight detects the vehicle in front, obstacles, traffic lanes and other items.



WARNING

Drivers are responsible for driving safely. Always comply with all traffic rules and regulations regardless of the fact that your vehicle is equipped with EyeSight. Always maintain a safe following distance between your vehicle and the vehicle in front of you, pay attention to your surroundings and driving conditions, and take necessary actions in order to maintain a safe following distance.

Never attempt to drive relying on EyeSight alone.

EyeSight is intended to assist the driver in making decisions in order to reduce the risk of accidents or damage and lessen the burden on the driver.

When an EyeSight warning is activated, pay attention to what is in front of you and to your surroundings, and take necessary actions.

This system is not designed to support driving in poor visibility or in extreme weather conditions, or to protect against careless driving when the driver is not paying complete attention to the road ahead. It also cannot prevent collisions from occurring in all driving conditions. There are limits to the EyeSight recognition performance and control performance. Be sure to read the instructions for each function before using the system, and always use it properly. Improper use may lead to failure of control performance, which could cause an accident.

Refer to the following pages for each function:

- For Pre-Collision Braking System, refer to page 28.
- For Adaptive Cruise Control, refer to page 43.
- For Lane Keep Assist, refer to page 69.
- For Pre-Collision Throttle Management, refer to page 78.
- For Lane Departure Warning, refer to page 84.
- For Lane Sway Warning, refer to page 88.
- For Lead Vehicle Start Alert, refer to page 91.
- For Conventional Cruise Control, refer to page 94.

The EyeSight system in your vehicle is designed for use in countries in which traffic drives on the right-hand side of the road. EyeSight for left-hand drive vehicles such as yours is not designed for use in countries in which vehicles are driven on the left-hand side of the road.

- The system may not operate correctly under the conditions listed below. When these conditions occur, turn off Pre-Collision Braking System. Also, do not use Adaptive Cruise Control, Lane Keep Assist or Conventional Cruise Control.
 - The tire pressure is not correct.*¹
 - The temporary spare tire is installed.*¹
 - Tires that are unevenly worn or tires with uneven wear patterns are installed.*¹
 - Tires that are the wrong size are installed.*¹
 - A flat tire has been fixed temporarily with a tire repair kit.
 - The suspension has been modified (including a genuine SUBARU suspension that has been modified).
 - An object that obstructs the stereo camera's view is installed on the vehicle.
 - Tire chains are installed.
 - The headlights are dirty or they have snow and ice or dirt on them. (Objects are not correctly illuminated and are difficult to detect.)
 - The optical axes are not aligned correctly. (Objects are not correctly illuminated and are difficult to detect.)
 - The lights including headlights and fog lights have been modified.
 - Vehicle operation has become unstable due to an accident or malfunction.
 - The brake system warning light is illuminated in red.*²
 - A heavy cargo is loaded onto or inside the vehicle.
 - The maximum number of occupants is exceeded.
 - The combination meter is not operating properly; such as when the lights do not illuminate, the beeps do not sound, the display is different from when it is normal, etc.*³

Continued on next page ⇒

⇒ Continued from previous page

- The system will not operate correctly in the following conditions. Do not use Adaptive Cruise Control, Lane Keep Assist or Conventional Cruise Control.
 - The wheels are out of balance (e.g., the balance weight is removed or misaligned).^{*1}
 - The wheels are out of alignment.^{*1}
 - A trailer or another vehicle, etc. is being towed.
- The system may not operate properly under the following conditions. Do not use Lane Keep Assist.

- There is an abnormal vibration in the steering wheel or the steering wheel is heavier than usual.

- The steering wheel has been replaced with parts other than genuine SUBARU parts.

*1: The wheels and tires have functions that are critically important. Be sure to use the correct ones. For details, refer to the vehicle Owner's Manual.

*2: If the brake system warning light does not turn off, immediately pull the vehicle over in a safe place and contact a SUBARU dealer to have the system inspected. For details, refer to the vehicle Owner's Manual.

*3: For details about the combination meter, refer to the vehicle Owner's Manual.

CAUTION

- The characteristics of the stereo camera are similar to those of human eyes. For this reason, conditions that make it difficult for the driver to see in the forward direction have the same effect on the stereo camera. They also make it difficult for the system to detect vehicles, obstacles, and traffic lanes.
- Detection by the EyeSight system is limited to objects that are within the range of the stereo camera's field of view. Also, after an object enters the range of the camera's field of view, it may take some time for the system to detect it as a target obstacle and to warn the driver.

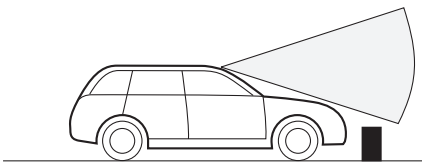

Low objects surrounding the vehicle cannot be detected.

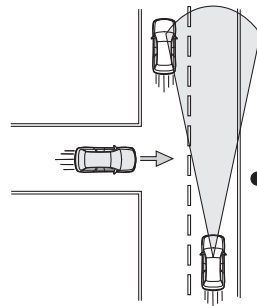

S03873

- Under the conditions listed below, it will become more difficult for the system to detect the vehicle in front, motorcycles, bicycles, pedestrians and obstacles on the road, and lane markers. Also, EyeSight may temporarily stop operating. However, the temporary stop will be canceled once these conditions have improved and the vehicle is driven for a short period of time.
 - Bad weather (for example heavy rain, a blizzard or thick fog). In particular, the system is more likely to temporarily stop operating when there is an oil film adhering to the windshield, a glass coating has been applied, or poorly performing wipers are used.
 - Strong light is coming from the front (sunlight or headlight beams of oncoming traffic, etc.).
 - The windshield washer is in use.
 - Raindrops, water drops, or dirt on the windshield are not wiped off sufficiently.
 - The windshield has become fogged, scratched or smeared, or snow, dirt, dust or frost has adhered to it, or it is otherwise affected. These will reduce the stereo camera's field of view. Also, light is reflecting off the dirt, etc.

Continued on next page ⇒

⇒ Continued from previous page

- The vehicle is tilted at an extreme angle due to loaded cargo or other factors.
- Visibility is poor due to sand, smoke or water vapor blowing in the wind, or the front vision is obscured due to water splashes, snow, dirt or dust stirred up generated by the vehicle in front or oncoming traffic.
- The stereo camera's field of view is obstructed (for example by a canoe on the roof of the vehicle).
- Through the entrance or exit of a tunnel
- The rear aspect of the vehicle in front is low, small or irregular (for example a low bed trailer, etc.).
- The obstacle is a fence, a wall or a shutter, etc. with a uniform pattern (a striped pattern, brick, etc.) or with no pattern in front.
- The obstacle is a wall or door made of glass or a mirror in front.
- Driving at night or in a tunnel when there is a vehicle in front that does not have its taillights on
- Driving through a banner or flag, low branches on a tree or thick/tall vegetation
- On steep uphill or downhill grades
- The stereo camera is obstructed by a hand, etc. (If even one of the lenses is obstructed, the system does not operate properly.)
- It is completely dark and no objects are detected.
- The area around the vehicle has a uniform color (such as when completely covered in snow, etc.).
- Accurate detection is not possible due to reflections in the windshield.
- Under the conditions listed below, EyeSight may temporarily stop operating. If this occurs, EyeSight will resume operating when the conditions improve.
 - The temperature inside the vehicle is high, such as after the vehicle was left in bright sunshine, or the temperature inside the vehicle is low, such as after the vehicle was left in an extremely cold environment.
 - Immediately after the hybrid system starts.
- Under the conditions listed below, it is difficult to recognize vehicles in front, motorcycles, pedestrians, obstacles on the road, traffic lanes, etc. Also, the EyeSight system may temporarily stop operating. If the EyeSight system repeatedly stops operating several times, contact a SUBARU dealer and have the system inspected.
 - The stereo camera lenses are smeared such as from fingerprints.
 - The stereo camera has become misaligned due to a strong impact.

- When there is a malfunction in the EyeSight system, turn off Pre-Collision Braking System (⇒ page 41) and Lane Departure Warning (⇒ page 86), and stop using Adaptive Cruise Control, Lane Keep Assist and Conventional Cruise Control. Contact a SUBARU dealer and have the system inspected.
- When the Vehicle Dynamics Control warning light is illuminated, Pre-Collision Braking System may not operate properly. If the warning light is illuminated, turn off Pre-Collision Braking System. Also, do not use Adaptive Cruise Control or Conventional Cruise Control.



NOTE

- EyeSight records and stores the following data when Pre-Collision Braking System is operated. It does not record conversations or other audio data.
 - Stereo camera image data
 - Distance from the vehicle in front
 - Vehicle speed
 - Steering wheel turning angle
 - Lateral movement with regards to the direction of travel
 - Accelerator pedal operation status
 - Brake pedal operation status
 - Select lever position
 - Odometer reading
 - Data related to ABS, Vehicle Dynamics Control and Traction Control Function
- SUBARU and third parties contracted by SUBARU may acquire and use the recorded data for the purpose of vehicle research and development. SUBARU and third parties contracted by SUBARU will not disclose or provide the acquired data to any other third party except under the following conditions.
 - The vehicle owner has given his/her consent.
 - The disclosure/provision is based on a court order or other legally enforceable request.
 - Data that has been modified so that the user and vehicle cannot be identified is provided to a research institution for statistical processing or similar purposes.

Handling of the Stereo Camera

The stereo camera is located on the front map lights unit.

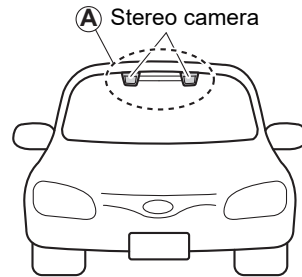

S01107

CAUTION

- The stereo camera monitors and detects smears or blurs on the front of the camera. However, detection is not 100% accurate. Under certain conditions, the function may fail to detect smears or blurs on the front of the stereo camera accurately. In addition, this function may not detect that there is snow or ice on the windshield close to the stereo camera. In such conditions, be sure to keep the windshield clean at all times (indicated by ). Otherwise the system may not operate correctly. When this function detects that the front of the stereo camera is smeared or blurred, no EyeSight functions can be activated except for Conventional Cruise Control.
- The stereo camera lenses are precision components. Always observe the following precautions especially when handling them.
 - Never touch the stereo camera lenses, and do not attempt to wipe or clean the lenses. Doing so could damage or soil the lens, and lead to improper system performance.
If you ever touch a lens for any reason, be sure to contact a SUBARU dealer.

- When cleaning the windshield, cover the front of the camera casing with paper that does not collect dust, such as copy paper. Affix the paper to prevent glass cleaner from getting on the camera lenses. At this point, make sure that the tape's adhesive surface does not come in contact with the windshield or the lens. Be sure to remove the paper after cleaning.

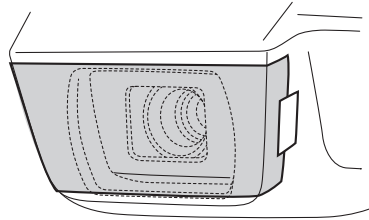

S01097

- When having the inside of windshield cleaned at a service station, etc., be sure to request that the attendant covers the camera covers before washing the vehicle.
- Do not subject the stereo camera to a strong impact.
- Do not remove or disassemble the stereo camera.
- Do not change the positions where the stereo camera is installed or modify any of the surrounding structures.
- Do not install an interior rearview mirror other than a genuine SUBARU rearview mirror (such as a wide-type mirror) and the sun visor. Also, use the rearview mirror so that it does not obstruct the stereo camera. Failure to do so may affect the stereo camera's field of view and could prevent the EyeSight system from functioning properly.

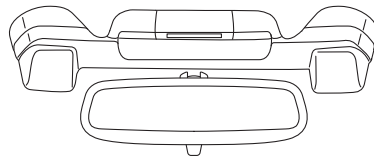
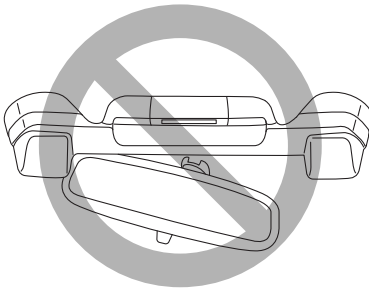

S00509

Continued on next page ⇒

⇒ Continued from previous page

- Do not install any accessories other than the ones designated by SUBARU on the prohibited areas shown in the illustrations (gray zones). Even if some accessories are installed on the outside of the prohibited areas, abnormal operation of EyeSight may occur due to the reflection of the light or any objects. In this situation, move the accessories. For details, contact a SUBARU dealer.

Side view

Front view

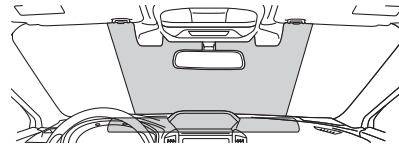
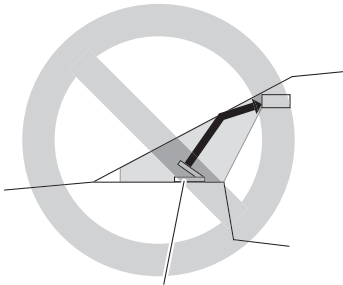

Monitors or other accessories

S03874

- Do not place any objects on top of the instrument panel. The stereo camera may not be able to detect objects accurately and the EyeSight system may not function properly due to reflections in the windshield. For details, contact a SUBARU dealer.
- If the top of the instrument panel is polished with chemicals or other substances, the stereo camera may not be able to detect objects accurately and the EyeSight system may not operate properly due to reflections in the windshield.
- Do not install any wiper blades other than genuine SUBARU wiper blades. Doing so may affect the stereo camera's field of view and could prevent the EyeSight system from functioning properly.
- Replace damaged wiper blades or worn wiper blade rubbers as soon as possible. Using damaged wiper blades or worn wiper blade rubbers may cause streaking on the windshield. The stereo camera may not be able to detect objects accurately and the EyeSight system may not function properly due to streaks or droplets remaining on the windshield.

- Do not install any accessories on the front side such as on the hood or the grille. It may affect the camera view and the system may not operate correctly.
- Make sure that the cargo loaded on the roof does not interfere in the stereo camera's field of view. Obstructing the stereo camera's view may impair the system operation. For details, contact a SUBARU dealer.

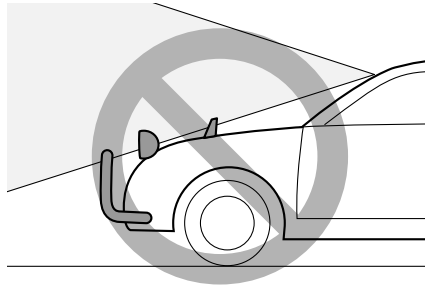

S01098

- Keep the windshield (outside and inside) clean at all times. When the windshield has become fogged, or it has a dirt or an oil film on it, the stereo camera may not detect objects accurately and the EyeSight system may not operate correctly. Never mount any device to the center air vent, as any air-flow change may impact EyeSight performance.
- Do not place any stickers or accessories on the windshield (outside or inside). If you have to do so (for example, legally required or electronic toll tag), avoid the area directly in front of the camera. Otherwise, it may adversely affect the field of view of the stereo camera and can cause improper operation of the system. For details, contact a SUBARU dealer.
- Do not use any glass coating agents or similar substances on the windshield. Doing so may interfere with the proper operation of the system.
- Do not install any film or an additional layer of glass on the windshield. The system may not operate correctly.
- If there are scratches or cracks on the windshield, contact a SUBARU dealer.
- To have the windshield replaced or repaired, contact a SUBARU dealer. Do not install a windshield other than a genuine SUBARU windshield. The stereo camera may not be able to detect objects accurately and the EyeSight system may not operate properly.

EyeSight Functions

EyeSight includes the following functions.

■ Pre-Collision Braking System

This function uses a following distance warning feature to warn the driver to take evasive action when there is the possibility of a collision with a vehicle or obstacle in front of you. If the driver does not take evasive action, the brakes are applied automatically to help reduce vehicle collision damage or, if possible, help prevent a collision.

⇒ Page 28

■ Adaptive Cruise Control

This function maintains the set vehicle speed and when there is a vehicle in front in the same traffic lane, it follows the speed of the vehicle in front up to the maximum of the set vehicle speed.

⇒ Page 43

■ Lane Keep Assist

This function helps suppress lane drifting by detecting lane markings (e.g., white lines) on highways and roads, and by assisting steering operation.

⇒ Page 69

■ Pre-Collision Throttle Management

This function reduces accidental forward movement caused by the select lever being placed in the wrong position or the accelerator pedal being accidentally depressed, or depressed too strongly.

⇒ Page 78

■ Lane Departure Warning

This function warns the driver when the vehicle is about to drift off the road.

⇒ Page 84

■ Lane Sway Warning

This function warns the driver when it detects vehicle drifting caused by driver fatigue, failure to concentrate on the road, inattention, strong crosswinds or other factors.

⇒ Page 88

■ Lead Vehicle Start Alert

This function notifies the driver when the vehicle stopped in front starts moving but the driver's vehicle remains stationary.

⇒ Page 91

■ Conventional Cruise Control

In this mode, the system maintains a constant vehicle speed. It does not follow the vehicle in front. This function can be used even when the EyeSight system has temporarily stopped operating (⇒ page 109). This function is used by switching from Adaptive Cruise Control to Conventional Cruise Control.

⇒ Page 94



NOTE

EyeSight does not operate when the hybrid system is not running (Hybrid READY indicator light turns off).



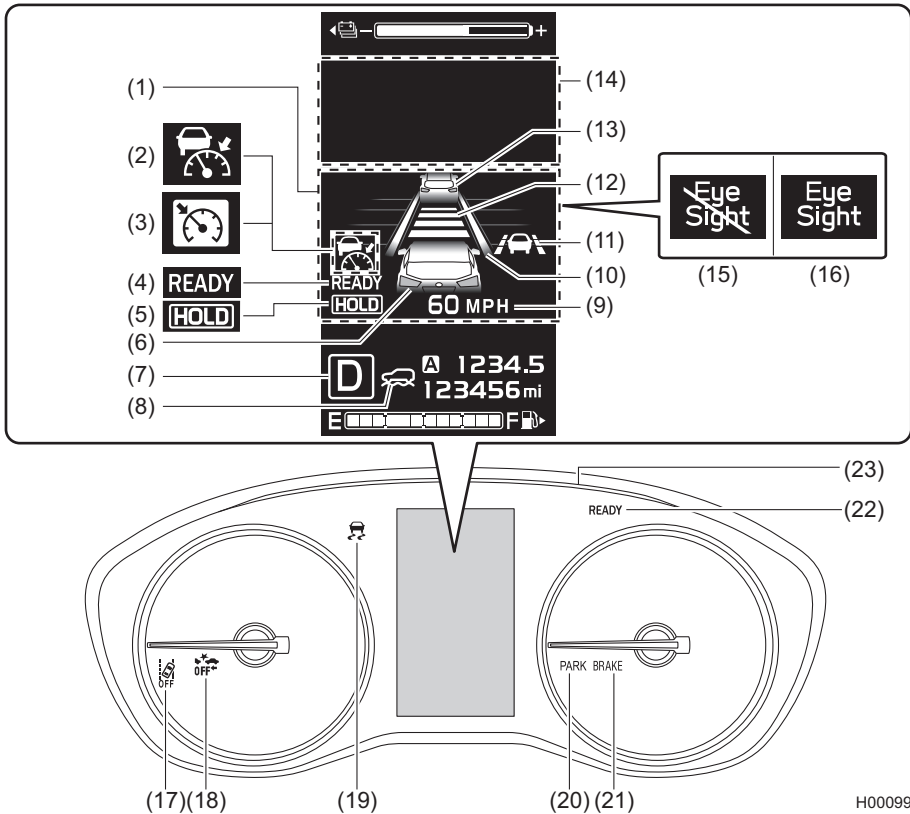







Instrument panel display layout



















H00099





Display units can be changed in the Screen Settings. For details, refer to the vehicle Owner's Manual.

- | | |
|---|---|
| (1) EyeSight display area | (14) Warning screen area |
| (2) Adaptive Cruise Control indicator | (15) EyeSight temporary stop indicator (white) |
| (3) Conventional Cruise Control indicator | (16) EyeSight warning indicator (yellow) |
| (4) READY indicator | (17) Lane Departure Warning OFF indicator light |
| (5) HOLD indicator | (18) Pre-Collision Braking System OFF indicator light |
| (6) Your vehicle indicator | (19) Vehicle Dynamics Control warning light |
| (7) Select lever indicator | (20) Electronic parking brake indicator light |
| (8) X-MODE indicator | (21) Brake system warning light |
| (9) Set vehicle speed | (22) Hybrid READY indicator light |
| (10) Lane indicator | (23) Driver Assist indicator |
| (11) Lane Keep Assist indicator | |
| (12) Following distance setting indicator | |
| (13) Lead vehicle indicator | |

	<p>Adaptive Cruise Control indicator</p> <ul style="list-style-type: none"> • This indicator illuminates when the  (CRUISE) switch is pressed. ⇒ Page 51 • When Adaptive Cruise Control is activated, this indicator changes from white to green. When the driver accelerates the vehicle by depressing the accelerator pedal while Adaptive Cruise Control is operating, the indicator changes from green to white. ⇒ Page 52
	<p>Conventional Cruise Control indicator</p> <ul style="list-style-type: none"> • This indicator illuminates when the  /  (Following distance setting) switch is pressed and held after pressing the  (CRUISE) switch. ⇒ Page 96 • This indicator changes from white to green when Conventional Cruise Control is activated. ⇒ Page 98
	<p>READY indicator</p> <p> illuminates when cruise control* can be activated. ⇒ Pages 51 and 97</p> <p>*: Adaptive Cruise Control and Conventional Cruise Control</p>
	<p>HOLD indicator</p> <p> illuminates when the stay-stopped function is operated while Adaptive Cruise Control is on. ⇒ Page 60</p>
	<p>Lead vehicle indicator</p> <p>When Adaptive Cruise Control is activated or when the stay-stopped function is engaged, this indicator illuminates when a vehicle in front has been detected. ⇒ Page 53</p>

	<p>Following distance setting indicator</p> <p>Indicates the following distance setting that was set with the  /  (Following distance setting) switch.</p> <p>⇒ Page 59</p>
	<p>Set vehicle speed</p> <p>Displays the set vehicle speed.</p> <p>⇒ Pages 51 and 96</p>
	<p>Select lever indicator</p> <p>This indicator illuminates and shows which position the select lever is in.</p>
	<p>EyeSight warning indicator (yellow)</p> <ul style="list-style-type: none"> • This indicator illuminates or blinks when a malfunction occurs in the EyeSight system. • When it is illuminated or blinking, none of the EyeSight functions can be used (including Adaptive Cruise Control and Pre-Collision Braking System, etc.). <p>⇒ Page 108</p>
	<p>EyeSight temporary stop indicator (white)</p> <ul style="list-style-type: none"> • This indicator illuminates when the EyeSight system is temporarily stopped. • When the ignition switch is turned to the ON position, this indicator will illuminate if the  (CRUISE) switch or the  (Lane Keep Assist) switch is set to ON within approximately 7 seconds of the hybrid system starting. It turns off approximately 7 seconds after the hybrid system starts. • When it is illuminated, none of the EyeSight functions can be used except for Conventional Cruise Control. <p>⇒ Page 109</p>
	<p>X-MODE indicator</p> <p>This indicator illuminates when the X-MODE is on.</p> <p>⇒ Refer to the vehicle Owner's Manual for details.</p>



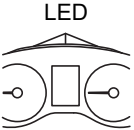

	<p>Lane Departure Warning OFF indicator light</p> <ul style="list-style-type: none"> • This indicator light illuminates when Lane Departure Warning and Lane Sway Warning are off. • It also illuminates when the ignition switch is turned to the ON position. Approximately 7 seconds after the hybrid system starts, the Lane Departure Warning OFF indicator light will turn off or remain illuminated depending on the current status (ON or OFF). <p>⇒ Page 87</p>
	<p>Pre-Collision Braking System OFF indicator light</p> <ul style="list-style-type: none"> • This indicator light illuminates when Pre-Collision Braking System and Pre-Collision Throttle Management are off. • It also illuminates when the ignition switch is turned to the ON position, and then turns off approximately 7 seconds after the hybrid system starts. <p>⇒ Page 42</p>
	<p>Lane indicator</p> <p>This indicator illuminates in gray when the  (Lane Keep Assist) switch is pressed. When Lane Keep Assist is operational or operating, this indicator illuminates in white.</p> <p>⇒ Page 74</p>
<p>BRAKE / </p>	<p>Brake system warning light</p> <p>If the brake system warning light illuminates when the electronic parking brake is released while driving, turn Pre-Collision Braking System off. At this time, do not use Adaptive Cruise Control or Conventional Cruise Control.</p> <p>If the brake system warning light does not turn off, immediately pull the vehicle over in a safe place and contact a SUBARU dealer to have the system inspected.</p> <p>⇒ Refer to the vehicle Owner's Manual for details.</p>
<p>PARK / </p>	<p>Electronic parking brake indicator light</p> <p>This indicator light illuminates when the electronic parking brake is applied.</p> <p>⇒ Refer to the vehicle Owner's Manual for details.</p>

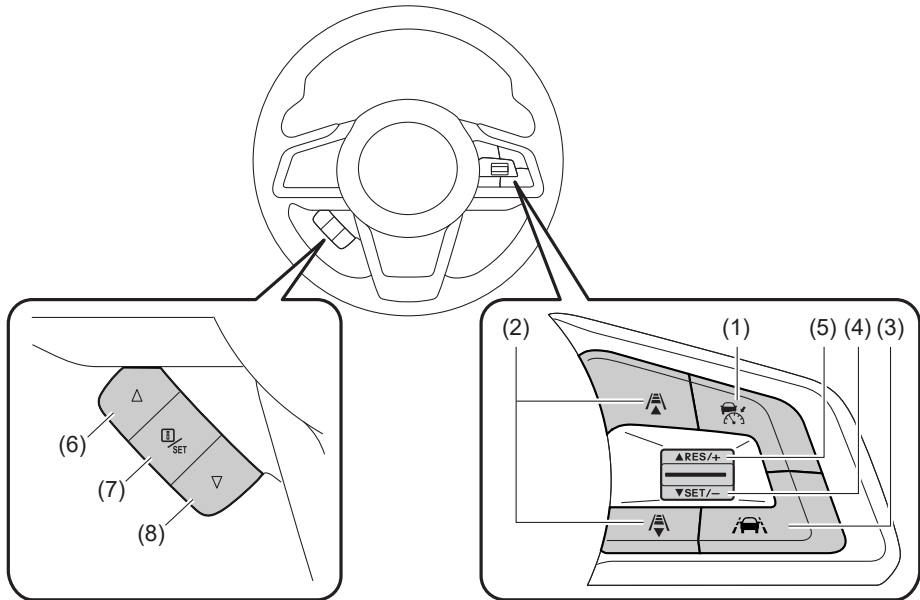

	<p>Your vehicle indicator</p> <p>When the brake pedal is depressed or the brake control function is activated, the brake lights on the vehicle indicator illuminate in red.</p>
	<p>Lane Keep Assist indicator</p> <ul style="list-style-type: none"> • This indicator illuminates when Lane Keep Assist is turned on by pressing the  (Lane Keep Assist) switch. • While the Lane Keep Assist system is activated, if the vehicle travels across a lane marker, the indicator changes from white to green. <p>⇒ Page 74</p>
	<p>Vehicle Dynamics Control warning light</p> <p>This warning light illuminates when the ignition switch is turned to the ON position, and turns off approximately 2 seconds after the hybrid system is started. It will illuminate if there is a malfunction in the Vehicle Dynamics Control electrical control system.</p> <p>⇒ Refer to the vehicle Owner's Manual for details.</p>
<p>READY</p>	<p>Hybrid READY indicator light</p> <p>This indicator light illuminates when the hybrid system has started. It turns off when the hybrid system has been turned off.</p> <p>⇒ Refer to the vehicle Owner's Manual for details.</p>
	<p>Driver Assist indicator</p> <p>This indicator illuminates for approximately 5 seconds after switching to Hybrid Battery Save Mode or Hybrid Battery Charge Mode. It also blinks slowly when charging from an external power supply is in progress.</p> <p>Blinking and illumination of this indicator are also linked to the EyeSight functions.</p> <p>⇒ Page 93</p>

Switch layout





S02653

- (1)  (CRUISE) switch
- (2)  /  (Following distance setting) switches
- (3)  (Lane Keep Assist) switch
- (4) SET/- switch

- (5) RES/+ switch
- (6)  switch
- (7)  (Info)/SET switch
- (8)  switch

■ (CRUISE) switch

- Press this switch to turn cruise control* on/off.
 - When  (Adaptive Cruise Control indicator) or  (Conventional Cruise Control indicator) is shown on the EyeSight display area, this indicates that the main cruise control is on.
 - ⇒ Pages 51 and 96
 - Press this switch to cancel the cruise control.
 - ⇒ Pages 63 and 101
- *: Adaptive Cruise Control and Conventional Cruise Control

■ RES/SET switch



● SET/-

- Press this switch to set cruise control*.
 - Press this switch to reduce the set vehicle speed (when cruise control* is currently set).
 - ⇒ Pages 52 and 57 (for Adaptive Cruise Control)
 - ⇒ Pages 98 and 100 (for Conventional Cruise Control)
- *: Adaptive Cruise Control and Conventional Cruise Control

● RES/+

- Press this switch to set cruise control*.
 - After cruise control* is canceled, press this switch to resume the cruise control function at the vehicle speed that was previously set.
 - Press this switch to increase set vehicle speed (when cruise control* is currently set).
 - ⇒ Pages 52, 56 and 66 (for Adaptive Cruise Control)
 - ⇒ Pages 98, 99 and 104 (for Conventional Cruise Control)
- *: Adaptive Cruise Control and Conventional Cruise Control

■ / (Following distance setting) switches

- Press either of these switches to select the set following distance in 4 stages (only when Adaptive Cruise Control is on).
⇒ Page 59
 - When the main cruise control is on, switching between Adaptive Cruise Control and Conventional Cruise Control is possible by pressing the  /  (Following distance setting) switch*.
- *: To switch to Conventional Cruise Control, press and hold the switch for approximately 2 seconds or longer.

■ (Lane Keep Assist) switch

Press this switch to turn Lane Keep Assist on/off.

⇒ Page 74

■ switch / switch

Pull either of these switches in the following situations.

- When switching the screen displayed on the combination meter display.
- When changing the Warning Volume settings, etc.

⇒ Page 111

■ (Info)/SET switch

Pull this switch in the following situations.

- When displaying the message that appeared in the warning screen area again.
⇒ Page 114
- When changing the Warning Volume settings, etc.
⇒ Page 111

■ (Pre-Collision Braking System OFF) switch

Press and hold this switch for approximately 2 seconds or longer to turn off Pre-Collision Braking System and Pre-Collision Throttle Management.

When these functions are off, the Pre-Collision Braking System OFF indicator light on the instrument panel illuminates.

Press and hold the switch again to turn on Pre-Collision Braking System and Pre-Collision Throttle Management. This turns off the Pre-Collision Braking System OFF indicator light.

⇒ Pages 41 and 83

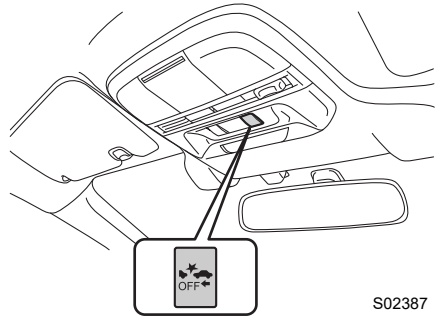

S02387

■ (Lane Departure Warning OFF) switch

Press and hold this switch for approximately 2 seconds or longer to turn off the Lane Departure Warning and Lane Sway Warning functions.

When these functions are off, the Lane Departure Warning OFF indicator light on the instrument panel illuminates.

Press and hold the switch again to turn on the Lane Departure Warning and Lane Sway Warning functions. This turns off the Lane Departure Warning OFF indicator light.

⇒ Pages 86 and 90

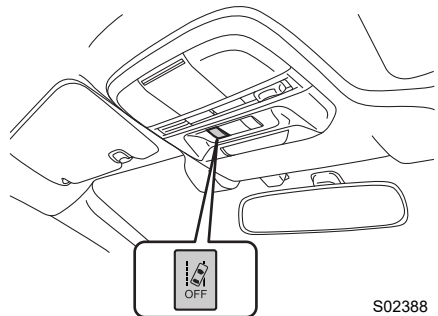

S02388

■ X-MODE switch

Press this switch to turn the X-MODE on/off.
When the X-MODE is activated, the X-MODE indicator illuminates.
When the X-MODE is deactivated, the X-MODE indicator will turn off.
⇒ Refer to the vehicle Owner's Manual for details.

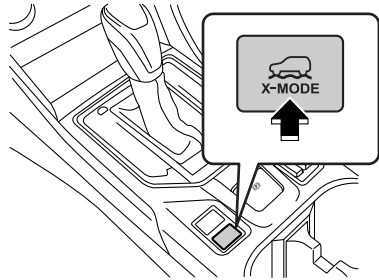

S03265

■ Multi-function display

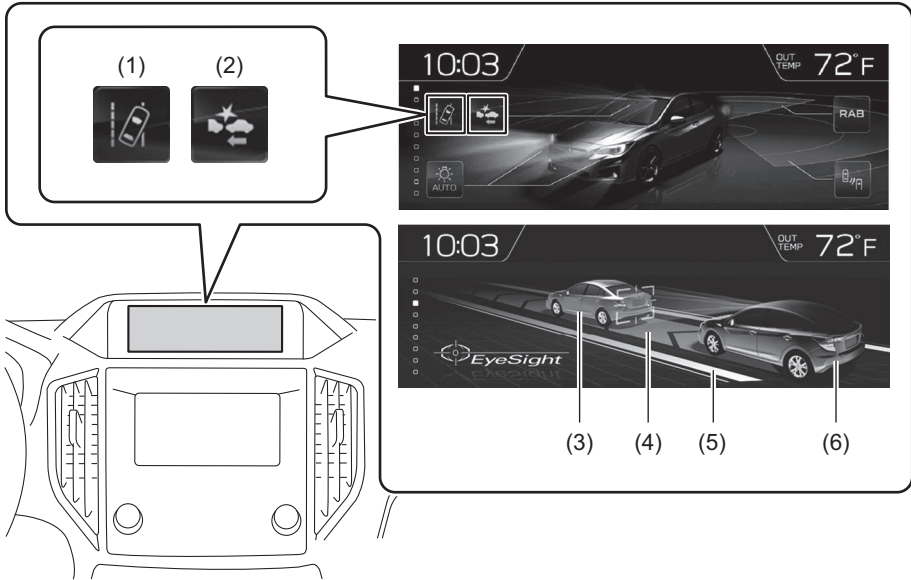

S03952

- | | |
|--|--------------------------------|
| (1) Lane Departure Warning indicator | (4) Lane indicator |
| (2) Pre-Collision Braking System indicator | (5) Road line indicator |
| (3) Lead vehicle indicator | (6) Your own vehicle indicator |

● Lane Departure Warning indicator

This indicator illuminates when Lane Departure Warning and Lane Sway Warning are on.

● Pre-Collision Braking System indicator

This indicator illuminates when Pre-Collision Braking System and Pre-Collision Throttle Management are on.

● **Lead vehicle indicator**

When Adaptive Cruise Control is activated or when the stay-stopped function is engaged, this indicator is displayed when a vehicle in front has been detected. The lead vehicle indicator displays an image of the distance between your vehicle and the vehicle in front of you.

● **Lane indicator**

This indicator is displayed when Lane Keep Assist is active.

● **Road line indicator**

This indicator illuminates when Lane Keep Assist is operational or operating.

● **Your own vehicle indicator**

When the brake pedal is depressed or the brake control function is activated, the brake lights on the vehicle indicator illuminate in red.

Pre-Collision Braking System

When there is the risk of a rear-end collision with an obstacle in front, the EyeSight system helps to prevent or minimize a collision by warning the driver. If the driver still does not take evasive action to avoid a collision, the brakes can be automatically applied just before the collision in order to reduce impact damage, or if possible, prevent the collision. If the driver takes evasive action to avoid a collision, Pre-Collision Braking Assist will operate in order to help the driver to prevent or minimize the collision.

This system can be effective not only with direct rear-end collisions, but also with offset rear-end collisions. This function can be activated when the select lever is in the “D”, “N” or “B” position.



WARNING

- Never use Pre-Collision Braking System and Pre-Collision Braking Assist to stop your car or avoid a collision under ordinary conditions. These functions cannot prevent collisions under all conditions. If the driver relies only on Pre-Collision Braking System for Brake operation, collisions may occur.
- When a warning is activated, pay attention to the front of the vehicle and its surroundings, and operate the brake pedal and/or take other actions if necessary.
- The EyeSight Pre-Collision Braking System is primarily designed to prevent rear-end collisions with other vehicles when possible or to minimize damage and injuries in the event of a collision. In addition to other vehicles, things such as motorbikes, bicycles and pedestrians can also be treated as obstacles. However, there may be cases when detection is not possible depending on a variety of conditions^{*2}. For example, when a vehicle is viewed from the side, oncoming vehicle, vehicles approaching in reverse, small animals or children, or walls or doors are not likely to be detected.
- Pre-Collision Braking System will operate at the point when it determines that a collision cannot be avoided and is designed to apply strong braking force just before a collision. The result of this varies depending on a variety of conditions^{*2}. Because of this, performance of this function will not always be the same.
- When Pre-Collision Braking System is activated, it will continue to operate even if the accelerator pedal is partially depressed. However, it will be canceled if the accelerator pedal is suddenly or fully depressed.
- If the driver depresses the brake pedal or turns the steering wheel, the system may determine that this constitutes evasive action by the driver, and the automatic braking control may not activate in order to allow the driver full control.

- When the difference in speed with the obstacle in front is the following figure^{*1} or more, it may not be possible to avoid a collision. Even if the speed difference is the following figure^{*1} or less, in cases such as when another vehicle cuts in front of you, or in other cases depending on visibility, the condition of road surface and other factors^{*2}, the function may be unable to stop the vehicle or may not activate. Pre-Collision Braking Assist also may not activate depending on the conditions^{*2} listed below.

*1: For vehicles: approximately 30 mph (50 km/h),

For pedestrians: approximately 21 mph (35 km/h)

*2: Conditions in which Pre-Collision Braking System cannot detect obstacles:

- Distance to obstacle in front of you, speed difference, proximity conditions, lateral displacement (the amount of offset)
- Vehicle conditions (amount of load, number of occupants, etc.)
- Road conditions (grade, slipperiness, shape, bumps, etc.)
- Visibility ahead is poor (rain, snow, fog or smoke, etc.).
- The detected object is something other than a vehicle, motorcycle, bicycle or pedestrian.
 - A domestic animal or other animal (a dog or deer, etc.)
 - A guardrail, telephone pole, tree, fence or wall, etc.
- Even if the obstacle is a motorcycle, bicycle or pedestrian, depending on the brightness of the surroundings as well as the relative movement, and aspect or angle of the object, there may be cases when the system cannot detect it.
- The system determines that operation by the driver (based on accelerator pedal operation, braking, steering wheel angle, etc.) is intended as evasive action.
- Vehicle maintenance status (brake systems, tire wear, tire pressure, whether a temporary spare tire is being used, etc.)
- A trailer or another vehicle, etc. is being towed.
- The brakes are cold due to the outside temperature being low or just after starting the hybrid system.
- The brakes are overheated on downhill grades (braking performance is reduced).
- In rain or after washing the vehicle (the brakes are wet and braking performance is reduced.)

Continued on next page ⇒

⇒ Continued from previous page

- Recognition conditions of the stereo camera

In particular, the function may be unable to stop the vehicle or may not activate in the following cases.

- Bad weather (for example heavy rain, a blizzard or thick fog)
- Visibility is poor due to sand, smoke or water vapor blowing in the wind, or the front vision is obscured due to water splashes, snow, dirt or dust stir up generated by the vehicle in front or oncoming traffic.
- At night or in a tunnel without the headlights on
- At night or in a tunnel when there is a vehicle in front that does not have its taillights on
- Approaching a motorcycle, bicycle or pedestrian at night
- Ambient light is poor in the evening or early morning.
- A vehicle, motorcycle, bicycle or pedestrian is outside the area illuminated by the headlights.
- Strong light is coming from the front (for example, sunlight at dawn, sunset or headlight beams, etc.).
- The windshield has become fogged, scratched or smeared, or snow, dirt, dust or frost has adhered to it, or it is otherwise affected. These will reduce the stereo camera's field of view. Also, light is reflecting off the dirt, etc.
- Fluid has not been fully wiped off the windshield during or after washer use.
- The target cannot be correctly recognized because the stereo camera's view is obstructed by water droplets from rain or the window washer, or by the wiper blades.
- The stereo camera's field of view is obstructed (for example by a canoe on the roof of the vehicle).
- The rear aspect of the vehicle in front is low, small or irregular (the system may recognize another part of the vehicle as its rear and will determine operation from that).
- There is an empty truck or trailer with no rear and/or side panels on the cargo bed.

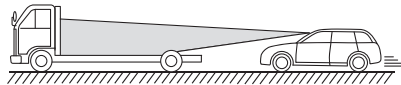

S02133

- Vehicles that have cargo protruding from their back ends
- Non-standard shaped vehicles (vehicle transporters or vehicles with a sidecar fitted, etc.)
- The height of the vehicle is low, etc.
- There is a wall, etc. in front of a stopped vehicle.
- There is another object near the vehicle.
- A vehicle, etc. has its side facing you.
- With vehicles that are backing up or with oncoming vehicles, etc.
- The size and height of an obstacle is smaller than the limitations of the stereo camera's recognition capability.
 - With small animals or children, etc.
 - With pedestrians who are sitting or lying down
- The detected object is a fence or wall, etc. with a uniform pattern (a striped pattern or brick pattern, etc.).
- There is a wall or door made of glass or a mirror in front.
- The vehicle in front suddenly swerves, accelerates, or decelerates.
- A vehicle, motorcycle, bicycle or pedestrian suddenly cuts in from the side or suddenly runs in front of you.
- Your vehicle is immediately behind an obstacle after changing lanes.
- There is a vehicle, motorcycle, bicycle or pedestrian in a location close to your vehicle's bumper.
- The speed difference between your vehicle and an obstacle is 4 mph (5 km/h) or less (As braking is performed once the obstacle is in close proximity to your vehicle, depending on the shape and size of the obstacle, there may be some cases when the obstacle is outside the range of the camera's field of view.).
 - On sharp curves, steep uphill grades or steep downhill grades
 - On a bumpy or unpaved road
 - There are changes in brightness, such as at a tunnel entrance or exit.
- Do not test Pre-Collision Braking System on its own. It may operate improperly and cause an accident.

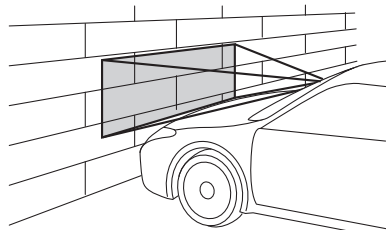

S00653

Continued on next page ⇒

⇒ Continued from previous page

- The system may not operate correctly under the conditions listed below. When these conditions occur, turn off Pre-Collision Braking System.
 - ⇒ Page 41
 - The tire pressure is not correct.*1
 - The temporary spare tire is installed.*1
 - Tires that are unevenly worn or tires with uneven wear patterns are installed.*1
 - Tires that are the wrong size are installed.*1
 - A flat tire has been fixed temporarily with a tire repair kit.
 - The suspension has been modified (including a genuine SUBARU suspension that has been modified).
 - An object that obstructs the stereo camera's view is installed on the vehicle.
 - Tire chains are installed.
 - The headlights are dirty or they have snow and ice or dirt on them. (Objects are not correctly illuminated and are difficult to detect.)
 - The optical axes are not aligned correctly. (Objects are not correctly illuminated and are difficult to detect.)
 - The lights including headlights and fog lights have been modified.
 - Vehicle operation has become unstable due to an accident or malfunction.
 - The brake system warning light is illuminated in red.*2
 - A heavy cargo is loaded onto or inside the vehicle.
 - The maximum number of occupants is exceeded.
 - The combination meter is not operating properly; such as when the lights do not illuminate, the beeps do not sound, the display is different from when it is normal, etc.*3
- *1: The wheels and tires have functions that are critically important. Be sure to use the correct ones. For details, refer to the vehicle Owner's Manual.
- *2: If the brake system warning light does not turn off, immediately pull the vehicle over in a safe place and contact a SUBARU dealer to have the system inspected. For details, refer to the vehicle Owner's Manual.
- *3: For details about the combination meter, refer to the vehicle Owner's Manual.

CAUTION

- In the following situations, turn off Pre-Collision Braking System. Otherwise Pre-Collision Braking System may activate unexpectedly.

⇒ Page 41

- The vehicle is being towed.
- The vehicle is being loaded onto a carrier.
- A chassis dynamometer, free-rollers or similar equipment is being used.
- A mechanic lifts up the vehicle, starts the hybrid system and spins the wheels freely.
- Passing hanging banners, flags or branches
- Thick/tall vegetation is touching the vehicle.
- Driving on a race track
- In a drive-through car wash

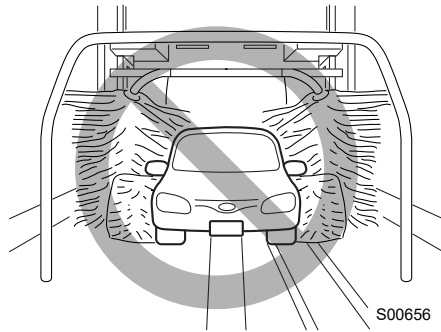

- Pre-Collision Braking System may activate in the following situations. Therefore concentrate on safe driving.

- Passing through an automatic gate (opening and shutting)
- Driving close to the vehicle in front
- Driving in a location where the grade of the road changes rapidly

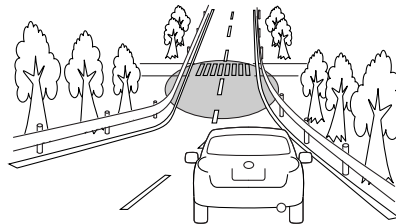
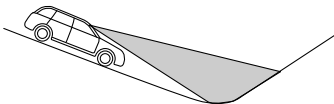

S01264

Continued on next page ⇒

⇒ Continued from previous page

- Visibility is poor due to sand, smoke or water vapor blowing in the wind, or the front vision is obscured due to water splashes, snow, dirt or dust stir up generated by the vehicle in front or oncoming traffic.
- Passing through clouds of steam or smoke, etc.
- In adverse weather, such as heavy snow or snowstorms
- The exhaust gas emitted by the vehicle in front is clearly visible in cold weather, etc.

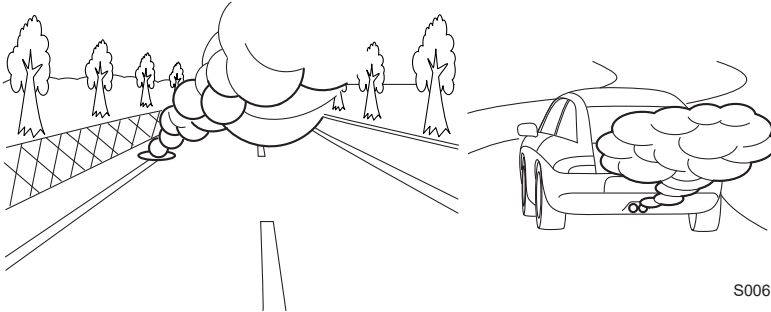

- There is an obstacle on a curve or intersection.
- A vehicle or an object is being narrowly passed.
- Stopping very close to a wall or a vehicle in front

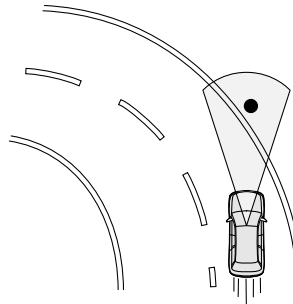

- Passing through water spray from road sprinklers or snow clearing sprinklers on the road

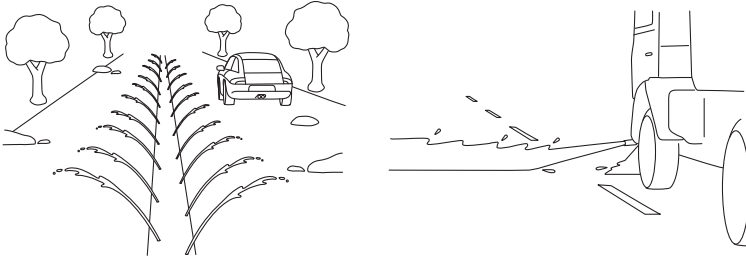

S02636

- If there is cargo or installed accessories, etc. that are protruding beyond the edge of the front bumper, the vehicle's length will increase and the system may not be able to prevent a collision.
- If the driver operates the brake pedal during automatic braking, the pedal may feel stiff; however, this is normal. By depressing the brake pedal further you can apply more braking force.

**NOTE**

Some unusual noises may be audible during automatic braking. This is caused by the braking control and is normal.

■ Detection of pedestrians

The EyeSight system can also detect pedestrians. The EyeSight system detects pedestrians from their size, shape and movement. The system detects a pedestrian when the contour of the head and shoulders are clear.

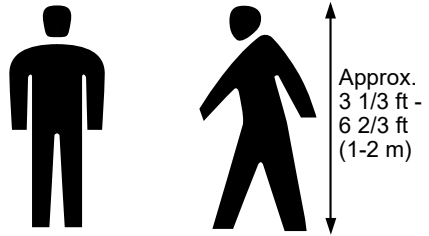

S02846



WARNING

The EyeSight system's Pre-Collision Braking function also identifies pedestrians as obstacles. However, depending on the conditions, there may be cases when the system cannot detect a pedestrian. In the following conditions, the possibility that the system may not be able to detect a pedestrian as an object is particularly high.

- Pedestrians are walking in a group.
- A pedestrian is next to a wall or other obstacle.
- A pedestrian is using an umbrella.
- A pedestrian is wearing clothes that are a similar color to the surrounding environment.
- A pedestrian is carrying bulky luggage.
- A pedestrian is bent over, crouching down or lying down.
- A pedestrian is in a dark location.
- A pedestrian suddenly crosses in front of you from the side or suddenly runs in front of you.

Pre-Collision Braking System operation

When there is an obstacle in front of you during driving, the system activates in the following sequence in order to warn the driver and to activate braking control and the brake lights.

Following Distance Warning:

When the system determines that there is a risk of collision, an alert sounds repeated short beeps and an interruption screen is displayed on the combination meter display to warn the driver.

When the driver depresses the brake pedal to decelerate and achieves a suitable following distance, the warning is canceled.

The Following Distance Warning operates when Adaptive Cruise Control is not activated.

First Braking and Warning:

When the system determines that there is a high risk of collision with an obstacle in front, an alert sounds repeated short beeps an interruption screen is displayed on the combination meter display to warn the driver. Braking control may be activated and in some situations, hybrid system output may also be controlled. If the system determines that the amount of evasive action (braking, steering, etc.) taken by the driver has reduced the risk of collision, braking activation is canceled.

Secondary Braking and Warning:

If the system then determines that the risk of collision is extremely high, the alert changes to a continuous beeping sound and stronger braking control is activated. Despite any evasive action taken by the driver, if the system subsequently determines that a collision is unavoidable, the system continues to control braking and hybrid system output.

Apply Brake message

Even after the vehicle has stopped, depress the brake pedal. Until the brake pedal is depressed, a message appears and stays in the warning screen area of the combination meter display for approximately 2 minutes. A single continuous beep sounds while the message is displayed.



S02552

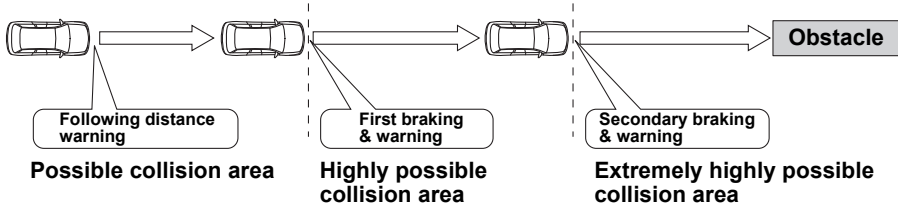



S03875

Operating system	Strength of Automatic Braking	Indication on the combination meter display	Alert type
Following distance warning	No brake control		Repeated short beeps
First braking	Moderate		Repeated short beeps
Secondary braking	Strong		Single continuous beep

S03176

**NOTE**

- In the following cases, the brake control after the vehicle has come to a stop through Pre-Collision Braking System will be released.
 - Depress the brake pedal.
 - Depress the accelerator pedal (except when the select lever is in the “N” position).
 - Shift the select lever into the “P” position.
- After stopping with secondary braking, in the following cases, brake control will be released and the electronic parking brake will be applied. (For details about how to release the electronic parking brake, refer to the vehicle Owner’s Manual.)
 - Approximately 2 minutes have elapsed since stopping and the brake pedal is not depressed.
 - Any door (except the rear gate) is opened.
 - The EyeSight system has a malfunction.  (EyeSight warning indicator: Yellow)
 - ⇒ Page 108
 - The EyeSight system has stopped temporarily.  (EyeSight temporary stop indicator: White)
 - ⇒ Page 109
- Neither first braking nor secondary braking will operate in the following cases.
 - The vehicle speed is approximately 1 mph (1 km/h) or less (When the select lever is in the “N” position and your vehicle speed is approximately 2 mph (4 km/h) or less) or 100 mph (160 km/h) or more.
 - Vehicle Dynamics Control is active.
- If the system detects the brake lights of the vehicle in front, your vehicle will start decelerating earlier than if it does not.
- There are some cases where the first braking is applied for a longer period of time. One of the reasons for this is due to a large speed difference with an obstacle in front. In those cases, stronger or weaker braking control may be activated.

Pre-Collision Braking Assist operation

When Pre-Collision Braking System is activated (when the system determines that there is a high risk of collision with an obstacle in front), if the driver depresses the brake pedal, the system determines that this is emergency braking and activates braking assist automatically.



CAUTION

If the driver depresses the brake pedal while following distance warning is activated, Pre-Collision Braking Assist will not work. The vehicle decelerates with the normal braking force operated by the driver.



NOTE

- Pre-Collision Braking Assist function does not operate when the vehicle speed is approximately 7 mph (10 km/h) or less or 100 mph (160 km/h) or more.
- For information about the brake assist function, refer to the vehicle Owner's Manual.

Turning off Pre-Collision Braking System

Press and hold the Pre-Collision Braking System OFF switch for approximately 2 seconds or longer to turn off Pre-Collision Braking System (including Pre-Collision Braking Assist). When 1 short beep sound emits, this control is turned off and the Pre-Collision Braking System OFF indicator light on the instrument panel illuminates.

To turn the control back on, press and hold the Pre-Collision Braking System OFF switch for approximately 2 seconds or longer again. When this control is turned on, the Pre-Collision Braking System OFF indicator light turns off.

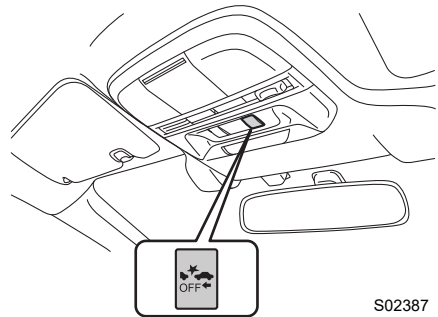

NOTE

- When Pre-Collision Braking System is turned off, the Pre-Collision Throttle Management Control function is also turned off.
- Even when Pre-Collision Braking System is turned off, if the hybrid system is turned off and then restarted, Pre-Collision Braking System will be turned on. The system default setting when the vehicle is restarted is on.

■ Pre-Collision Braking System OFF indicator light

This indicator light illuminates when the ignition switch is turned to the ON position, and then turns off approximately 7 seconds after the hybrid system starts. It illuminates when Pre-Collision Braking System and Pre-Collision Throttle Management are turned off. It also illuminates under the following conditions.

- The EyeSight system has a malfunction.

 (EyeSight warning indicator: Yellow)

⇒ Page 108

- The EyeSight system has stopped temporarily.  (EyeSight temporary stop indicator: White)

⇒ Page 109

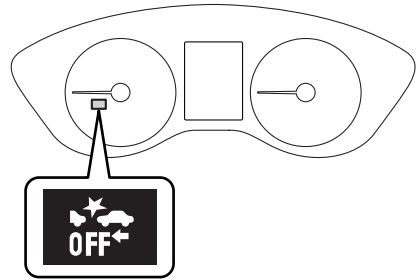

H00005



NOTE

When the Pre-Collision Braking System OFF indicator light illuminates, Pre-Collision Braking System (including the Pre-Collision Braking Assist function) and Pre-Collision Throttle Management do not operate.

Adaptive Cruise Control

Adaptive Cruise Control is a driving support system intended to allow more comfortable driving on expressways, freeways and interstate highways. The stereo camera detects vehicles in front that are driving in the same traffic lane, and your vehicle follows the vehicle in front (up to the maximum speed of the set vehicle speed). While following, your vehicle will automatically maintain a following distance that corresponds to the speed of the vehicle in front. When the vehicle in front comes to a complete stop, your vehicle will also be stopped and the electronic parking brake will be automatically applied. The vehicle is capable of being controlled at a speed between 0 mph (0 km/h) and approximately 90 mph (145 km/h). Please remember that you should not exceed posted speed limits.



WARNING

- This system does not provide the driver with an automatic driving function that handles all traffic conditions.
- Do not rely excessively on Adaptive Cruise Control. This system is not intended to assist in driving when the driver is not paying full attention to what is ahead of him/her due to distractions or a lack of concentration while driving, or under conditions of poor visibility. It is not intended to prevent rear-end collisions.

Strive for safe driving at all times. Always maintain a safe following distance behind the vehicle in front of you, pay attention to your surroundings and the driving conditions, and operate the brake pedal and take other actions as necessary.

- When using Adaptive Cruise Control, always set the speed according to the speed limit, traffic flow, road conditions, and other conditions.
- Before using the system, perform a daily inspection and verify that there are no malfunctions of the tires or brakes.
 - ⇒ Refer to “Warranty and Maintenance Booklet”.
- The system may not operate correctly under the conditions listed below. When these conditions occur, do not use Adaptive Cruise Control.
 - The tire pressure is not correct.*¹
 - The temporary spare tire is installed.*¹
 - Tires that are unevenly worn or tires with uneven wear patterns are installed.*¹
 - Tires that are the wrong size are installed.*¹
 - A flat tire has been fixed temporarily with a tire repair kit.
 - The suspension has been modified (including a genuine SUBARU suspension that has been modified).
 - An object that obstructs the stereo camera’s view is installed on the vehicle.
 - Tire chains are installed.
 - The headlights are dirty or they have snow and ice or dirt on them. (Objects are not correctly illuminated and are difficult to detect.)

Continued on next page ⇒

⇒ Continued from previous page

- The optical axes are not aligned correctly. (Objects are not correctly illuminated and are difficult to detect.)
- The lights including headlights and fog lights have been modified.
- Vehicle operation has become unstable due to an accident or malfunction.
- The brake system warning light is illuminated in red.*²
- A heavy cargo is loaded onto or inside the vehicle.
- The maximum number of occupants is exceeded.
- A trailer or another vehicle, etc. is being towed.
- The combination meter is not operating properly; such as when the lights do not illuminate, the beeps do not sound, the display is different from when it is normal, etc.*³

*1: The wheels and tires have functions that are critically important. Be sure to use the correct ones. For details, refer to the vehicle Owner's Manual.

*2: If the brake system warning light does not turn off, immediately pull the vehicle over in a safe place and contact a SUBARU dealer to have the system inspected. For details, refer to the vehicle Owner's Manual.

*3: For details about the combination meter, refer to the vehicle Owner's Manual.

- Adaptive Cruise Control is designed for use on expressways, freeways, toll roads, interstate highways and similar limited access roads. It is not intended to be used in city traffic. In the following conditions, do not use Adaptive Cruise Control. Doing so may result in an accident.
 - Ordinary roads (roads other than those mentioned above)
Depending on the driving environment (complexity of roads and other factors), the system may not be able to perform as the traffic conditions require, and that may result in an accident.
 - Sharp curves or winding roads
 - Frozen roads, snow-covered roads or other slippery road surfaces
The tires may spin, causing loss of control of the vehicle.
 - Traffic conditions when frequent acceleration and deceleration make it difficult to maintain the following distance
It may not be possible for the system to perform as the traffic conditions require.
 - Steep downhill grades
The set vehicle speed may be exceeded.
 - On a steep continuous downhill grade
The brakes may overheat.

- Roads and overpasses with repeated steep uphill and downhill grades
Detection of the vehicle in front may be lost, or the road surface may be detected instead of the vehicle in front, making correct control impossible.
- Entering a sharp curve/turn into an interchange or junction, or a service area, parking area, toll booth or other facilities
Detection of the vehicle in front may not be possible.
- There are changes in brightness, such as at a tunnel entrance or exit.
- Visibility is poor due to sand, smoke or water vapor blowing in the wind, or the front vision is obscured due to water splashes, snow, dirt, water spray from road sprinklers or snow clearing sprinklers on the road, or dust stir up generated by the vehicle in front or oncoming traffic.
Detection of the vehicle in front may be lost, or water or other substances may be incorrectly detected instead, making correct control impossible.

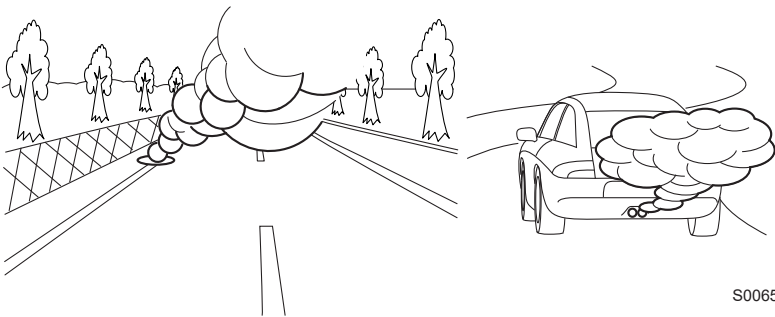

S00652

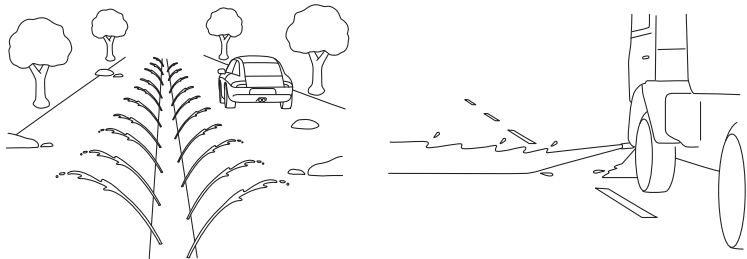

S02636

- In adverse weather, such as heavy snow or snowstorms
- The windshield has become fogged, scratched or smeared, or snow, dirt, dust or frost has adhered to it, or it is otherwise affected. These will reduce the stereo camera's field of view. Also, light is reflecting off the dirt, etc.

Continued on next page =>

⇒ Continued from previous page

- Water droplets from rain or the window washer, or dirt has not been fully wiped off the windshield.
It may not be possible to detect the vehicle in front, making correct control impossible.
- The stereo camera's field of view is obstructed (for example by a canoe on the roof of the vehicle).
- The stereo camera may have difficulty detecting the following objects or conditions. Operate the brake pedal and take other actions as necessary.
 - Vehicles at significantly different speeds (vehicles driving slowly, stopped or oncoming vehicles, etc.)
 - Vehicles cutting into your lane
 - Motorcycles, bicycles, pedestrians and animals, etc.
 - Light is poor in the evening or early morning.
 - At night or in a tunnel without the headlights on
 - At night or in a tunnel when there is a vehicle in front that does not have its taillights on
 - Strong light is coming from the front (sunlight or headlight high beams, etc.).
 - The rear aspect of the vehicle in front is low, small or irregular (the system may recognize another part of the vehicle as its rear and will determine operation from that).
 - There is an empty truck or trailer with no rear and/or side panels on the cargo bed.
 - Vehicles that have cargo protruding from their back ends
 - Non-standard shaped vehicles (vehicle transporters or vehicles with a sidecar fitted, etc.)
 - The height of the vehicle is low, etc.
 - Objects that are located close to the bumper of your vehicle
- When you do not want to use Adaptive Cruise Control, be sure to turn the  (CRUISE) switch off. If the switch is left on, cruise control may be accidentally engaged, possibly resulting in an accident.
- Before using Adaptive Cruise Control, be sure to fully verify the safety of the vehicle occupants and the area around the vehicle. Never operate the cruise control from outside the vehicle.

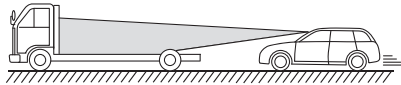

S02133

Detection of the vehicle in front by the EyeSight stereo camera*

- Under the following road conditions or conditions of your vehicle, detection of the vehicle in front may not be possible. Vehicles in neighboring traffic lanes or roadside objects may also be incorrectly detected. Under conditions such as these, do not use Adaptive Cruise Control. If cruise control is currently in use, operate the brake pedal and take other actions as necessary.

- Following begins from a short following distance, such as when the vehicle in front is a vehicle that cut into your lane.

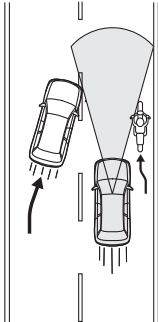

S01975

- On curved roads, at the start and end of a curve and on roads with continuous curves (These conditions make it difficult for the system to detect vehicles because they are outside the detectable area.)

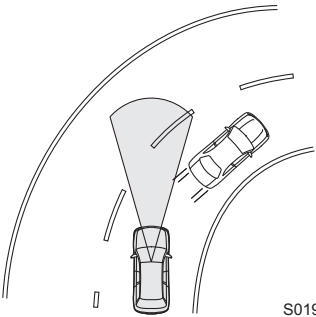

S01976

- On an on-ramp or off-ramp to a freeway, highway, or other restricted access road (EyeSight Adaptive Cruise Control is not designed for use in this kind of driving environment.)
- In an urban or suburban environment (Adaptive Cruise Control is not appropriate for use in these driving areas. Use Adaptive Cruise Control only on limited-access highways.)

Continued on next page ⇒

⇒ Continued from previous page

- The vehicle in front is not directly ahead of your vehicle and is shifted to one side.

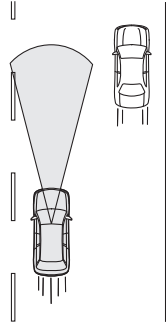

S01977

- There is an obstacle on the side of the road.
- The relative speed difference compared to the vehicle in front is large.
- A vehicle cuts into your lane in front of you.
- The distance between vehicles is extremely short.
- Your vehicle is drifting within the lane.
- On a bumpy or unpaved road surface

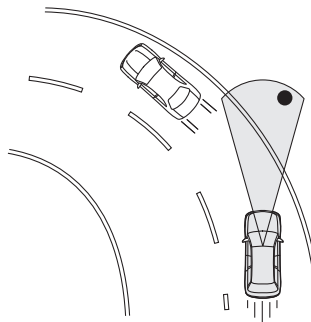

S01978

- On a road with extremely narrow lanes, such as when traffic restrictions are in effect or in areas where construction work is taking place
- Normal driving has become unstable due to an accident or malfunction.
- Extremely heavy cargo is loaded in the cargo area or rear seat of your vehicle.
- There are limits to the situation judgment capabilities of the Adaptive Cruise Control system. Deceleration may not take place in time in the following situations. Depress the brake pedal to decelerate the vehicle if necessary.
 - The speed difference with the vehicle in front is too large or the vehicle in front decelerates unexpectedly.
 - The decelerating vehicle in front unexpectedly slows down or suddenly brakes.
- If the alert/notification sounds frequently, do not use Adaptive Cruise Control.

- Even when the following distance is short, the “Obstacle Detected” warning may not activate in the following situations.
 - The difference in speed with the vehicle in front is small. The two vehicles are traveling at almost the same speed.
 - The vehicle in front is traveling faster than your vehicle. The following distance is gradually increasing.
 - Another vehicle cuts into your lane very close to your vehicle.
 - The vehicle in front decelerates suddenly.
 - There are repeated uphill and downhill grades.

⇒ Page 67

*: The recognition status of the lead vehicle using the stereo camera can be confirmed by the illumination status of the lead vehicle indicator.

⇒ Page 53



 **CAUTION**

- After Adaptive Cruise Control has started, it maintains control continuously according to the movement of the vehicle in front. When your vehicle comes to a stop if the vehicle in front has stopped, the stay-stopped function is engaged. However, if the EyeSight stereo camera has lost detection of the vehicle in front, the system may not stop your vehicle. Operate the brake pedal and maintain the correct following distance as necessary. Be aware that the EyeSight system has difficulty detecting objects or vehicles that have a relative speed in comparison to your vehicle. Therefore, if the EyeSight system loses detection just as you are approaching a line of stopped cars, for example, you will have to brake manually.
- There is no possibility that the vehicle will automatically begin moving from a stay-stopped condition without operation from the driver.
- If the conditions for automatically canceling cruise control (⇒ page 64) are met while the vehicle is stay-stopped, Adaptive Cruise Control is canceled. For safety reasons, the electronic parking brake is automatically applied.
- Braking may not be sufficient depending on the following conditions. Depress the brake pedal and decelerate as necessary.
 - Vehicle conditions (amount of load, number of occupants, etc.)
 - Road conditions (grade, slipperiness, shape, bumps, etc.)
 - Vehicle maintenance condition (brake systems, tire wear, air pressure, temporary spare tire is being used, etc.)
 - The brakes are cold. (For example, just after the hybrid system is started or the outside temperature is low.)
 - For a short period of time when driving after the hybrid system is started until the engine has warmed-up
 - The brakes are overheated on downhill grades (braking performance may be reduced).
 - In rain or after washing the vehicle (the brakes may become wet and braking performance may be reduced.)

How to use Adaptive Cruise Control

■ Setting Adaptive Cruise Control

(1) Setting Adaptive Cruise Control to standby status

Press the  (CRUISE) switch. At this time,  (Adaptive Cruise Control indicator) (white), your vehicle indicator and the following distance setting indicator are displayed on the EyeSight display area of the combination meter display.

The set vehicle speed display will read "-- MPH (- - - km/h)".

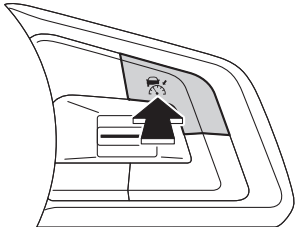

S03393

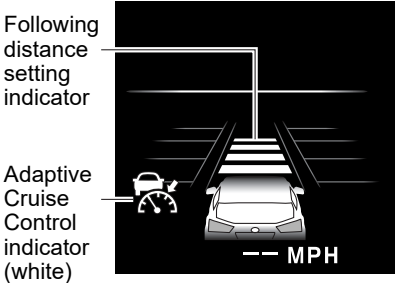

S03067

To set the ready status:

Adaptive Cruise Control can be activated when all of the following conditions are met and **READY** (READY indicator) is displayed on the EyeSight display area.

- All doors (except the rear gate) are closed.
- The driver's seatbelt is fastened.
- The electronic parking brake is not engaged. The electronic parking brake indicator light is turned off.
- The select lever is in the "D" position.
- The brake pedal is not depressed while driving or the brake pedal is strongly depressed while stopping.

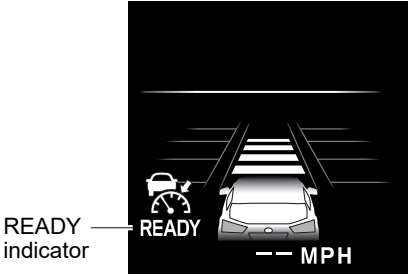

S02709

- EyeSight operation is not temporarily stopped.  (EyeSight temporary stop indicator: White) is turned off.
⇒ Page 109
- The road is not a steep slope.
- The steering wheel has not been turned significantly in either direction.
- The X-MODE is not turned on (the X-MODE indicator goes off).
- The vehicle speed is between 0 mph (0 km/h) and approximately 90 mph (145 km/h).

(2) Setting Adaptive Cruise Control

Press the RES/SET switch to the “SET/-” side or the “RES/+” side.

Adaptive Cruise Control is activated and control starts, using the vehicle speed at the time when the switch was pressed as the set vehicle speed.

If no vehicle in front has been detected, the vehicle drives at the constant set vehicle speed.

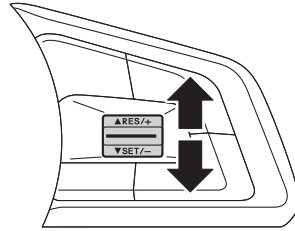

S03394

When Adaptive Cruise Control is activated, **READY** (READY indicator) turns off, the set vehicle speed is displayed, and  (Adaptive Cruise Control indicator) changes from white to green.

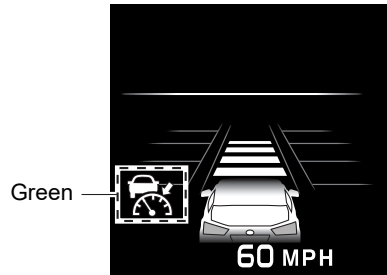





S03172



WARNING

When using Adaptive Cruise Control, always set the speed according to the speed limit, traffic flow, road conditions, and other conditions.

**NOTE**

- The set vehicle speed can be set between 20 mph (30 km/h) and 90 mph (145 km/h).
- If the vehicle speed is approximately 20 mph (30 km/h) or less when the vehicle speed is set, the set vehicle speed is set to 20 mph (30 km/h).
- When driving on a curve, the vehicle may not accelerate, or may decelerate, even if the set vehicle speed is higher than the current vehicle speed.
- If  (Adaptive Cruise Control indicator) does not illuminate even when the  (CRUISE) switch is pressed, Adaptive Cruise Control will not operate.
- If  (Adaptive Cruise Control indicator) does not illuminate even when the  (CRUISE) switch is pressed and this occurs frequently, there may be a malfunction in the system. Contact a SUBARU dealer and have the system inspected.

When a vehicle in front is detected, a notification sounds 1 short beep and the lead vehicle indicator will illuminate.

The vehicle follows the lead vehicle in front and maintains the selected following distance. At this time, the cruise speed is adjusted to and will not exceed the set vehicle speed. If the vehicle in front is no longer detected, a notification sounds 1 short beep and the lead vehicle indicator turns off.

Lead vehicle indicator

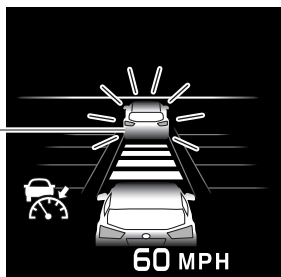

S02710

**NOTE**

The notification sound (lead vehicle acquisition sound) that occurs when a vehicle in front is detected or no longer detected while Adaptive Cruise Control is activated can be turned off by customization.

⇒ Page 111

Operation of Adaptive Cruise Control

- When no vehicle in front is detected
The vehicle drives constantly and correspondingly to the set vehicle speed between 20 mph (30 km/h) and 90 mph (145 km/h).

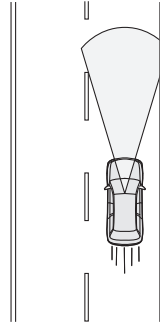

S01979

- When a vehicle in front is detected
The vehicle follows the lead vehicle in front, and will maintain the chosen following distance (there are four settings), up to the set vehicle speed between 20 mph (30 km/h) and 90 mph (145 km/h).

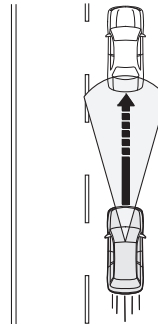

S01980

- If your vehicle no longer detects the vehicle in front
The vehicle gradually accelerates back to the set vehicle speed and will drive at that constant speed.
If a vehicle in front is detected while accelerating to the set vehicle speed, vehicle following will be started again.

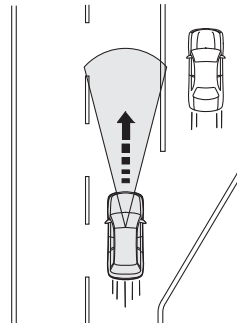

S01981

**CAUTION**

If the driver operates the brake pedal during automatic braking, the pedal may feel stiff; however, this is not a malfunction. By depressing the brake pedal further you can apply more braking force. When the brake pedal is released it will return to its original condition.

**NOTE**

- When the brakes are applied by Adaptive Cruise Control, the vehicle's brake lights will illuminate.
- Even if there is no lead vehicle present, on a downhill grade, the Adaptive Cruise Control's automatic brake may operate in order to maintain the set vehicle speed.
- Some noises may be audible during automatic braking. This is caused by the braking control and does not indicate a malfunction.
- To temporarily accelerate quickly, use the accelerator pedal. After accelerating, the vehicle will gradually return to the set vehicle speed shown in the set vehicle speed display.
- If the vehicle in front is no longer detected while your vehicle is still controlled by the automatic braking operation, the brake will be automatically released gradually. Depress the accelerator pedal if necessary.
- The lead-vehicle following function has the following characteristics:
 - If the lead vehicle's brake lights are detected, deceleration will start earlier than without detection.
 - If the vehicle moves to the fast lane while traveling more than approximately 37 mph (60 km/h), the system starts acceleration to the set vehicle speed more quickly because it is linked with the turn signal.

■ Increasing the set vehicle speed

● Using the RES/SET switch

- Push to the “RES/+” side briefly.
Every time the switch is pushed, the set vehicle speed will increase to the next 5 mph (5 km/h) increment.
- Push to the “RES/+” side continuously.
While the switch is being pushed, the set vehicle speed will increase in increments of 1 mph (1 km/h).

When operating the switch, the set vehicle speed changes on the combination meter display.

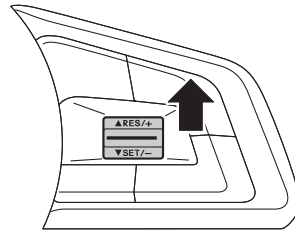

S03395

● Using the accelerator pedal

1. Depress the accelerator pedal to increase vehicle speed.
2. When the desired speed is reached, press the RES/SET switch to the “SET/-” side.
The speed at the time of pressing the switch will be set as the new set vehicle speed, and it appears on the EyeSight display area.

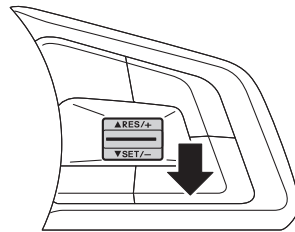

S03396

CAUTION

- When the vehicle is following the lead vehicle, the actual vehicle speed is controlled according to the lead vehicle. Therefore, if the RES/SET switch is pressed to the “RES/+” side and set to a speed higher than the speed of the lead vehicle, the vehicle will not accelerate; it will maintain a safe following distance as the first priority. However, because doing so changed the set vehicle speed, when the lead vehicle is no longer detected (for example, if you change to a freeway lane with no vehicles in front), the vehicle will accelerate to that new set vehicle speed. Change the set vehicle speed while briefly checking the value shown in the set vehicle speed display on the EyeSight display area.
- When the accelerator pedal is depressed with Adaptive Cruise Control on, automatic braking control and warnings by Adaptive Cruise Control will not occur. However, if there is a high risk of collision with an obstacle in front of the vehicle at this time, the warning and braking control of Pre-Collision Braking System may activate.

■ Decreasing the set vehicle speed

● Using the RES/SET switch

- Push to the “SET/-” side briefly.
Every time the switch is pushed, the set vehicle speed will decrease to the next 5 mph (5 km/h) decrement.
- Push to the “SET/-” side continuously.
While the switch is being pushed, the set vehicle speed will decrease in decrements of 1 mph (1 km/h).

When operating the switch, the set vehicle speed changes on the combination meter display.

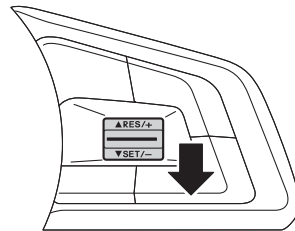

S03396



● Using the brake pedal

1. Depress the brake pedal to decrease the vehicle speed.
Adaptive Cruise Control will be canceled and  (Adaptive Cruise Control indicator) changes from green to white.
2. When the desired speed is reached, press the RES/SET switch to the “SET/-” side.
The speed at the time of pressing the switch will be set as the new set vehicle speed, and it appears on the EyeSight display area.

■ Accelerating temporarily

Depress the accelerator pedal to accelerate temporarily.

When the accelerator pedal is released, the vehicle returns to the set vehicle speed.

When the driver accelerates the vehicle by depressing the accelerator pedal while Adaptive Cruise Control is operating,  (Adaptive Cruise Control indicator) turns white. When the acceleration is completed,  (Adaptive Cruise Control indicator) returns to green.

■ Decelerating temporarily

Depress the brake pedal to decelerate temporarily. When the brake pedal is depressed, Adaptive Cruise Control will be canceled.

 (Adaptive Cruise Control indicator) changes from green to white while the set vehicle speed remains displayed on the EyeSight display area.

Release the brake pedal and press the RES/SET switch to the "RES/+" side to reset the set vehicle speed.

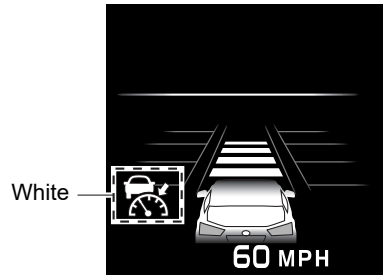

S03173

CAUTION

When following another vehicle while using Adaptive Cruise Control, your vehicle will accelerate or slow down based on the speed of the lead vehicle.

However, the driver always remains responsible for safe driving and should not rely too much on the system.

If you need to accelerate (for example, to make a lane change) or slow down (for example, because the lead vehicle suddenly slows down or another vehicle cuts into your path), then operate either the accelerator or the brake pedal as appropriate based on surrounding conditions.

■ Changing the following distance from the vehicle in front

The following distance from the vehicle in front setting can be changed in 4 stages.

 : When the switch (▲ side) is pressed, the following distance will be longer.

 : When the switch (▼ side) is pressed, the following distance will be shorter.

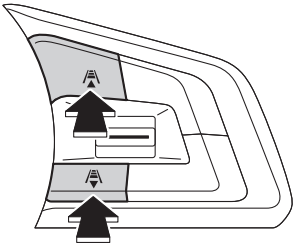





S03397

NOTE

- The following distance changes corresponding with the vehicle speed. The faster the vehicle travels, the greater the following distance.

Approximate guide to following distances

Following distance indicator	When your vehicle speed is 25 mph (40 km/h)	When your vehicle speed is 60 mph (100 km/h)
	Approx. 100 ft (30 m)	Approx. 200 ft (60 m)
	Approx. 80 ft (25 m)	Approx. 160 ft (50 m)
	Approx. 65 ft (20 m)	Approx. 130 ft (40 m)
	Approx. 50 ft (15 m)	Approx. 100 ft (30 m)

- The following distance previously set is restored when you turn back on Adaptive Cruise Control by pressing the  (CRUISE) switch.

■ Stay-stopped function

If the vehicle in front comes to a stop while you are utilizing Adaptive Cruise Control, your vehicle will also come to a stop and will stay stopped.

Once your vehicle has come to a complete stop with the vehicle in front, Adaptive Cruise Control is paused and the stay-stopped function is engaged. When  (Adaptive Cruise Control indicator) changes from green to white, **HOLD** (HOLD indicator) and **READY** (READY indicator) will be displayed.

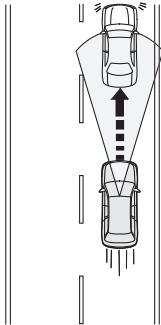

S01982

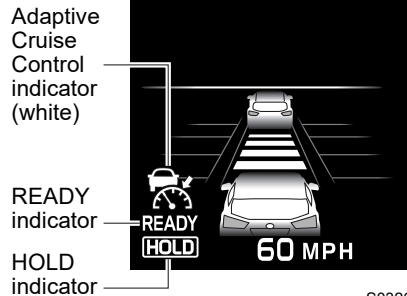

S03266

Regardless of whether or not there is a vehicle in front, if the brake pedal is strongly depressed while the vehicle is stopped, **READY** (READY indicator) illuminates. Operating the RES/+ switch or SET/- switch at this time activates the stay-stopped function.

When starting the stay-stopped function, **HOLD** (HOLD indicator) illuminates and **READY** (READY indicator) turns off. **READY** (READY indicator) will illuminate again by releasing the brake pedal.

CAUTION

Approximately 1 second is required from when the vehicle stops until the stay-stopped function activates. Because there is the possibility that the vehicle may start moving before the stay-stopped function activates, pay attention to the surroundings and depress the brake pedal as necessary.

NOTE

If you depress the brake pedal softly, the stay-stopped function may not start. In this case, **READY** (READY indicator) will not illuminate.

● Resuming Adaptive Cruise Control in stay-stopped status

▼ Setting using the RES/SET switch

Even when the vehicle in front remains stopped, Adaptive Cruise Control can be activated by operating the RES/+ switch or SET/- switch. **HOLD** (HOLD indicator) and **READY** (READY indicator) turn off, and  (Adaptive Cruise Control indicator) changes from white to green.

- Press the SET/- switch. The speed is automatically set to 20 mph (30 km/h).
- Press the RES/+ switch. The vehicle speed that was set before the stay-stopped function activated is set again.

⇒ Page 66



NOTE

When Adaptive Cruise Control is resumed from stay-stopped status and the vehicle in front accelerates, your vehicle will also accelerate and continue to follow the vehicle in front at the previously set following distance. However, if the lead vehicle does not start moving or pauses, stay-stopped status will be automatically restored after approximately 3 seconds.

▼ Setting with the accelerator pedal

Depressing the accelerator pedal while stay-stopped is engaged cancels stay-stopped status. At this time, Adaptive Cruise Control is resumed. The vehicle will attempt to travel at the previously set vehicle speed unless a lead vehicle is detected. If a lead vehicle is detected, Adaptive Cruise Control will maintain the previous following distance setting.



WARNING

When the stay-stopped function is canceled, the vehicle will start. Make sure the surroundings are safe before canceling the stay-stopped function.



NOTE

If the accelerator pedal is only slightly depressed, the stay-stopped function may not be canceled, and Adaptive Cruise Control may not be resumed.

● Canceling the stay-stopped function

If any of the following operations are performed while the vehicle is in the stay-stopped function (⇒ page 60), the stay-stopped function will be canceled and Adaptive Cruise Control will be canceled at the same time.

- The brake pedal is depressed.
- The  (CRUISE) switch is pressed.
- The electronic parking brake switch is operated to manually apply the electronic parking brake.



WARNING

- When the stay-stopped function is canceled by pressing the  (CRUISE) switch, the vehicle will start to creep. Depress the brake pedal as necessary.
- Do not exit the vehicle while the stay-stopped function is engaged.
- The stay-stopped function is not a replacement for engaging the electronic parking brake. When parking, always apply brakes manually to come to a full stop, then set the electronic parking brake.



CAUTION

The stay-stopped function of cruise control will be canceled under the following conditions:

- The vehicle is in stay-stopped mode for approximately 2 minutes or more. A notification will sound 5 intermittent beeps, 1 short beep and 1 long beep.
- Any condition in which automatic cancellation is met. A notification sounds 1 short beep and 1 long beep.

⇒ Page 64

After the stay-stopped function has been canceled, the electronic parking brake will be automatically applied and the electronic parking brake indicator light will illuminate. However, if any canceling condition for the electronic parking brake (i.e. the interlock system with the accelerator pedal, switch operation of the electronic parking brake, etc.) is fulfilled, the electronic parking brake will not work. For details, refer to the vehicle Owner's Manual.

If the accelerator pedal is only slightly depressed while the stay-stopped function is activated, the stay-stopped function of cruise control may be canceled, and the electronic parking brake may not work.

● **Setting Adaptive Cruise Control while the electronic parking brake is applied**

If the electronic parking brake is applied before setting Adaptive Cruise Control, release the electronic parking brake by depressing the accelerator pedal or by other specified means. For details of how to release the electronic parking brake, refer to the vehicle Owner's Manual.

■ **Canceling Adaptive Cruise Control**

● **Canceling by driver operation**

Any of the following operations will cancel Adaptive Cruise Control.

- Depress the brake pedal.

 (Adaptive Cruise Control indicator) changes from green to white while the set vehicle speed remains displayed on the EyeSight display area.

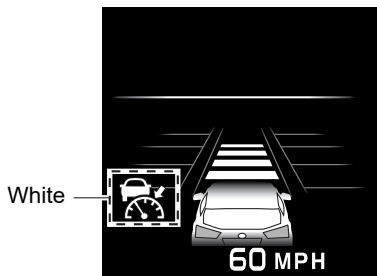

S03173

- Press the  (CRUISE) switch.

 (Adaptive Cruise Control indicator) changes from green to white while the set vehicle speed remains displayed on the EyeSight display area.

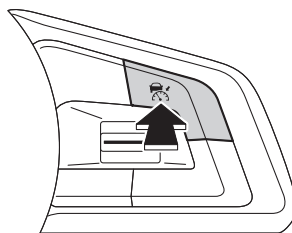



S03393

● Automatic cancellation by the system

In the following cases, a notification will sound 1 short beep and 1 long beep and Adaptive Cruise Control is automatically canceled.

 (Adaptive Cruise Control indicator) changes from green to white. Also, the Adaptive Cruise Control cancellation message is displayed on the screen.

If the stay-stopped function is engaged (⇒ page 60), the electronic parking brake will be automatically engaged.

- The grade of the road is very steep.
- Vehicle Dynamics Control or Traction Control Function is activated.
- The vehicle speed has exceeded approximately 100 mph (160 km/h) while cruise control is activated.
- The steering wheel is turned significantly in either direction.
- The select lever is moved to a position other than “D”.
 - Adaptive Cruise Control can be resumed after the select lever is returned to the “D” position.
- Any door (except the rear gate) is opened.
- The driver’s seatbelt is unfastened.
- The electronic parking brake is engaged manually.
- The X-MODE is turned on (the X-MODE indicator illuminates).
 - Adaptive Cruise Control can be resumed after the X-MODE is turned off.
- The EyeSight system has a malfunction.  (EyeSight warning indicator: Yellow) ⇒ Page 108
- The EyeSight system has stopped temporarily.  (EyeSight temporary stop indicator: White) ⇒ Page 109
- The Pre-Collision secondary braking is activated.

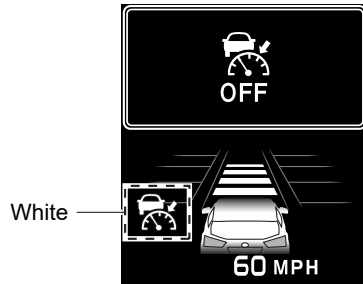

S03175





WARNING

Do not use Adaptive Cruise Control on slippery roads. Doing so may result in an accident.



CAUTION

- When shifting the select lever to the “N” or “B” position, Adaptive Cruise Control will be automatically canceled. Do not shift the lever to the “N” position unless in an emergency. Otherwise the engine brake may not operate, which could cause an accident.
- When a vehicle stops, if an automatic cancellation is performed by the system before starting the stay-stopped function (⇒ page 60), the electronic parking brake will not operate.

NOTE

- If EyeSight is malfunctioning,  (EyeSight warning indicator: Yellow) is displayed on the combination meter display, and the Pre-Collision Braking System OFF indicator light and Lane Departure Warning OFF indicator light will also illuminate. If this occurs, stop the vehicle in a safe location and then turn off the hybrid system and restart it. If the indicators remain illuminated after restarting the hybrid system, Adaptive Cruise Control cannot be used. This will not interfere with ordinary driving. However, contact a SUBARU dealer and have the system inspected.
⇒ Page 108
- If the EyeSight operation has temporarily stopped, the Pre-Collision Braking System OFF indicator light and Lane Departure Warning OFF indicator light illuminate, and  (EyeSight temporary stop indicator: White) is displayed on the combination meter display.
⇒ Page 109
- When the operation of Adaptive Cruise Control has been automatically canceled, perform the Adaptive Cruise Control setting operation again after the condition that caused the cancellation has been corrected. If the Adaptive Cruise Control function cannot be activated even after the condition has been corrected, EyeSight may be malfunctioning. This will not interfere with ordinary driving. However, contact a SUBARU dealer and have the system inspected.

Restoring the previously set vehicle speed

The previously set vehicle speed is stored in memory. To restore that vehicle speed, press the RES/SET switch to the “RES/+” side.  (Adaptive Cruise Control indicator) changes from white to green.

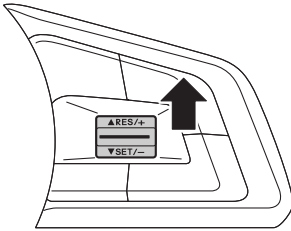

S03395

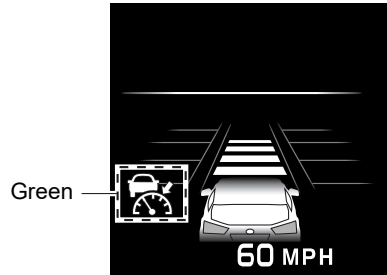

S03172



NOTE

- The vehicle speed stored in memory is erased in the following circumstances:
 - The cruise control is turned off by pressing the  (CRUISE) switch.
 - Vehicle Dynamics Control or Traction Control Function is activated.
 - The cruise control mode was switched from Adaptive Cruise Control to Conventional Cruise Control.
 - If there is no vehicle speed stored in memory (previous vehicle speed), the current vehicle speed is set when the RES/SET switch is pressed to the “RES/+” side.
- ⇒ Page 52

Turning off Adaptive Cruise Control

When Adaptive Cruise Control is not active, press the  (CRUISE) switch.

 (Adaptive Cruise Control indicator) turns off on the EyeSight display area.

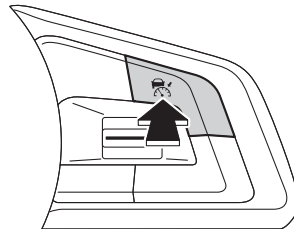

S03393

Other functions

■ “Obstacle Detected” warning

The “Obstacle Detected” warning is activated while Adaptive Cruise Control is following a lead vehicle. This function warns the driver when it determines that the current level of deceleration by automatic braking control is insufficient.

- When the system determines that the vehicle speed needs to be reduced manually by the driver, an alert will sound repeated short beeps and an interruption screen will be displayed.
- When this function activates, depress the brake pedal to decelerate and maintain an optimal following distance.

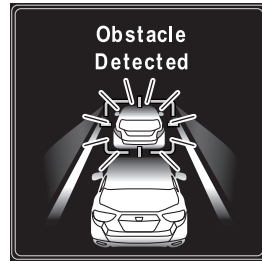

S03176



WARNING

- If the alert/notification sounds frequently, do not use Adaptive Cruise Control.
- The “Obstacle Detected” warning will not activate in the following situations.
 - The accelerator pedal is depressed.
 - The brake pedal is depressed.
- Even when the following distance is short, the “Obstacle Detected” warning may not activate in the following situations.
 - The difference in speed with the vehicle in front is small. The two vehicles are traveling at almost the same speed.
 - The vehicle in front is traveling faster than your vehicle. The following distance is gradually increasing.
 - Another vehicle cuts into your lane very close to your vehicle.
 - The vehicle in front decelerates suddenly.
 - There are repeated uphill and downhill grades.
- The “Obstacle Detected” warning may not activate in time in the case of a vehicle that is stopped at the end of a line at a toll gate, at a stop light or intersection or in traffic congestion, or a vehicle that is moving much slower than your vehicle. EyeSight requires a speed differential in order to recognize a potential obstacle and react to it.



NOTE

Vehicles in front in the same traffic lane are detected by the stereo camera within a distance of approximately 360 ft (110 m) in the forward direction. However the detection distance may be reduced depending on the traffic environment, driving conditions, and conditions of the vehicle in front.

Lane Keep Assist

The stereo camera detects lane markings (including Botts' dots) of the lane and the system assists the steering operation by working with the electric power steering to help keep your vehicle in its lane when driving on expressways, freeways and interstate highways.

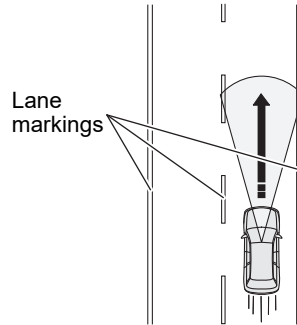

H00668



WARNING

Lane Keep Assist is not an automatic driving system.

Do not overestimate the capabilities of Lane Keep Assist. It is not a system to assist inattentive driving or meant to permit driving without holding the steering wheel. Make sure to grip the steering wheel while driving. To drive safely, check the distance from the vehicle in front or from a vehicle driving in parallel with your vehicle, the surrounding conditions and the surrounding environment while driving.

If you feel that the level of control and timing by the system are different from your own driving style, the system may not support safe driving. Do not use Lane Keep Assist.

Lane Keep Assist does not always operate under all situations. If you rely only on Lane Keep Assist to stay in a lane, it may cause an accident such as a collision with an obstacle beside your lane or with a vehicle driving in an adjacent lane.

- Check that there are no problems with the tires and brakes during a daily inspection before using the system.
⇒ Refer to "Warranty and Maintenance Booklet".

Continued on next page ⇒

⇒ Continued from previous page

- The system may not operate properly under the following conditions. Do not use Lane Keep Assist.
 - The air pressure of tires is not to specification.*¹
 - Tires that are unevenly worn or tires with uneven wear patterns are installed.*¹
 - Tires that are the wrong size are installed.*¹
 - The wheels are out of balance (e.g., the balance weight is removed or misaligned).*¹
 - The wheels are out of alignment.*¹
 - A flat tire has been fixed temporarily with a tire repair kit.
 - The suspension has been modified (including genuine SUBARU parts).
 - An object that obstructs the stereo camera's view is installed on the vehicle.
 - Tire chains are installed.
 - There is an abnormal vibration in the steering wheel or the steering wheel is heavier than usual.
 - The steering wheel has been replaced with parts other than genuine SUBARU parts.
 - The headlights are dirty or they have snow, ice or dirt on them. (Objects are not adequately illuminated and are difficult to detect.)
 - The headlights are not aligned correctly. (Objects are not adequately illuminated and are difficult to detect.)
 - The headlights, fog lights and other lights have been modified.
 - Vehicle operation has become unstable due to an accident or malfunction.
 - The brake system warning light is illuminated in red.*²
 - A heavy cargo is loaded onto or inside the vehicle.
 - The maximum number of occupants is exceeded.
 - A trailer or another vehicle, etc. is being towed.
 - The combination meter is not operating properly. For example, an indicator light or a warning light on the combination meter does not properly turn on or off, a beep does not sound, or the indication on the combination meter display is different from when it is normal.*³
- *1: The wheels and tires have functions that are critically important. Be sure to use the correct ones.
For details, refer to the vehicle Owner's Manual.
- *2: If the brake system warning light does not turn off, immediately pull the vehicle over in a safe place and contact a SUBARU dealer to have the system inspected. For details, refer to the vehicle Owner's Manual.
- *3: For details about the functions and operations of the combination meter, refer to the vehicle Owner's Manual.

- Lane Keep Assist is designed for use on expressways, freeways, toll roads, interstate highways and similar limited access roads. It is not intended to be used in city traffic. In the following conditions, do not use Lane Keep Assist. Doing so may result in an accident.

- Ordinary roads (roads other than those mentioned above)
Depending on the driving environment (complexity of roads and other factors), the system may not be able to perform as the traffic conditions require, and that may result in an accident.
- Roads with sharp curves
- Roads with lane restrictions or tentative lanes due to construction work, etc.
- Old lane markings remain.
- Avoiding parked vehicles
- Snow, puddles or snow melting agents remain on the road surface.
- Cracks or constructed traces remain on the road surface.
- Frozen roads, snow-covered roads or other slippery road surfaces

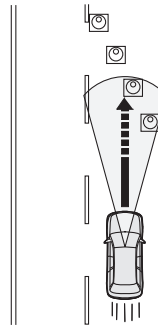

H00463

- The tires may spin, causing loss of control of the vehicle.
- Entering a sharp curve into an interchange or junction, or a service area, parking area, toll booth or other facilities
- There are changes in brightness, such as at a tunnel entrance or exit.
- Visibility is poor due to sand, smoke or water vapor blowing in the wind, or the front vision is obscured due to water splashes, snow, dirt or dust stirred up generated by the vehicle in front or oncoming traffic.
- The windshield has become fogged, scratched or smeared, or snow, dirt, dust or frost has adhered to it, or it is otherwise affected. These will reduce the stereo camera's field of view. Also, light is reflecting off the dirt, etc.
- Rain or dirt has not been fully wiped off of the windshield. There is a risk of that the stereo camera may not detect the lanes.
- The stereo camera's field of view is obstructed (for example by a canoe on the roof of the vehicle).

Continued on next page ⇒

⇒ Continued from previous page

- The stereo camera may have difficulty detecting the lane markings under the following conditions and the system may not operate properly.
 - At night or in a tunnel without the headlights on
 - Light is poor in the evening or early morning.
 - In bad weather (for example, rain or snow)
 - The road surface is wet and shining by reflected sunlight.
 - The distance between your vehicle and the vehicle in front is short, making it difficult to detect lane markings.
 - A vehicle intruded from an adjacent lane or the vehicle in front changed lanes.
 - The shape of a curve in the road suddenly changes.
 - Shadows of guardrails or similar objects are overlapped on the lane markings.
 - Strong light is coming from the front (sunlight or headlight beams of oncoming traffic, etc.).
 - The width of a lane is either too narrow or too wide.
 - The width of a lane has changed.
 - The stereo camera may have difficulty detecting the lane due to the performance of the camera.
 - There are no lane markings or they are very worn.
 - The lane markings are painted in yellow.
 - The lane markings are similar in color to the road surface.
 - The lane markings are drawn in double.
 - The width of lane markings is narrow.
 - Lines that are not lane markings are painted on roads.
 - The lane markings are touching the walls and poles.

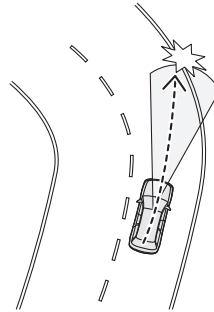

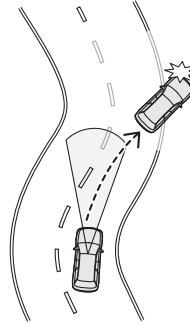

H00465

- The shape of lane markings suddenly changes (entrance/exit of a curve, crank and winding road, etc.).
- There is a curb or a side wall on the road shoulder.
- The brightness changes such as when you drive under an overpass.



H00464

CAUTION

- The performance of Lane Keep Assist may not be optimal under the following conditions. In addition, Lane Keep Assist may not operate or the operation may be canceled.
 - Immediately after the weight of your vehicle changes radically
 - Immediately after the replacement of a tire or the adjustment of tire pressure
 - Immediately after the adjustment, repair or replacement of the camera or related components
 - Immediately after the repair or replacement of the suspension or steering system
 - A winter tire or a tire other than a genuine SUBARU tire is used.
 - The vehicle is in a crosswind.
 - The road grade abruptly changes (uphill or downhill).
 - The grade of the crossing direction in a road is large or changes abruptly.
 - Unevenness, winding and joint of a road surface
 - The acceleration/deceleration is high.
 - Immediately after starting the hybrid system when the outside temperature is low.
 - The outside temperature is high.
- When you do not use Lane Keep Assist, make sure to turn off the  (Lane Keep Assist) switch. If the function is left on, the function may operate unexpectedly, causing an accident.
- If you turn on the  (Lane Keep Assist) switch, the operation power of electric power steering may change.

Lane Departure Prevention Function

The system detects lane markings in order to help prevent departure from the lane. If you drive on expressways, freeways or interstate highways at speeds above approximately 37 mph (60 km/h) and the vehicle is about to depart from the lane, the system assists the steering operation by turning it to the direction that will help prevent the lane departure.

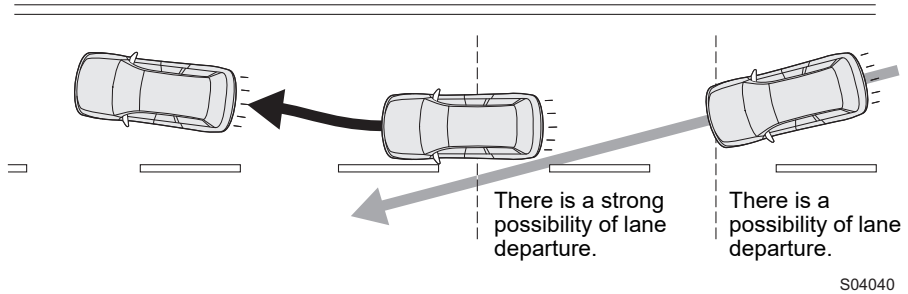

■ How to use Lane Departure Prevention Function

Press the  (Lane Keep Assist) switch.

Lane Keep Assist is turned on, and  (Lane Keep Assist indicator) (white) and lane indicator (gray) are displayed on the EyeSight display area of the combination meter display.

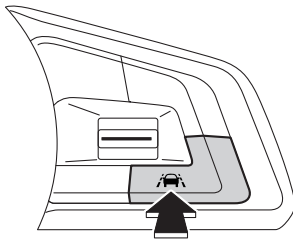

S03456

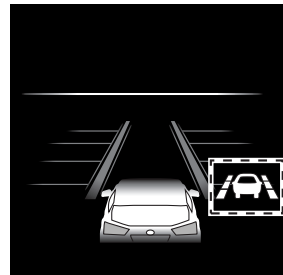

Lane Keep Assist indicator (white)

S03284

Lane Departure Prevention Function goes into the standby status, and the lane indicator (white) illuminates when all of the following conditions are met.

- The vehicle speed is between approximately 37 mph (60 km/h) and 90 mph (145 km/h).
- The system is detecting the lane markings.
- The driver is operating the steering wheel.
- On a road that has a lane width that is between approximately 10 ft (3 m) and 15 ft (4.5 m)
- On a straight road or gentle curve
- Driving near the center of a lane

When the vehicle is about to depart from the lane, Lane Departure Prevention Function starts to operate and  (Lane Keep Assist indicator) turns from white to green while it is operating.

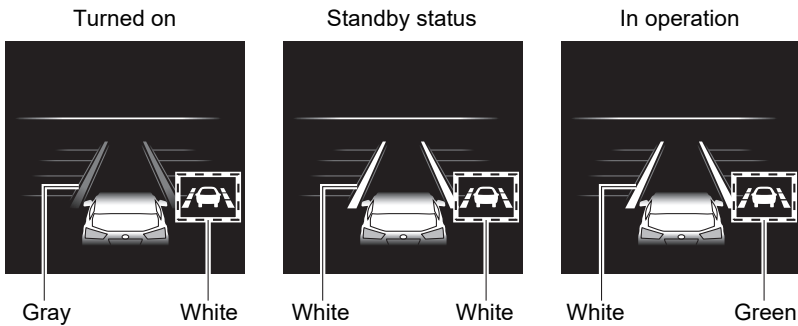

S03781



NOTE

- If you just lightly put your hands on the steering wheel for a certain period of time or if you do not operate the steering wheel, the function will temporarily be canceled.  (Lane Keep Assist indicator) illuminates in white again. Also, the Lane Keep Assist cancellation message is displayed on the screen.
- Lane Departure Prevention Function operates when the system determines that the vehicle will depart from the lane if you continue to drive in the same manner. Therefore, it operates at an earlier timing than Lane Departure Warning (⇒ page 84). It may depend on the surrounding environment and road condition.
- The lane indicator in the standby status and in operation may illuminate only on the left side or right side.
- The on/off status of Lane Keep Assist is restored when you restart the hybrid system.

■ Canceling Lane Departure Prevention Function

● Canceling by driver operation

Any of the following operations temporarily cancels Lane Departure Prevention Function.

While temporarily canceling this function,  (Lane Keep Assist indicator) on the EyeSight display area illuminates in white and the lane indicator turns to gray.

- Depressing the brake pedal strongly
- Operating the turn signal lever
- The system determines that the driver operates the steering wheel to make a lane change.
- Turning on the hazard warning flasher switch

● Automatic cancellation by the system

Under the following conditions, a notification will sound 1 short beep and 1 long beep and Lane Departure Prevention Function is temporarily canceled.

While the function is temporarily canceled,  (Lane Keep Assist indicator) on the EyeSight display area illuminates in white and the lane indicator turns to gray. Also, the Lane Keep Assist cancellation message is displayed on the combination meter display.

- The system does not detect the lane markings.
- The windshield wiper operates at a high speed.
- The vehicle speed is less than approximately 34 mph (55 km/h) or is more than approximately 93 mph (150 km/h).
- Vehicle Dynamics Control or Traction Control Function is activated.
- Either the driver's door, the front passenger's door or the rear door is open.
- The driver's seatbelt is unfastened.
- The electronic parking brake is applied.
- The select lever is moved to a position other than "D" or "B".
 - Lane Departure Prevention Function can be resumed after the select lever is returned to the "D" or "B" position.

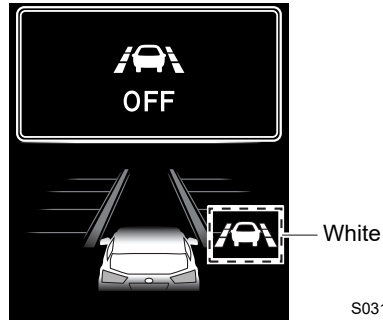



S03179

- The system does not detect steering operation by the driver for a certain period of time.

- When the system detects no steering operation, the interruption screen appears on the combination meter display. The interruption screen continues to appear until the system detects the steering operation. If the system still does not detect the steering operation, Lane Departure Prevention Function is temporarily canceled.



S03589

- Entering a sharp curve
- On a sharp curve
- Due to the road conditions
- Due to another system operating
- The EyeSight system has a malfunction.  (EyeSight warning indicator: Yellow)
⇒ Page 108
- The EyeSight system has stopped temporarily.  (EyeSight temporary stop indicator: White)
⇒ Page 109



NOTE

If the function is automatically canceled during the standby status ( (Lane Keep Assist indicator) illuminates in white), no beep sounds.

■ Turning off Lane Departure Prevention Function

Press the  (Lane Keep Assist) switch.

 (Lane Keep Assist indicator) and lane indicator are turned off on the EyeSight display area.

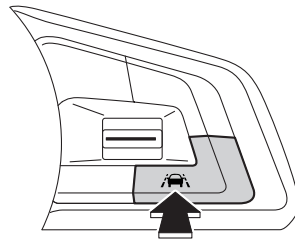

S03456

Pre-Collision Throttle Management

When an obstacle is detected in front of the vehicle, and the vehicle is stopped or traveling very slowly, if the system determines that the accelerator pedal has been depressed by more than the necessary amount (due to driver error), it greatly restricts hybrid system output and ensures that vehicle forward movement is slower than normal in order to give the driver additional time to brake or react.

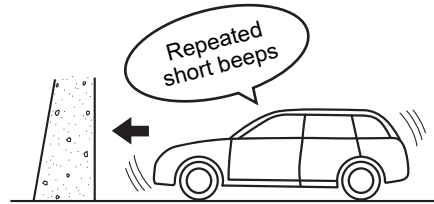

H00440

During system operation, an alert will sound repeated short beeps and an interruption screen will be displayed.

This function only activates when the select lever is in the "D" or "B" position.

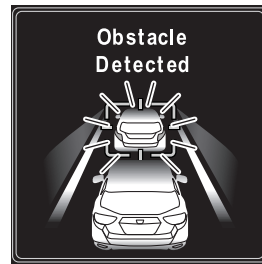

S03176



WARNING

Do not rely excessively on Pre-Collision Throttle Management. Pre-Collision Throttle Management is not designed to help you avoid collisions in all situations. Always check the select lever and pedal positions as well as the surrounding environment before starting and operating the vehicle. Relying only on Pre-Collision Throttle Management could result in an accident.

- Pre-Collision Throttle Management is not designed to maintain the vehicle in a stopped condition.
- Pre-Collision Throttle Management will not reduce acceleration under all conditions. It is also not designed to prevent collisions.
- Pre-Collision Throttle Management will operate when an obstacle is detected in front. However, this function will not reduce acceleration in cases where no obstacle is detected (for example when approaching a cliff, etc.).

- Do not intentionally depress the accelerator pedal excessively when there are obstacles nearby. If the driver relies only on Pre-Collision Throttle Management to control acceleration, collisions may occur.
- If your vehicle is trapped on a railroad crossing and you are trying to escape by driving through the crossing gate, the stereo camera may recognize the crossing gate as an obstacle and Pre-Collision Throttle Management system may activate. In this case, remain calm and either continue to depress the accelerator pedal or turn off the Pre-Collision Throttle Management system.
⇒ Page 83
- Pre-Collision Throttle Management may not activate depending on the following conditions:
 - The distance between your vehicle and the obstacle, speed difference, and horizontal offset
 - Recognition status of the stereo camera
In particular, the function may not activate in the following cases:
 - Bad weather (for example heavy rain, a blizzard or thick fog)
 - Visibility is poor due to sand or smoke in the air.
 - Light is poor in the evening, early morning, or at night.
 - In a dark area (indoor parking area, etc.)
 - There is an obstacle outside the area illuminated by the headlights.
 - Strong light is coming from the front (for example sunlight at sunrise or sunset headlight beams, etc.).
 - The windshield has become fogged, scratched or smeared, or snow, dirt, dust or frost has adhered to it, or it is otherwise affected. These will reduce the stereo camera's field of view. Also, light is reflecting off the dirt, etc.
 - Fluid has not been fully wiped off the windshield during or after use of the window washer.
 - Obstacles cannot be correctly recognized due to water droplets from rain or the washer, or the wiper blades obstructing the stereo camera's field of view.
 - The stereo camera's field of view is obstructed (for example by a canoe on the roof of the vehicle).
 - With low obstacles (low wall, crash barrier, low vehicle, etc.)
 - The size and height of an obstacle is smaller than the limitations of the stereo camera's recognition capability.
 - With small animals or children
 - With pedestrians who are sitting or lying down

Continued on next page ⇒

⇒ Continued from previous page

- The rear portion nearest your vehicle is too small or too close (such as a trailer or oncoming vehicle). The system may not recognize the part of that vehicle which is closest to you.

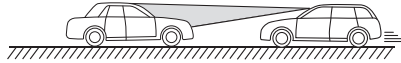
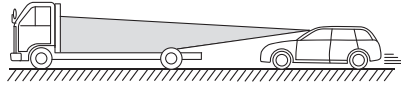

S02134

- There is a fence or wall, etc., with a uniform pattern (striped pattern, brick, etc.) or with no pattern in front.
- There is a wall or door made of glass or a mirror in front.
- An obstacle (another vehicle, motorcycle, bicycle, pedestrian, animal or child, etc.) cuts in from the side or jumps out suddenly.
- Your vehicle is immediately behind an obstacle after changing lanes.
- On sharp curves, steep uphill grades or steep downhill grades
- The system determines that steering operation by the driver is intended as evasive action.
- For your safety, do not test Pre-Collision Throttle Management on its own. It may operate improperly and cause an accident.

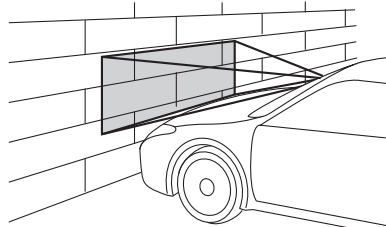

S00653

CAUTION

- In the following situations, turn off Pre-Collision Throttle Management. Otherwise Pre-Collision Throttle Management may activate unexpectedly.

⇒ Page 83

- The vehicle is being towed.
- The vehicle is being loaded onto a carrier.
- A chassis dynamometer, free-rollers or similar equipment is being used.
- A mechanic lifts up the vehicle, starts the hybrid system and allows the wheels to spin freely.
- Driving on a race track
- Passing hanging banners, flags or branches
- Thick/tall vegetation is touching the vehicle.
- Pre-Collision Throttle Management may activate in the following situations. Therefore concentrate on safe driving.
 - Your vehicle is close to the vehicle in front.
 - Passing through an automatic gate
 - Your vehicle is in a location where the grade of the road changes rapidly.

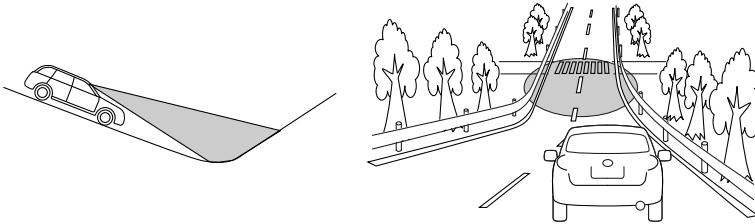

S01264

- Passing through clouds of steam or smoke

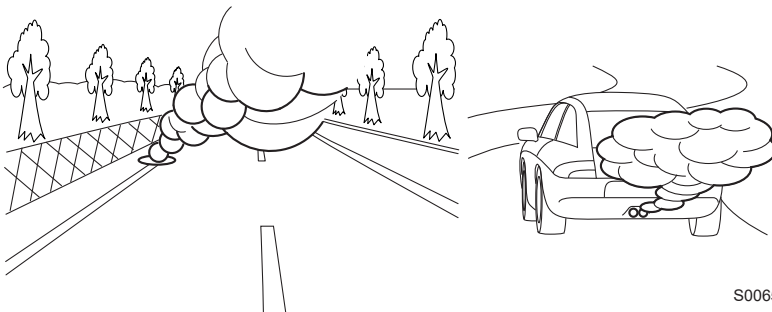

S00652

Continued on next page ⇒

⇒ Continued from previous page

- Passing through water spray from road sprinklers or snow clearing sprinklers on the road

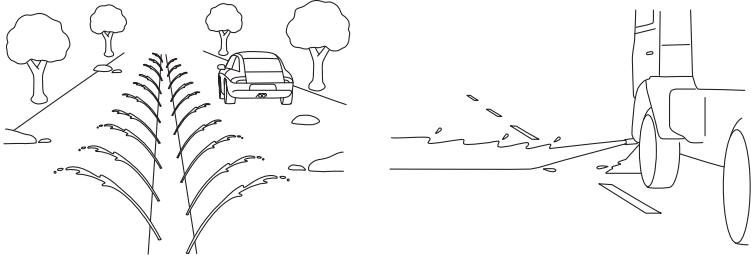

S02636

- In adverse weather, such as heavy snow or snowstorms
- There is an obstacle on a curve or intersection.
- A vehicle or an object is being narrowly passed.
- Stopping very close to a wall or a vehicle in front

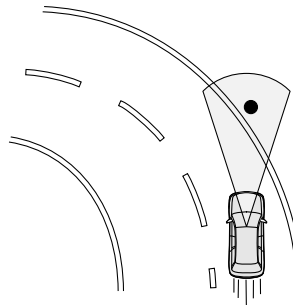

S02669



NOTE

- When the accelerator pedal is depressed for approximately 3 seconds, Pre-Collision Throttle Management will be released gradually.
- When Pre-Collision Braking System is turned off, Pre-Collision Throttle Management is also turned off.

⇒ Page 41

Turning off Pre-Collision Throttle Management

Press and hold the Pre-Collision Braking System OFF switch for approximately 2 seconds or longer to turn off Pre-Collision Throttle Management System. When 1 short beep sound emits, this function is turned off and the Pre-Collision Braking System OFF indicator light on the instrument panel illuminates.

To turn the system back on, press and hold the Pre-Collision Braking System OFF switch again for approximately 2 seconds or longer. When this function is turned on, the Pre-Collision Braking System OFF indicator light turns off.

⇒ Page 42

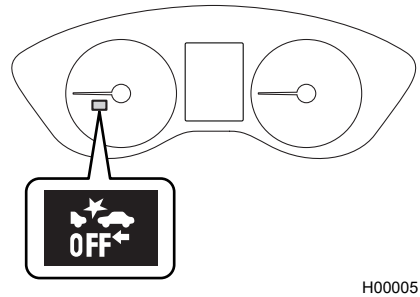
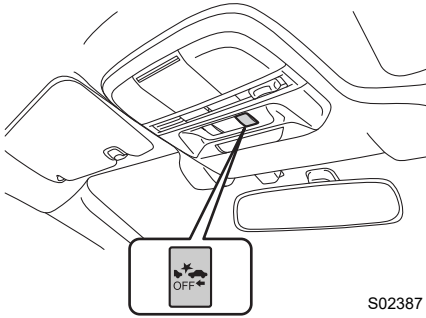

NOTE

- When Pre-Collision Throttle Management is turned off, Pre-Collision Braking System also turns off.
- Even when Pre-Collision Throttle Management is turned off, if the hybrid system is turned off and then restarted, Pre-Collision Throttle Management will be turned on. The system default setting when the vehicle is restarted is on.

Lane Departure Warning

When vehicle speed is approximately 30 mph (50 km/h) or more, this function warns the driver if the system detects that the vehicle is likely to depart the traffic lane.

When Lane Departure Warning activates, an alert sounds 3 short beeps and an interruption screen will be displayed.

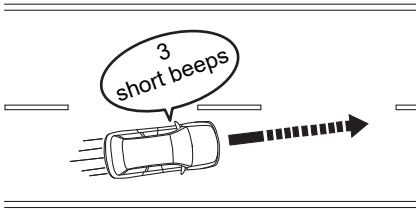

S03878



S02408

*: The illustration depicts a vehicle about to cross the left line.



WARNING

Lane Departure Warning will not operate in all conditions. It also will not automatically return the vehicle to the original lane. If the driver relies only on Lane Departure Warning to keep the vehicle in the lane, lane departure may occur, resulting in an accident.

Lane Departure Warning activates when it detects lane markings. However, it is not a function which can detect the edge of a road (shoulders or side ditches, etc.) and warn the driver.

CAUTION

In the following situations, Lane Departure Warning may not activate:

- Vehicle speed is approximately 30 mph (50 km/h) or less.
- The steering wheel is turned significantly to either side.
- The vehicle is driving around a curve whose radius is 0.18 miles (300 m) or smaller.
- The brake pedal is depressed or immediately after it is depressed.
- The following distance behind a vehicle in front is short.
- The turn signal is operating.
- For approximately 4 seconds after the turn signal lever has returned to its original position
- The vehicle has not returned to the inside of the lane after Lane Departure Warning has activated.
- The lane is narrow.
- It is difficult for the camera to detect lane markings.
 - There are no lane markings or they are very worn.
 - The lane markings are yellow.
 - The lane markings are similar in color to the road surface.
 - The lane markings are narrow.



NOTE

- The following situations may cause incorrect lane detection and a faulty Lane Departure Warning to occur.
 - There are tire tracks on a wet road or snow-covered road.
 - There are boundaries between snow and asphalt, or marks from road repair, etc.
 - There are the shadows of guardrails.
 - Lane markings are drawn in double.
 - There are some lane markings left from roadwork or markings from the previous road.
 - When the Lane Departure Warning OFF indicator light is illuminated, Lane Departure Warning is inactive.
- ⇒ Page 87

Turning off Lane Departure Warning

Press and hold the Lane Departure Warning OFF switch for approximately 2 seconds or longer to turn off Lane Departure Warning. When 1 short beep sound emits, this function is turned off and the Lane Departure Warning OFF indicator light on the instrument panel will illuminate.

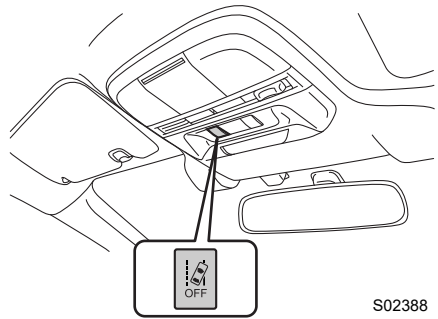
To turn the function back on, press and hold the Lane Departure Warning OFF switch again for approximately 2 seconds or longer. When the function is turned on, the Lane Departure Warning OFF indicator light turns off.



NOTE

- When Lane Departure Warning is turned off, Lane Sway Warning is also turned off.
- The on/off status of Lane Departure Warning is restored when you restart the hybrid system.

■ Lane Departure Warning OFF indicator light

This indicator light illuminates when the ignition switch is turned to the ON position, and then approximately 7 seconds after the hybrid system starts, it turns off or remains illuminated depending on the current status (ON or OFF). It illuminates when Lane Departure Warning and Lane Sway Warning are turned off.

It also illuminates under the following conditions.

- The EyeSight system has a malfunction.

 (EyeSight warning indicator: Yellow)

⇒ Page 108

- The EyeSight system has stopped temporarily.  (EyeSight temporary stop indicator: White)

⇒ Page 109

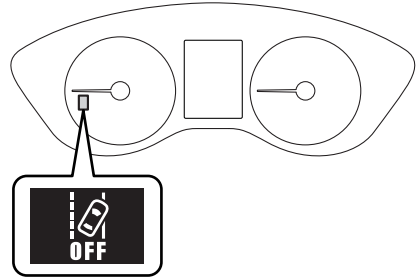

H00006

Lane Sway Warning

This function detects swaying or drifting within a lane, and warns the driver. When Lane Sway Warning activates, an alert sounds 3 short beeps and an interruption screen will be displayed.

This function activates when the vehicle speed exceeds approximately 37 mph (60 km/h) and deactivates when the vehicle speed falls below approximately 25 mph (40 km/h). The function will reactivate when the vehicle speed is increased to exceed approximately 37 mph (60 km/h).

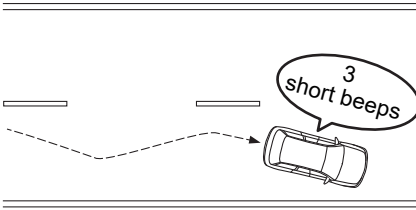

S03879



S02410

*: The lines on the right and left blink alternately.



WARNING

Lane Sway Warning will not operate in all conditions. It also will not automatically correct swaying. If the driver relies only on Lane Sway Warning to prevent the vehicle from swaying, an accident may occur.

CAUTION

Under the following conditions, Lane Sway Warning may not operate.

- On a winding road
- The vehicle speed changes greatly.
- Immediately after a lane change
- It is difficult for the EyeSight stereo camera to detect lane markings.
 - There are no lane markings or they are the very worn.
 - The lane markings are yellow.
 - The lane markings are similar in color to the road surface.
 - The lane markings are narrow.

NOTE

- Swaying detection is based on several minutes of prior driving data. Swaying will not be detected immediately after the vehicle starts to sway. In addition, the warning may continue for some time even after swaying stops.
- Lane Sway Warning is just a function that warns the driver. When the driver is tired, not concentrating on the road or not paying adequate attention to driving, be sure to take rest breaks as often as needed.
- Under the following conditions, Lane Sway Warning will not operate.
 - Lane Keep Assist is operated.
 - ⇒ Page 69
 - The Lane Departure Warning OFF indicator light is illuminated.
 - ⇒ Page 87

Turning off Lane Sway Warning

Press and hold the Lane Departure Warning OFF switch for approximately 2 seconds or longer to turn off Lane Sway Warning. When 1 short beep sound emits, this function is turned off and the Lane Departure Warning OFF indicator light on the instrument panel illuminates.

To turn the function back on, press and hold the Lane Departure Warning OFF switch again for approximately 2 seconds or longer. When the function is turned on, the Lane Departure Warning OFF indicator light turns off.

⇒ Page 87

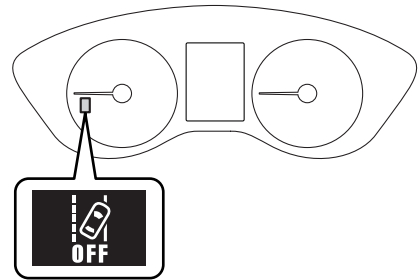
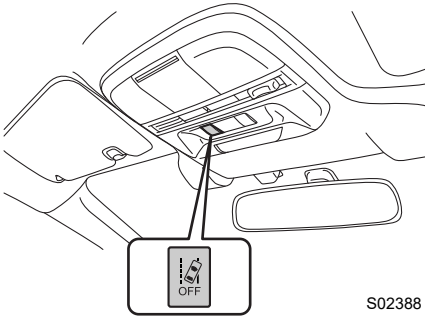

NOTE

- When Lane Sway Warning is turned off, Lane Departure Warning is also turned off.
- The on/off status of Lane Sway Warning is restored when you restart the hybrid system.

Lead Vehicle Start Alert

When the vehicle stopped in front starts to move, Lead Vehicle Start Alert notifies the driver by an interruption screen on the combination meter display and notification sound. When the vehicle in front remains stopped continuously (within a following distance of approximately 32 ft (10 m) and the driver's vehicle remains stopped for several seconds or longer), the system continues to detect the vehicle in front and this alarm activates if the vehicle in front advances approximately 10 ft (3 m) or more while the driver's vehicle remains stationary.

This function only activates when the select lever is in the "D", "N" or "B" position.

When Lead Vehicle Start Alert activates, a notification sounds a two-tone beep and an interruption screen will be displayed.

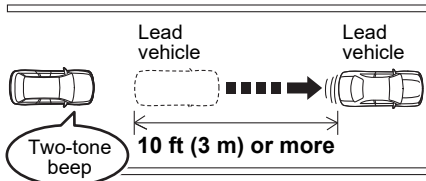

H00462

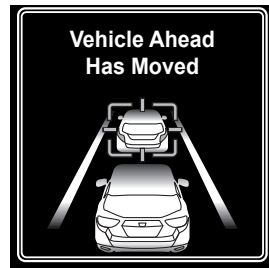

S02411





WARNING

Even after alerts are given audibly and through an interruption screen, be sure to carefully check the area surrounding the vehicle before pulling away. Relying solely on Lead Vehicle Start Alert may result in an accident.



NOTE

- The Lead Vehicle Start Alert setting can be turned on or off.
⇒ Page 111
- Under the following conditions, Lead Vehicle Start Alert may activate even when the vehicle in front has not started to move, or may not activate even after the vehicle in front has started to move:
 - A motorcycle or similar object cuts in between your vehicle and the stopped vehicle in front.
 - Weather or road conditions may interfere with the detection of the vehicle in front.
 - The EyeSight stereo camera loses detection of the vehicle in front.
- Under the following conditions, Lead Vehicle Start Alert will not activate.
 - The EyeSight system has a malfunction.  (EyeSight warning indicator: Yellow)
⇒ Page 108
 - The EyeSight system has stopped temporarily.  (EyeSight temporary stop indicator: White)
⇒ Page 109

Driver Assist indicator

The operating status of the EyeSight system is indicated at the top of the combination meter.

This allows the driver to remain aware of warnings and displayed information without taking their eyes off the surrounding driving environment.

The LED indicators can be set to On/Off. Refer to “Customizing functions” for setting details.

⇒ Page 111

Driver Assist indicator operation

To inform the driver of the operation condition of EyeSight while driving, the LED indicators illuminate or blink at the top of the combination meter.

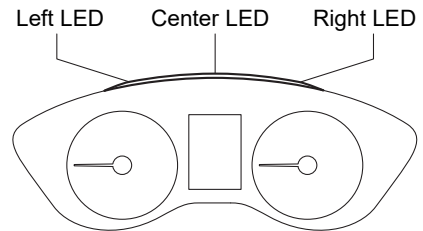

S03365

Display	Condition
Red indicators blink simultaneously (3 indicators)	The Following Distance Warning, Pre-Collision Braking System (first braking or secondary braking), “Obstacle Detected” warning or Pre-Collision Throttle Management is operating.
Yellow indicator blinks (one side)	Lane Departure Warning is operating. The side where the vehicle has left its lane blinks, and the side that has not left its lane illuminates.
Yellow indicators blink (alternately)	Lane Sway Warning is operating.
Yellow indicators blink simultaneously	Steering wheel operation is not detected for a certain period of time.
Green indicator illuminates	Adaptive Cruise Control is activated.

Conventional Cruise Control

Conventional Cruise Control is a driving support system intended to allow more comfortable driving on expressways, freeways and interstate highways. It can be used to travel at a constant speed by maintaining the vehicle speed set by the driver. Please remember that you should not exceed posted speed limits.





WARNING

- When Conventional Cruise Control is functioning, the system does not perform the following control to maintain a following distance, as when using Adaptive Cruise Control.
Strive for safe driving and depress the brake pedal to decelerate the vehicle as necessary in order to ensure a safe following distance from the vehicle in front.
- Under the following conditions, do not use Conventional Cruise Control. Doing so may result in an accident.
 - Roads with heavy traffic or roads with sharp curves
Maintaining an appropriate speed for such road conditions may be difficult.
 - Frozen roads, snow-covered roads or slippery road surfaces
The tires may spin, causing your vehicle to lose control.
 - Steep downhill grades
The set vehicle speed may be exceeded.
 - On a steep continuous downhill grade
The brakes may overheat.
- When using Conventional Cruise Control, always set the speed according to the speed limit, traffic flow, road conditions, and other conditions.





CAUTION

When using Cruise Control, be sure to check the EyeSight display area to confirm which Cruise Control mode is selected: Adaptive Cruise Control or Conventional Cruise Control.

- If Adaptive Cruise Control is selected,  (Adaptive Cruise Control indicator) illuminates.
- If Conventional Cruise Control is selected,  (Conventional Cruise Control indicator) illuminates.



**NOTE**

- When the main cruise control is off and the  (CRUISE) switch is pressed, Adaptive Cruise Control is activated.
- When the main cruise control is on, switching between Adaptive Cruise Control and Conventional Cruise Control is possible by pressing the  /  (Following distance setting) switch*.
 - *: To switch to Conventional Cruise Control, press and hold the switch for approximately 2 seconds or longer.
- Conventional Cruise Control can be used even when EyeSight is temporarily stopped.

How to use Conventional Cruise Control

■ Setting Conventional Cruise Control

(1) Setting Adaptive Cruise Control to standby status

Press the  (CRUISE) switch. At this time,  (Adaptive Cruise Control indicator) (white) and the following distance setting indicator are displayed on the EyeSight display area of the combination meter display. The set vehicle speed display will read "-- MPH (-- km/h)".

When the  (CRUISE) switch is pressed, the initial cruise control mode is always Adaptive Cruise Control.

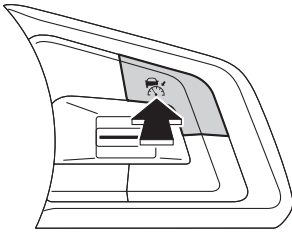

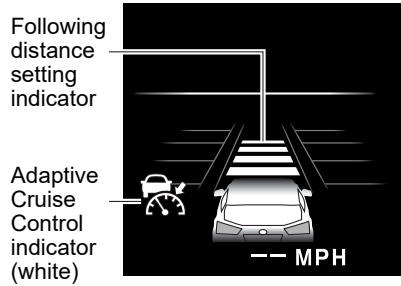

S03393



S03067

(2) Switch to Conventional Cruise Control.

Press and hold the  /  (Following distance setting) switch for approximately 2 seconds or longer to switch from Adaptive Cruise Control to Conventional Cruise Control. A notification sounds 1 short beep.

At this time, the following distance setting indicator on the EyeSight display area of the combination meter display turns off and  (Conventional Cruise Control indicator) (white) is displayed.

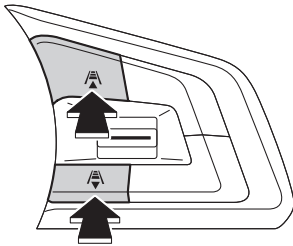

S03397

Conventional Cruise Control indicator (white)

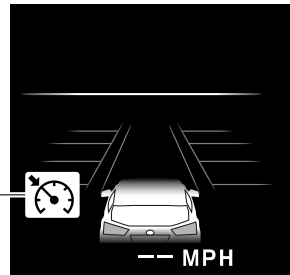

S03117

To set the ready status:

Conventional Cruise Control can be activated when all of the following conditions are met and **READY** (READY indicator) is displayed on the EyeSight display area.

- All doors (except the rear gate) are closed.
- The driver's seatbelt is fastened.
- The electronic parking brake is not engaged. The electronic parking brake indicator light is turned off.
- The select lever is in the "D" position.
- The brake pedal is not depressed.
- The road is not on a steep slope.
- The steering wheel has not been turned significantly in either direction.
- The X-MODE is not turned on (the X-MODE indicator goes off).
- The vehicle speed is between approximately 20 mph (30 km/h) and 90 mph (145 km/h).

READY indicator

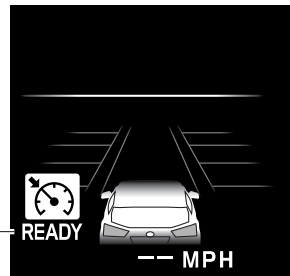

S02711

(3) Control the accelerator pedal to reach the desired speed.

- (4) When the vehicle reaches the desired speed, press the RES/SET switch to the “RES/+” side or the “SET/-” side. The vehicle speed at the time when the switch is pressed will become the set vehicle speed, and constant speed driving will initiate.

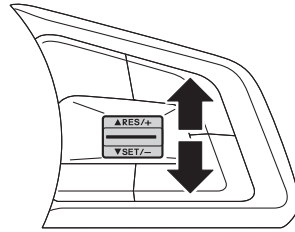

S03394

When Conventional Cruise Control is activated, **READY** (READY indicator) turns off, the set vehicle speed is displayed and  (Conventional Cruise Control indicator) changes from white to green.

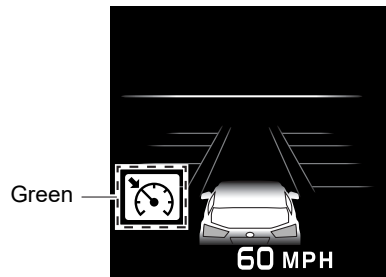

S03180



 **WARNING**

- The “Obstacle Detected” warning will not activate while Conventional Cruise Control is functioning.
- When using Conventional Cruise Control, always set the speed according to the speed limit, traffic flow, road conditions, and other conditions.

 **CAUTION**

During Conventional Cruise Control use, accelerator and brake control to follow the vehicle in front is not performed. Operate the accelerator and brake pedals as necessary.

**NOTE**

- On a downhill grade, automatic braking may operate in order to maintain the set vehicle speed.
- When driving on a curve, the vehicle may not accelerate, or may decelerate, even if the set vehicle speed is higher than the current vehicle speed.
- To return to Adaptive Cruise Control use, cancel Conventional Cruise Control and then briefly press the  /  (Following distance setting) switch. A notification will sound (1 short beep) when switching to Adaptive Cruise Control.

■ Increasing the set vehicle speed**● Using the RES/SET switch**

- Push to the “RES/+” side briefly.
Every time the switch is pushed, the set vehicle speed will increase to the next 5 mph (5 km/h) increment.
- Push to the “RES/+” side continuously.
While the switch is being pushed, the set vehicle speed will increase in increments of 1 mph (1 km/h).

When operating the switch, the set vehicle speed changes on the combination meter display.

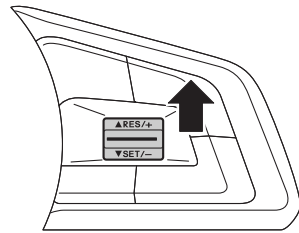

S03395

● Using the accelerator pedal

1. Depress the accelerator pedal to increase vehicle speed.
2. When the desired speed is reached, press the RES/SET switch to the “SET/-” side.
The speed at the time of pressing the switch will be set as the new set vehicle speed, and it appears on the EyeSight display area.

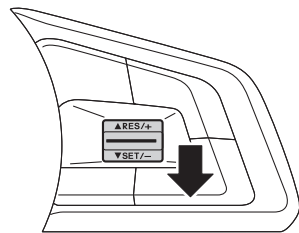

S03396

■ Decreasing the set vehicle speed

● Using the RES/SET switch

- Push to the “SET/-” side briefly.
Every time the switch is pushed, the set vehicle speed will decrease to the next 5 mph (5 km/h) decrement.
- Push to the “SET/-” side continuously.
While the switch is being pushed, the set vehicle speed will decrease in decrements of 1 mph (1 km/h).

When operating the switch, the set vehicle speed changes on the combination meter display.

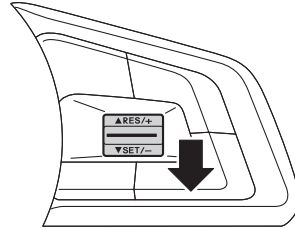

S03396

● Using the brake pedal

1. Depress the brake pedal to decrease the vehicle speed.
Conventional Cruise Control will be canceled and  (Conventional Cruise Control indicator) changes from green to white.
2. When the desired speed is reached, press the RES/SET switch to the “SET/-” side.
The speed at the time of pressing the switch will be set as the new set vehicle speed, and it appears on the EyeSight display area.

■ Accelerating temporarily

Depress the accelerator pedal to accelerate temporarily.

When the accelerator pedal is released, the vehicle returns to the set vehicle speed.

■ Decelerating temporarily

Depress the brake pedal to decelerate temporarily. When the brake pedal is depressed, Conventional Cruise Control will be canceled. While the set vehicle speed remains displayed on the EyeSight display area,  (Conventional Cruise Control indicator) changes from green to white.

Release the brake pedal and press the RES/SET switch to the “RES/+” side to reset the set vehicle speed.

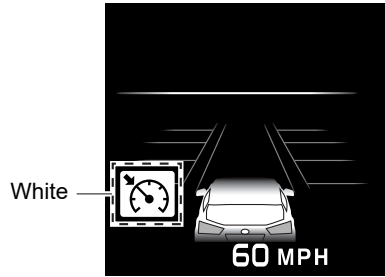

S03181

■ Canceling Conventional Cruise Control

● Canceling by driver operation

Any of the following operations will cancel Conventional Cruise Control.

- Depress the brake pedal.

 (Conventional Cruise Control indicator) changes from green to white while the set vehicle speed remains displayed on the EyeSight display area.

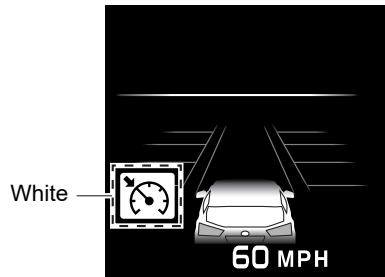

S03181

- Press the  (CRUISE) switch.

 (Conventional Cruise Control indicator) changes from green to white while the set vehicle speed remains displayed on the EyeSight display area.

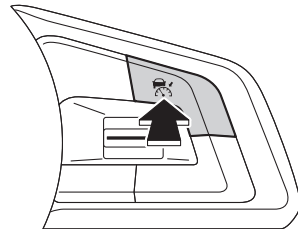

S03393

● Automatic cancellation by the system

In the following cases, a notification sounds 1 short beep and 1 long beep and the cruise control function is automatically canceled.

 (Conventional Cruise Control indicator) changes from green to white. Also, the Conventional Cruise Control cancellation message is displayed on the screen.

After the conditions listed below have been resolved, perform the cruise control set operation again to reactivate cruise control.

- The select lever is moved to a position other than “D”.
 - Conventional Cruise Control can be resumed after the select lever is returned to the “D” position.
- Vehicle speed drops to approximately 16 mph (25 km/h) or less (due to a steep uphill grade or some other reason).
- The X-MODE is turned on (the X-MODE indicator illuminates).
 - Conventional Cruise Control can be resumed after the X-MODE is turned off.
- Vehicle speed increases to approximately 100 mph (160 km/h) or more.
- Vehicle Dynamics Control or Traction Control Function is activated.
- Any door (except the rear gate) is opened.
- The driver’s seatbelt is unfastened.
- The electronic parking brake is engaged.
- The EyeSight system has a malfunction.  (EyeSight warning indicator: Yellow) ⇒ Page 108
- The steering wheel is turned significantly in either direction.
- The grade of the road is steep.
- The Pre-Collision secondary braking is activated.

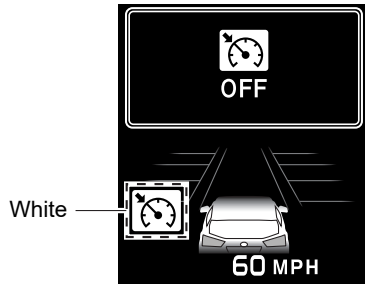

S03183

 **WARNING**

Do not use Conventional Cruise Control on slippery roads. Doing so may result in an accident.

 **CAUTION**

When shifting the select lever to the “N” or “B” position, Conventional Cruise Control will be automatically canceled. Do not shift the lever to the “N” position unless in an emergency. Otherwise the engine brake may not operate, which could cause an accident.

 **NOTE**

- If EyeSight is malfunctioning,  (EyeSight warning indicator: Yellow) is displayed on the combination meter display and the Pre-Collision Braking System OFF indicator light and Lane Departure Warning OFF indicator light illuminate. If this occurs, stop the vehicle in a safe location and then turn off the hybrid system and restart it. If the indicators remain illuminated after restarting the hybrid system, Conventional Cruise Control cannot be used. This will not interfere with ordinary driving. However, contact a SUBARU dealer and have the system inspected.
⇒ Page 108
- When operation of Conventional Cruise Control has been automatically canceled, perform the set operation again after the condition that caused the cancellation has been resolved. If cruise control cannot be activated even after the condition has been corrected, EyeSight may be malfunctioning. This will not interfere with ordinary driving. However, contact a SUBARU dealer and have the system inspected.

■ Restoring the previously set vehicle speed

The previously set vehicle speed is stored in memory. To restore that vehicle speed, press the RES/SET switch to the "RES/+" side.  (Conventional Cruise Control indicator) changes from white to green.

You can restore the set vehicle speed when the previously set vehicle speed has been stored and the current vehicle speed is approximately 20 mph (30 km/h) or more.

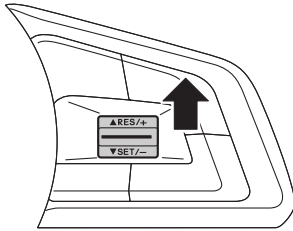

S03395

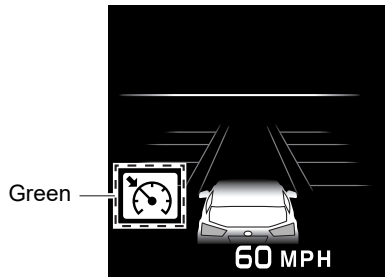

S03180





NOTE

- The vehicle speed stored in memory is erased in the following circumstances:
 - The cruise control is turned off by pressing the  (CRUISE) switch.
 - Vehicle Dynamics Control or Traction Control Function is activated.
 - The cruise control mode was switched from Conventional Cruise Control to Adaptive Cruise Control.
- The vehicle drives constantly and correspondingly to the set vehicle speed between 20 mph (30 km/h) and 90 mph (145 km/h).
- If there is no vehicle speed stored in memory (previous vehicle speed), the current vehicle speed is set when the RES/SET switch is pressed to the "RES/+" side.

⇒ Page 98

■ Turning off Conventional Cruise Control

When Conventional Cruise Control is not active, press the  (CRUISE) switch.

 (Conventional Cruise Control indicator) turns off on the EyeSight display area.

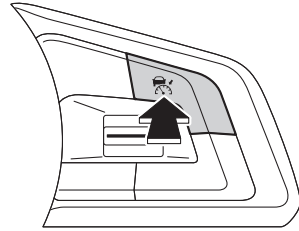

S03393

List of alert/notification sounds

Alert/notification sound	Status	Reference page
Single continuous beep	Pre-Collision Braking System: Secondary Braking is active.	⇒ Page 37
1 short beep and 1 long beep	Adaptive Cruise Control or Conventional Cruise Control is canceled automatically.	⇒ Pages 64 and 102
	The stay-stopped function is canceled and the electronic parking brake is automatically applied.	⇒ Page 64
	Lane Keep Assist is canceled automatically.	⇒ Page 76
Repeated short beeps	Pre-Collision Braking System: First Braking is active.	⇒ Page 37
	Pre-Collision Braking System: The following distance warning is active.	
	The "Obstacle Detected" warning from Adaptive Cruise Control is active.	⇒ Page 67
	Pre-Collision Throttle Management is active.	⇒ Page 78
3 short beeps	Lane Departure Warning is active.	⇒ Page 84
	Lane Sway Warning is active.	⇒ Page 88
1 short beep	Either of the following occurs while Adaptive Cruise Control is activated. - A vehicle in front is detected*. - A vehicle in front is no longer detected*.	⇒ Page 53
	The cruise control mode (Adaptive Cruise Control ↔ Conventional Cruise Control) is changed.	⇒ Pages 97 and 99
	EyeSight is malfunctioning.	⇒ Page 108
	EyeSight operation is temporarily stopped.	⇒ Page 109
	Pre-Collision Braking System and Pre-Collision Throttle Management are turned on/off.	⇒ Pages 41 and 83
	Lane Departure Warning and Lane Sway Warning are turned on/off.	⇒ Pages 86 and 90

Alert/notification sound	Status	Reference page
5 intermittent beeps, 1 short beep and 1 long beep	The stay-stopped function of Adaptive Cruise Control continues for 2 minutes and the electronic parking brake is automatically applied.	⇒ Page 62
Two-tone beep	Lead Vehicle Start Alert is active*.	⇒ Page 91

- *: The notification that indicates when a lead vehicle is detected or when it is no longer detected (Lead Vehicle Acquisition Sound), as well as Lead Vehicle Start Alert can be turned on or off.
⇒ Page 111

EyeSight malfunction and temporary stop

If a malfunction is detected in the EyeSight system, the indicators in the instrument panel and the combination meter display inform the driver of the malfunction. Check the displayed contents and take the appropriate action.

■ Malfunction (including position/angle misalignment of stereo camera)

The alert sounds 1 short beep and  (EyeSight warning indicator: Yellow) blinks or illuminates. At the same time, the Pre-Collision Braking System OFF indicator light and the Lane Departure Warning OFF indicator light will illuminate. A message will also be displayed on the combination meter display.

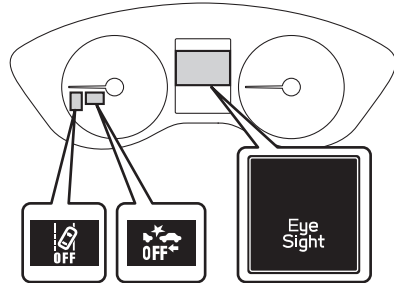



H00027

Displayed screen	Cause	Action
 EyeSight Off Check Manual S03005	An EyeSight malfunction or position/angle misalignment of the stereo camera has occurred.	Inspection and adjustment is necessary. Contact a SUBARU dealer.



NOTE

- If  (EyeSight warning indicator: Yellow) is illuminating or blinking, stop the vehicle in a safe location, turn off the hybrid system and then restart it.
- If  (EyeSight warning indicator: Yellow) continues illuminating or blinking even after the hybrid system has been restarted, the EyeSight system has a malfunction. In this case, all EyeSight functions will be stopped. Normal driving will still be possible. However, contact a SUBARU dealer for an inspection.
- If  (EyeSight warning indicator: Yellow) illuminates or blinks, the Reverse Automatic Braking (RAB) system will not operate.



Temporary stop

The alert will sound 1 short beep, and  (EyeSight temporary stop indicator: White), the Pre-Collision Braking System OFF indicator light and the Lane Departure Warning OFF indicator light will illuminate at the same time. A message will also be displayed on the combination meter display.

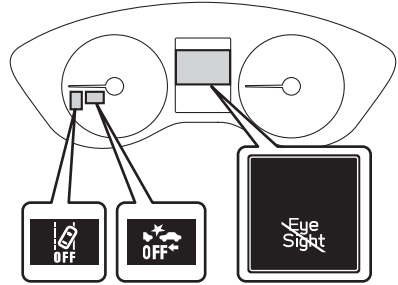
When the cause has been resolved, temporary stop will be canceled and the EyeSight system will automatically restart.





H00028

Displayed screen	Cause	Action
 <p>EyeSight Disabled No Camera View S02996</p>	<p>It is difficult for the stereo camera to detect objects in front.</p> <ul style="list-style-type: none"> • The windshield is dirty or fogged up. • Poor weather conditions • Strong light from the front 	<ul style="list-style-type: none"> • Clean the windshield. • In poor weather conditions or if there is strong light from the front, the EyeSight system will restart once you have driven your vehicle for a period of time and the conditions affecting the system have improved. <p>If the system does not restart, even after the conditions have improved and a period of time has elapsed, contact a SUBARU dealer for an inspection.</p>
 <p>EyeSight Disabled Temp Range S02997</p>	<p>In low or high temperatures</p>	<p>The system will restart once the temperature is within the operational range of the EyeSight system.</p> <p>If the system does not restart, even when the temperature inside the vehicle is within the operational range, contact a SUBARU dealer for an inspection.</p>

Displayed screen	Cause	Action
<div style="background-color: black; color: white; padding: 5px; text-align: center;"> EyeSight Disabled Check Manual </div> <p style="text-align: right; margin-top: 5px;">S02998</p>	<ul style="list-style-type: none"> • The EyeSight system is starting up. • The system has determined that the vehicle is extremely inclined. • The Pre-Collision secondary braking has operated 3 times after the hybrid system was started. • Hybrid READY indicator light turns off. • The electric power steering system is in the overheating prevention status because the steering wheel has been operated while the vehicle is at a standstill or driving at an extremely slow speed. • The EyeSight system judged a different value due to the removal or installation of the steering wheel. • The wheels are out of balance. • The wheels are out of alignment. • The charging cable is connected and the Hybrid READY indicator light illuminates. 	<p>The system will restart once the cause has been resolved. At this time, it may take some time for the system to restart.</p> <p>If the system does not restart, even after the conditions have improved and a period of time has elapsed, contact a SUBARU dealer for an inspection.</p>

 **NOTE**

- When  (EyeSight temporary stop indicator: White) is illuminated, no EyeSight functions can be used except for Conventional Cruise Control.
- When  (EyeSight temporary stop indicator: White) is illuminated, the Reverse Automatic Braking (RAB) system may not operate.

Customizing functions

The following settings can be changed on the combination meter display.

Item		Setting	Default setting
Screen Settings	Driver Assist Indicator	On/Off	On
Warning Volume		Max/Mid/Min	Mid
EyeSight	Lead Vehicle Acquisition Sound	On/Off	On
	Lead Vehicle Moving Monitor Function	On/Off	On
	Cruise Control Acceleration Characteristics	Lv.4 (Dynamic)/ Lv.3 (Standard)/ Lv.2 (Comfort)/ Lv.1 (Eco)	Lv.3 (Standard)



NOTE

These settings can be restored to the factory (default) settings.
⇒ Refer to the vehicle Owner's Manual.

■ How to customize

Operations can be performed when the select lever is in the “P” position and the ignition switch is in the ON position while the vehicle is parked. However, Cruise Control Acceleration Characteristics and warning volume can be changed, even while you are driving.

1. Pull the ▲ / ▼ switch toward you to display the change settings screen.

Pull and hold the ⓘ (Info)/SET switch to change to the settings screen.

2. Pull the ▲ / ▼ switch toward you, select “EyeSight”, “Screen Settings” or “Warning Volume”, and pull the ⓘ (Info)/SET switch to confirm.

The system will then switch to the settings screen.

Operate the following switches according to the display on the screen.

- Select: ▲ (Return) switch/
▼ (Send) switch
- Confirm: ⓘ (Info)/SET switch

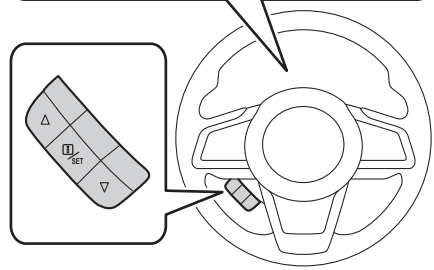
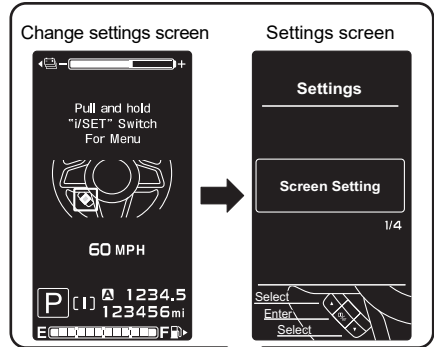

S03872



NOTE

When “Go Back” is selected, the system will return to the screen 1 level above the current one.

● Driver Assist Indicator

The Driver Assist indicator can be activated (On) or deactivated (Off).

● Warning Volume

The volume can be set to Max/Mid/Min.

When on the Warning Volume settings screen, if the volume is selected with the ▲ / ▼ switch, 3 short beeps will sound.

●Lead Vehicle Acquisition Sound

The Lead Vehicle Acquisition Sound setting can be activated (On) or deactivated (Off).

●Lead Vehicle Moving Monitor Function

The Lead Vehicle Start Alert function setting can be activated (On) or deactivated (Off).

●Cruise Control Acceleration Characteristics

The Cruise Control Acceleration Characteristics of the Adaptive Cruise Control and Conventional Cruise Control system can be set to one of four levels.

Lv.4 (Dynamic): Mode used when powerful acceleration is required.

Lv.3 (Standard): Mode that focuses on quick response acceleration.

Lv.2 (Comfort): Mode that focuses on driving with smooth movement.

Lv.1 (Eco): Mode that focuses on driving with smooth movement and optimum fuel economy.

●Canceling the custom functions

In the following cases, the custom functions will be canceled and the change settings screen will be displayed.

- The **i** (Info)/SET switch is pulled and held.
- The hybrid system is turned off.
- The switch is not operated for approximately 30 seconds.

Message screen list



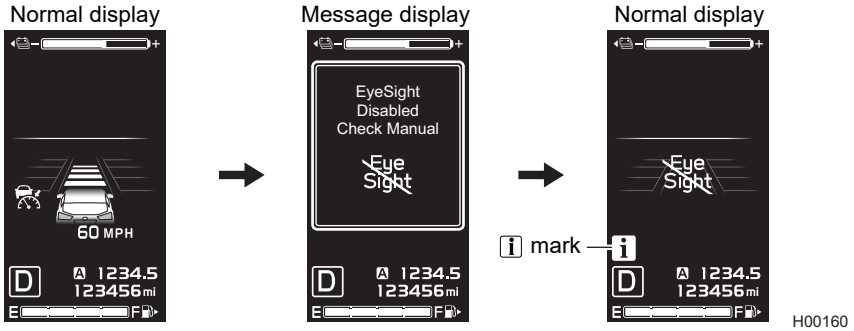

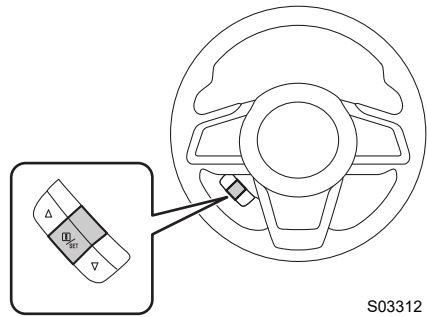

If an EyeSight warning or malfunction is detected, a message will be displayed on the combination meter display. Depending on the message, an alert/notification will sound at the same time.



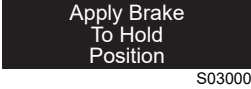

If a message is displayed, refer to the message list and take the appropriate action. While the **i** mark is illuminated, you can pull the **i** (Info)/SET switch to display the message again.

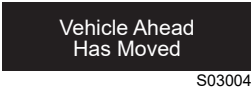
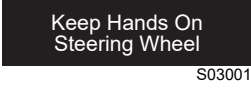





■ Message screen list (precautions and notices)











Item	Displayed screen	 mark	Reference page
Pre-Collision Braking System		None	⇒ Page 37
The “Obstacle Detected” warning	 S02999	None	⇒ Page 67
Pre-Collision Throttle Management		None	⇒ Page 78
Apply Brake	 S03000	None	⇒ Page 37
Lane Departure Warning	 S03002	None	⇒ Page 84
Lane Sway Warning	 S03003	None	⇒ Page 88
Lead Vehicle Start Alert	 S03004	None	⇒ Page 91
Steering operation is not detected by Lane Keep Assist	 S03001	None	⇒ Page 77
Adaptive Cruise Control/Conventional Cruise Control automatic cancellation (when the grade of the road is very steep)	 S03722	None	⇒ Pages 64 and 102











Item	Displayed screen	i mark	Reference page
EyeSight system automatic cancellation	 <p>203196</p>	None	⇒ Page 64
	 <p>S03313</p>	None	⇒ Page 76
	 <p>203198</p>	None	⇒ Page 102



■ Message screen list (malfunction, temporary stop)





Item	Displayed screen	i mark	Reference page
EyeSight system malfunction	 <p>S03005</p>	Yes (yellow)	⇒ Page 108
EyeSight system temporary stop	 <p>S02996</p>	Yes (white)	⇒ Page 109
	 <p>S02997</p>	Yes (white)	
	 <p>S02998</p>	Yes (white)	



Troubleshooting



	<p>Adaptive Cruise Control cannot be activated.</p>
	<p>Did you remember to press the  (CRUISE) switch? If you have not pressed the  (CRUISE) switch,  (Adaptive Cruise Control indicator) will not be shown.</p>
	<p>Is EyeSight operation temporarily stopped? When EyeSight is temporarily stopped,  (EyeSight temporary stop indicator: White) is displayed on the combination meter display. Set Adaptive Cruise Control again after the cause for the temporary stop has been corrected.</p>
	<p>Is READY (READY indicator) displayed? Adaptive Cruise Control cannot be activated when READY (READY indicator) is not displayed. Set Adaptive Cruise Control when READY (READY indicator) is displayed.</p>
	<p>READY (READY indicator) is not displayed.</p>
	<p>Are the requirements for setting cruise control met? For the conditions of READY (READY indicator) illumination, refer to the following pages. ⇒ Page 51 (Adaptive Cruise Control) ⇒ Page 96 (Conventional Cruise Control)</p>



	<p>A vehicle (in front of your vehicle) is not detected, detection is delayed or detection is lost quickly.</p>
	<p>Is the vehicle in front stopped, moving slowly relative to your vehicle or moving extremely slowly? Detection of stopped vehicles, vehicle moving slowly relative to your vehicle, and vehicles moving extremely slowly may be difficult.</p>
	<p>Is the windshield dirty or fogged? If the windshield is dirty or fogged, it may not be possible to detect object or vehicles. Clean off the dirt or fog from the windshield, and then try using the system again.</p>
	<p>Is the vehicle in front far away? The maximum detection distance of the stereo camera is approximately 360 ft (110 m). Detection is not possible if the vehicle is farther away.</p>
	<p>Is the vehicle on a curve? The detection range is limited in the horizontal directions when the stereo camera is properly aimed.</p>
	<p>Is the vehicle on a road with repeated uphill and downhill grades (such as an overpass), or on a banked road? The detection range is limited in the vertical directions.</p>
	<p>Did the vehicle detected in front change? Detection may be delayed after the vehicle in front has changed.</p>
	<p>Have water, snow or other substances been kicked up by the vehicle in front as it drives? When water or snow have been kicked up, it may not be possible to detect the vehicle in front.</p>
	<p>Adaptive Cruise Control is activated even though there is no vehicle in front detected.</p>
	<p>Is there a vehicle in the neighboring lane? Depending on the road conditions, vehicles in neighboring lanes may be detected as well as a vehicle directly in front.</p>
	<p>Are you driving on or near a curve? When driving on a curve, braking control may be activated in response to guardrails, the angle of the steering wheel, or roadside structures.</p>



	<p>Lead Vehicle Start Alert activates, even though there is no vehicle in front.</p>
	<p>Depending on surrounding objects, traffic environment and weather, Lead Vehicle Start Alert may issue a warning in response to objects other than a vehicle that appears in front of your vehicle.</p>



	<p>EyeSight does not restart after a temporary stop.</p>
	<p>Are you driving in the rain with poorly performing wipers or is there a smear on the windshield? Replace the wipers with new ones, or clean the smear off the windshield. Are you driving in poor weather conditions with heavy rain, snow, fog, or dust? In these cases, EyeSight may temporarily stop operating while visibility is very poor.</p>
	<p>Is your vehicle subject to sunlight from the front (sunset or sunrise, etc.) or to bright headlights from oncoming vehicles at nighttime? In these cases, EyeSight may temporarily stop operating.</p>
	<p>Are you parking in an extremely hot or cold condition? In either of these cases, EyeSight may temporarily stop operating until the temperature increases or decreases to a temperature at which the camera is operable.</p>
	<p>Is the charging cable connected? EyeSight cannot be used when the charging cable is connected.</p>









	<p>The timing of the “Obstacle Detected” warning is sometimes earlier or sometimes later than what seems to be normal operation.</p>
	<p>The “Obstacle Detected” warning sounds when the system determines that more braking is necessary, based on conditions such as the distance from the vehicle in front and the difference in speed compared to it. As a result, timing may vary depending on how the brakes are applied in relation to the vehicle in front, and your relative speed to that vehicle.</p>

	<p>When the vehicle in front has turned off the roadway or the distance from the vehicle in front has increased, acceleration is sometimes slower or faster.</p>
	<p>Depending on the timing of when the detection of the vehicle in front is lost, EyeSight's ability to react may be slower, causing the start of acceleration to feel delayed and braking time to feel longer than what seems to be normal operation.</p>
	<p>What acceleration level did you select for cruise control*? Acceleration may vary because the cruise control characteristics vary depending on the selected mode. *: Adaptive Cruise Control and Conventional Cruise Control</p>

	<p>Cruise control is canceled automatically.</p>
	<p>Did you perform one of the following operations? ⇒ Page 64 (Adaptive Cruise Control) ⇒ Page 102 (Conventional Cruise Control)</p>
	<p>Has the EyeSight system temporarily stopped while the Adaptive Cruise Control function was in use?</p>

	<p>A noise occurs when automatic braking control activates.</p>
	<p>This is the sound of the automatic braking control operating - there are some mechanical components to the system, and they do occasionally make audible sounds during automatic braking control. This does not indicate a malfunction.</p>

	<p>Braking control activates frequently when driving with Adaptive Cruise Control in heavy traffic.</p>
	<p>When Adaptive Cruise Control is activated, the EyeSight system performs control based on the movement of vehicles or objects in front. As a result, acceleration and deceleration may be more frequent while the system adjusts to vehicles or objects the camera system is detecting. If it is difficult to maintain a consistent following distance under certain conditions (such as in heavy traffic, poor weather or urban environments, etc.), do not use Adaptive Cruise Control.</p>

	<p>The electronic parking brake is applied automatically while the stay-stopped function is operating.</p>
	<p>The electronic parking brake will be applied in the following cases.</p> <ul style="list-style-type: none"> • The stay-stopped function (⇒ page 62) is continuously applied for approximately 2 minutes. • Automatic cancel conditions (⇒ page 64) have been met.
	<p>Lane Keep Assist was unexpectedly canceled.</p>
	<p>Did you take your hands off the steering wheel? Did you just lightly put your hands on the steering wheel while driving? If the system does not detect the steering operation of the driver, it will temporarily cancel Lane Keep Assist.</p>
	<p>Did you turn a tight corner? Lane Keep Assist does not operate while turning a tight corner.</p>
	<p>Did you perform one of the following operations? ⇒ Page 76</p>
	<p>Lane Keep Assist does not operate even though there are lane markers.</p>
	<p>Is the width of the road too narrow or too wide? To operate Lane Keep Assist, the width of the road should be between approximately 10 ft (3 m) and 15 ft (4.5 m).</p>

MEMO

MEMO

MEMO