

## Foreword

---

This supplement contains explanations and instructions for correctly operating the following systems.

- Navigation System
- Audio and Visual System
- Handsfree System
- APPS

If your vehicle contains one of the systems above, be sure to check the contents of this supplement carefully.

If you transfer the ownership of the vehicle to another person, make sure that this supplement is provided with the Owner's Manual inside the vehicle.

The information, specifications and illustrations in this supplement are valid at the time of publication. SUBARU CORPORATION reserves the right to change the specifications and design without prior notice, with no obligation to perform the same or equivalent changes to vehicles sold in the past.

This Owner's Manual supplement applies to all models, and describes all devices, including manufacturer-installed options. This means that information may be included about devices that are not installed in your vehicle.

Refer to P.14 for details on each of the different models.



SUBARU STARLINK is the "in-car connectivity system" available on select Subaru vehicles.

SUBARU CORPORATION, TOKYO, JAPAN

"SUBARU" and the six-star cluster design are registered trademarks of SUBARU CORPORATION.

©Copyright 2022, SUBARU CORPORATION

## TABLE OF CONTENTS

**1** Quick Guide

**2** Basic Function

**3** Settings

**4** Phone

**5** Apps

**6** Audio

**7** Navigation System (If equipped)

**8** Voice Recognition System

**9** Appendix / What To Do If / Index



· System Types... 14 · Dual 7.0-inch Display System... 15 · 11.6-inch Display System/11.6-inch Display With Navi System... 37

**13**

· Basic Information Before Operation... 64

**63**

· Registering A Bluetooth Phone/Device For The First Time... 74 · Registering A Bluetooth Phone/Device... 78  
· Phone Settings... 77 · General Settings... 83 · Sound Settings... 90 · Radio Settings... 91

**73**

· Calling On The Bluetooth Phone... 100 · Receiving On The Bluetooth Phone... 103  
· Talking On The Bluetooth Phone... 104 · Bluetooth Phone Message Function... 106

**95**

· SUBARU STARLINK... 115 · Apple CarPlay... 121 · Android Auto... 124 · SiriusXM Travel Link... 127

**111**

· Basic Operation... 136 · Radio Operation... 143 · Media Operation... 158 · Audio Remote Controls... 173

**135**

· Map Screen... 186 · Main Menu Screen... 193 · Route Guidance... 203 · Setup... 207  
· SUBARU Map Update... 212

**185**

· Voice Recognition System Operation... 218

**217**

· Troubleshooting... 231 · Index... 242

**225**

**INTRODUCTION****INTRODUCTION**

The symbols described below are found in this instruction manual as well as on the unit itself to ensure its proper and safe usage and to prevent injury or damage to property. Make sure you understand the meaning of these symbols before reading the rest of this manual.

**READ FIRST**

We recommend that you wait until the positioning stabilizes before starting to drive.

If you start to drive while the positioning is not complete, the indicated position may differ from the actual vehicle position.

The screens shown in this manual may differ from the actual screens depending on the data type or when the map data was created.

When maps are created, land surveys are conducted and information on road improvements and reopening is collected to provide the most accurate information possible. However, modifications to roads, place names and facilities may be carried out at any time. Consequently, we cannot guarantee that map data contains no errors in road positions, configuration and names, or in facility names.

Information in this manual that must be observed for the unit, and information that is useful to know is indicated as follows.

### WARNING

- This sign indicates a situation in which incorrect handling through disregard of written information might result in death or serious personal injury.

### CAUTION

- This sign indicates a situation in which incorrect handling through disregard of written information might result in personal injury or damage to property.

### NOTE

- Useful information for the user is described.
- Be sure to read all materials such as manuals and warranties that come with the product. SUBARU CORPORATION is not responsible for problems that arise due to failure to follow these instructions.
- Changes to product specifications may result in differences between the content of the manual and the features of the unit.

## SYMBOLS USED IN ILLUSTRATIONS

### Safety symbol



The symbol of a circle with a slash through it means “Do not”, “Do not do this” or “Do not let this happen”.

### Arrows indicating operations



 Indicates the action (selecting, turning, etc.) used to operate switches and other devices.

## PRECAUTIONS FOR USE

### WARNING

- The main unit requires a 12 V DC power supply. The main unit should not be installed in any vehicle which does not have a 12 V power system with a ground-connected negative side. An installation other than the one intended may cause severe damage to the main unit, and electric shock or serious injury to the users.
- Even when using the route guidance of the navigation system, be sure to drive by following the actual traffic regulations. If you drive by following only the route guidance of the navigation system, you may violate the actual traffic regulations and cause a traffic accident.
- To ensure safety, the driver should not operate the navigation system while driving. Operating the navigation system while driving may result in an accidental steering wheel operation or otherwise cause an accident. Stop the vehicle before operating the navigation system. Also, do not watch the screen while driving because doing so may be dangerous (ETC). Inattention to road conditions ahead may result in an accident.
- The driver should not perform operations such as volume adjustment while driving. Inattention to road conditions ahead may result in an accident, so be sure to stop the vehicle in a safe place before performing the operation.

- The driver should not change discs while driving. Inattention to road conditions ahead may result in an accident, so be sure to stop the vehicle in a safe place before performing the operation.\*
- The driver should not perform operations such as adding a location or setting the memory while driving. Inattention to road conditions ahead may result in an accident, so be sure to stop the vehicle in a safe place before performing the operation.
- Before viewing a video, be sure to stop the vehicle in a safe place and apply the parking brake. To ensure safety, videos are not displayed during driving.
- To ensure safety, never operate a cell phone while driving.
- Do not let foreign objects enter the disc slot. Doing so may result in a fire or electric shock.\*
- Do not disassemble or modify the unit. Doing so may result in an accident, fire or electric shock.
- Do not let water or foreign objects enter the internal parts of the unit. Doing so may result in smoke, fire or an electric shock.
- Do not use the unit when it is malfunctioning, such as when the screen is not lit or no sound comes out. Doing so may result in an accident, fire or electric shock.
- Always replace fuses with fuses of the same specified capacity (amperage). Using a fuse with a higher capacity than the specification may result in a fire.

- If a foreign object or water enters the unit, smoke or a strange odor may be emitted. If such an abnormality occurs, stop using the unit immediately and contact your SUBARU dealer. An accident, fire or electric shock may result if you continue to use the unit under these conditions.
- In a thunderstorm, do not touch the antenna line or the unit. Lightning may cause an electric shock.
- Do not park or stop in prohibited areas to use the unit.
- If direct sunlight shines into the vehicle, light may reflect off the product. Be very careful while driving.
- Never use headphones or earphones while driving. Driving while not being able to hear sounds from outside the vehicle may result in a traffic accident.

\*: If equipped with a CD player

### CAUTION

- Although the unit can be used when the ignition switch is set to either "ACC" or "ON" position, to protect the battery, start the engine before using the unit.
- Do not use the unit anywhere other than in a vehicle. Doing so may result in an electric shock or other injury.
- While driving, keep the volume low enough for you to hear outside sounds. Driving while not being able to hear sounds from outside the vehicle may result in an accident.
- Be careful of the volume when turning on the power. If a loud noise is emitted suddenly when you turn on the power, it may damage your hearing.
- Do not apply a strong force to the display. Doing so may result in a malfunction.

- Do not put your fingers or hands into the disc slot. Doing so may result in an injury.\*
- Do not touch the hot parts of the unit. The hot parts may burn you.
- Do not use while there is an abnormality such as sound breakup or distortion. Doing so may result in a fire.
- Using the unit during extremely high or low temperature may result in mistaken operation or a malfunction. In particular, the temperature inside the vehicle can often rise to a high level during the summer. Cool the vehicle, for example by opening a window, before using the unit.
- Be careful if metal or water enters the unit, or the unit is exposed to a strong impact, because it may result in a malfunction.
- The touch buttons on the display screen may not operate correctly if condensation forms inside them. If this happens, do not attempt to operate the switches until the condensation has disappeared.
- If juice or similar liquid is spilled on the display, wipe off immediately. Failure to do so may result in product malfunction.
- The screen is easily marked by fingerprints and tends to attract dust, and should therefore be cleaned occasionally. When cleaning, turn off the power, and wipe lightly with a soft, dry cloth. To remove dirt, soak a soft cloth in neutral detergent and squeeze well before wiping. Do not use a wet floor-cloth, organic solvents (benzene, ethanol, thinner, etc.), acids, or alkalis. Using such agents will result in screen deterioration. Furthermore, do not hit the screen or rub it with hard objects.

\*: If equipped with a CD player

## NOTE

- SUBARU CORPORATION is not responsible for any damages to the purchaser or third parties that occur from using the map data.
- We do not provide any replacements or refunds for any mistakes there may be in the map data displays or contents, such as misspelling, omissions or misaligned positions.
- SUBARU CORPORATION makes no guarantee that the functions included in the map data will be appropriate for the specific objectives of the purchaser.
- Functions that cannot be operated while driving have their colors toned down when the vehicle is being driven, and their operation is disabled. Touching a disabled switch may result in the display of an operation prohibited message on the screen.
- During strong vibrations, such as when driving on a poor road surface, the unit may no longer be able to read the data from the disc, and it will not operate correctly. When the vibration lessens, normal operation will return after a short time.\*
- Immediately after turning on the heater when the temperature is low, dew (water drops) may adhere to the lens of the CD reader (condensation). If this happens, leaving the unit for about an hour should remove the condensation and return the unit to normal operation.\*  
If the unit does not return to normal operation even after several hours, contact your SUBARU dealer.
- When using the unit for the first time after purchase, or after the battery was removed for a long time, the current position may not be displayed correctly. Wait a short time until the GPS positioning corrects the displayed position.

## NOTE

- This device is precision-engineered equipment and the recorded data can be lost as a result of static electricity, electrical noise, vibration, or other influences. To protect the device against data loss, we recommend keeping a separate record of the data that you record after purchase.
- The screen may be adversely affected or disturbed by noise if electrical equipment that generates powerful electrical noise is used near the system. In such cases, keep the electrical equipment at a distance, or refrain from use.
- The display may appear brighter when the temperature is low, or immediately after starting the engine, however, this is a characteristic of the LED elements, and does not indicate a fault. The display will return to its original brightness when the vehicle cabin has warmed up.
- When you look at the screen through polarized material such as polarized sunglasses, the screen may be dark and hard to see. If so, look at the screen from different angles, adjust the screen settings on the general settings screen or take off your sunglasses.
- It may be difficult to view the screen if the display is exposed to sunlight from an awkward angle.
- The LCD screen may not function normally if covered with a protective film. Do not affix a protective film.
- The touch panel may function incorrectly or fail to respond if operated with objects other than fingers (nails, operation when wearing gloves, pens, etc.)

**NOTE**

- If the system functions unexpectedly such as an area other than the one touched being selected, or failure to respond when touched, there is a possibility that another finger or part of the hand is in contact with display.
- Scratches on the system panel surface are easily noticeable, and it should therefore be handled with care.

\*: If equipped with a CD player

**SAFETY INSTRUCTION (11.6-inch display system/Dual 7.0-inch display system only)**

To use this system in the safest possible manner, follow all the safety tips shown below.

Do not use any feature of this system to the extent it becomes a distraction and prevents safe driving. The first priority while driving should always be the safe operation of the vehicle. While driving, be sure to observe all traffic regulations.

Prior to the actual use of this system, learn how to use it and become thoroughly familiar with it. Read the entire manual to make sure you understand the system. Do not allow other people to use this system until they have read and understood the instructions in this manual.

For your safety, some functions may become inoperable when driving. Unavailable screen buttons are dimmed.

**! WARNING**

- For safety, the driver should not operate the system while he/she is driving. Insufficient attention to the road and traffic may cause an accident.

## SAFETY INSTRUCTION (11.6-inch display with Navi system only)



To use this system in the safest possible manner, follow all the safety tips shown below.

This system is intended to assist in reaching the destination and, if used properly, can do so. The driver is solely responsible for the safe operation of your vehicle and the safety of your passengers.

Do not use any feature of this system to the extent it becomes a distraction and prevents safe driving. The first priority while driving should always be the safe operation of the vehicle. While driving, be sure to observe all traffic regulations.

Prior to the actual use of this system, learn how to use it and become thoroughly familiar with it. Read the entire manual to make sure you understand the system. Do not allow other people to use this system until they have read and understood the instructions in this manual.

For your safety, some functions may become inoperable when driving. Unavailable screen buttons are dimmed. Only when the vehicle is not moving, can the destination and route selection be done.

### **! WARNING**

- For safety, the driver should not operate the system while he/she is driving. Insufficient attention to the road and traffic may cause an accident.
- While driving, be sure to obey the traffic regulations and maintain awareness of the road conditions. If a traffic sign on the road has been changed, route guidance may not have the updated information such as the direction of a one way street.



While driving, listen to the voice instructions as much as possible and glance at the screen briefly and only when it is safe. However, do not totally rely on voice guidance. Use it just for reference. If the system cannot determine the current position correctly, there is a possibility of incorrect, late, or non-voice guidance.

The data in the system may occasionally be incomplete. Road conditions, including driving restrictions (no left turns, street closures, etc.) frequently change. Therefore, before following any instructions from the system, look to see whether the instruction can be done safely and legally.

This system cannot warn about such things as the safety of an area, condition of streets, and availability of emergency services. If unsure about the safety of an area, do not drive into it. Under no circumstances is this system a substitute for the driver's personal judgment.

Use this system only in locations where it is legal to do so. Some states/provinces may have laws prohibiting the use of video and navigation screens next to the driver.

## HOW TO READ THIS MANUAL

Bluetooth® SETTINGS

### REGISTERING A Bluetooth PHONE/DEVICE

- 1 Up to 5 Bluetooth phones/devices can be registered.  
Bluetooth compatible phones (HFP) and devices (AVP) can be registered simultaneously.  
This operation cannot be performed while driving.
- 2
  1. Display the phone settings screen. (→P.77)
  2. Select **Manage Devices** (Manage Devices).
  3. → **Add** (Add)
- 3
  - If a message appears, follow the guidance on the screen.

4. When this screen is displayed, search for the device name displayed on this screen on the screen of your Bluetooth phone/device.



- **Cancel** (Cancel): Select to cancel the registration.
  - For details on operating the Bluetooth phone/device, see the manual that comes with it.
5. Register using your Bluetooth phone/device.
    - A PIN-code is not required for SSP (Secure Simple Pairing) compatible Bluetooth phones/devices. Depending on the type of Bluetooth phone/device being connected, a message confirming registration may be displayed on the Bluetooth phone's/device's screen. Respond and operate the Bluetooth phone/device according to the confirmation message.

No.	Name	Description
1	Operational Outlines	An outline of the operation is explained.
2	Main Operations	The steps of an operation are explained.
3	Supplemental information	Describes supplemental information relating to main operation.

- When a panel button should be selected, button names are shown as **○○○**.
- When a touch button on the screen should be selected, button names are shown as **○○○**.

# 1

## Quick Guide



<b>System Types</b>	14
<b>Dual 7.0-inch Display System</b>	
<b>Function Overview</b>	15
<b>Main Product Features</b>	16
<b>Basic Function</b>	18
Button Overview	18
Home Screen	19
Car Information/Climate Control Screen	20
Pairing The System	
With A Bluetooth Phone/Device	21
Adding A Bluetooth Phone/Device	22
Create A Driver Profile	23
Phone Screen	24
Apps Screen	27

<b>Radio Screen</b>	30
Useful SiriusXM® Radio Functions	31
<b>Media Screen</b>	32
Loading And Unloading A Disc	33
Connecting A USB Memory Device/ Portable Device	33
<b>Settings Screen</b>	34
<b>Steering Wheel Controls</b>	36
Steering Wheel Controls	36
<b>11.6-inch Display System/ 11.6-inch Display With Navi System</b>	
<b>Function Overview</b>	37
<b>Main Product Features</b>	38
<b>Basic Function</b>	40

<b>Overview</b>	40
<b>Home Screen</b>	41
<b>Pairing The System</b>	
<b>With A Bluetooth Phone/Device</b>	42
<b>Adding A Bluetooth Phone/Device</b>	43
<b>Create A Driver Profile</b>	44
<b>Car Information Screen</b>	45
<b>Phone Screen</b>	46
<b>Map Screen</b>	50
<b>Radio Screen</b>	52
Useful SiriusXM® Radio Functions	53
<b>Media Screen</b>	54
Loading And Unloading A Disc	55
Connecting A USB Memory Device/ Portable Device	55
<b>Apps Screen</b>	56
<b>Settings Screen</b>	59
<b>Steering Wheel Controls</b>	61
Steering Wheel Controls	61

## SYSTEM TYPES

This Owner's Manual describes the following three types of system.

### Dual 7.0-inch display system

Two 7.0-inch touch screen  
Display audio system

P.15

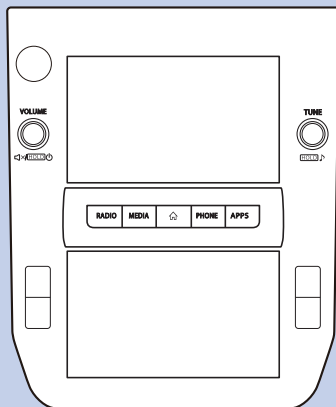

### 11.6-inch display system

11.6-inch touch screen  
Display audio system

P.37

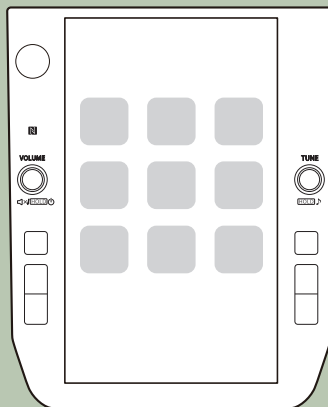

### 11.6-inch display with Navi system

11.6-inch touch screen  
Display audio with  
Navigation system

P.37

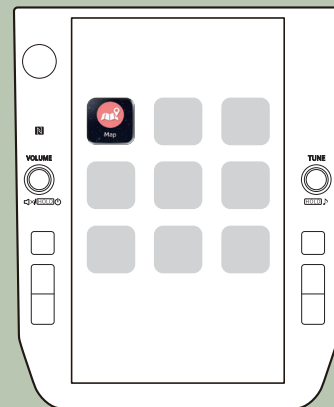

## FUNCTION OVERVIEW

## FUNCTION OVERVIEW

Features: - **Two 7.0-inch touch screens**

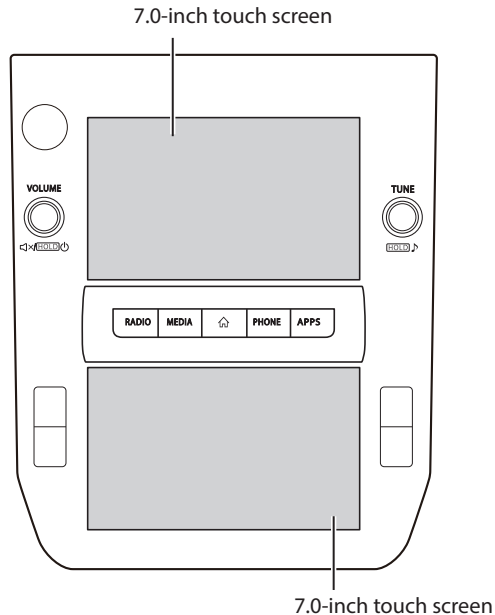

## » MAIN FUNCTIONS

Pairing (Bluetooth 4.2)	P.21
Apps	P.27
Apple CarPlay	P.121
Android Auto	P.124
AM/FM radio	P.30
HD Radio receiver	P.145
SiriusXM® radio	P.31
Media operation	CD*: P.158 USB: P.160 iPod/iPhone: P.162 Bluetooth audio: P.165 AUX: P.168
Phone	P.24
Voice recognition system	P.218
Steering wheel controls	P.36
Rear view camera	Refer to the vehicle Owner's Manual.
Car settings/informations	
Climate controls	

\*: If equipped with a CD player

## MAIN PRODUCT FEATURES

### Adoption of intuitive and easy-to-use smartphone-like graphical user interface



#### Meter cluster linked display

Two 7.0-inch touch screen displays have been adopted. Information can be displayed seamlessly between these displays and the display in the meter cluster.

#### Function description display function

Function descriptions or operation hints can be displayed when an  icon displayed next to the name of a function.

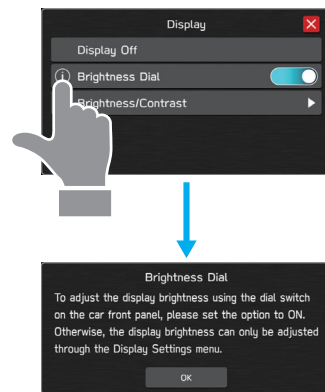

## Customized home screen layout P.72

Frequently used functions and operations can be added to the home screen.



Example: For calling specific phone numbers, listening to specific radio stations, etc.



**The position of screen buttons can be changed by selecting and holding it, then dragging it to the desired position.**

## Apple CarPlay / Android Auto

Support for Apple CarPlay and Android Auto allows access to functions such as maps, phone calls, and music.

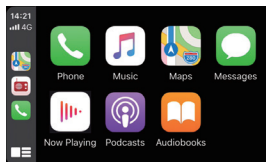

P.121

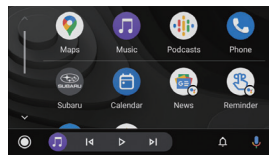

P.124

## System and Bluetooth phone / device pairing P.21

Functions such as hands-free and applications can be used by connecting the system with Bluetooth phones / devices wirelessly.





## BASIC FUNCTION

### BUTTON OVERVIEW

#### TOUCH SCREEN



Operations are performed by touching the touch screen directly with your finger. P.66



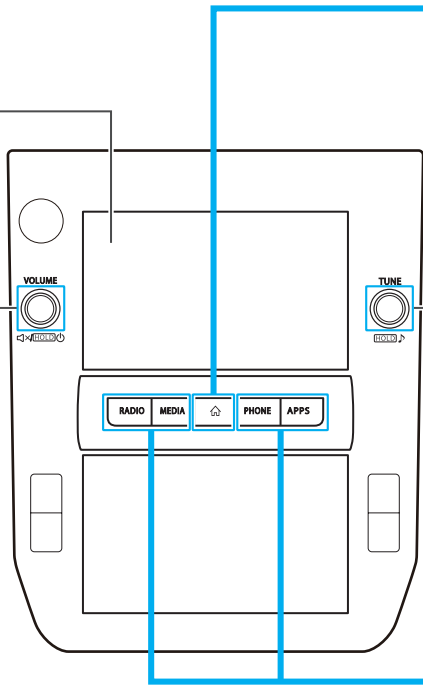

-  **Turn the knob** to adjust the volume.
-  **Press the knob** to turn the volume mute on/off.
-  **Press and hold the knob** until a message is displayed, and then select **OK** (OK) or wait a few seconds for the audio system to turn off. Press and hold the knob to turn the audio system on.
- Press and hold the knob** for 10 seconds or longer to reset the system if the touch screens become unresponsive during operation or if any other system error occurs.



Display the home screen.

-  **Turn the knob** to select a radio station or skip to the next or previous track/file.
-  **Press and hold the knob** to display the sound customization screen. P.138

Shortcut to each screen

	<b>Radio</b>	P.30
	<b>Media</b>	P.32
	<b>Phone</b>	P.24
	<b>Apps</b>	P.27



## HOME SCREEN

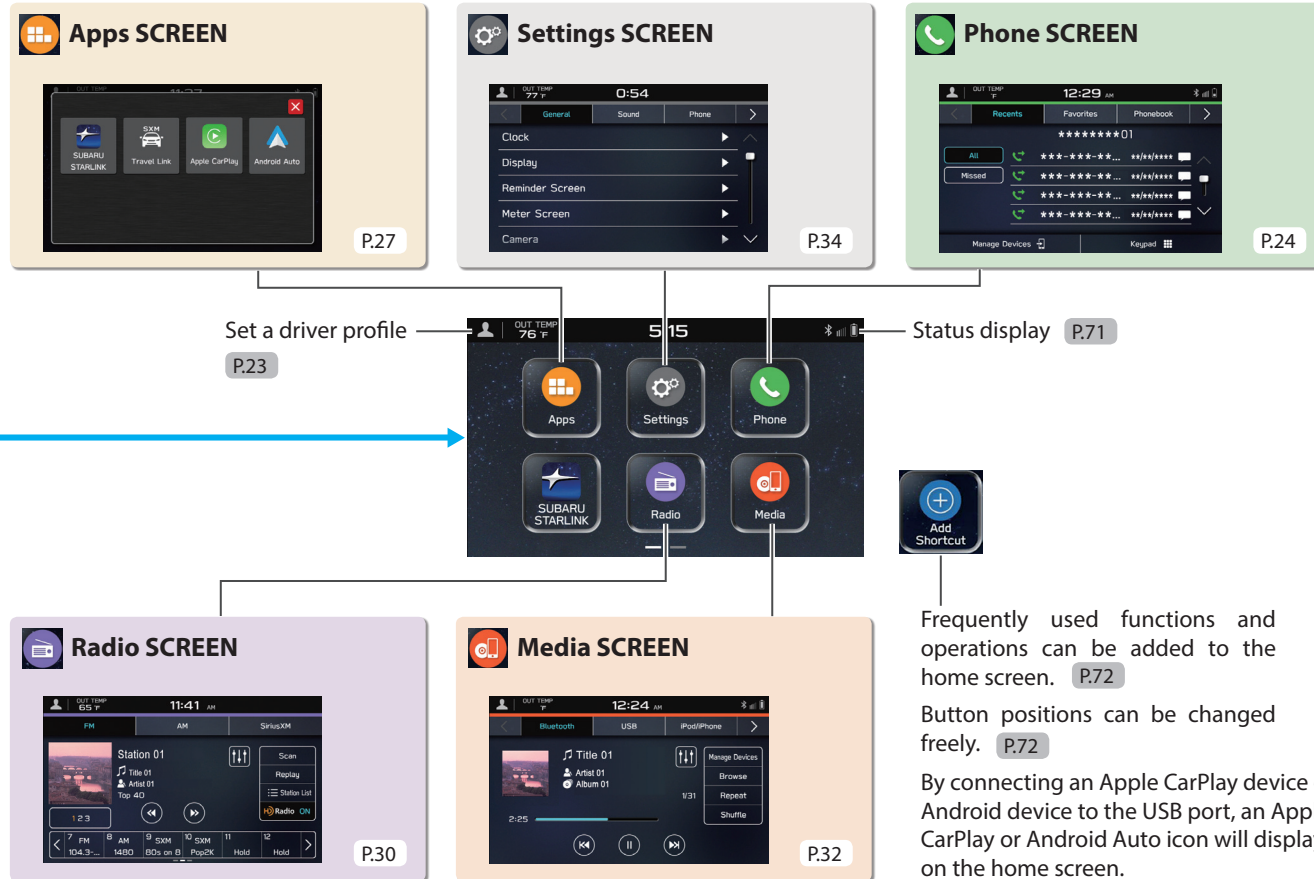

## CAR INFORMATION/CLIMATE CONTROL SCREEN

The settings of driving related functions etc. can be changed.  
Refer to the vehicle Owner's Manual.

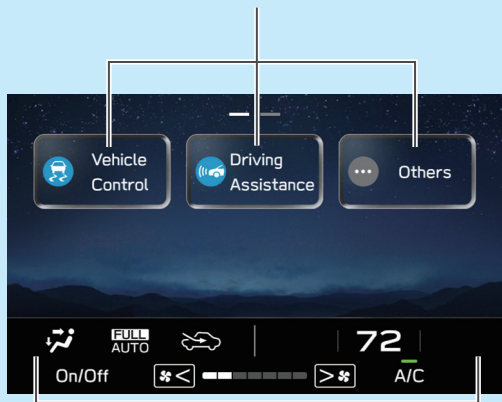

Displays the operating status of climate control.  
Refer to the vehicle Owner's Manual.

The settings of various vehicle related functions can be changed.  
For settings related to EyeSight, refer to the Owner's Manual supplement for the EyeSight system. For all other functions and settings, refer to the vehicle Owner's Manual.

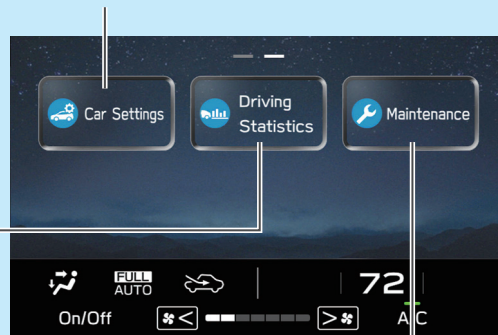

Setup and display vehicle part replacement intervals.  
Refer to the vehicle Owner's Manual.

Displays the operating status of vehicle functions, vehicle status, and vehicle inclination.  
Refer to the vehicle Owner's Manual.

## PAIRING THE SYSTEM WITH A Bluetooth PHONE/DEVICE

### » Display the phone screen.

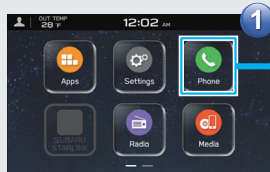

Prepare the Bluetooth phone/ device to be paired.



### » Operate the Bluetooth phone/device.

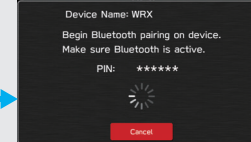
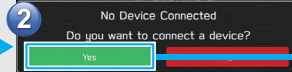

Turn the Bluetooth function of the Bluetooth phone/device ON and select the vehicle's device name.

### » Register the Bluetooth phone/device.

If a confirmation message appears asking whether to transfer the phone's contact data to the system, select the appropriate button.

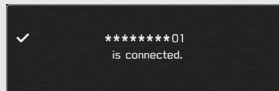

If unable to pair, check whether your Bluetooth phone/device is compatible with the system.

# ADDING A Bluetooth PHONE/DEVICE

Adding from the phone screen

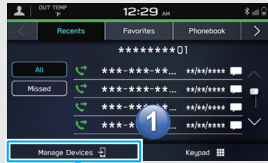

Adding from the Bluetooth audio screen



Adding from the settings screen

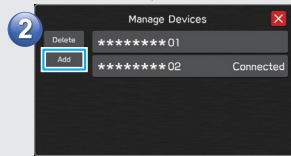

# CREATE A DRIVER PROFILE

1

Quick Guide (DUAL 7.0-INCH DISPLAY SYSTEM)

## » Add a new profile.

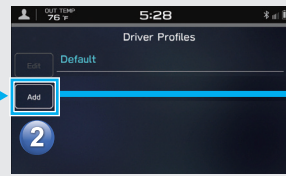

## » Select a language.

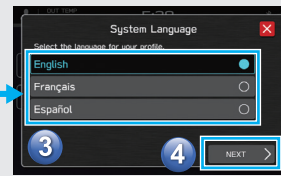

Enter a name.

## » Registering a Bluetooth phone

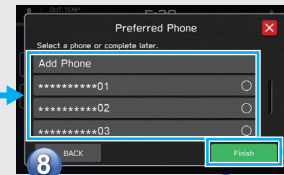

Procedure complete.

## Phone SCREEN

Call or send a text message\* to a recent contact P.101,109

Call or send a text message\* to a registered favorite P.102,109

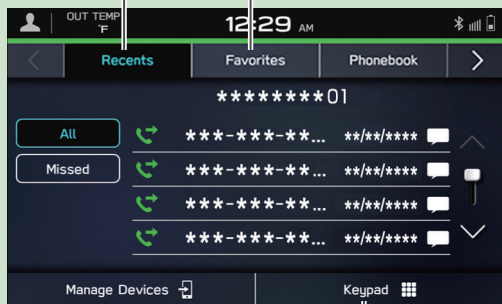

Call or send a text message\* to a contact in the phonebook on the Bluetooth connected phone P.103,109

Check or reply\* to messages/place calls from received message list P.108,109,110

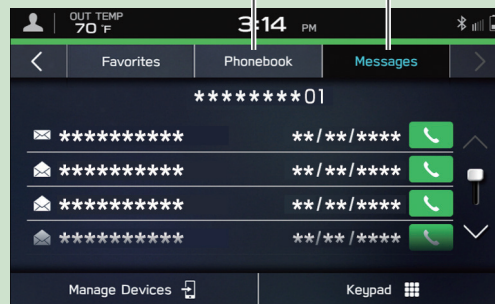

Directly input a number to place a call P.102

\*: If available (for iOS only reception possible)

## - Operation Flow: Receiving Calls and Using the Bluetooth Phone -

» Incoming call screen is displayed.

» In-call screen is displayed.

In-call screen display and operation may differ, or may not be possible depending on the Bluetooth phone used.

## - Operation Flow: Placing Calls from the Phonebook -

» Select call recipient from phonebook.

The notification setting on the Bluetooth phone may need to be activated in order to download the phonebook. If the phonebook download setting is off and a phonebook has not been downloaded, a message will be displayed and the phonebook of the connected Bluetooth phone can be downloaded. P.82

» Select number for making call.

Place call

## - Operation Flow: Receiving a Message\* -

» Incoming text screen is displayed.

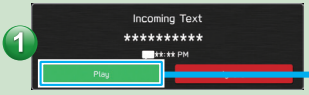

» When there are unread messages in the message inbox

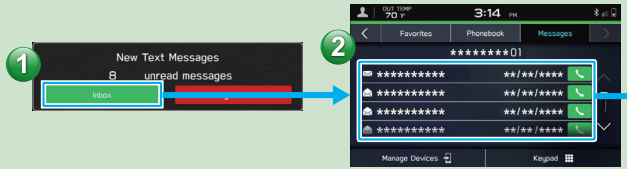

» Message screen is displayed.

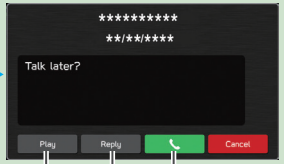

Having messages read out

Calling the message sender

Replying to a message

## - Operation Flow: Sending a Message\* from the Phonebook -

» Select a new contact from phonebook.



The notification setting on the Bluetooth phone may need to be activated in order to download the phonebook. If the phonebook download setting is off and a phonebook has not been downloaded, a message will be displayed and the phonebook of the connected Bluetooth phone can be downloaded. P.82

» Select the message icon next to the desired number.

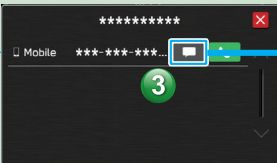

» Select message.

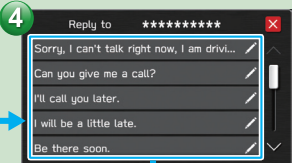

» Send message.

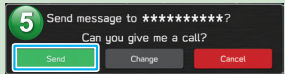



## Apps SCREEN

Usable applications

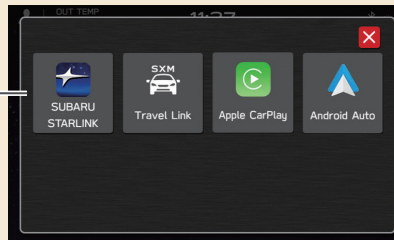

## SUBARU STARLINK

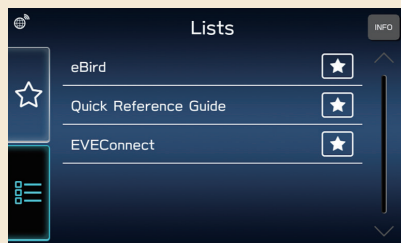

The SUBARU STARLINK app allows users to connect a smartphone to the system, using either Bluetooth or undamaged genuine USB cable (recommended), and access to various music, navigation, vehicle guide applications, and much more.

Download the SUBARU STARLINK app from the Apple App Store or Google Play Store.

To use the SUBARU STARLINK application, connect your iPhone to the USB port or via Bluetooth, or connect your Android device via Bluetooth. P.115



## Apple CarPlay

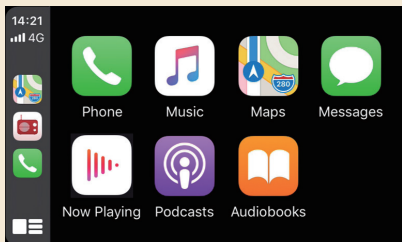

Apple CarPlay can be used to view Apple Maps, play music, and place calls by connecting an Apple CarPlay device to the system. Supported applications can also be run.

To use the Apple CarPlay application, connect an Apple CarPlay device to the USB port with undamaged genuine USB cable. P.121

For details on the services or the operations, check the Apple CarPlay site (<https://www.apple.com/ios/carplay/>).



## Android Auto

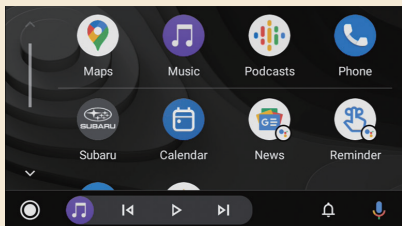

Android Auto can be used to view Google Maps, play music, and place calls by connecting your Android device to the system, using USB cable and Bluetooth. Supported applications can also be run.

To use the Android Auto application, connect your Android device to the USB port with undamaged genuine USB cable. P.124

For details on the services or the operations, check the Android Auto site (<https://www.android.com/auto/>) and (<https://support.google.com/androidauto/>).



## SiriusXM Travel Link

SiriusXM Travel Link is a service provided by SiriusXM® Radio, and can be used to view information on fuel prices, sports, stocks, weather, weather alerts and parking. P.127

To receive the data service information in the vehicle, a subscription to the SiriusXM® Radio Service is necessary following a free trial. P.150



Fuel prices

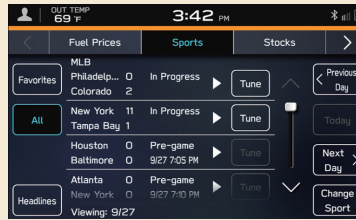

Sports



Stocks



Weather

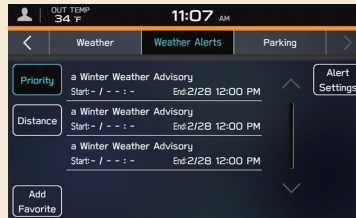

Weather alerts

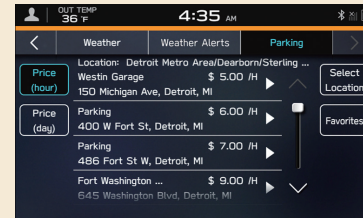

Parking

# Radio SCREEN

Change radio mode



Preset stations/channels

Select to change multicast channels available (FM).

Select to scan for receivable stations/channels.

Select to display a list of receivable stations (AM/FM).

Select to turn HD Radio mode on/off (AM/FM).

## PAUSE AND PLAYBACK LIVE RADIO



Skip backward

Pause/play

Skip forward

Depending on the radio broadcast, the broadcast can be temporarily saved and played back later. P.147,153

## - Operation Flow: Presetting a Radio Station -

» Select the radio band and the radio station.



A valid subscription to SiriusXM® Radio is required to receive satellite radio service.

» Register the radio station.



Select and hold one of the preset buttons.

### Mix preset function

Multiple stations can be registered as presets. (AM, FM or SiriusXM® Radio)

P.144,153

## USEFUL SiriusXM® Radio FUNCTIONS

- Smart Favorites:**  
 The first 10 channels which are registered to a preset button will automatically be registered to Smart Favorites. Channels registered to Smart Favorites can be cached and played back as desired within a certain amount of time. P.93
- Tune Scan:**  
 Channels registered to Smart Favorites can be scanned to find a desired channel. P.149
- Tune Start:**  
 When this function is on, channels registered as Smart Favorites will be cached, and when the channel is changed, the song on that channel can be listened to from the beginning. P.93
- Traffic & Weather Now:**  
 If a city is selected, traffic information and weather news for that city can be heard. P.149
- Favorite Teams:**  
 If you have registered your favorite sports teams, you can be informed of when games start and their progress. P.156
- TuneMix:**  
 If multiple channels for which TuneMix is possible have been registered as TuneMix channels, songs from these channels can be listened to randomly. P.157

## Media SCREEN

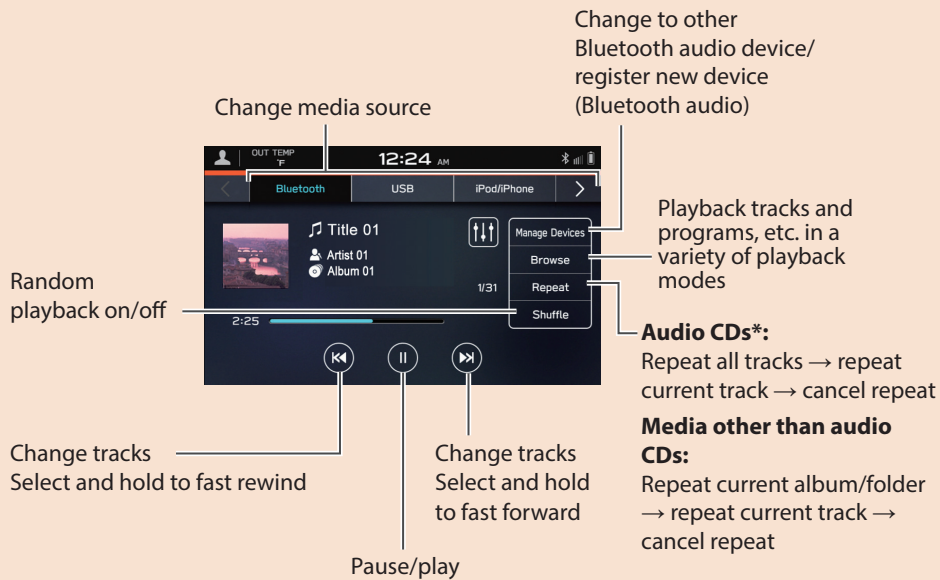

### SUPPORTED MEDIA

CD\* P.177

USB/iPod/iPhone P.180

Bluetooth audio P.75

\*: If equipped with a CD player

## LOADING AND UNLOADING A DISC\*

### » Loading a disc

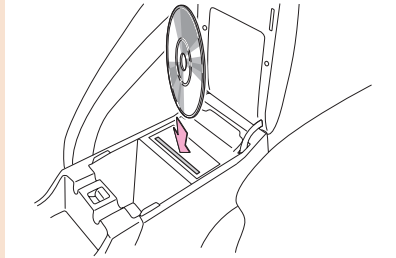

Insert the disc with the label side facing the front of the vehicle.

### » Unloading a disc

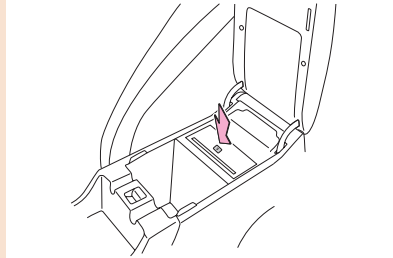

\*: If equipped with a CD player

## CONNECTING A USB MEMORY DEVICE/ PORTABLE DEVICE

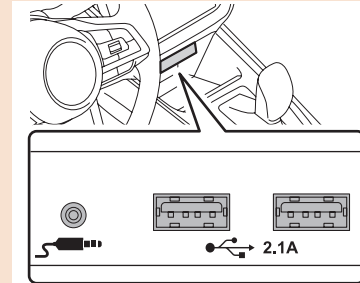

## - Operation Flow: Using Playback Modes -

### » Display the playback mode list.

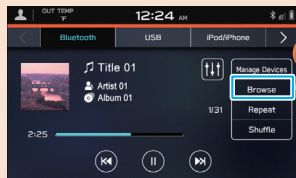

### » Select the playback mode.

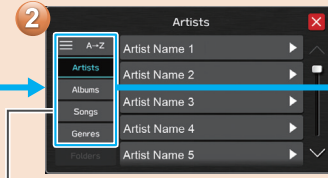

### » Play a track.

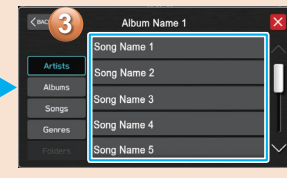

Depending on the audio source, several items from these categories are displayed in a list.

# Settings SCREEN

**General** P.83

- General
- Sound
- Phone

- Clock
- Display
- Reminder Screen
- Meter Screen
- Camera
- Climate Control
- Language: English
- Tire Pressure Units: kPa
- Home Screen Shortcuts
- Welcome Screen
- Goodbye Screen
- Birthday List
- Anniversary List
- SUBARU STARLINK: Apps Recovery
- SUBARU STARLINK: Auto Connect
- Factory Data Reset
- System Information
- Free/Open Source Software Information

SCROLL

**Sound** P.90

- General
- Sound
- Phone

- Audio
- Notification Volume: 19
- Beep Sound Setting:
- Beep Sound Volume: 17
- Phone Ringtone Volume: -1
- Incoming Call Volume: 19
- Call Volume: 0
- SMS/MMS Ringtone Volume: 19
- SMS/MMS Read Out Volume: 17
- Voice Volume: 24

SCROLL

**Phone** P.77

- General
- Sound
- Phone

- Manage Devices
- Phonebook/Recent Calls
- Message
- Change Device Name: WRX
- Apple CarPlay
- Android Auto

SCROLL

**Radio** P.91

- Sound
- Phone
- Radio

- FM
- AM
- SiriusXM



## - Operation Flow: Setting the Clock Manually -

Under normal conditions, when a Bluetooth phone is connected to the system, the clock will be adjusted automatically. If the clock is not adjusted automatically or a Bluetooth phone is not connected, it is necessary to adjust the clock manually.

### » Display the clock settings screen.

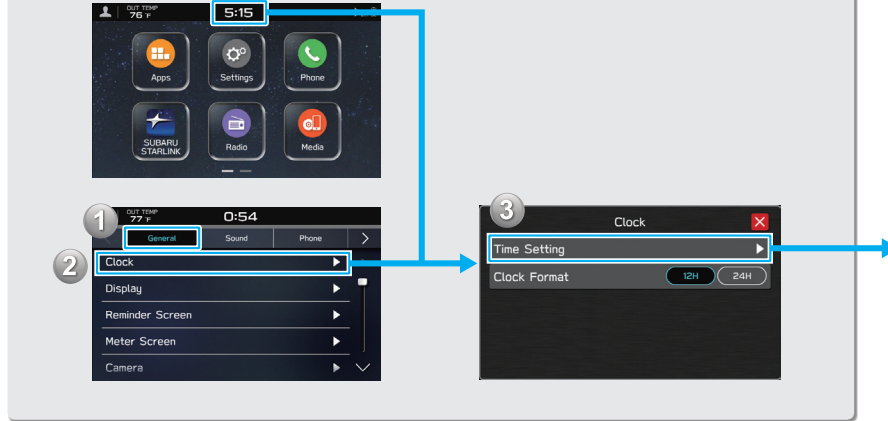

### » Select the manual mode.



### » Adjust the clock.

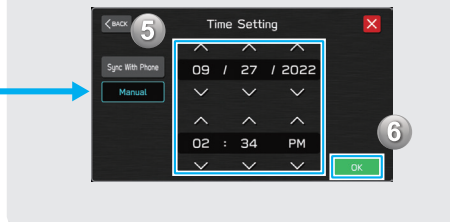

## STEERING WHEEL CONTROLS

### STEERING WHEEL CONTROLS

Some parts of the audio system can be controlled using the steering wheel controls.

P.173

**Press:** Volume up/down

**Press and hold:** Volume up/down continuously

**Press:** Turn on the audio system or change the audio source mode

**Press and hold:** Turn off the audio system

#### RADIO

**Press:** Preset station/channel up/down

**Press and hold:** Scan and stop at the first received station when the switch is released

#### MEDIA

**Press:** Change a track/file

**Press and hold:** Fast forward/rewind

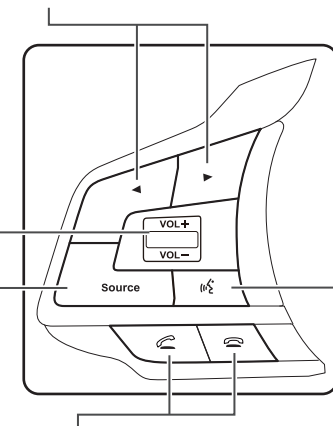

**Press:** Start the voice recognition system  
P.218

**Press and hold:** Start the Apple CarPlay/  
Android Auto voice recognition function

**Press:** Receive/end a call without taking your hands off the steering wheel P.98

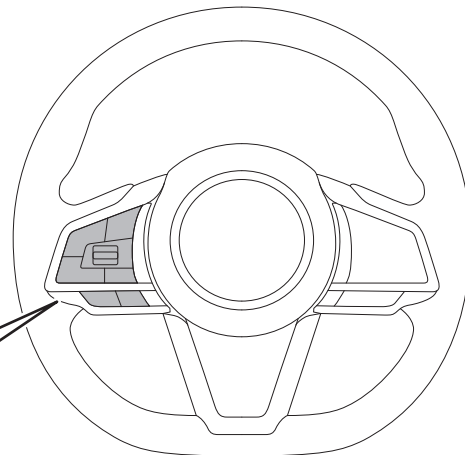

## FUNCTION OVERVIEW

## FUNCTION OVERVIEW

- Features: - **11.6-inch touch screen**  
- **Map (Map) button**\*1\*2

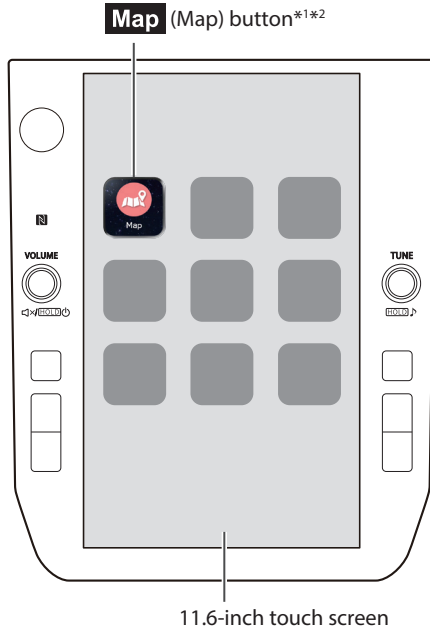

## » MAIN FUNCTIONS

Pairing (Bluetooth 4.2)	P.42
Navigation system*1	P.50
Apps	P.56
Apple CarPlay	P.121
Android Auto	P.124
AM/FM radio	P.52
HD Radio receiver	P.145
SiriusXM® radio	P.53
Media operation	CD*3: P.158 USB: P.160 iPod/iPhone: P.162 Bluetooth audio: P.165 AUX: P.168
Phone	P.46
Voice recognition system	P.218
NFC	P.42
Steering wheel controls	P.61
Rear view camera	Refer to the vehicle Owner's Manual.
Car settings/informations	
Climate controls	

\*1: If equipped

\*2: Displayed position may differ

\*3: If equipped with a CD player

## MAIN PRODUCT FEATURES

### Adoption of intuitive and easy-to-use smartphone-like graphical user interface



#### Meter cluster linked display

A large 11.6-inch touch screen display has been adopted. Information can be displayed seamlessly between this display and the display in the meter cluster.

#### Function description display function

Function descriptions or operation hints can be displayed when an  icon displayed next to the name of a function.

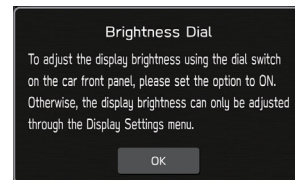
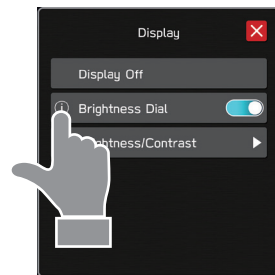

## Expandable map screen\*

The map screen can be expanded to fill more of the display.

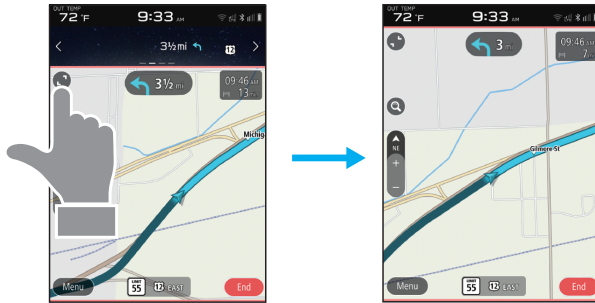

## Rough destination search function\* P.195

Start a search with a variety of words such as addresses, facility names, intersection names, or latitude/longitude.

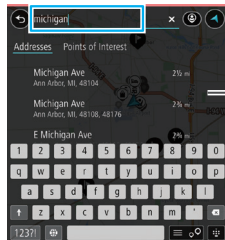

Displays search prediction

- Search results are predicted and candidates displayed even if only partial words are known
- Searches can even be performed with multiple keywords.

\*: If equipped

## Customized home screen layout P.72

Frequently used functions and operations can be added to the home screen.

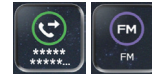

Example: For calling specific phone numbers, listening to specific radio stations, etc.

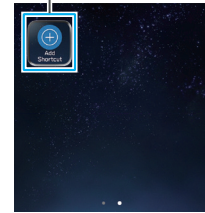

The position of screen buttons can be changed by selecting and holding it, then dragging it to the desired position.

## System and Bluetooth phone / device pairing P.42

Functions such as hands-free and applications can be used by connecting the system with Bluetooth phones / devices wirelessly.



## Apple CarPlay / Android Auto

Support for Apple CarPlay and Android Auto allows access to functions such as maps, phone calls, and music.



P.121

P.124



## BASIC FUNCTION

### OVERVIEW

#### TOUCH SCREEN

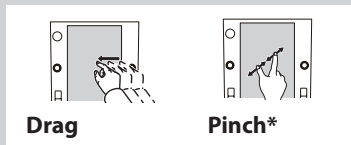
Operations are performed by touching the touch screen directly with your finger. P.66





-  **Turn the knob** to adjust the volume.
-  **Press the knob** to turn the volume mute on/off.
-  **Press and hold the knob** until a message is displayed, and then select **OK** (OK) or wait a few seconds for the audio system to turn off. Press and hold the knob to turn the audio system on.
- Press and hold the knob** for 10 seconds or longer to reset the system if the touch screen becomes unresponsive during operation or if any other system error occurs.

Status display area P.71

Information display area  
Refer to the vehicle Owner's Manual.



-  **Turn the knob** to select a radio station or skip to the next or previous track/file.
-  **Press and hold the knob** to display the sound customization screen. P.138

Display the home screen.

Set a driver profile P.44

Climate control display area  
Refer to the vehicle Owner's Manual.

Display the vehicle settings screen.  
Refer to the vehicle Owner's Manual.

\*: If equipped

## HOME SCREEN

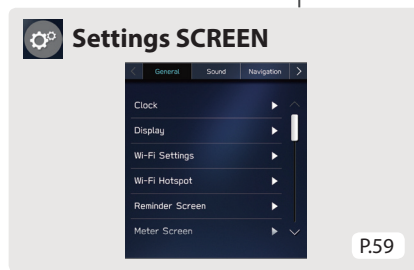
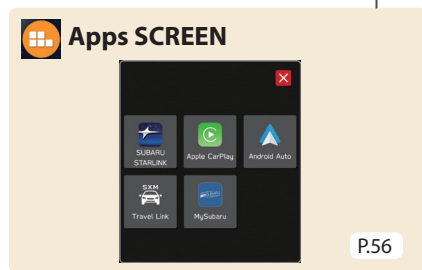
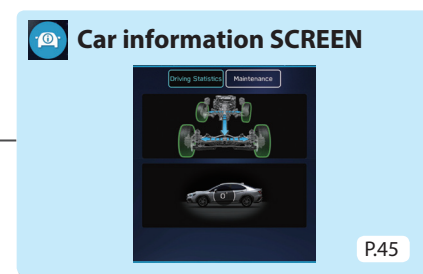
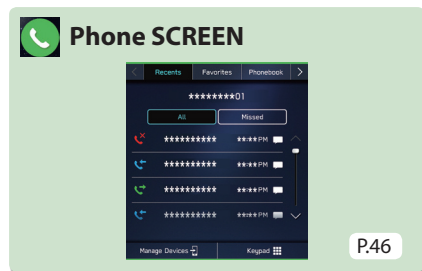
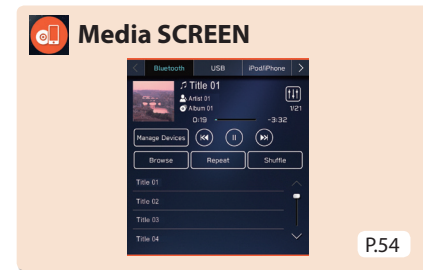
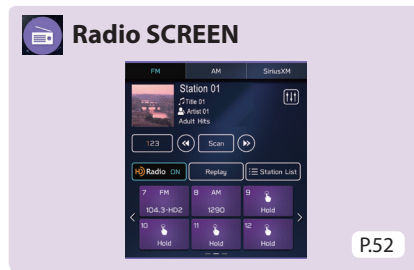
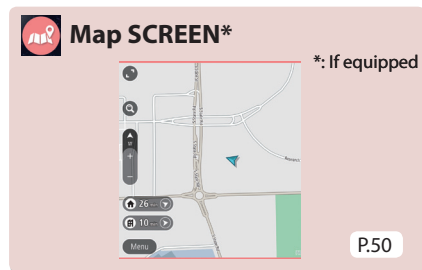

Frequently used functions and operations can be added to the home screen. P.72

Button positions can be changed freely. P.72

By connecting an Apple CarPlay device or Android device to the USB port, an Apple CarPlay or Android Auto icon will display on the home screen.

## PAIRING THE SYSTEM WITH A Bluetooth PHONE/DEVICE

» Display the phone screen.



Prepare the Bluetooth phone/device to be paired.

» Operate the Bluetooth phone/device.

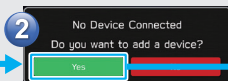

Turn the Bluetooth function of the Bluetooth phone/device ON and select the vehicle's device name.

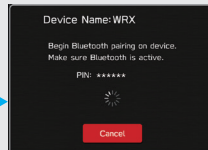

» Register the Bluetooth phone/device.

If a confirmation message appears asking whether to transfer the phone's contact data to the system, select the appropriate button.

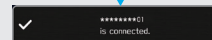

If unable to pair, check whether your Bluetooth phone/device is compatible with the system.

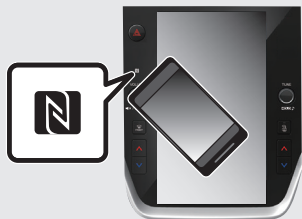

When using an NFC compatible device, it is not necessary to perform the above procedure.

Pairing can be performed by holding the device against the NFC logo of the audio system with the NFC setting on.



# ADDING A Bluetooth PHONE/DEVICE

## Adding from the phone screen

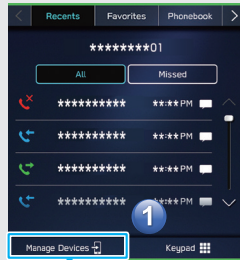

## Adding from the Bluetooth audio screen

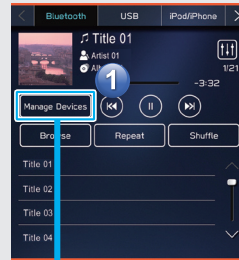

## Adding from the settings screen

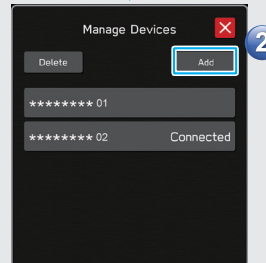

# CREATE A DRIVER PROFILE

## » Add a new profile.

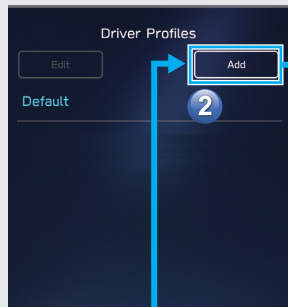
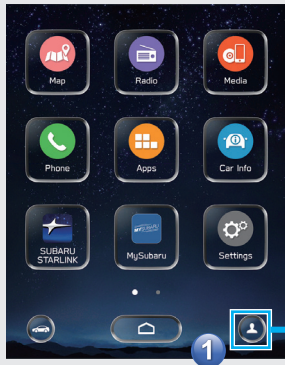

## » Select a language.

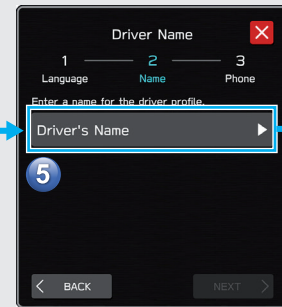
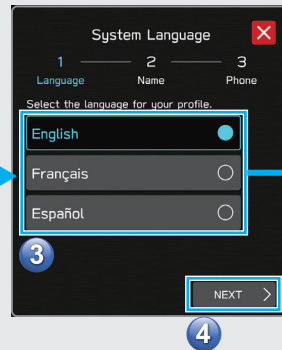

## » Registering a Bluetooth phone



Enter a name.



Driver Profile list has been successfully updated.

Procedure complete.



## Car information SCREEN

Displays the operating status of vehicle functions, vehicle status, and vehicle inclination.

Refer to the vehicle Owner's Manual.

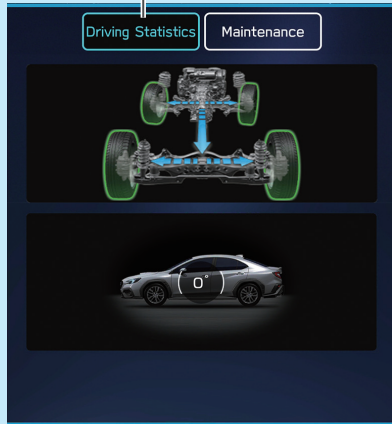

Setup and display vehicle part replacement intervals.

Refer to the vehicle Owner's Manual.

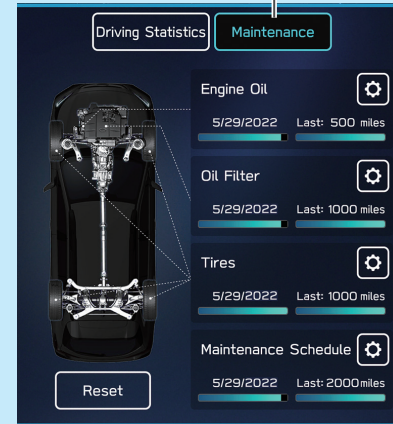



# Phone SCREEN

Call or send a text message\* to a recent contact P.101,109

Call or send a text message\* to a registered favorite P.102,109

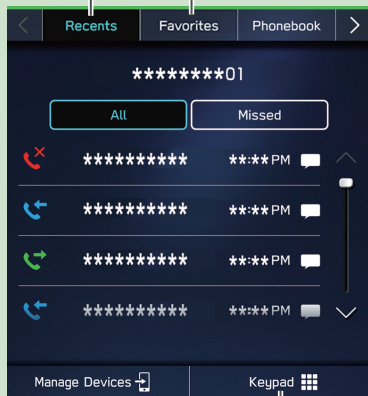

Call or send a text message\* to a contact in the phonebook on the Bluetooth connected phone P.103,109

Check or reply\* to messages/place calls from received message list P.108,109,110

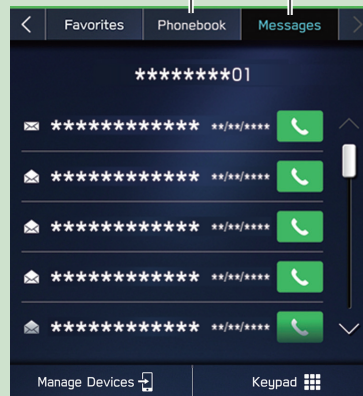

Directly input a number to place a call P.102

\*: If available (for iOS only reception possible)

## - Operation Flow: Receiving Calls and Using the Bluetooth Phone -

» Incoming call screen is displayed.

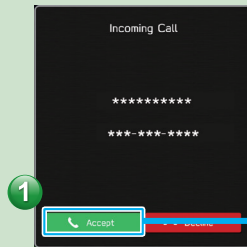

» In-call screen is displayed.

Mute the connected smartphone's voice

Switch to call with other party

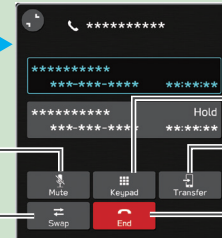

Keypad

Transfer call to Bluetooth phone

End call

In-call screen display and operation may differ, or may not be possible depending on the Bluetooth phone used.

## - Operation Flow: Placing Calls from the Phonebook -

» Select call recipient from phonebook.

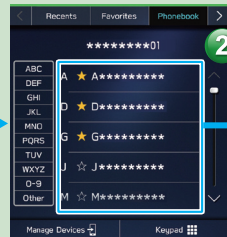
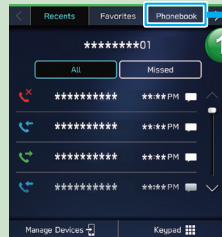

» Select number for making call.

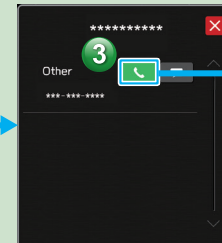

Place call

The notification setting on the Bluetooth phone may need to be activated in order to download the phonebook. If the phonebook download setting is off and a phonebook has not been downloaded, a message will be displayed and the phonebook of the connected Bluetooth phone can be downloaded. P.82

## - Operation Flow: Receiving a Message\* -

» Incoming text screen is displayed.

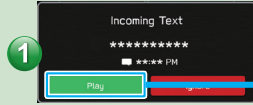

» When there are unread messages in the message inbox



» Message screen is displayed.



Having messages  
read out

Calling the message  
sender

Replying to a message

\*: If available (for iOS only reception possible)

## - Operation Flow: Sending a Message\* from the Phonebook -

» Select a contact from phonebook.



The notification setting on the Bluetooth phone may need to be activated in order to download the phonebook. If the phonebook download setting is off and a phonebook has not been downloaded, a message will be displayed and the phonebook of the connected Bluetooth phone can be downloaded.

P.82

» Select the message icon next to the desired number.

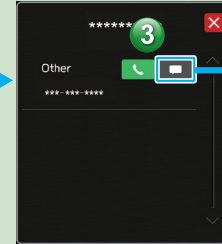

» Select message.

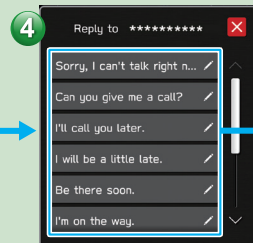

» Send message.

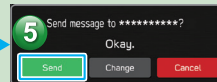

\*: If available (for iOS only reception possible)



## Map SCREEN\*

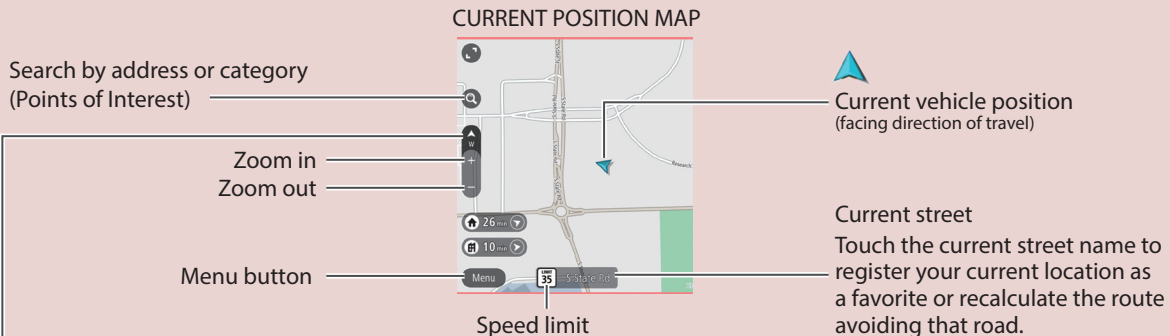

\*: If equipped

The orientation of the map can be changed between 2D north-up, 2D heading-up and 3D heading-up. P.189

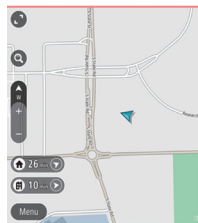

2D North-up screen

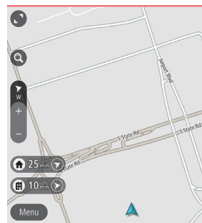

2D Heading-up screen



3D Heading-up screen

## ROUTE GUIDANCE SCREEN

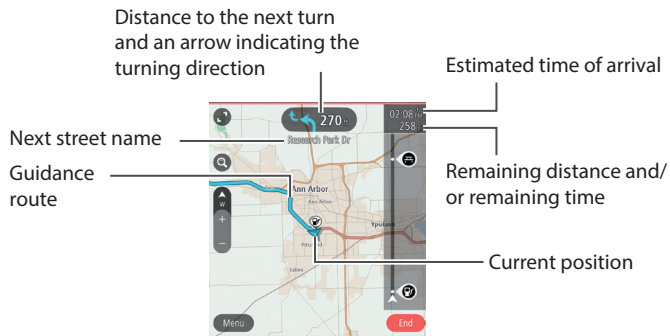

Route guidance P.203



## - Operation Flow: Route Guidance -

### » Display the destination search menu.

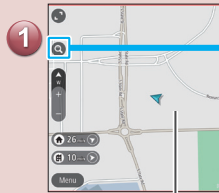

Destinations can also be set directly from the Map screen by selecting and holding at the desired position until **+** is displayed.

### » Search for your destination.

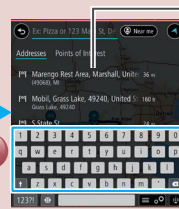

Predicted search results will automatically appear as you type.

Start a search by typing an address or category (Points of Interest).

### » Select your destination.



Destinations matching the search words are displayed in a list.

### » Start driving.

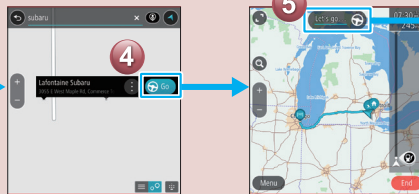

### » Route guidance starts.

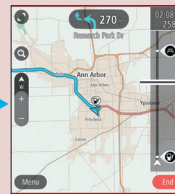

The travel route is displayed, and voice guidance starts.



JUNCTION SCREEN

The screen display automatically changes to display travel lanes at expressway junctions, etc.

P.204

### RETURNING HOME

If you register an address as Home, it can be quickly set as a destination.

Register an address as Home P.200

Setting Home as the destination P.186

# Radio SCREEN

Change radio mode

Select to change multicast channels available (FM).

Change radio mode



Preset stations/channels

Select to turn HD Radio mode on/off (AM/FM).

Select to scan for receivable stations/channels.

Select to display a list of receivable stations (AM/FM).

## PAUSE AND PLAYBACK LIVE RADIO



Skip backward

Pause/play

Skip forward

Depending on the radio broadcast, the broadcast can be temporarily saved and played back later. P.147,153

## - Operation Flow: Presetting a Radio Station -

### » Select the radio band and the radio station.



A valid subscription to SiriusXM® Radio is required to receive satellite radio service.

### » Register the radio station.



Select and hold one of the preset buttons.

### Mix preset function

Multiple stations can be registered as presets. (AM, FM or SiriusXM® Radio)

P.144,153

## USEFUL SiriusXM® Radio FUNCTIONS

- Smart Favorites:**  
 The first 10 channels which are registered to a preset button will automatically be registered to Smart Favorites. Channels registered to Smart Favorites can be cached and played back as desired within a certain amount of time. P.93
- Tune Scan:**  
 Channels registered to Smart Favorites can be scanned to find a desired channel. P.149
- Tune Start:**  
 When this function is on, channels registered as Smart Favorites will be cached, and when the channel is changed, the song on that channel can be listened to from the beginning. P.93
- Traffic & Weather Now:**  
 If a city is selected, traffic information and weather news for that city can be heard. P.149
- Favorite Teams:**  
 If you have registered your favorite sports teams, you can be informed of when games start and their progress. P.156
- TuneMix:**  
 If multiple channels for which TuneMix is possible have been registered as TuneMix channels, songs from these channels can be listened to randomly. P.157

## Media SCREEN

Change to other Bluetooth audio device/  
register new device  
(Bluetooth audio)

Change media source

Playback tracks and  
programs, etc. in a  
variety of playback  
modes

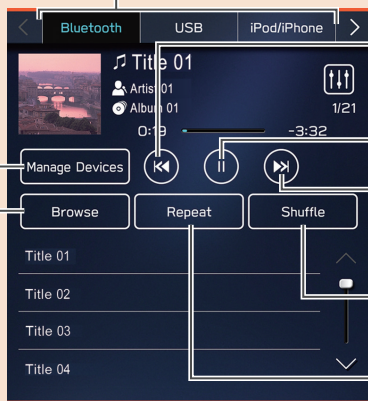

Change tracks  
Select and hold to  
fast rewind

Pause/play

Change tracks  
Select and hold to fast  
forward

Random  
playback on/off

**Audio CDs\*:**  
Repeat all tracks → repeat  
current track → cancel repeat

**Media other than audio  
CDs:**  
Repeat current album/folder  
→ repeat current track →  
cancel repeat

### SUPPORTED MEDIA

CD\* P.177

USB/iPod/iPhone P.180

Bluetooth audio P.75

\*: If equipped with a CD player

## LOADING AND UNLOADING A DISC\*

### » Loading a disc

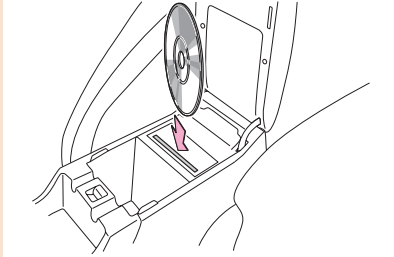

Insert the disc with the label side facing the front of the vehicle.

### » Unloading a disc

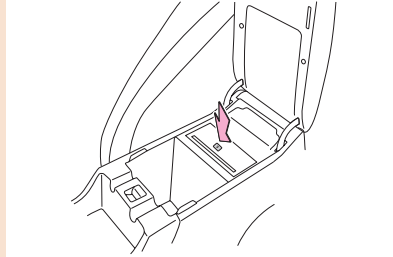

\*: If equipped with a CD player

## CONNECTING A USB MEMORY DEVICE/ PORTABLE DEVICE

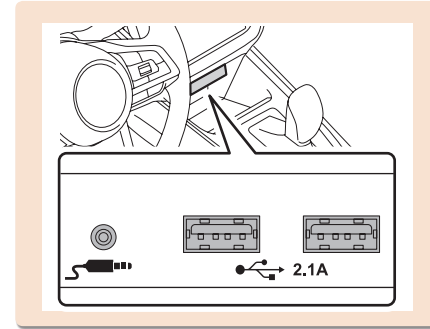

## - Operation Flow: Using Playback Modes -

### » Display the playback mode list.

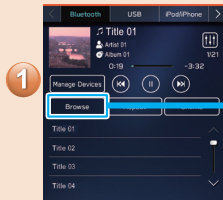

### » Select the playback mode.



### » Play a track.

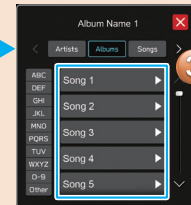

Depending on the audio source, several items from these categories are displayed in a list.

## Apps SCREEN

Usable applications

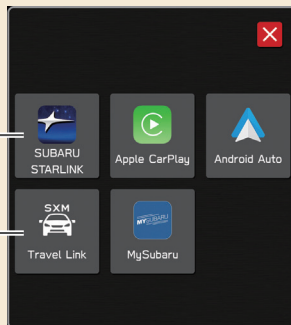

## SUBARU STARLINK

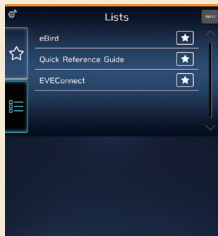

The SUBARU STARLINK app allows users to connect a smartphone to the system, using either Bluetooth or undamaged genuine USB cable (recommended), and access to various music, navigation, vehicle guide applications, and much more.

Download the SUBARU STARLINK app from the Apple App Store or Google Play Store.

To use the SUBARU STARLINK application, connect your iPhone to the USB port or via Bluetooth, or connect your Android device via Bluetooth. P.115



## Apple CarPlay

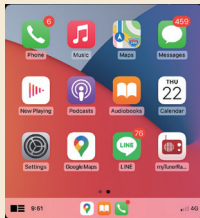

Apple CarPlay can be used to view Apple Maps, play music, and place calls by connecting an Apple CarPlay device to the system. Supported applications can also be run.

To use the Apple CarPlay application, connect an Apple CarPlay device to the USB port with undamaged genuine USB cable. P.121

For details on the services or the operations, check the Apple CarPlay site (<https://www.apple.com/ios/carplay/>).



## Android Auto

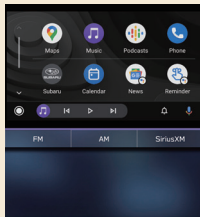

Android Auto can be used to view Google Maps, play music, and place calls by connecting your Android device to the system, using USB cable and Bluetooth. Supported applications can also be run.

To use the Android Auto application, connect your Android device to the USB port with undamaged genuine USB cable. P.124

For details on the services or the operations, check the Android Auto site (<https://www.android.com/auto/>) and (<https://support.google.com/androidauto/>).



## MySubaru

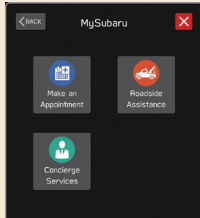

Access SUBARU STARLINK from “SUBARU STARLINK Safety and Security” for a variety of remote services.

Refer to the Owner’s Manual supplement for “SUBARU STARLINK Safety and Security” for details.



# SiriusXM Travel Link

SiriusXM Travel Link is a service provided by SiriusXM® Radio, and can be used to view information on fuel prices, sports, stocks, weather, weather alerts and parking. P.127

To receive the data service information in the vehicle, a subscription to the SiriusXM® Radio Service is necessary following a free trial. P.150

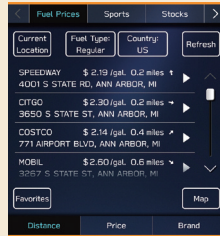

Fuel prices

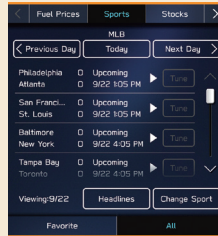

Sports



Stocks



Weather

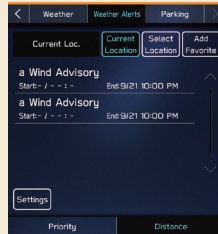

Weather alerts

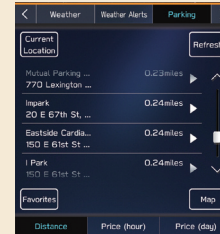

Parking





# Settings SCREEN

## General

P.83

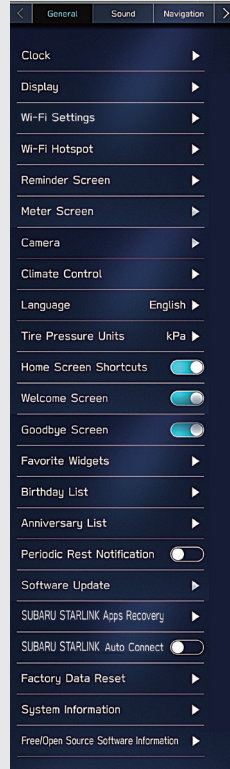

SCROLL

## Sound

P.90

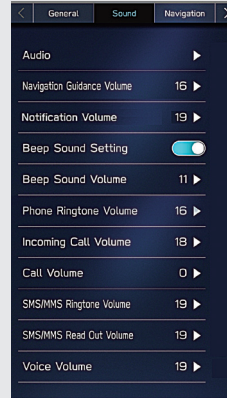

SCROLL

## Phone

P.77



## Navigation

P.207

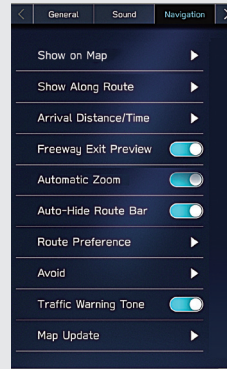

SCROLL

## Radio

P.91

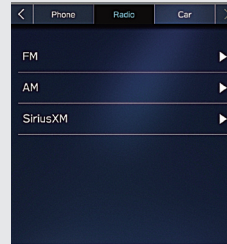

## Car\*

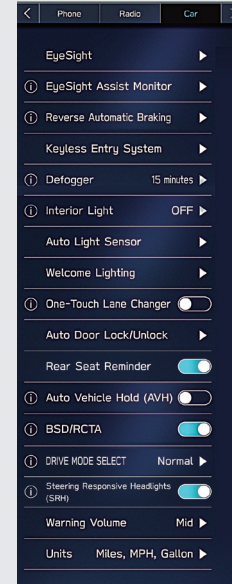

SCROLL

\*: For settings related to EyeSight, refer to the Owner's Manual supplement for the EyeSight system.  
For all other functions and settings, refer to the vehicle Owner's Manual.

## - Operation Flow: Setting the Clock Manually -

Under normal conditions, the clock is adjusted automatically when the system receives GPS signals\*1\*2 or when a Bluetooth phone is connected to the system\*3. If the clock is not adjusted automatically, it is necessary to adjust the clock manually.

### » Display the clock settings screen.



### » Select the manual mode.

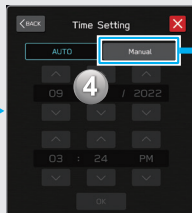

### » Adjust the clock.

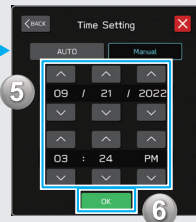

\*1: 11.6-inch display with Navi system  
 \*2: 11.6-inch display system with SUBARU STARLINK Safety and Security  
 \*3: 11.6-inch display system without SUBARU STARLINK Safety and Security

## STEERING WHEEL CONTROLS

## STEERING WHEEL CONTROLS

Some parts of the audio system can be controlled using the steering wheel controls.

P.173

**Press:** Volume up/down

**Press and hold:** Volume up/down continuously

**Press:** Turn on the audio system or change the audio source mode

**Press and hold:** Turn off the audio system

**RADIO**

**Press:** Preset station/channel up/down

**Press and hold:** Scan and stop at the first received station when the switch is released

**MEDIA**

**Press:** Change a track/file

**Press and hold:** Fast forward/rewind

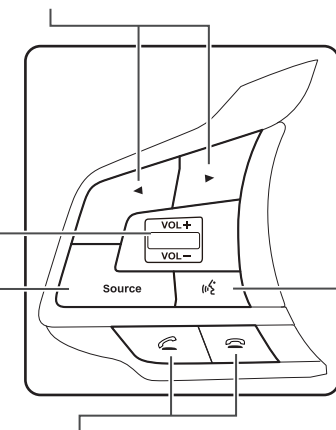

**Press:** Start the voice recognition system  
P.218

**Press and hold:** Start the Apple CarPlay/  
Android Auto voice recognition function

**Press:** Receive/end a call without taking your hands off the steering wheel P.98

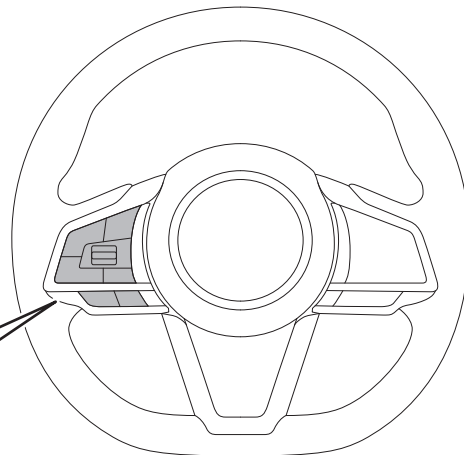



# 2

## Basic Function



<b>Basic Information Before Operation</b>	64
<b>Initial Screen</b>	64
Initial Screen	64
<b>Loading And Unloading A Disc</b>	65
Loading A Disc	65
Unloading A Disc	65
<b>Connecting And Disconnecting A USB Memory Device/Portable Device</b>	66
Connecting A Device	66
<b>Touch Screen Gestures</b>	66
<b>Touch Screen Operation</b>	67

<b>Entering Letters And Numbers/ List Screen Operation</b>	68
Entering Letters And Numbers	68
List Screen Operation	69
<b>Screen Adjustment</b>	70
Adjusting Brightness	70
Changing Between Day And Night Mode	70
<b>Status Display</b>	71
<b>Home Screen Operation</b>	72
Adding Shortcut Icons To The Home Screen	72
Moving And Deleting Shortcut Icons	72

## BASIC INFORMATION BEFORE OPERATION

## INITIAL SCREEN

## INITIAL SCREEN

 **WARNING**

- When the vehicle is stopped with the engine running, always apply the parking brake for safety.

1. When the ignition switch is turned to the “ACC” or “ON” position, the initial screen will be displayed and the system will begin operating.



- After a few seconds, the “CAUTION” screen will be displayed.

2. Select **I Agree** (I Agree).



## LOADING AND UNLOADING A DISC (IF EQUIPPED WITH A CD PLAYER)

### LOADING A DISC

#### CAUTION

- Never try to disassemble or oil any part of the CD player. Do not insert anything other than a disc into the slot.
- If coins or other foreign matter have been inserted into the disc slot, playback or ejection of a disc may be impossible. If a disc is removed forcibly, the disc or player may be damaged. If foreign matter has entered the player or a disc cannot be ejected, contact your SUBARU dealer.

1. Insert a disc into the disc slot.

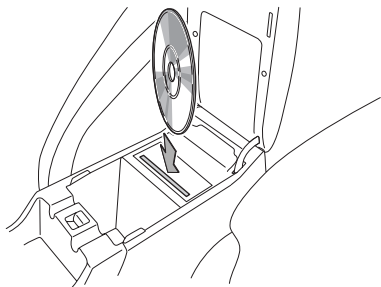

- After insertion, the disc is automatically loaded.

#### NOTE

- Compatible Disc: →P.177
- When inserting a disc, gently insert the disc with the label side facing the front of the vehicle.

### UNLOADING A DISC

1. Press  and remove the disc.

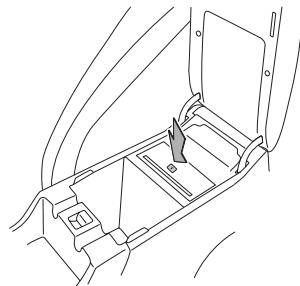

#### NOTE

- Discs can be unloaded even when the ignition switch is turned off.
- If the disc is not removed from the slot within 10 seconds of being ejected, it will automatically be pulled back into the slot.

## CONNECTING AND DISCONNECTING A USB MEMORY DEVICE/PORTABLE DEVICE

### CONNECTING A DEVICE

1. Connect a device.

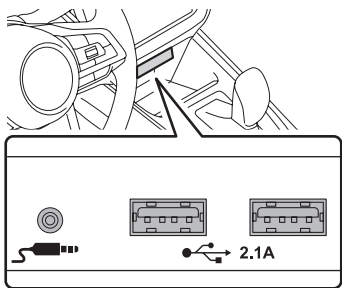





- Turn on the power of the device if it is not turned on.

#### NOTE

- Compatible USB memory device: →P.180
- Compatible iPod/iPhone: →P.180
- This unit does not support commercially available USB hubs.
- By connecting a device such as a cellular phone, charging starts depending on the device.

## TOUCH SCREEN GESTURES

Operations are performed by touching the touch screen directly with your finger.

Operation method	Outline	Main use
	<b>Touch</b> Quickly touch and release once.	Changing and selecting various settings
	<b>Double Touch with one finger*1</b> Quickly touch and release twice with one finger.	Enlarging the scale of the map screen
	<b>Drag*2</b> Touch the screen with your finger, and move the screen to the desired position.	<ul style="list-style-type: none"> <li>• Scrolling the lists</li> <li>• Scrolling the map screen*1</li> </ul>
	<b>Drag with two fingers*1</b> Touch the screen with two fingers and move the displayed screen as desired.	Changing the displayed angle of the 3D map screen

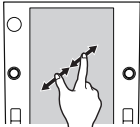

Operation method	Outline	Main use
	<p><b>Swipe</b><sup>*2</sup> Quickly move the screen by swiping with your finger.</p>	<ul style="list-style-type: none"> <li>• Scrolling the lists</li> <li>• Scrolling the map screen<sup>*1</sup></li> </ul>
	<p><b>Pinch</b><sup>*1</sup> Move your two fingers further apart (pinch-out) to zoom in the map. Move your two fingers closer together (pinch-in) to zoom out the map.</p>	<p>Changing the scale of the map screen</p>

\*1: 11.6-inch display with Navi system only

\*2: The above operations may not be performed on all screens.

## NOTE

- Swipe operations may not be performed smoothly in high altitudes.

## TOUCH SCREEN OPERATION

This system is operated mainly by the buttons on the screen. (Referred to as screen buttons in this manual.)

- When a screen button is touched, a tone sounds. The tone sound can be adjusted. (→P.90)



### ⚠ CAUTION

- To prevent damaging the screen, lightly touch the screen buttons with your finger.
- Do not use objects other than your finger to touch the screen.
- Wipe off fingerprints using a glass cleaning cloth. Do not use chemical cleaners to clean the screen, as they may damage the touch screen.

## NOTE

- If the system does not respond to touching a screen button, move your finger away from the screen and then touch it again.
- Dimmed screen buttons cannot be operated.
- The displayed image may become darker and moving images may be slightly distorted when the screen is cold.
- When it is extremely cold, screens may not be displayed properly and the data input by a user may be deleted. Also, the screen buttons may not operate correctly.

**NOTE**

- When  is displayed on the screen, select  to close a pop-up screen.
- If the touch screen is operated while wearing gloves, it may be unresponsive or may not function properly.

**ENTERING LETTERS AND NUMBERS/  
LIST SCREEN OPERATION****ENTERING LETTERS AND NUMBERS**

When entering data, letters and numbers can be entered via the screen.



1	Select to move the cursor.
2	Input field • The position of the cursor can be moved by selecting the desired location in the input field.
3	Select to clear the input field.
4	Select to erase one character.
5	Select to enter the item.
6	Select to change keyboard types.
7	Select to enter symbols.
8	Select to enter characters in lower case or in upper case.

**NOTE**

- The appearance of the keyboard may change or the input method may be limited depending on the circumstances where the software keyboard is displayed.

**LIST SCREEN OPERATION**

The list screen can be scrolled by a swipe gesture.

For details on the operation: →P. 66

► **11.6-inch display system/11.6-inch display with Navi system**

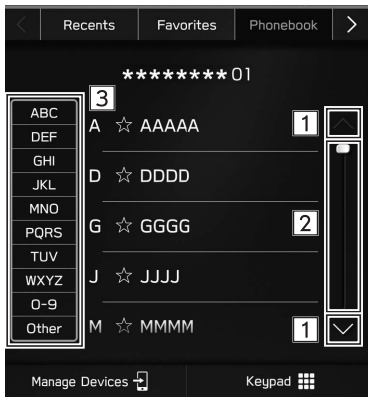

► **Dual 7.0-inch display system**



1	Select to skip to the next or previous page.
2	This indicates the displayed screen's position. Faster scrolling is possible by dragging the position indicator.
3	Some lists contain character screen buttons which allow users to jump directly to list entries that begin with the same letter as the character screen button. Every time the same character screen button is selected, the list starting with the subsequent character is displayed.

## SCREEN ADJUSTMENT

### ADJUSTING BRIGHTNESS

The brightness of the screen can be adjusted.  
Refer to the vehicle Owner's Manual for details.

### CHANGING BETWEEN DAY AND NIGHT MODE (11.6-inch display with Navi system only)



The screen mode of the map screen changes to day or night mode depending on the position of the headlight switch. The screen's mode also changes to day or night mode depending on the position of the illumination brightness control dial, and surrounding brightness.

## STATUS DISPLAY

The status of the Bluetooth connection, etc. is displayed on the screen.

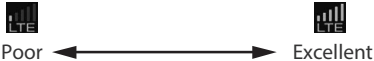

1	Display an outside temperature.
2	Display a current time. Select to display the clock setting screen.
3	This icon is displayed when the audio system volume is mute.
4 *1	This icon is displayed when a disc has been inserted.
5 *2	 <p>Display the level of Wi-Fi® reception. When Wi-Fi® function is off, no item is displayed.</p>

6 *2	 <p>Display the level of Wi-Fi® Hotspot reception. When Wi-Fi® Hotspot function is off, no item is displayed.</p>
7	This icon is displayed when the Bluetooth connection is established.
8	 <p>Display the level of phone reception. The level of reception does not always correspond with the level displayed on the cellular phone. The level of reception may not be displayed depending on the phone you have.</p>
9	 <p>Display the remaining of Bluetooth device battery charge. The amount displayed does not always correspond with the amount displayed on the Bluetooth device.</p>

\*1: If equipped with a CD player

\*2: 11.6-inch display system/11.6-inch display with Navi system only

## HOME SCREEN OPERATION

### ADDING SHORTCUT ICONS TO THE HOME SCREEN

Shortcut icons for various functions can be added to the home screen when the home screen shortcut function is turned on. (→P.83)



1. Display the home screen. (→P.18, 40)
2. Select **Add Shortcut** (Add Shortcut).
3. Select the desired function.
4. Select the desired shortcut function.
  - Depending on the function, select other items and enter necessary information.
5. Check that the shortcut icon is displayed on the home screen.

#### NOTE

- When shortcuts are added, the home screen can be expanded to up to 3 pages. The page can be changed by swiping.

### MOVING AND DELETING SHORTCUT ICONS

Users can rearrange the home screen buttons when the home screen shortcut function is turned on. (→P.83)

1. Select and hold the shortcut icon to enter edit mode.
  - ▶ **When moving shortcut icons**
2. Drag the button to the desired position.
  - User can move buttons to another page by dragging them to the corresponding end of the screen if the number of buttons allows for multiple pages.
- ▶ **When deleting shortcut icons**
2. Drag the button to “DRAG HERE TO DELETE” area.
3. Press  (Dual 7.0-inch display system) or select  (11.6-inch display system/11.6-inch display with Navi system) to leave the edit mode.

# 3 Settings

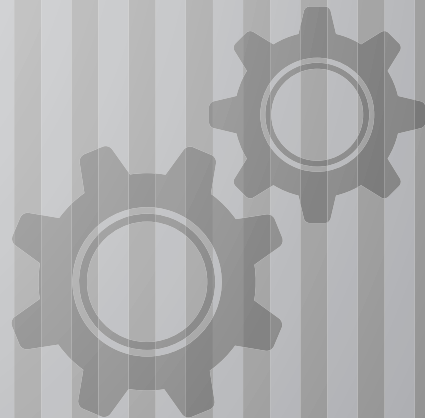

## **Bluetooth® Settings** 74

<b>Registering A Bluetooth Phone/ Device For The First Time</b> .....	74
Profiles .....	75
<b>Bluetooth Settings</b> .....	77
Phone Settings Screen .....	77
Registering A Bluetooth Phone/Device .....	78
Connecting Or Disconnecting	
Bluetooth Phone/Device .....	79
Deleting Bluetooth Phones/Devices .....	81
Setting Phonebook/Recent Calls Download .....	82

## **Other Settings** 83

<b>General Settings</b> .....	83
General Settings Screen .....	83
Setting Wi-Fi® Connection .....	85
Updating The System .....	88
<b>Sound Settings</b> .....	90
Sound Settings Screen .....	90
<b>Radio Settings</b> .....	91
Setting AM/FM Radio .....	91
Setting The SiriusXM® Radio .....	93

**Bluetooth® SETTINGS****REGISTERING A Bluetooth PHONE/  
DEVICE FOR THE FIRST TIME**

To use the hands-free system or the Bluetooth audio system, it is necessary to register a Bluetooth phone/device with the system.

Once the Bluetooth phone/device has been registered, it is possible to use the hands-free system and the Bluetooth audio system.

This operation cannot be performed while driving.

For details on registering a Bluetooth phone/device: →P.78

1. Turn the Bluetooth connection setting of your Bluetooth phone/device on.
  - This function is not available when the Bluetooth connection setting of your Bluetooth phone/device is set to off.
2. Display the phone screen. (→P.96)
3. Select **Yes** (Yes) to register a Bluetooth phone/device.

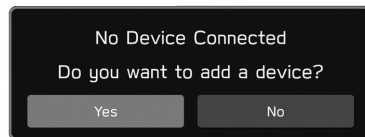

4. Follow the "STEPS 4 to 7" in "REGISTERING A Bluetooth PHONE/DEVICE". (→P.78)



## PROFILES

This system supports the following services.

Bluetooth Device	Spec.	Function	Requirements	Recommendations
Bluetooth Phone/Device	Bluetooth Specification	Registering a Bluetooth phone/device	Ver. 2.1	Ver. 4.2

Bluetooth Device	Profile	Function	Requirements	Recommendations
Bluetooth Phone	HFP (Hands-Free Profile)	Hands-free system	Ver. 1.0	Ver. 1.7
	PBAP (Phone Book Access Profile)	Transferring the contacts	Ver. 1.0	Ver. 1.2
	MAP (Message Access Profile)	Bluetooth phone message	-	Ver. 1.3
	SPP (Serial Port Profile)	APPS function	-	Ver. 1.2
Bluetooth Device	A2DP (Advanced Audio Distribution Profile)	Bluetooth audio system	Ver. 1.0	Ver. 1.3
	AVRCP (Audio/Video Remote Control Profile)		Ver. 1.0	Ver. 1.6

## NOTE

- If your cellular phone does not support HFP, registering the Bluetooth phone or using PBAP, MAP or SPP profiles individually will not be possible.
- If the connected Bluetooth phone/device version is older than recommended or incompatible, the Bluetooth phone/device function may not work properly.
- If the application is not running smoothly or is unstable, disconnect and reconnect the Bluetooth phone/device via Bluetooth (→P.79) and/or USB cable (→P.66). If the problem continues, reboot the Bluetooth phone/device.

## Bluetooth SETTINGS

1. Display the home screen. (→P.18, 40)
2. Select **Settings** (Settings).
3. → **Phone** (Phone)
4. Select the items to be set.

### PHONE SETTINGS SCREEN

Manage Devices	▶	1
Phonebook/Recent Calls	▶	2
Message	▶	3
Change Device Name	WRX ▶	4
Apple CarPlay	▶	5
Android Auto	▶	6

1	Registering a Bluetooth phone/device: →P.78
	Connecting or disconnecting Bluetooth phones/devices: →P.79
	Deleting Bluetooth phones/devices: →P.81

2	Setting phonebook/recent calls download: →P.82
	Sorting the recent calls list and contacts list: →P.101
	Deleting all favorites list: →P.102
3	Setting the message: →P.107
4	Changing the device name
5	Setting Apple CarPlay: →P.122
6	Setting Android Auto: →P.125

### NOTE

- “Manage Devices” screen can also be displayed by selecting **Manage Devices** (Manage Devices) or **Add Device** (Add Device) on the phone screen (→P.96) or Bluetooth audio control screen (→P.166).

## REGISTERING A Bluetooth PHONE/DEVICE

Up to 5 Bluetooth phones/devices can be registered.

Bluetooth compatible phones (HFP) and devices (AVP) can be registered simultaneously.

This operation cannot be performed while driving.

1. Display the phone settings screen. (→P.77)
2. Select **Manage Devices** (Manage Devices).
3. → **Add** (Add)
  - If a message appears, follow the guidance on the screen.

4. When this screen is displayed, search for the device name displayed on this screen on the screen of your Bluetooth phone/device.

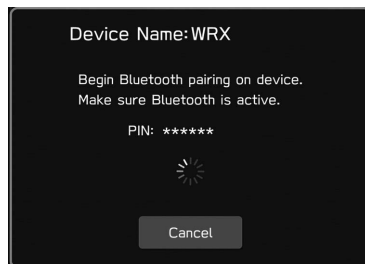

- **Cancel** (Cancel): Select to cancel the registration.
  - For details on operating the Bluetooth phone/device, see the manual that comes with it.
5. Register using your Bluetooth phone/device.
    - A PIN-code is not required for SSP (Secure Simple Pairing) compatible Bluetooth phones/devices. Depending on the type of Bluetooth phone/device being connected, a message confirming registration may be displayed on the Bluetooth phone's/device's screen. Respond and operate the Bluetooth phone/device according to the confirmation message.

**NOTE**

- To re-register your Bluetooth phone/device after having deleted it from the system, operate the Bluetooth phone/device and register it after deleting the previously registered system information from the Bluetooth phone/device.

6. Check that the following pop-up screen may be displayed.

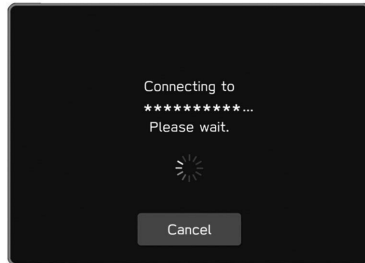

- **Cancel** (Cancel): Select to cancel the registration.
  - If a confirmation message appears asking whether to transfer the phone's contact data to the system, select the appropriate button.
7. When the connection is completed, confirm that a connected device name is displayed.
    - If an error message appears, follow the guidance on the screen to try again.

**NOTE**

- 11.6-inch display system/11.6-inch display with Navi system only: When registering an NFC compatible device, registration is performed when the Bluetooth phone/device is held against the NFC logo of the audio system until a connection is established.

## CONNECTING OR DISCONNECTING Bluetooth PHONE/DEVICE

Up to 5 Bluetooth phones/devices (Phones (HFP) and devices (AVP)) can be registered.

If more than 1 Bluetooth phone/device has been registered, select which Bluetooth phone/device to connect to.

1. Display the phone settings screen. (→P.77)
2. Select **Manage Devices** (Manage Devices).

3. Select the Bluetooth phone/device to be connected or disconnected.

► **11.6-inch display system/11.6-inch display with Navi system**

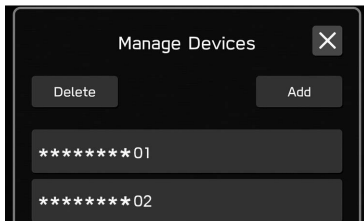

► **Dual 7.0-inch display system**

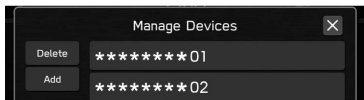

- To disconnect the Bluetooth phone/device, select **Yes** (Yes).
- “Connected” is displayed next to the currently connected Bluetooth phone/device.
- If the desired Bluetooth phone/device is not on the list, select **Add** (Add) to register the Bluetooth phone/device. (→P.78)

4. Check that “Connected” is displayed next to the Bluetooth phone/device when the connection is complete.
  - If an error message appears, follow the guidance on the screen to try again.

## NOTE

- It may take time if the Bluetooth phone/device connection is carried out during Bluetooth audio playback.
- Depending on the type of Bluetooth phone/device being connected, it may be necessary to perform additional steps on the Bluetooth phone/device.

---

## AUTO CONNECTION MODE

---

Leave the Bluetooth phone/device in a location where the connection can be established.

- When the ignition switch is turned to the “ACC” or “ON” position, the system searches for a nearby registered Bluetooth phone/device.
- The system will connect with the registered Bluetooth phone/device that was last connected, if it is nearby.

---

## CONNECTING MANUALLY

---

When the auto connection has failed, it is necessary to connect Bluetooth phones/devices manually.

Follow the “CONNECTING OR DISCONNECTING Bluetooth PHONE/DEVICE”. (→P.79)

---

## RECONNECTING THE Bluetooth PHONE/DEVICE

---

If a Bluetooth phone/device is disconnected due to poor reception from the Bluetooth network when the ignition switch is turned to the “ACC” or “ON” position, the system automatically reconnects the Bluetooth phone/device.

- If a Bluetooth phone/device is disconnected on purpose, such as turning it off, this does not happen. Reconnect the Bluetooth phone/device manually.

## DELETING Bluetooth PHONES/DEVICES

1. Display the phone settings screen. (→P.77)
2. Select **Manage Devices** (Manage Devices).
3. → **Delete** (Delete)
4. Select  for the Bluetooth phone/device you wish to delete.
5. Select **OK** (OK) when the confirmation message appears.

### NOTE

- The Bluetooth phone/device will still contain information from this system even after the Bluetooth phone/device has been deleted. Operate the Bluetooth phone/device to delete the system information saved inside the Bluetooth phone/device.

## SETTING PHONEBOOK/RECENT CALLS DOWNLOAD

When this function is activated, the phonebook data of the connected phone will be downloaded automatically.

1. Display the phone settings screen. (→P.77)
2. Select **Phonebook/Recent Calls** (Phonebook/Recent Calls).
3. Select to turn “Automatically Download Phonebook/Recent Calls” on/off.

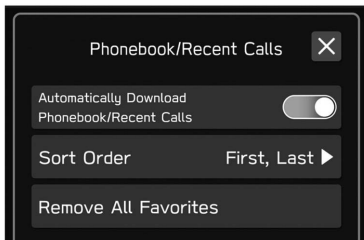

## NOTE

- The profile version of the connected Bluetooth phone may not be compatible with transferring phonebook data. For details, contact your SUBARU dealer.
- The notification setting on the Bluetooth phone may need to be activated in order to download the phonebook. For details, check the instructions for the connected Bluetooth phone. When the system's clock settings are set to auto, the auto-adjustment function and message function (→P.106) will not function properly if the phonebook is not downloaded.
- The Bluetooth phone's favorite list will not be downloaded automatically even after the phonebook data has been downloaded from the Bluetooth phone. This system does not currently support transfer of data from the Bluetooth phone favorites list. To add the Bluetooth phone's favorites list to the system's favorites list, you need to register it through the system phonebook contacts list. (→P.103)



## OTHER SETTINGS

## GENERAL SETTINGS

1. Display the home screen. (→P.18, 40)
2. Select **Settings** (Settings).
3. → **General** (General)
4. Select the items to be set.

## GENERAL SETTINGS SCREEN

For details about the following menu, refer to the vehicle Owner's Manual.

- **Clock** (Clock)
- **Display** (Display)
- **Reminder Screen** (Reminder Screen)
- **Meter Screen** (Meter Screen)
- **Camera** (Camera)
- **Climate Control** (Climate Control)
- **Language** (Language)
- **Tire Pressure Units** (Tire Pressure Units)
- **Welcome Screen** (Welcome Screen)
- **Goodbye Screen** (Goodbye Screen)
- **Favorite Widgets** (Favorite Widgets)

- **Birthday List** (Birthday List)
- **Anniversary List** (Anniversary List)



<b>Wi-Fi Settings</b> (Wi-Fi Settings)*1	Select to set the Wi-Fi® function settings. (→P.85)
<b>Wi-Fi Hotspot</b> (Wi-Fi Hotspot)*2*3	Select to set the Wi-Fi® Hotspot settings.
<b>Home Screen Shortcuts</b> (Home Screen Shortcuts)	Select to turn the home screen shortcuts function on/off. (→P.72)
<b>Periodic Rest Notification</b> (Periodic Rest Notification)*4	Select to turn the display for the periodic rest notification pop-up screen on/off. (→P.192)

<b>Software Update</b> (Software Update)*1	Select to update system software versions. (→P.88)
<b>SUBARU STARLINK Apps Recovery</b> (SUBARU STARLINK Apps Recovery)	Select to recover the SUBARU STARLINK.
<b>SUBARU STARLINK Auto Connect</b> (SUBARU STARLINK Auto Connect)*2	Select to turn the SUBARU STARLINK auto connect function on/off. (→P.115)
<b>Factory Data Reset</b> (Factory Data Reset)	Select to reset all setup items. The audio system restarts automatically after resetting factory data. To complete the reset process, turn the ignition switch to the "LOCK"/"OFF" position after the audio system has restarted, and then turn to the "ACC" or "ON" position after approximately 3 minutes.
<b>System Information</b> (System Information)	Select to display the system information.

<b>Free/Open Source Software Information</b> (Free/Open Source Software Information)	Select to display the free/open source software information.
---	--

\*1: 11.6-inch display system/11.6-inch display with Navi system only

\*2: If equipped

\*3: Refer to the Owner's Manual supplement for "SUBARU STARLINK Safety and Security" for details.

\*4: 11.6-inch display with Navi system only

## SETTING Wi-Fi® CONNECTION (11.6-inch display system/11.6-inch display with Navi system only)

### CONNECTING TO A Wi-Fi® NETWORK

1. Display the general settings screen. (→P.83)
2. Select **Wi-Fi Settings** (Wi-Fi Settings).
3. → **Available Wi-Fi Networks** (Available Wi-Fi Networks)
4. Select the desired network.

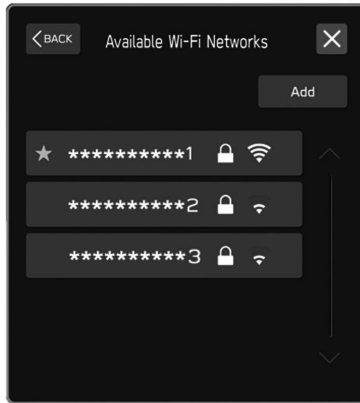

- When a network with **🔒** is selected and the password entry screen is displayed, enter the password, and then select **OK** (OK).

### SETTING UP A CONNECTION QUICKLY

If a Wi-Fi® device is Wi-Fi® Protected Setup compatible, it can be connected to more quickly.

1. Display the general settings screen. (→P.83)
2. Select **Wi-Fi Settings** (Wi-Fi Settings).
3. → **Wi-Fi Protected Setup** (Wi-Fi Protected Setup)
4. Select **PIN Setup** (PIN Setup) or **Push Button Setup** (Push Button Setup) as determined by the device.
5. Operate the Wi-Fi® device to connect.
  - When **PIN Setup** (PIN Setup) is selected: Enter the displayed PIN code into the Wi-Fi® network device.
  - When **Push Button Setup** (Push Button Setup) is selected: Push the WPS button on the Wi-Fi® network device.

---

## ADDING A Wi-Fi® NETWORK

---

Available networks which are not displayed by searching can be added.

1. Display the general settings screen. (→P.83)
2. Select **Wi-Fi Settings** (Wi-Fi Settings).
3. → **Available Wi-Fi Networks** (Available Wi-Fi Networks)
4. → **Add** (Add)
5. → **Wi-Fi Name (SSID)** (Wi-Fi Name (SSID))
6. Enter the network name. → **OK** (OK)
7. → **Security** (Security)
8. Select the security type.
9. → **Start Connection** (Start Connection)
  - When a password is required, enter the password. → **OK** (OK)

---

## DELETING A Wi-Fi® NETWORK

---

1. Display the general settings screen. (→P.83)
2. Select **Wi-Fi Settings** (Wi-Fi Settings).
3. Select **Wi-Fi** (Wi-Fi) to turn the Wi-Fi® function off.
4. → **Registered Wi-Fi Networks** (Registered Wi-Fi Networks)
5. → **Delete** (Delete)
6. Select  for the Wi-Fi® network you wish to delete. → **OK** (OK)

**! WARNING**

- Use Wi-Fi® devices only when safe and legal to do so.
- This system is fitted with Wi-Fi® antennas. People with implantable cardiac pacemakers, cardiac resynchronization therapy-pacemakers or implantable cardioverter defibrillators should maintain a reasonable distance between themselves and the Wi-Fi® antennas. The radio waves may affect the operation of such devices.
- Before using Wi-Fi® devices, users of any electrical medical device other than implantable cardiac pacemakers, cardiac resynchronization therapy-pacemakers or implantable cardioverter defibrillators should consult the manufacturer of the device for information about its operation under the influence of radio waves.

Radio waves could have unexpected effects on the operation of such medical devices.

**SUPPORTED Wi-Fi® NETWORK SPECIFICATIONS**

The system can connect to a Wi-Fi® network that supports the following standards.

- Communication standards:
  - 802.11b
  - 802.11g
  - 802.11n (2.4GHz)
- Security:
  - WPA™
  - WPA2™

**NOTE**

- WPA and WPA2 are registered mark of the Wi-Fi Alliance®.

## UPDATING THE SYSTEM

Please ask your dealer to update the system software\*<sup>1</sup>.

11.6-inch display system/11.6-inch display with Navi system only: You may also update the system software via Wi-Fi®. The update process involves downloading and installing a software update\*<sup>2</sup>. Note that system functionality will be restricted during installation.

\*<sup>1</sup>: Please check with your dealer for specific details on the update content.

\*<sup>2</sup>: Depending on the software update content, your radio station presets and volume settings may be reset by the update process.

### NOTE

- Update using Wi-Fi® may not be available in some countries.

## DOWNLOAD UPDATE

1. Display the home screen. (→P.40)
2. Select **Settings** (Settings).
3. → **General** (General)
4. → **Clock** (Clock) → **Time Setting** (Time Setting)
5. → **AUTO** (AUTO)\*<sup>1\*2</sup> or **Sync With Phone** (Sync With Phone)\*<sup>3</sup>
6. Connect to a Wi-Fi® network. (→P.85)
7. Display the general settings screen. (→P.83)
8. → **Software Update** (Software Update)
9. → **Update** (Update)
10. → **Check for Updates** (Check for Updates)
  - **Cancel** (Cancel): Select to stop checking for available updates.
  - If **Automatically Check for Updates** (Automatically Check for Updates) is on, updates will automatically be checked for and, if available, a message will be displayed. If a message is displayed, select **OK** (OK) and proceed to the next step.
  - If **Automatically Download Updates** (Automatically Download Updates) is on, updates will automatically be downloaded. After the download has completed, a message will be displayed. Select **OK** (OK) to start installation and proceed to STEP 3 in "UPDATE INSTALLATION". (→P.89)

11. Select **Download Now** (Download Now) to begin downloading the update (if available).
- **Cancel** (Cancel): Select to stop the update process.
  - The download status progress is displayed in the category area.
  - If the update procedure fails, refer to the "TROUBLESHOOTING" section. (→P.238)

\*1: 11.6-inch display with Navi system

\*2: 11.6-inch display system with SUBARU STARLINK Safety and Security

\*3: 11.6-inch display system without SUBARU STARLINK Safety and Security

## UPDATE INSTALLATION

### CAUTION

- Park your vehicle in a safe place when installing the update.
- The following system functions are restricted during the update installation.
  - It will not be possible to use general system functions.
  - Only the rear view camera image will be displayed. Or the image will disappear temporarily.

1. Download any available updates.
2. Select **Install Now** (Install Now) to start installing the update.
  - Installation will take several minutes.

### NOTE

- During software update installation, the screen may flicker. However, this is not a malfunction.
3. When installation is complete, select **OK** (OK) on the confirmation message to complete the update process.
    - If the update procedure fails, refer to the "TROUBLESHOOTING" section. (→P.238)
  4. Turn the ignition switch to the "LOCK"/"OFF" position → Open the driver's side door → Close the door → Wait for 3 minutes or more → Start the engine.
    - The new software will be applied.

## SOUND SETTINGS

1. Display the home screen. (→P.18, 40)
2. Select **Settings** (Settings).
3. → **Sound** (Sound)
4. Select the items to be set.

### SOUND SETTINGS SCREEN

Audio	▶	<b>1</b>
Navigation Guidance Volume	16 ▶	<b>2</b>
Notification Volume	19 ▶	<b>3</b>
Beep Sound Setting	<input type="checkbox"/> 4	<b>4</b>
Beep Sound Volume	11 ▶	<b>5</b>
Phone Ringtone Volume	16 ▶	<b>6</b>
Incoming Call Volume	18 ▶	<b>7</b>
Call Volume	0 ▶	<b>8</b>
SMS/MMS Ringtone Volume	19 ▶	<b>9</b>
SMS/MMS Read Out Volume	19 ▶	<b>10</b>
Voice Volume	19 ▶	<b>11</b>

**Sound Customization** (Sound Customization): Select to display the sound customization screen. (→P.138)

**Sound Restorer** (Sound Restorer)\*<sup>1</sup>: Select to turn the sound restorer function on/off.  
This function plays compressed audio with quality near original sound by adding the complement signal of high tone.

**Virtual Bass** (Virtual Bass)\*<sup>1</sup>: Select to set the virtual bass function.  
This function corrects the bass sound by adding harmonic sound.

**Dynamic Beat Enhancer** (Dynamic Beat Enhancer)\*<sup>1</sup>: Select to set the dynamic beat enhancer function.  
This function expands the dynamic range lost in data compression and creates a sharp beat sound.

**Speed Volume Control** (Speed Volume Control)\*<sup>1</sup>: Select to set the speed volume.  
The system adjusts to the optimum volume and tone quality according to vehicle speed to compensate for increased vehicle noise.

**AUX Volume Gain** (AUX Volume Gain): Select to set AUX volume gain.

**1**

**2**  
\*<sup>2</sup> Select to set the navigation prompt volume.

**3**

\*<sup>3</sup> Select to adjust the interrupt guidance volume.

**4**

Select to turn the tone sound on/off.



5	Select to adjust the tone sound volume.
6	Select to adjust the ringtone volume.
7	Select to adjust the volume of a received call.
8	Select to adjust the call volume.
9	Select to adjust the SMS/MMS ringtone volume.
10	Select to adjust the SMS/MMS read out volume.
11	Select to set the voice recognition prompts volume.

\*1: This setting can be made depending on the connected amplifier type.

\*2: 11.6-inch display with Navi system only

\*3: 11.6-inch display system/Dual 7.0-inch display system only

## RADIO SETTINGS

1. Display the home screen. (→P.18, 40)
2. Select **Settings** (Settings).
3. → **Radio** (Radio)

### SETTING AM/FM RADIO

1. Display the radio settings screen. (→P.91)
2. Select **AM** (AM) or **FM** (FM).
3. Select the desired item to be set.

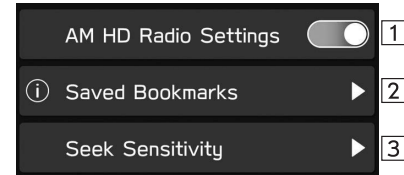

1	Select to turn the HD Radio mode on/off.
2	Select to display the saved bookmark list. (→P.92)
3 *	Select to set seek sensitivity of AM band as <b>DX (Distance)</b> (DX (Distance)) or <b>LO (Local)</b> (LO (Local)).

\*: AM radio only

---

## DISPLAYING THE BOOKMARK DETAILS

---

Cover art/track title/artist/album name are displayed for bookmarked tracks.



A QR code containing the track title/artist/album name can be displayed.

1. Display the AM settings screen or FM settings screen. (→P.91)
2. Select **Saved Bookmarks** (Saved Bookmarks).
3. Select the desired bookmark.

---

## DELETING THE BOOKMARK

---

1. Display the AM settings screen or FM settings screen. (→P.91)
2. Select **Saved Bookmarks** (Saved Bookmarks).
3. → **Edit** (Edit)
4. Select  for the bookmark you wish to delete. → **OK** (OK)
  - Deleting the bookmark can also be deleted select to  from the bookmark details screen.

## SETTING THE SiriusXM® Radio

1. Display the radio settings screen. (→P.91)
2. Select **SiriusXM** (SiriusXM).
3. Select the desired item to be set.

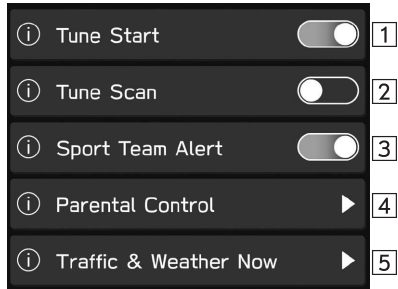

1	When this function is on, channels registered as Smart Favorites will be cached, and when the channel is changed, the song on that channel can be listened to from the beginning.
2	Select to enable/disable the search function for channels registered to Smart Favorites.
3	Select to turn the "Sport Team Alert" on/off. (→P.156)
4	Select to set the parental control passcode and locked channels. (→P.93, 94)
5	Select to set the city for which you wish to get information.

## SETTING THE PARENTAL CONTROL PASSCODE

1. Display the SiriusXM settings screen. (→P.93)
2. Select **Parental Control** (Parental Control).
3. Select **OK** (OK) when the confirmation message appears.
4. Enter the 4 digit passcode. → **OK** (OK)

---

## ADDING THE LOCKED CHANNELS

---

1. Display the SiriusXM settings screen. (→P.93)
2. Select **Parental Control** (Parental Control).
3. Enter the 4 digits passcode. → **OK** (OK)
4. → **Channel Lockout Selection** (Channel Lockout Selection)
  - “Lock All Mature Channels”: Select to lock all mature channels.
  - To add the locked channels, it is necessary to set the “Lock All Mature Channels” to off.
5. → **Add** (Add)
6. Select the desired channel to be set.
7. → **BACK** (BACK)

---

## CHANGING THE PARENTAL CONTROL PASSCODE

---

1. Display the SiriusXM settings screen. (→P.93)
2. Select **Parental Control** (Parental Control).
3. Enter the 4 digits passcode. → **OK** (OK)
4. → **Change Passcode** (Change Passcode)
5. Enter the 4 digits current passcode. → **OK** (OK)
6. Enter the 4 digits new passcode. → **OK** (OK)

---

## DELETING THE LOCKED CHANNEL

---

1. Display the SiriusXM settings screen. (→P.93)
2. Select **Parental Control** (Parental Control).
3. Enter the 4 digits passcode. → **OK** (OK)
4. → **Channel Lockout Selection** (Channel Lockout Selection)
  - To delete the locked channels, it is necessary to set the “Lock All Mature Channels” to off.
5. → **Edit** (Edit)
6. Select  for the channel you wish to delete. → **OK** (OK)
7. → **BACK** (BACK)

# 4 Phone



<b>Phone Operation</b>	96
<b>Phone Screen</b>	96
<b>Some Basics</b>	97
Registering/Connecting A Bluetooth Phone	98
Using The Phone Switch/Microphone	98
Voice Recognition System	99
About The Contacts In The Contact List	99
When Selling Or Disposing Of The Vehicle	100
<b>Calling On The Bluetooth Phone</b>	100
By Recent Calls List	101
By Favorites List	102
By Keypad	102
By Contacts List	103

<b>Receiving On The Bluetooth Phone</b>	103
Incoming Calls	103
<b>Talking On The Bluetooth Phone</b>	104
<b>Bluetooth Phone Message Function</b>	106
Setting The Message	107
Receiving A Message	107
Checking Messages	108
Replying To A Message (Quick Reply)	109
Sending A New Short Message	109
Editing The Quick Reply Message	109
Deleting The Quick Reply Message	110
Adding The Quick Reply Message	110
Calling The Message Sender	110

## PHONE OPERATION (HANDS-FREE SYSTEM FOR CELLULAR PHONES)

## PHONE SCREEN

The phone screen can be accessed with the following methods:

- Display the home screen (→P.18, 40), and then select **Phone** (Phone).
- Dual 7.0-inch display system only: Press **PHONE**.
- ▶ **11.6-inch display system/11.6-inch display with Navi system**

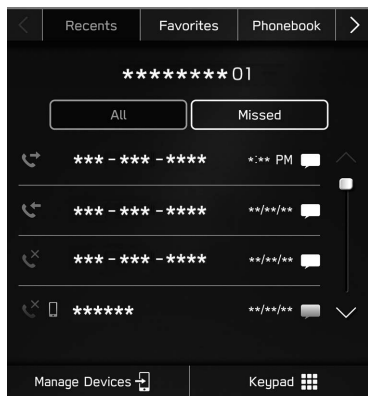

## ▶ Dual 7.0-inch display system

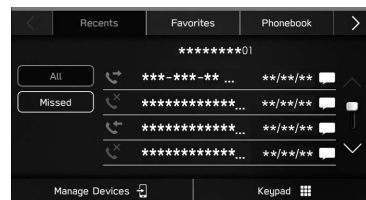

Phone operation	Registering a Bluetooth phone/device: →P.74
	Calling on the Bluetooth phone: →P.100
	Receiving on the Bluetooth phone: →P.103
	Talking on the Bluetooth phone: →P.104
Message function	Using the Bluetooth phone message function: →P.106
Setting up a phone	Setting the Bluetooth phone/device: →P.77

## SOME BASICS

The hands-free system enables calls to be made and received without having to take your hands off the steering wheel.

This system supports Bluetooth. Bluetooth is a wireless data system that enables cellular phones to be used without being connected by a cable or placed in a cradle.

The operating procedure of the phone is explained here.

### WARNING

- While driving, do not use a cellular phone or connect the Bluetooth phone.
- This system is fitted with Bluetooth antennas. People with implantable cardiac pacemakers, cardiac resynchronization therapy-pacemakers or implantable cardioverter defibrillators should maintain a reasonable distance between themselves and the Bluetooth antennas. The radio waves may affect the operation of such devices.
- Before using Bluetooth phones, users of any electrical medical device other than implantable cardiac pacemakers, cardiac resynchronization therapy-pacemakers or implantable cardioverter defibrillators should consult the manufacturer of the device for information about its operation under the influence of radio waves. Radio waves could have unexpected effects on the operation of such medical devices.

### CAUTION

- Do not leave your cellular phone in the vehicle. The temperature inside may rise to a level that could damage the phone.

### NOTE

- If your cellular phone does not support Bluetooth, this system cannot function. Certain functions may not be available depending on the type of cellular phone.
- In the following conditions, the system may not function:
  - The cellular phone is turned off.
  - The current position is outside the communication area.
  - The cellular phone is not connected.
  - The cellular phone has a low battery.
- When using the hands-free function and other Bluetooth functions at the same time, the following problems may occur:
  - The Bluetooth connection may be cut.
  - Noise may be heard when playing back voice with the Bluetooth function.
- The other party's voice will be heard from the front speakers. The audio system will be muted during phone calls or when hands-free voice commands are used.
- Talk alternately with the other party on the phone. If both parties speak at the same time, the other party may not hear what has been said. (This is not a malfunction.)
- Keep call volume down. Otherwise, the other party's voice may be audible outside the vehicle and voice echo may increase. When talking on the phone, speak clearly towards the microphone.

**NOTE**

- The other party may not hear you clearly when:
  - Driving on an unpaved road. (Making excessive traffic noise.)
  - Driving at high speeds.
  - Driving with a window open.
  - When air from the ventilator blows directly toward the microphone.
  - The sound of the air conditioning fan is loud.
  - There is a negative effect on sound quality due to the phone and/or network being used.

**REGISTERING/CONNECTING A Bluetooth PHONE**

To use the hands-free system for cellular phones, it is necessary to register a cellular phone with the system. (→P.74)

**Bluetooth PHONE CONDITION DISPLAY**

The condition of the Bluetooth phone appears on the upper right side of the screen. (→P.71)

**USING THE PHONE SWITCH/MICROPHONE****► Steering switch**

By pressing the phone switch, a call can be received or ended without taking your hands off the steering wheel.

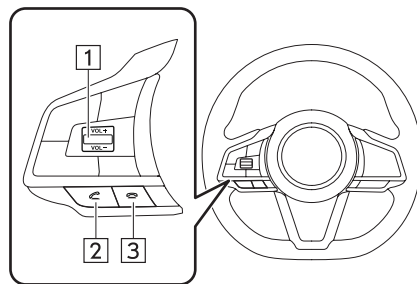

- 1 Volume control switch
  - Press the switch upwards to increase the volume.
  - Press the switch downwards to decrease the volume.
- 2 Off hook switch
- 3 On hook switch



### ► Microphone

The microphone is used when talking on the phone.

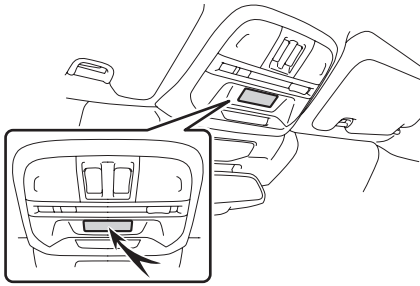

### VOICE RECOGNITION SYSTEM

Press this switch to operate the voice recognition system.

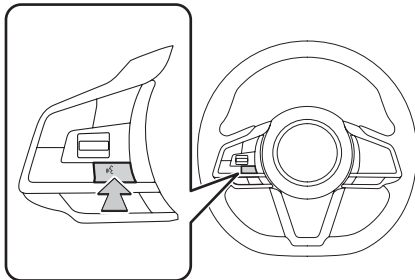

- The voice recognition system and its list of commands can be operated. (→P.218)

### ABOUT THE CONTACTS IN THE CONTACT LIST

- The following data is stored for every registered phone. When another phone is connected, the following registered data cannot be read:
  - Contact data
  - Call history data
  - Favorites data
  - All phone settings

### NOTE

- When a phone's registration is deleted, the above-mentioned data is also deleted.

## WHEN SELLING OR DISPOSING OF THE VEHICLE

A lot of personal data is registered when the hands-free system is used. When selling or disposing of the vehicle, reset all setup items. (→P.83)

- The following data in the system can be reset:
  - Contact data
  - Call history data
  - Favorites data
  - All phone settings

### NOTE

- Once reset, the data and settings will be erased. Pay close attention when resetting the data.

## CALLING ON THE Bluetooth PHONE

After a Bluetooth phone has been registered, a call can be made using the hands-free system. There are several methods by which a call can be made, as described below.

1. Display the phone screen. (→P.96)
2. Select the desired button to call from.
  - By recent calls list: →P.101
  - By favorites list: →P.102
  - By keypad\*<sup>1</sup>: →P.102
  - By contacts list: →P.103
  - By SMS/MMS: →P.110
  - By POI call\*<sup>2</sup>: →P.188
  - By voice recognition system: →P.218

\*<sup>1</sup>: The operation cannot be performed while driving.

\*<sup>2</sup>: 11.6-inch display with Navi system only

### NOTE

- If Siri is activated on an iPhone which is connected to the system via Bluetooth, a screen displaying an incoming call from the connected iPhone will be displayed. If the call is accepted, the iPhone can be operated using Siri.

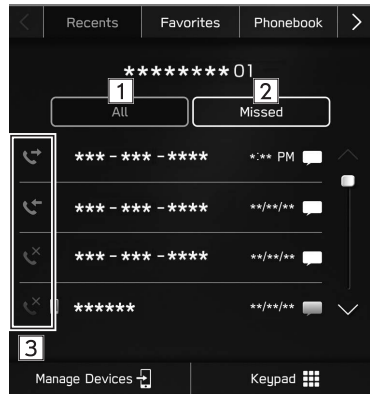

## BY RECENT CALLS LIST

1. Display the phone screen. (→P.96)
  2. Select **Recents** (Recents), and then select the desired contact.
    - The outgoing call screen is displayed.
- ▶ **11.6-inch display system/11.6-inch display with Navi system**



▶ **Dual 7.0-inch display system**



1	Select to display all latest call history items.
2	Select to display missed calls.
3	Displays the call type icons.  Missed call  Incoming call  Outgoing call

### NOTE

- When a phone number registered in the contact list is received, the name is displayed.
- International phone calls may not be made depending on the type of cellular phone you have.

## SORTING THE PHONEBOOK LIST

The order of the phonebook list can be sorted by first name or last name.

1. Display the phone settings screen. (→P.77)
2. Select **Phonebook/Recent Calls** (Phonebook/Recent Calls).
3. → **Sort Order** (Sort Order)
4. Select the desired sorting criteria.

## BY FAVORITES LIST

Calls can be made using registered contacts which can be selected from a contact list.

For details on registering contacts:→P.103

Up to 15 contact lists can be registered in the favorites list.

1. Display the phone screen. (→P.96)
2. Select **Favorites** (Favorites), and then select the desired contact.
3. Select  next to the desired number.
  - The outgoing call screen is displayed.

### NOTE

- This system's favorites list and that of your Bluetooth phone are not synchronized. This system does not currently support transfer of favorites list data from the Bluetooth phone. To add the Bluetooth phone's favorites list to the system's favorites list, you need to register it through the system phonebook contacts list. (→P.103)

## DELETING ALL FAVORITES LIST

1. Display the phone settings screen. (→P.77)
2. Select **Phonebook/Recent Calls** (Phonebook/Recent Calls).
3. → **Remove All Favorites** (Remove All Favorites) → **OK** (OK)

## BY KEYPAD

1. Display the phone screen. (→P.96)
2. Select **Keypad** (Keypad).
3. Enter the phone number. → **Call** (Call)
  - The outgoing call screen is displayed.

### NOTE

- Depending on the type of Bluetooth phone being connected, it may be necessary to perform additional steps on the phone.

## BY CONTACTS LIST

Calls can be made by using contact data which is transferred from a registered cellular phone.

1. Display the phone screen. (→P.96)
2. Select **Phonebook** (Phonebook), and then select the desired contact.
  - When ☆ is selected, ☆ changes to ★ (yellow).
    - The number is registered in the favorites list. (→P.102)
  - Each time the symbol is selected, the symbol changes between ☆ and ★ (yellow).
3. Select  next to the desired number.
  - Numbers may include Home, Work, Mobile and Other as categories depending on the phonebook data of the connected cellular phone.
  - The outgoing call screen is displayed.

### NOTE

- When “Automatically Download Phonebook/Recent Calls” is set to on, contacts is transferred automatically. (→P.82)

## RECEIVING ON THE Bluetooth PHONE

### INCOMING CALLS

When a call is received, the incoming call screen pops up with sound.

1. Select **Accept** (Accept) or press the  switch on the steering wheel to talk on the phone.

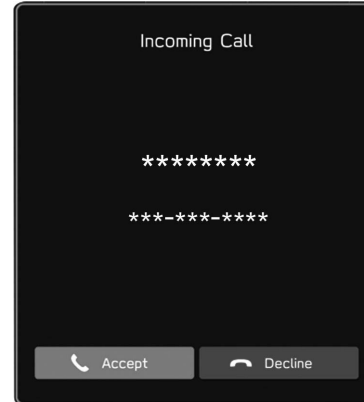

**To refuse to receive the call:** Select **Decline** (Decline) or press the  switch on the steering wheel.

**To adjust the volume of a received call:** Turn the “VOLUME” knob, or use the volume control switch on the steering wheel.

**NOTE**

- During international phone calls, the other party's name or number may not be displayed correctly depending on the type of cellular phone you have.
- The ringtone volume can also be set from the sound settings screen. (→P.90)

**TALKING ON THE Bluetooth PHONE**

While talking on the phone, this screen is displayed. The operations outlined below can be performed on this screen.

► **11.6-inch display system/11.6-inch display with Navi system**

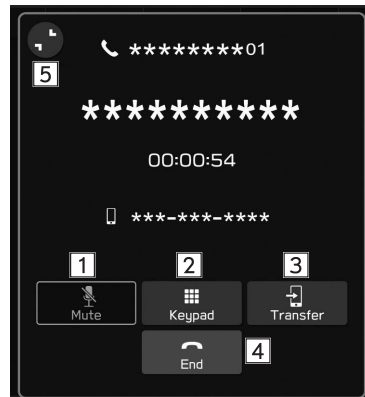

► **Dual 7.0-inch display system**

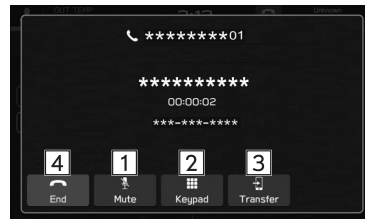

1	Select to mute your voice to the other party.
2	Select to enter the desired numbers/output tones. This operation cannot be performed while driving.
3	Select to transfer the call. Select <b>Transfer</b> (Transfer) to change from a hands-free call to a cellular phone call. Select <b>Transfer Back</b> (Transfer Back) to change from cellular phone call to hands-free call.
4	Select to hang up the phone.
5	Select to minimize the active call screen.

## NOTE



- Changing between cellular phone call and hands-free call can be performed by operating the cellular phone directly.
- Transferring methods and operations will be different depending on the type of cellular phone you have.
- For the operation of the cellular phone, see the manual that comes with it.
- Turn the “**VOLUME**” knob, or use the volume control switch on the steering wheel to adjust the volume of the other party's voice.

### ► In the case of accepting an interrupt incoming call during a call

The first call is put on hold.

- **Swap** (Swap): Select to change parties.
- Each time **Swap** (Swap) or name area is selected, or press the  switch on the steering wheel, the party who is on hold will be switched.

### ► When using another function during a call

By selecting  (11.6-inch display system/11.6-inch display with Navi system), or pressing  (Dual 7.0-inch display system), the active call screen will be minimized and other functions can be used.

- When the active call screen is minimized, only the call ending operation can be performed.
- By selecting  (11.6-inch display system/11.6-inch display with Navi system), or pressing **PHONE** (Dual 7.0-inch display system), the active call screen will be maximized.

## Bluetooth PHONE MESSAGE FUNCTION

Received messages can be forwarded from the connected Bluetooth phone, enabling checking and replying using the system.

Depending on the type of Bluetooth phone connected, received messages may not be transferred to the message inbox.

If the phone does not support the message function, this function cannot be used.

Depending on the Bluetooth phone type, the screen display may differ, and it may not be possible to use certain functions.

To use this function, it is necessary to set the phonebook download function to on. (→P.82)

### NOTE

- Depending on the model of your Bluetooth phone, the setting of the connected phone may need to be changed. (ex: For iOS or other models, the notification setting may need to be activated.) For details, check the instructions for the connected Bluetooth phone.

1. Display the phone screen. (→P.96)
2. Select **Messages** (Messages).
3. Check that the message inbox screen is displayed.

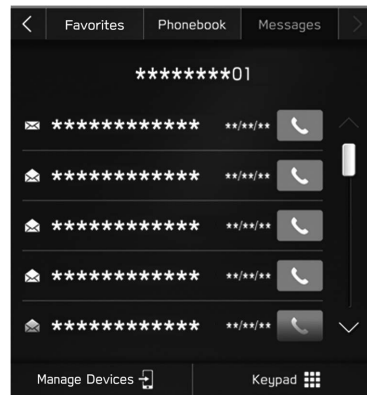

- : Unread message icon
- Receiving a message: →P.107
- Checking messages: →P.108
- Replying to a message (quick reply): →P.109
- Sending a new short message: →P.109
- Calling the message sender: →P.110



## SETTING THE MESSAGE

1. Display the phone settings screen. (→P.77)
2. Select **Messages** (Messages).
3. Select the items to be set.

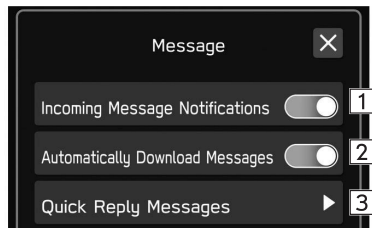

1	Select to set the incoming message notification pop-up on/off.
2	Select to set automatically download messages on/off.
3	Select to edit quick reply messages. (→P.109)

## RECEIVING A MESSAGE

When an SMS/MMS is received, the incoming message screen pops up with sound and is ready to be operated on the screen.

1. Select **Play** (Play).
  - Select **Ignore** (Ignore) to not open the message.

### ► If there are any unread messages

The following screen is displayed.



- **Inbox** (Inbox): Select to display the message inbox screen.
- **Ignore** (Ignore): Select to not open the message.

2. The following screen is displayed.

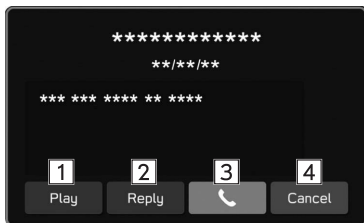

1	Select to have messages read out. • Select <b>Stop</b> (Stop) to stop the message read out.
2 *	Select to reply the message. (→P.109)
3	Select to call the message sender.
4	Select to close this screen.

\*: Depending on the Bluetooth phone that is connected to the audio system, this function is not available.

## NOTE

- Depending on the cellular phone used for receiving messages, or its registration status with the system, some information may not be displayed.

## CHECKING MESSAGES

1. Display the message inbox screen. (→P.106)
2. Select the desired message from the list.
3. Check the message. (→P.107)

## NOTE

- Depending on the type of Bluetooth phone being connected, it may be necessary to perform additional steps on the phone.
- Only received messages on the connected Bluetooth phone can be displayed.
- The text of the message is not displayed while driving.
- Turn the **"VOLUME"** knob, or use the volume control switch on the steering wheel to adjust the message readout volume.

## REPLYING TO A MESSAGE (QUICK REPLY)\*

\*: Depending on the Bluetooth phone that is connected to the audio system, this function is not available.

1. Display the message inbox screen. (→P.106)
2. Select the desired message from the list.
3. → **Reply** (Reply)
4. Select the desired message.
5. → **Send** (Send)
  - **Change** (Change): Select to change the message.
  - **Cancel** (Cancel): Select to cancel sending the message.

### NOTE

- 10 messages have already been stored.

## SENDING A NEW SHORT MESSAGE

1. Display the favorites detail screen (→P.102), the recent calls list screen (→P.101) or the contact detail screen (→P.103).
2. Select  next to the desired number.
3. Select the desired message.
4. → **Send** (Send)
  - **Change** (Change): Select to change the message.
  - **Cancel** (Cancel): Select to cancel sending the message.

## EDITING THE QUICK REPLY MESSAGE

### ► Editing the message in the phone settings screen

1. Display the phone settings screen. (→P.77)
2. Select **Messages** (Messages).
3. → **Quick Reply Messages** (Quick Reply Messages)
4. → **Edit** (Edit)
5. Select the desired message.
6. Enter the message. → **OK** (OK)

**▶ Editing the message in the message screen**

1. Display the message inbox screen. (→P.106)
2. Select the desired message from the list.
3. → **Reply** (Reply)
4. Select  next to the desired message.
5. Enter the message. → **OK** (OK)

**DELETING THE QUICK REPLY MESSAGE**

1. Display the phone settings screen. (→P.77)
2. Select **Messages** (Messages).
3. → **Quick Reply Messages** (Quick Reply Messages)
4. → **Edit** (Edit)
5. Select  next to the desired message.

**ADDING THE QUICK REPLY MESSAGE**

1. Display the phone settings screen. (→P.77)
2. Select **Messages** (Messages).
3. → **Quick Reply Messages** (Quick Reply Messages)
4. → **Add** (Add)
5. Enter the message. → **OK** (OK)

**CALLING THE MESSAGE SENDER**

Calls can be made to an SMS/MMS message sender's phone number.

1. Display the message inbox screen. (→P.106)
2. Select  next to the desired sender.
  - The outgoing call screen is displayed.

# 5 Apps

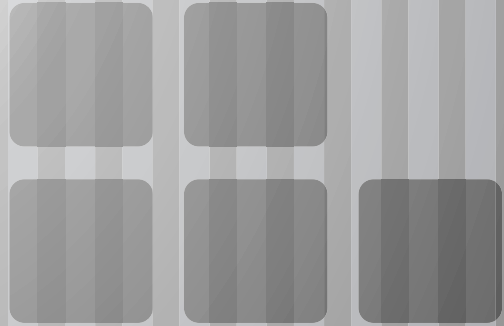

<b>Before Using Applications</b>	112
<b>Before Using Applications</b>	112
Settings Required To Use Applications	113
About App-based Connected Content	113
<b>SUBARU STARLINK</b>	115
<b>SUBARU STARLINK</b>	115
Displaying SUBARU STARLINK Information	116
Legal Notice	116

<b>Apple CarPlay</b>	121
<b>Apple CarPlay</b>	121
Connecting The Apple CarPlay Device	121
Overview	121
Selecting Device To Connect To	
Apple CarPlay	122
Deleting The Apple CarPlay Device	123

<b>Android Auto</b>	124
<b>Android Auto</b>	124
Connecting The Android Auto Device	124
Overview	124
Enabling Auto Show Of Android Auto Screen	125
Selecting Android Devices To Connect To	
Android Auto	125
Deleting The Android Auto Device	126

<b>SiriusXM Travel Link</b>	127
<b>SiriusXM Travel Link</b>	127
Displaying Sports Information	127
Displaying Weather Information	128
Displaying Weather Alerts	130
Displaying Stocks Information	131
Displaying Fuel Information	132
Displaying Parking Information	133

## BEFORE USING APPLICATIONS

## BEFORE USING APPLICATIONS

Precautions to be aware of when using applications are shown below.

In this chapter, iPhone or Android devices will be referred to as a smartphone.

 **WARNING**

- Do not connect or operate the smartphone while driving.
- Be sure to park the vehicle in a safe place before connecting or operating the smartphone.

 **CAUTION**

- Do not leave your smartphone in the vehicle. In particular, high temperatures inside the vehicle may damage the smartphone.
- Do not push down on or apply unnecessary pressure to the smartphone while it is connected as this may damage the smartphone or its terminal.
- If connecting your smartphone via USB, do not insert foreign objects into the USB port as this may damage the smartphone or its terminal.

**NOTE**

- Depending on the application, certain functions are not available while driving for reasons of safety.
- In order to maximize signal reception, performance and precision of the smartphone, please ensure the smartphone is placed as close to the system as possible, while ensuring it is stowed and secure while driving.
- When connecting your smartphone via USB, use the original cables provided with your smartphone or equivalent third-party (certified) cables.
- When the ignition switch is turned to the "ACC" or "ON" position, the battery of the connected smartphone is charged.
- If connecting your smartphone via USB, smartphone may not be recognized when the ignition switch is turned to the "ACC" or "ON" position. In this case, remove the smartphone and reconnect it.
- The accuracy of the displayed information or the signal reception performance depends on the smartphone or the connected device, and its wireless connection.
- For operating the smartphone, see the instruction manual that comes with it.
- Follow the specific operation procedures for the smartphone application.
- When connecting the device via Bluetooth, the communication speed may become slower than via USB.
- If the application is not running smoothly or is unstable, disconnect and reconnect the smartphone via Bluetooth (→P.79) and/or USB cable (→P.66). If the problem continues, reboot the smartphone.

## SETTINGS REQUIRED TO USE APPLICATIONS

In order to use an application on this system, the application must be installed on your smartphone.

- Search and download the application from your smartphone app.
  - iPhone: App Store via iTunes
  - Android device: Google Play Store
- Create an account and login to the application on the smartphone.

### NOTE

- Please use the latest version of the application.
- Apple CarPlay does not require an application to be installed. Refer to "Apple CarPlay" for details on Apple CarPlay operation. (→P.121)

## ABOUT APP-BASED CONNECTED CONTENT

Requirements for using the connected content services of the application on this system.

- The latest version of the system is compatible with connected content application(s) for the smartphones, and is downloaded to your smartphone.
- A current account with a wireless content service provider.
- A smartphone data plan: If the data plan for your smartphone does not provide for unlimited data usage, additional charges from your carrier may apply for accessing app-based connected content via 3G, 4G, Wi-Fi®, or 4G LTE wireless networks.
- Connection to the internet via 3G, 4G, Wi-Fi®, or 4G LTE networks.

### NOTE

- Changes to product specifications may result in differences between the content of the manual and features of the product.
- Be careful not to exceed the data usage limits for your smartphone. Doing so will result in additional data usage charges from your phone carrier.

## NOTE

- Limitations:
  - Access to app-based connected content will depend on the availability of wireless cellular and/or Wi-Fi® network coverage for the purpose of allowing your smartphone to connect to the internet.
  - Service availability may be geographically limited by region. Consult the wireless connected content service provider for additional information.
  - Ability of this product to access connected content is subject to change without notice and could be affected by any of the following: compatibility issues with future firmware versions of the smartphone; compatibility issues with future versions of the connected content application(s) for the smartphone; changes to or discontinuation of the connected content application(s) or service by its provider.
- Since some applications use signals from GPS satellites and wireless communication lines, they may not work properly in the following locations.
  - In tunnels
  - In underground parking lots
  - Outside wireless communication range, such as some countryside areas
  - Where the wireless communication network is congested, or where communications are restricted
- Depending on the circumstances and environment, the signal may be weak or not be received. In such cases, an error may occur.

## NOTE

- Communication and phone call charges for smartphones should be paid by the wireless subscriber.
- If you lose the data in a smartphone or other device while using it with the system, no compensation will be given for the lost data.
- SUBARU CORPORATION does not guarantee content provided by the application.
- The application may not work due to factors on smartphones, smartphone applications or stations. SUBARU CORPORATION accepts no responsibility for this.



## SUBARU STARLINK

## SUBARU STARLINK

The SUBARU STARLINK app allows users to connect a smartphone to the system, using either Bluetooth or undamaged genuine USB cable (recommended), and access to various music, navigation, vehicle guide applications, and much more.

Download the SUBARU STARLINK app from the Apple App Store or Google Play Store.

When connecting iPhone or Android devices with the SUBARU STARLINK application installed, you can control SUBARU STARLINK content through the system.

**To use the SUBARU STARLINK application, connect your iPhone to the USB port or via Bluetooth, or connect your Android device via Bluetooth.**

Dual 7.0-inch display system only: It is necessary to pair your smartphone via Bluetooth (→P.79), set the phonebook download function to on (→P.82), and then adjust the time so that it is the same at both your smartphone and the system.

When using the application, read the precautions indicated in "BEFORE USING APPLICATIONS". (→P.112)

### NOTE

- SUBARU CORPORATION reserves the right, in its sole and absolute discretion, to add, limit, or remove applications from SUBARU STARLINK at any time. Applications available at the time you purchase your vehicle may not remain available throughout your ownership of the vehicle.
- Review all terms and conditions, including all privacy policies, for any applications you access via SUBARU STARLINK. SUBARU CORPORATION is not responsible for any third party applications, including their use of data, their performance, or any other matter.
- SUBARU CORPORATION is not responsible for any charges, including any data charges from your carrier, resulting from your use of any application.
- SUBARU STARLINK may not be able to be used when connecting to an external Wi-Fi source from this system if the source IP address is 192.168.1.x.

## DISPLAYING SUBARU STARLINK INFORMATION

1. Run the SUBARU STARLINK application on your smartphone.
2. Connect the iPhone to the USB port, or connect your iPhone or Android device by utilizing the Bluetooth connection.
  - For details on connecting your iPhone to the USB port: →P.66  
For details on registering or connecting your iPhone or Android device: →P.74
3. Select **SUBARU STARLINK** (SUBARU STARLINK) on the Apps screen. (→P.27, 56)

### NOTE

- There may be times when **SUBARU STARLINK** (SUBARU STARLINK) does not appear immediately when the ignition switch is set in the "ACC" or "ON" position. If so, please wait.

---

## ABOUT THE SUPPORTED DEVICES

---

This system supports the following devices.

- iPhone: iOS 13 or later
- Android: Android 8 or later

### NOTE

- To ensure normal operation, updating your smartphone operating system to the latest version is recommended.

## LEGAL NOTICE

### ► For iPhone

- Caution  
For your safety, do not attempt to operate any feature of this device unless it is safe to do so without distraction from safe driving. This device is informational only. Check and abide by your local laws and always obey safe driving rules, and posted signs and signals. Operate this device only in locales in which it is legal. Read the instruction manual for proper operation of this device. This product uses the Smart Phone's data plan for features and services. Please consult carrier data plan usage, pricing, data overage charges, limitations and usage guidelines.
- Permission  
You may be asked to provide your personal and/or non-personal information solely for the purpose specified.

- Warranty Disclaimer

Any use of this product (the “Product”), the SUBARU STARLINK software, and any applications that are supported with the Product (collectively with the Product and the SUBARU STARLINK software, the “Product System”), including any reliance upon any of the content displayed by the Product System, shall be at your sole risk. SUBARU CORPORATION and its subsidiaries (“SUBARU CORPORATION”) disclaims any and all responsibility or liability for the accuracy, content, completeness, legality, reliability, or operability or availability of any information from the use of the Product System. The telecommunication network used and the particular version of the iPhone, Android or other smart phone (each, a “Smart Phone”) and the related Apple iOS, Android OS or other smart phone OS (collectively, the Smart Phone and the OS, the “Phone System”) used are the responsibility of the customer, and SUBARU CORPORATION shall have no responsibility for the interoperability of the Product System with any telecommunications network/Phone System combination not explicitly supported by SUBARU CORPORATION in written documentation of the Product System.

The user’s sole and exclusive remedies for any app downloaded from the iTunes Store, Google Play or other application stores (each, an “Application Store”) (including the SUBARU STARLINK app), or otherwise installed on customer’s Smart Phone, shall be as provided in the Application Store Terms and Conditions or other similar document and SUBARU CORPORATION assumes no responsibility for those apps or their operation. Any services provided by the Product System shall be covered by a separate Services Agreement.

TO THE FULLEST EXTENT PERMITTED UNDER APPLICABLE LAW, THE PRODUCT SYSTEM IS PROVIDED "AS IS" AND "AS AVAILABLE," WITHOUT WARRANTY OF ANY KIND, EITHER EXPRESS OR IMPLIED OR STATUTORY, INCLUDING THE IMPLIED WARRANTIES OF MERCHANTABILITY, FITNESS FOR A PARTICULAR PURPOSE, OR NON-INFRINGEMENT. SUBARU CORPORATION AND ITS AFFILIATES, OFFICERS, EMPLOYEES, AGENTS, PARTNERS, SUPPLIERS AND LICENSORS (COLLECTIVELY, "SUBARU CORPORATION PARTIES") DISCLAIM ANY AND ALL WARRANTIES REGARDING THE SECURITY, RELIABILITY, TIMELINESS, COMPLETENESS, ACCURACY AND PERFORMANCE OF THE PRODUCT SYSTEM. SUBARU CORPORATION PARTIES DO NOT WARRANT OR COVENANT THAT ANY DEFECTS OR ERRORS ASSOCIATED WITH THE PRODUCT SYSTEM WILL BE CORRECTED, OR THAT THE PRODUCT SYSTEM IS FREE OF VIRUSES, ERRORS, OR OTHER HARMFUL COMPONENTS, OR WILL OPERATE UNINTERRUPTED OR ON ANY SCHEDULE. BECAUSE SOME JURISDICTIONS DO NOT ALLOW THE EXCLUSION OF IMPLIED WARRANTIES, THE ABOVE EXCLUSION OF IMPLIED WARRANTIES MAY NOT APPLY TO YOU.

#### ► For Android devices

- Caution  
For your safety, do not attempt to operate any feature of this device unless it is safe to do so without distraction from safe driving. This device is informational only. Check and abide by your local laws and always obey safe driving rules, and posted signs and signals. Operate this device only in locales in which it is legal. Read the instruction manual for proper operation of this device. This product uses the Smart Phone's data plan for features and services. Please consult carrier data plan usage, pricing, data overage charges, limitations and usage guidelines.
- Permission  
You may be asked to provide your personal and/or non-personal information solely for the purpose specified.

- Warranty Disclaimer

Any use of this product (the “Product”), the SUBARU STARLINK software, and any applications that are supported with the Product (collectively with the Product and the SUBARU STARLINK software, the “Product System”), including any reliance upon any of the content displayed by the Product System, shall be at your sole risk. SUBARU CORPORATION and its subsidiaries (“SUBARU CORPORATION”) disclaims any and all responsibility or liability for the accuracy, content, completeness, legality, reliability, or operability or availability of any information from the use of the Product System. The telecommunication network used and the particular version of the iPhone, Android or other smart phone (each, a “Smart Phone”) and the related Apple iOS, Android OS or other smart phone OS (collectively, the Smart Phone and the OS, the “Phone System”) used are the responsibility of the customer, and SUBARU CORPORATION shall have no responsibility for the interoperability of the Product System with any telecommunications network/Phone System combination not explicitly supported by SUBARU CORPORATION in written documentation of the Product System.

The user’s sole and exclusive remedies for any app downloaded from the iTunes Store, Google Play or other application stores (each, an “Application Store”) (including the SUBARU STARLINK app), or otherwise installed on customer’s Smart Phone, shall be as provided in the Application Store Terms and Conditions or other similar document and SUBARU CORPORATION assumes no responsibility for those apps or their operation. Any services provided by the Product System shall be covered by a separate Services Agreement.

TO THE FULLEST EXTENT PERMITTED UNDER APPLICABLE LAW, THE PRODUCT SYSTEM IS PROVIDED "AS IS" AND "AS AVAILABLE," WITHOUT WARRANTY OF ANY KIND, EITHER EXPRESS OR IMPLIED OR STATUTORY, INCLUDING THE IMPLIED WARRANTIES OF MERCHANTABILITY, FITNESS FOR A PARTICULAR PURPOSE, OR NON-INFRINGEMENT. SUBARU CORPORATION AND ITS AFFILIATES, OFFICERS, EMPLOYEES, AGENTS, PARTNERS, SUPPLIERS AND LICENSORS (COLLECTIVELY, "SUBARU CORPORATION PARTIES") DISCLAIM ANY AND ALL WARRANTIES REGARDING THE SECURITY, RELIABILITY, TIMELINESS, COMPLETENESS, ACCURACY AND PERFORMANCE OF THE PRODUCT SYSTEM. SUBARU CORPORATION PARTIES DO NOT WARRANT OR COVENANT THAT ANY DEFECTS OR ERRORS ASSOCIATED WITH THE PRODUCT SYSTEM WILL BE CORRECTED, OR THAT THE PRODUCT SYSTEM IS FREE OF VIRUSES, ERRORS, OR OTHER HARMFUL COMPONENTS, OR WILL OPERATE UNINTERRUPTED OR ON ANY SCHEDULE. BECAUSE SOME JURISDICTIONS DO NOT ALLOW THE EXCLUSION OF IMPLIED WARRANTIES, THE ABOVE EXCLUSION OF IMPLIED WARRANTIES MAY NOT APPLY TO YOU.

## Apple CarPlay

### Apple CarPlay

Apple CarPlay can be used to view Apple Maps, play music, and place calls by connecting an Apple CarPlay device to the system. Supported applications can also be run.

- For details on the services or the operations, check the Apple CarPlay site (<https://www.apple.com/ios/carplay/>).

**To use the Apple CarPlay application, connect an Apple CarPlay device to the USB port.**

When using the application, read the precautions indicated in “BEFORE USING APPLICATIONS”. (→P.112)

#### NOTE

- Use an undamaged genuine USB cable when using this function.
- Enable Apple CarPlay in the Apple CarPlay device’s restriction settings before using this function.

### CONNECTING THE Apple CarPlay DEVICE

1. Connect an Apple CarPlay device to the USB port. (→P.66)
2. Check the confirmation message, and then select **Yes** (Yes).
  - The Apple CarPlay screen will be displayed.
  - If **No** (No) is selected, Apple CarPlay will not start, and the device will be recognized as an iPod/iPhone. (→P.162)
  - If “Don’t show again.” is selected, the confirmation message will not be displayed again. If the connected device cannot be used as an Apple CarPlay device, change the Apple CarPlay device connection settings. (→P.122)

### OVERVIEW

Select **Apple CarPlay** (Apple CarPlay) on the home screen or the apps screen (→P.18, 19, 40, 41) to display the Apple CarPlay screen.

## ► Control screen

### ► 11.6-inch display system/11.6-inch display with Navi system

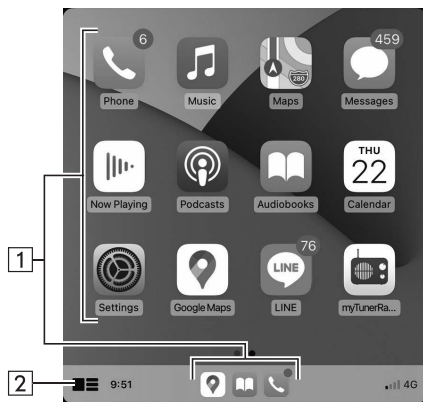

### ► Dual 7.0-inch display system

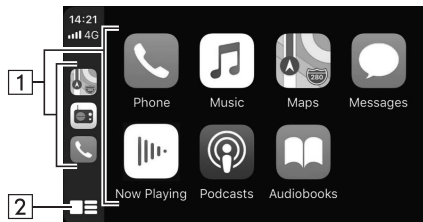

\*: The displayed screen will differ depending on the connected Apple CarPlay device.

1

Displays the application buttons.  
Select to start the application.

2

Select to change the home screen of Apple CarPlay.

## ABOUT THE SUPPORTED DEVICES

This system compatible with iOS 13.4 or later are supported.

## SELECTING DEVICE TO CONNECT TO Apple CarPlay

Whether a registered device connects as an Apple CarPlay device or an iPod/iPhone can be set.

This setting can be changed only if “Don’t show again.” was selected on the confirmation message displayed when an Apple CarPlay device was connected.

1. Display the phone settings screen. (→P.77)
2. Select **Apple CarPlay** (Apple CarPlay).
3. → **Device List** (Device List)
4. → **Edit** (Edit)
5. Select  for the desired Apple CarPlay device.
6. → **OK** (OK)



## DELETING THE Apple CarPlay DEVICE

This setting can be changed only if “Don’t show again.” was selected on the confirmation message displayed when an Apple CarPlay device was connected.

1. Display the phone settings screen. (→P.77)
2. Select **Apple CarPlay** (Apple CarPlay).
3. → **Device List** (Device List)
4. → **Edit** (Edit)
5. Select  next to the desired device name.
6. → **Yes** (Yes)
7. → **OK** (OK)

## Android Auto

### Android Auto

Android Auto can be used to view Google Maps, play music, and place calls by connecting your Android device to the system, using USB cable and Bluetooth. Supported applications can also be run.

- For details on the services or the operations, check the Android Auto site (<https://www.android.com/auto/>) and (<https://support.google.com/androidauto/>).

**To use the Android Auto application, connect your Android device to the USB port.**

When using the application, read the precautions indicated in “BEFORE USING APPLICATIONS”. (→P.112)

#### NOTE

- Use an undamaged genuine USB cable when using this function.
- To use this function, check to make sure that your Android device is set to accept connection with a new vehicle.
- Depending on the model, the talkback volume of the voice recognition function of Android Auto may differ from the volume setting of other functions. Set the volume to a level that is easy to hear.

### CONNECTING THE Android Auto DEVICE

1. Connect an Android Auto device to the USB port. (→P.66)
2. Check the confirmation message, and then select **Yes** (Yes).
  - The Android Auto screen will be displayed.
  - If **No** (No) is selected, Android Auto will not start.
  - If “Don’t show again.” is selected, the confirmation message will not be displayed again.  
If the connected device cannot be used as an Android Auto device, change the Android Auto device connection settings. (→P.125)

### OVERVIEW

Select **Android Auto** (Android Auto) on the home screen or the apps screen (→P.18, 19, 40, 41) to display the Android Auto screen.

## ► Control screen

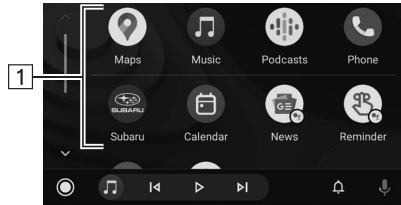

1

Displays the application buttons.  
Select to start the application.

## ABOUT THE SUPPORTED DEVICES

This system compatible with Android 8.1 or later are supported.

## ENABLING AUTO SHOW OF Android Auto SCREEN

Automatic display of the Android Auto screen when an Android device is connected to the system via USB, can be enabled/disabled.

1. Display the phone settings screen. (→P.77)
2. Select **Android Auto** (Android Auto).
3. Turn "Auto Show Connected Device" on.

## SELECTING Android DEVICES TO CONNECT TO Android Auto

Whether a registered Android device connects as an Android Auto device or a USB memory device can be set.

1. Display the phone settings screen. (→P.77)
2. Select **Android Auto** (Android Auto).
3. → **Device List** (Device List)
4. → **Edit** (Edit)
5. Select  for the desired Android device.

## DELETING THE Android Auto DEVICE

1. Display the phone settings screen. (→P.77)
2. Select **Android Auto** (Android Auto).
3. → **Device List** (Device List)
4. → **Edit** (Edit)
5. Select  next to the desired device name.
6. → **Yes** (Yes)
7. → **OK** (OK)

## SiriusXM Travel Link

### SiriusXM Travel Link\*

\*: SiriusXM U.S. satellite and data services are available only in the 48 contiguous USA and DC. SiriusXM satellite service is also available in Canada; see [www.siriusxm.ca](http://www.siriusxm.ca).

Data service information, which is comprised of sports information, weather information, stock information, parking information and fuel information, can be received via the SiriusXM® Radio.

To receive the data service information in the vehicle, a subscription to the SiriusXM® Radio Service is necessary following a free trial. (→P.150)

Content that uses the SiriusXM® Radio Service is reset when personal information is initialized by selecting **Factory Data Reset** (Factory Data Reset) at the "GENERAL SETTINGS SCREEN". (→P.83)

### DISPLAYING SPORTS INFORMATION

Sports information such as games and results, the status of games still in progress, and future game schedules can be displayed.

1. Select **Travel Link** (Travel Link) on the Apps screen. (→P.27, 56)
2. → **Sports** (Sports)

### 3. Check that sports information is displayed.

#### ► 11.6-inch display system/11.6-inch display with Navi system

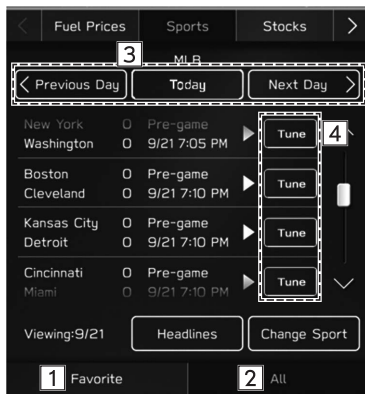

#### ► Dual 7.0-inch display system



1	Select to display the favorite teams information. <b>Favorite Team</b> (Favorite Team): Select to register, edit or select your favorite team.
2	Select to display all information for a selected sport. <b>Headlines</b> (Headlines): Select to display the headlines. <b>Change Sport</b> (Change Sport): Select to change the sport.
3	Select to change the displayed information.
4	Select to listen to a broadcast.

## DISPLAYING WEATHER INFORMATION

Weather forecasts, forecast temperature or highest/lowest temperature, and the chances of precipitation, etc. can be displayed in weather information.

1. Select **Travel Link** (Travel Link) on the Apps screen. (→P.27, 56)
2. → **Weather** (Weather)

### 3. Check that weather information is displayed.

#### ► 11.6-inch display system/11.6-inch display with Navi system

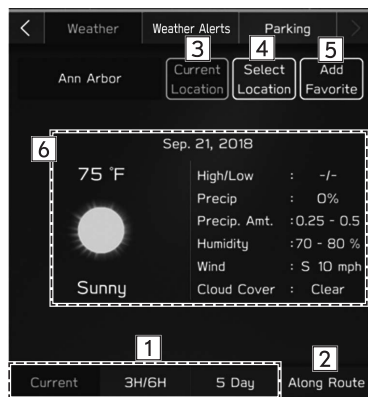

#### ► Dual 7.0-inch display system



1	Select to switch the timing of the displayed forecast.
2 *	Select to display the weather forecast for the route being travelled during route guidance.
3 *	Select to display the weather forecast from your current location to your destination.
4	Select to change the region which information will be displayed. The region can be selected from registered favorites or a full list of regions.
5	Select to add the currently displayed location as a favorite.
6	Weather information is displayed.

\*: 11.6-inch display with Navi system only

## DISPLAYING WEATHER ALERTS

Weather alerts can be displayed.

1. Select **Travel Link** (Travel Link) on the Apps screen.  
(→P.27, 56)
2. → **Weather Alerts** (Weather Alerts)

3. Check that weather alerts are displayed.  
▶ **11.6-inch display system/11.6-inch display with Navi system**



- ▶ **Dual 7.0-inch display system**

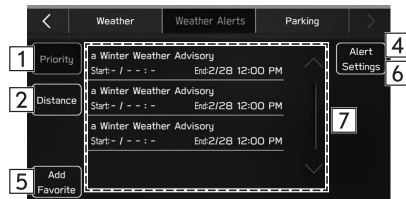



1	Select to sort weather alerts by priority.
2	Select to sort weather alerts by distance.
3*	Select to display the weather alerts from your current location to your destination.
4	Select to change the region which information will be displayed. The region can be selected from registered favorites or a full list of regions.
5	Select to add the favorite regions list.
6	Select to set the alert types, zone and notifications.
7	Weather alerts are displayed.

\*: 11.6-inch display with Navi system only

## DISPLAYING STOCKS INFORMATION

Company names, stock prices, and price fluctuations can be displayed in stock information. Fluctuations greater than zero are displayed with green arrows, and fluctuations less than zero are displayed with red arrows.

1. Select **Travel Link** (Travel Link) on the Apps screen. (→P.27, 56)
2. → **Stocks** (Stocks)

3. Check that stock information is displayed.

### ► 11.6-inch display system/11.6-inch display with Navi system

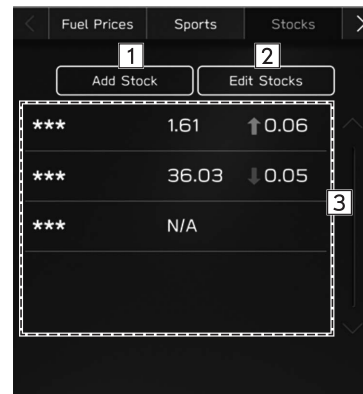

### ► Dual 7.0-inch display system



1	Select to add stocks.
2	Select to delete stocks.
3	Stock information is displayed.

## DISPLAYING FUEL INFORMATION

Gas station information can be displayed, and gas stations can be set\* as the destination. When Bluetooth is enabled on your cellular phone, calls can be placed if the displayed information screen contains phone number information.

\*: 11.6-inch display with Navi system only

1. Select **Travel Link** (Travel Link) on the Apps screen. (→P.27, 56)
2. → **Fuel Prices** (Fuel Prices)

3. Check that fuel information is displayed.

### ▶ 11.6-inch display system/11.6-inch display with Navi system



### ▶ Dual 7.0-inch display system



1 *	Select to sort the display order of gas stations by distance from the current position.
2	Select to sort the display order of gas stations by price.
3	Select to sort the display order of gas stations by brand.
4	Select to change the location for which fuel information is displayed.
5	Select to set the fuel type.
6	Select to change the country which information will be displayed.
7 *	Select to update the gas station information.
8	Select to display information about a gas station and be able to add it to favorites.
9	Select to display the favorite gas stations list.
10 *	Select to display the currently displayed gas stations on the map.

\*: 11.6-inch display with Navi system only

## DISPLAYING PARKING INFORMATION

Parking information can be displayed, and parking can be set\* as the destination. When Bluetooth is enabled on your cellular phone, calls can be placed if the displayed information screen contains phone number information.

\*: 11.6-inch display with Navi system only

1. Select **Travel Link** (Travel Link) on the Apps screen. (→P.27, 56)
2. → **Parking** (Parking)

### 3. Check that parking information is displayed.

#### ▶ 11.6-inch display system/11.6-inch display with Navi system

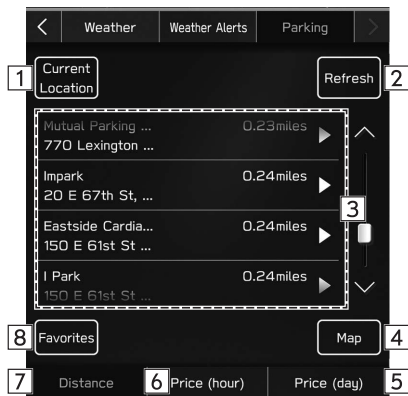

#### ▶ Dual 7.0-inch display system



1	Select to change the region which information will be displayed.
2 *	Select to update the parking information.
3	Select to display information about a parking lot and be able to add it to favorites.
4 *	Select to display the currently displayed parking lots on the map.
5	Select to sort parking lots by price per day.
6	Select to sort parking lots by price per hour.
7 *	Select to sort the display order of parking lots by distance from the current position.
8	Select to display the favorite parking lots list.

\*: 11.6-inch display with Navi system only

# 6 Audio

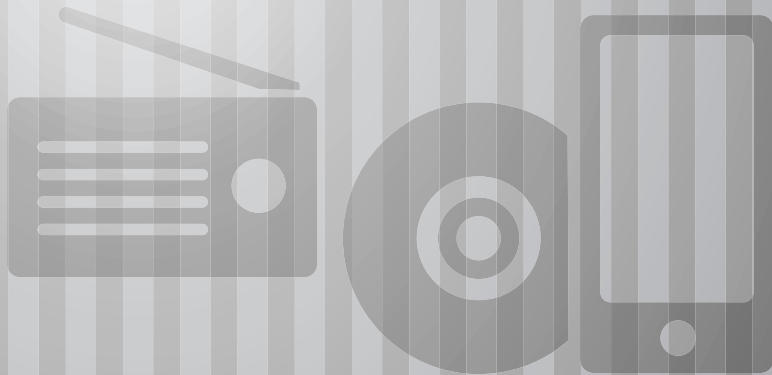

## Basic Operation 136

<b>Some Basics</b> .....	136
Turning The System On And Off .....	136
Selecting An Audio Source .....	137
Sound Settings .....	138
Voice Recognition System .....	142

## Radio Operation 143

<b>AM/FM Radio</b> .....	143
Overview .....	143
Registering A Station As A Preset .....	144
Selecting A Station From The List .....	144
Radio Broadcast Data System .....	145
Available HD Radio™ Technology .....	145
Caching Radio Programs .....	147

<b>SiriusXM® Radio</b> .....	149
Overview .....	149
How To Subscribe To SiriusXM® Radio .....	150
Displaying The Radio ID .....	153
Presetting A Channel .....	153
Caching Radio Programs .....	153
Selecting A Channel From The List .....	155
Setting Teams For Notifications .....	156
Setting TuneMix Channels .....	157

## Media Operation 158

<b>CD</b> .....	158
Overview .....	158
<b>USB Memory</b> .....	160
Overview .....	160
<b>iPod/iPhone</b> .....	162
Connecting The iPod/iPhone .....	162
Overview .....	162

<b>Bluetooth Audio</b> .....	165
Overview .....	165
Connecting A Bluetooth Device .....	168
<b>AUX</b> .....	168
Overview .....	168
<b>Android Auto</b> .....	170
Connecting An Android Auto Device .....	170
Overview .....	170

## Audio Remote Controls 173

<b>Steering Wheel Controls</b> .....	173
--------------------------------------	-----

## Tips For Operating The Audio System 175

<b>Operating Information</b> .....	175
Radio .....	175
CD Player And Disc .....	177
USB Memory Device .....	180
iPod/iPhone .....	180
File Information .....	181

## BASIC OPERATION

## SOME BASICS

This section describes some of the basic features of the audio system. Some information may not pertain to your system.

Your audio system works when the ignition switch is turned to the "ACC" or "ON" position.

**CAUTION**

- To prevent the battery from being discharged, do not leave the audio system on longer than necessary when the engine is not running.

## TURNING THE SYSTEM ON AND OFF



"VOLUME" knob: Press and hold until a message is displayed, and then select **OK** (OK) or wait a few seconds for the audio system to turn off. Press and hold to turn the system on again. The system will turn on with the last audio source used. Turn this knob to adjust the volume. Press to mute the audio system.

► **Dual 7.0-inch display system only**

**RADIO** **MEDIA**: Press to display screen buttons for the audio system.

**NOTE**

- The audio system will remain off if you change the position of the ignition switch from "LOCK"/"OFF" to "ACC"/"ON" while the audio system is off. If you had set the volume to mute, the audio system will remain mute and the track will start playing from where it was last stopped.

## SELECTING AN AUDIO SOURCE

### ▶ 11.6-inch display system/11.6-inch display with Navi system

1. Display the home screen. (→P.40)
2. Select **Radio** (Radio) or **Media** (Media).
3. Select the desired audio source.



<Radio screen>

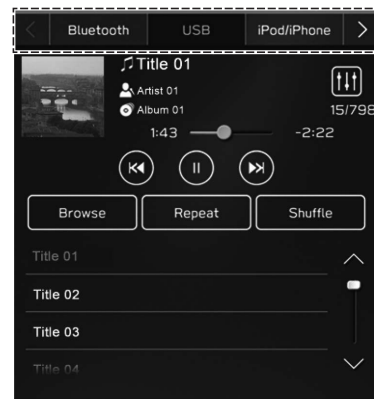

<Media screen>

### ► Dual 7.0-inch display system

1. Press **RADIO** or **MEDIA**.
2. Select the desired audio source.



<Radio screen>

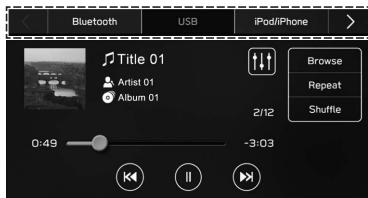

<Media screen>

- Each time **RADIO** or **MEDIA** is pressed, the audio source can also be changed.

## SOUND SETTINGS

### DISPLAYING THE SOUND CUSTOMIZATION SCREEN

1. Display the home screen. (→P.18, 40)
2. Select **Settings** (Settings).
3. → **Sound** (Sound)
4. → **Audio** (Audio)
5. → **Sound Customization** (Sound Customization)

### EQUALIZER SETTINGS

How good an audio program sounds is largely determined by the mix of the treble, mid and bass levels. In fact, different kinds of music and vocal programs usually sound better with different mixes of treble, mid and bass.

1. Display the “Sound Customization” screen. (→P.138)
2. Select **Equalizer** (Equalizer).



## 3. Set the desired item.

## ▶ 11.6-inch display system/11.6-inch display with Navi system

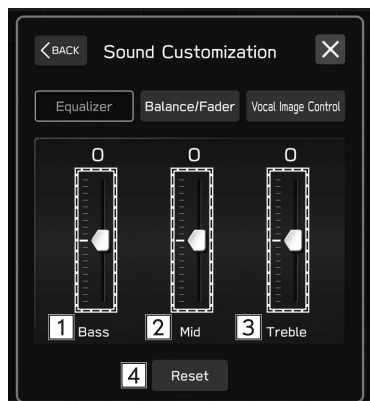

## ▶ Dual 7.0-inch display system

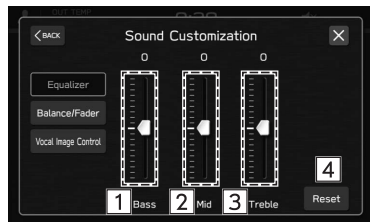

1	Select the sliders to adjust low-pitched tones.
2	Select the sliders to adjust mid-pitched tones.
3	Select the sliders to adjust high-pitched tones.
4	Select to reset all setup items.

**BALANCE/FADER SETTINGS**

A good balance of the left and right stereo channels and of the front and rear sound levels is also important.

Keep in mind that when listening to a stereo recording or broadcast, changing the right/left balance will increase the volume of 1 group of sounds while decreasing the volume of another.

1. Display the "Sound Customization" screen. (→P.138)
2. Select **Balance/Fader** (Balance/Fader).

### 3. Adjust to the desired position.

#### ▶ 11.6-inch display system/11.6-inch display with Navi system

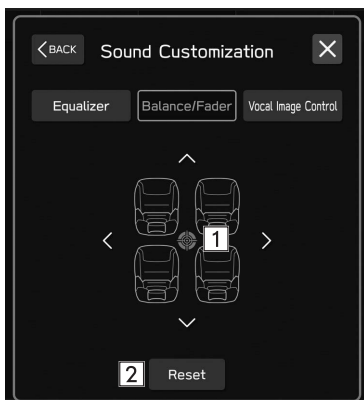

#### ▶ Dual 7.0-inch display system

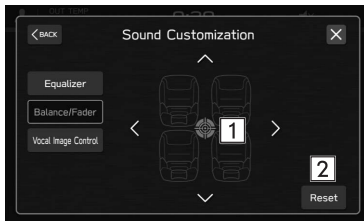

1 Select the icon to adjust sound balance.

2 Select to reset the adjusted position.

### VOCAL IMAGE CONTROL SETTINGS\*

\*: This setting can be made depending on the connected amplifier type.

Extract only vocal sound from whole sound and adjust volume balance of it.

1. Display the "Sound Customization" screen. (→P.138)
2. Select **Vocal Image Control** (Vocal Image Control).

### 3. Adjust to the desired position.

#### ► 11.6-inch display system/11.6-inch display with Navi system

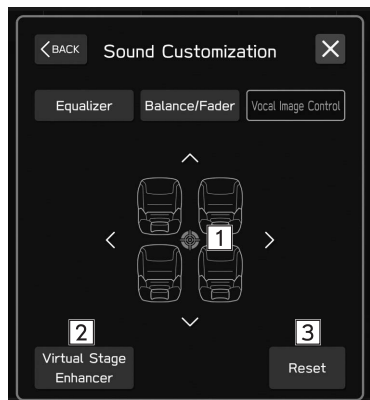

#### ► Dual 7.0-inch display system

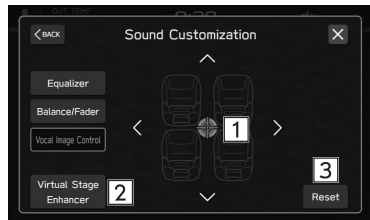

1	Select the icon to adjust vocal image control.
2	Select to set the virtual stage enhancer function. This function adjusts the sounds to the high realistic surround sound by enhancing the vocals. When this setting is on, the front and rear setting of "Vocal Image Control" cannot be set.
3	Select to reset the vocal image control settings.

## VOICE RECOGNITION SYSTEM

1. Press this switch to operate the voice recognition system.

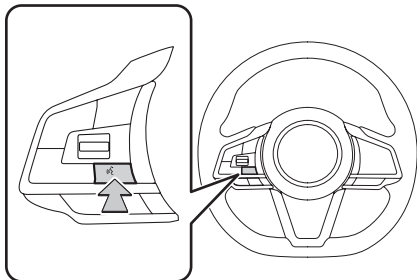

- The voice recognition system and its list of commands can be operated. (→P.218)

## RADIO OPERATION

## AM/FM RADIO

## OVERVIEW

The FM/AM radio operation screen can be accessed by selecting **FM** (FM) or **AM** (AM) on the radio control screen. (→P.137)

## ▶ Control panel



<b>1</b>	Turn to adjust the volume. Press to mute the audio system. Press and hold to turn the audio system off, and press and hold to turn it on again.
<b>2</b>	Turn to step up/down frequencies. Press and hold to display the sound customization screen. (→P.138)

## ▶ Control screen

## ▶ 11.6-inch display system/11.6-inch display with Navi system

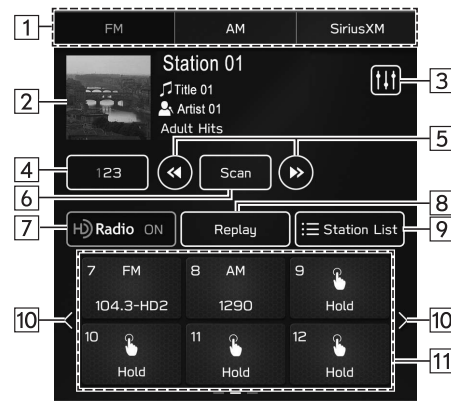

## ▶ Dual 7.0-inch display system

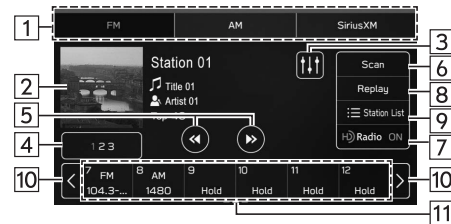

1	Select to change radio modes.
2	Press and hold to save a specific song to your Bookmark List. (→P.91)
3	Select to display the sound customization screen. (→P.138)
4 *	Select to change multicast channels available. (→P.146)
5	Select to step up/down frequencies. Select and hold to seek frequencies.
6	Select to scan for receivable stations/channels. The scan will continue until selected again.
7	Select to turn HD Radio mode on/off.
8	Select to display the cache radio operation buttons. (→P.147)
9	Select to display a list of receivable stations. (→P.144)
10	Select to scroll the list of preset buttons.
11	Select to tune to preset stations/channels. The preset station list can be scrolled by swiping the list.

\*: FM Radio only

## NOTE

- The radio automatically changes to stereo reception when a stereo broadcast is received.
- When the HD Radio mode is on, the radio automatically tunes to an HD Radio signal in AM or FM where available.

## REGISTERING A STATION AS A PRESET

Multiple stations can be registered as presets.

1. Tune to the desired station.
2. Select and hold one of the desired preset station buttons.
  - To change the preset station to a different one, follow the same procedure.

## SELECTING A STATION FROM THE LIST

A station list can be displayed.

1. Select **Station List** (Station List).
  - **Update** (Update): Select to update the station list.
- ▶ **FM only**
  2. Select the desired list.
    - **All** (All): Select to display all stations.
    - **Genres** (Genres): Select to display categories.
  3. Select the desired station.

## RADIO BROADCAST DATA SYSTEM

This audio system is equipped with Radio Broadcast Data Systems (RBDS).

RBDS mode allows text messages to be received from radio stations that utilize RBDS transmitters.

RBDS features are available only when listening to an FM station that broadcasts RBDS information.

## AVAILABLE HD Radio™ TECHNOLOGY

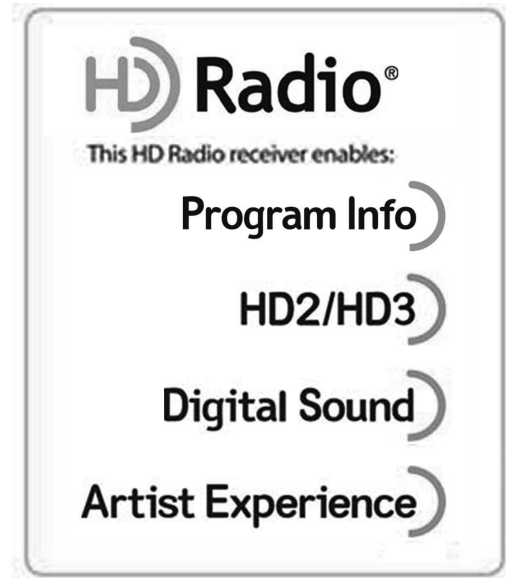

HD Radio Technology manufactured under license from iBiquity Digital Corporation. U.S. and Foreign Patents. For patents see <http://dts.com/patents>. HD Radio, Artist Experience, and the HD, HD Radio, and "ARC" logos are registered trademarks or trademarks of iBiquity Digital Corporation in the United States and/or other countries.

## MULTICAST

On the FM radio frequency most digital stations have additional programs on one FM station.

1. Select .
  - Each time  is selected, the channel can be changed.



## Digital Sound

- HD Radio™ Technology improves the audio quality of your local stations and delivers a crystal clear digital signal to your receiver. HD Radio Technology enables local radio stations to broadcast a clean digital signal. AM sounds like today's FM and FM sounds like clear digital.

## HD2/HD3

- FM stations can provide additional digital-only audio programming on HD2/HD3 Channels.
- EXAMPLE:  
101.1 HD1  
101.1 HD2  
101.1 HD3

## NOTE

- HD Radio™ stations can be preset.
- An orange  will be displayed on the screen when in digital. The  will first appear in a gray color indicating the digital station is being acquired. Once the digital signal is acquired, the logo will change to a bright orange color.
- The song title and artist name will appear on the screen when available by the radio station. The radio station can send album pictures when available.
- As a user works through the analog radio stations, (where applicable) the radio receiver will automatically tune from an analog signal to a digital signal within 5 seconds.

## Program Info

- Program info provides song name, artist, station ID, and other relevant data to your receiver.

## Artist Experience

- Visual images of album cover art and station logos are broadcasted with the audio to your receiver, such as Album Art, historical photographs, still art from live broadcasts, station logos, among other related content.

## Live Pause

- Allows HD Radio receivers to store content (songs/programs and data) in a buffer. Playback shall start at any point in the buffer and shall continue until the end of the buffer or until the user has selected to stop playback. Live Pause has the ability to store both analog and digital content in the buffer.



## CACHING RADIO PROGRAMS

A radio program can be cached and played back in a time-shifted manner.

### AUTOMATIC PLAYBACK OF THE CACHE

If the radio broadcast is interrupted by another audio output, such as an incoming phone call, the system will automatically cache the interrupted portion. To manually operate the cache operation: (→P.147)

#### NOTE

- The system can store up to 30 minutes. Cached data will be erased when the radio mode or station is changed or when the audio system is turned off.

## PLAYING BACK THE CACHE MANUALLY

The broadcast cached in the program cache can be played back manually.

1. Select **Replay** (Replay). (→P.143)

2. Select the desired cache radio operation button.

► **11.6-inch display system/11.6-inch display with Navi system**

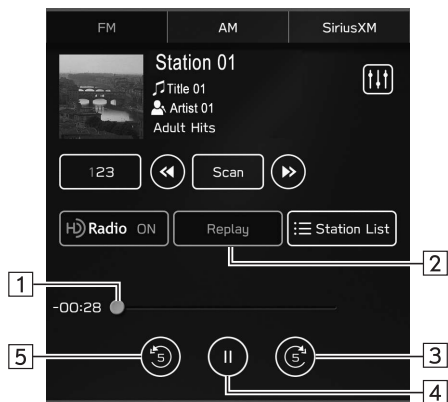

► **Dual 7.0-inch display system**

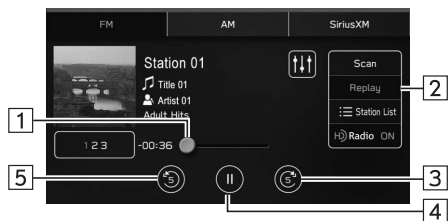

<b>1</b>	Shows the current playback location. The playback location can be changed by dragging the sliders.
<b>2</b>	Select to display the preset stations/channels. (→P.143)
<b>3</b>	Select: Skips forward 5 seconds. Select and hold: Fast forwards continuously.
<b>4</b>	Pauses or plays the radio broadcast.
<b>5</b>	Select: Skips backward 5 seconds. Select and hold: Fast rewinds continuously.

**NOTE**

● The time displayed on the bar scale may differ from the actual time.

# SiriusXM® Radio

## OVERVIEW

The SiriusXM® control screen can be accessed by selecting **SiriusXM** (SiriusXM) on the radio control screen. (→P.137)

### ► Control panel



<b>1</b>	Turn to adjust the volume. Press to mute the audio system. Press and hold to turn the audio system off, and press and hold to turn it on again.
<b>2</b>	Turn to step up/down channels. Press and hold to display the sound customization screen. (→P.138)

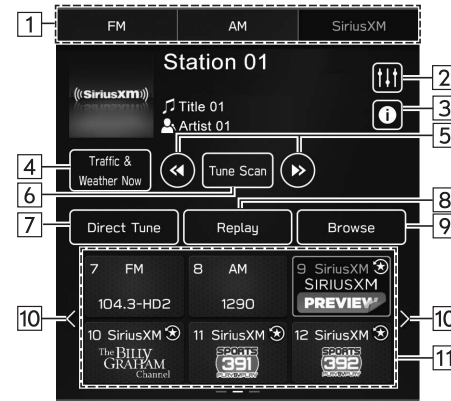

### ► Control screen

#### ► 11.6-inch display system/11.6-inch display with Navi system

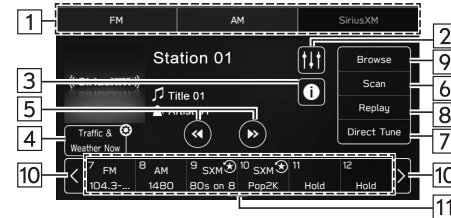

#### ► Dual 7.0-inch display system



1	Select to change radio modes.
2	Select to display the sound customization screen. (→P.138)
3	Select to display the channel information.
4	<p>: Select to listen to traffic and weather information for the set city.</p> <p>: Select to set the city for which you wish to hear traffic and weather information. (→P.93)</p>
5	Select to step up/down channels.
6	<p><b>Scan</b> (Scan): Select to search subscribed channels.</p> <p><b>Tune Scan</b> (Tune Scan): Select to search channels registered to Smart Favorites. This function can be enabled/disabled by the Tune Scan setting on the SiriusXM settings screen. (→P.93)</p>
7	Select to search channels by entering the channel number.
8	Select to display the cache radio operation buttons. (→P.153)
9	Select to search channels. (→P.155)
10	Select to scroll the list of preset buttons.
11	<p>Select to tune to preset stations/channels. The preset station list can be scrolled by swiping the list.</p> <p>: Indicates a channel which has been registered as a Smart Favorite. Up to 10 channels can be registered as Smart Favorites, in the order they are registered as a preset.</p>

**NOTE**

- Tune Scan is not designed for short tracks.

**HOW TO SUBSCRIBE TO SiriusXM® Radio**

To listen to a SiriusXM broadcast in the vehicle, a subscription to SiriusXM service is necessary following a free trial.

A SiriusXM® Radio is a tuner designed exclusively to receive broadcasts provided under a separate subscription.

The SXM service is only available in the U.S. and Canada.

## HOW TO SUBSCRIBE

SiriusXM audio services require a subscription sold separately, or as a package, by Sirius XM Radio Inc.

Subscription Details: Your SiriusXM service will automatically stop at the end of your trial unless you decide to purchase another subscription. If you decide to continue service, the paid subscription plan you choose will automatically renew thereafter, and you will be charged the rate in effect at that time and according to your chosen payment method. Fees and taxes may apply. All fees and programming are subject to change.

- For complete information on subscription rates, to review the SiriusXM Customer Agreement, or to subscribe to SiriusXM Radio please refer to the following:

### ► U.S.A.

Refer to [www.siriusxm.com](http://www.siriusxm.com) or call

**To Subscribe: 1-877-447-0011.**

**To Cancel: 1-866-635-2349.**

### ► Canada

Refer to [www.siriusxm.ca](http://www.siriusxm.ca) or call

**To Subscribe/Cancel: 1-877-209-0079.**

## ⚠ WARNING

- Explicit Language Notice — Channels with frequent explicit language are indicated with an “XL” preceding the channel name. Channel blocking is available for SiriusXM® Radio receivers by notifying SiriusXM at;

U.S.A. Customers:

Visit [www.siriusxm.com](http://www.siriusxm.com) or calling

1-877-447-0011

Canadian Customers:

Visit [www.siriusxm.ca](http://www.siriusxm.ca) or calling

1-877-209-0079

## ⚠ CAUTION

- It is prohibited to copy, decompile, disassemble, reverse engineer, hack, manipulate, or otherwise make available any technology or software incorporated in receivers compatible with the SiriusXM® Radio Services or that support the SiriusXM website, the Streaming Service or any of its content. Furthermore, the AMBE® voice compression software included in this product is protected by intellectual property rights including patent rights, copyrights, and trade secrets of Digital Voice Systems, Inc.
- Note: this applies to SiriusXM® Radio receivers only and not SiriusXM Ready devices.

## NOTE

### ● SiriusXM® Radio Services — Descriptions

#### ABOUT

#### SiriusXM Services

Most in-car trials today include SiriusXM's best package — All Access. It includes every channel available on your radio, plus streaming.

#### SiriusXM All Access

With the SiriusXM All Access package, you can enjoy over 150 channels including commercial-free music, plus sports, news, talk, comedy, entertainment and more inside your vehicle. Plus, streaming is included so you can listen 200+ channels online, on the app, and at home on a wide variety of connected devices, plus over 5,000 hours of On Demand shows, performances and interviews.

Did you know? SiriusXM also delivers a wide variety of services to certain vehicles' entertainment and navigation systems such as Traffic, Weather, Sports Scores, Movie Listings, Fuel Prices, Stock Prices and more. For a list of available features in your vehicle, visit [siriusxm.com/infotainment](http://siriusxm.com/infotainment) and get the most out of your driving experience.

## NOTE

### RADIO OPERATION

Look for the Sirius, XM, SXM, Band, SAT, AUX, Radio or Source button and you're in.

If you can't hear us, it's easy to get started:

- Locate your Radio ID/ESN by turning to Channel 0. If you don't see your number there, go to [Siriusxm.com/activationhelp](http://Siriusxm.com/activationhelp) to find it.
- Visit [siriusxm.com/refresh](http://siriusxm.com/refresh) or call 1-855-MYREFRESH (697-3373) to send a refresh signal to your radio.

Canadian Customers:

- Locate your Radio ID/ESN by turning to Channel 0.
- Visit [siriusxm.ca/refresh](http://siriusxm.ca/refresh) to send a refresh signal to your radio or call 1-888-539-7474 for service.

## DISPLAYING THE RADIO ID

Each SiriusXM tuner is identified with a unique radio ID which is 8 alphanumeric characters. The radio ID is required when activating SiriusXM Satellite Services or when reporting a problem.

The radio ID can be checked by tuning to channel "000".

## PRESETTING A CHANNEL

Multiple stations can be registered as presets.

1. Tune to the desired channel.
2. Select and hold one of the desired preset station buttons.
  - To change the preset station to a different one, follow the same procedure.

## CACHING RADIO PROGRAMS

A radio program can be cached and played back in a time-shifted manner.

The program that is currently being listened to can be cached.

---

### PLAYING BACK THE CACHE

---

The broadcast cached in the program cache can be played back.

1. Select **Replay** (Replay). (→P.149)

2. Select the desired cache radio operation button.

► 11.6-inch display system/11.6-inch display with Navi system

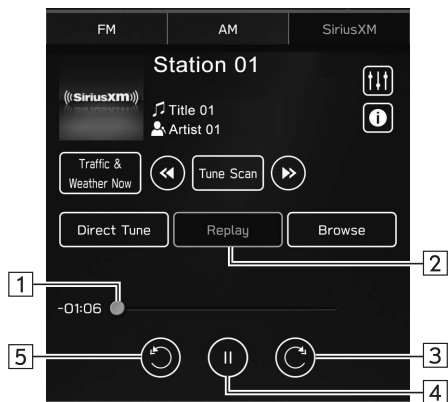

► Dual 7.0-inch display system



1	Shows the current playback location. The playback location can be changed by dragging the sliders.
2	Select to display the preset stations/channels. (→P.149)
3	Select: Access the desired program. Skips forward through program. Select and hold: Fast forwards continuously.
4	Pauses or plays the radio broadcast.
5	Select: Access the desired program. Skips back through program. Select and hold: Fast rewinds continuously.

**NOTE**

- The time displayed on the bar scale may differ from the actual time.



## SELECTING A CHANNEL FROM THE LIST

1. Select **Browse** (Browse).
2. Select the desired list, and then select the desired channel.

### ► 11.6-inch display system/11.6-inch display with Navi system



### ► Dual 7.0-inch display system



1	Select to display the all channels list.
2	Select to display categories channel list. (→P.155)
3	Select to set teams for notifying the user of games starting and SportsFlash. (→P.156)
4	Select to display the TuneMix channel. (→P.157)

## SELECTING FROM CATEGORIES CHANNEL LIST

1. Select **Categories** (Categories).
2. Select the desired genre.
3. Select the desired channel.

## SETTING TEAMS FOR NOTIFICATIONS

By registering teams, a pop-up screen appears notifying listeners of information on the game progress and so on. You can return to the original point in the regular broadcast by exiting the pop-up screen.

To use this function, turn “Sport Team Alert” on in SiriusXM settings screen. (→P.93)

---

### ADDING TEAMS

1. Select **Browse** (Browse).
2. → **Favorite Teams** (Favorite Teams)
3. → **Add** (Add)
4. Select the desired league.
5. Select the desired team.

---

### EDITING THE LIST

1. Select **Favorite Teams** (Favorite Teams).
2. → **Edit** (Edit)
3. Select  for the item you wish to delete.
4. → **OK** (OK)

---

### SETTING POP-UP ALERTS

Pop-up alerts can be set to display on the screen.

1. Select **Favorite Teams** (Favorite Teams).
2. Select  for the desired team.
3. Select the desired item to be set.
4. → **Save** (Save)

## SETTING TUNEMIX CHANNELS

If multiple channels for which TuneMix is possible have been registered as TuneMix channels, songs from these channels can be listened to randomly.

### REGISTERING CHANNELS

1. Select **Browse** (Browse).
2. → **TuneMix** (TuneMix)
3. → **Add** (Add)
4. Select the desired channels.

### LISTENING TO TUNEMIXED CHANNELS

1. Select the desired items on the “TuneMix” screen.

## EDITING THE TUNEMIX

1. Select **Edit** (Edit) on the “TuneMix” screen.
2. Select the desired item to be set.
  - : Select to delete the item.
3. → **OK** (OK)
4. Select the desired channels.

### NOTE

- The TuneMix name cannot be changed.

# MEDIA OPERATION

## CD (IF EQUIPPED WITH A CD PLAYER)

### OVERVIEW

The CD control screen can be accessed with the following methods:

- Insert a disc. (→P.65)
- Select **CD** (CD) on the media control screen. (→P.137)

#### ▶ Control panel



<b>1</b>	Turn to adjust the volume. Press to mute the audio system. Press and hold to turn the audio system off, and press and hold to turn it on again.
<b>2</b>	Turn to change the track. Press and hold to display the sound customization screen. (→P.138)

#### ▶ Control screen

##### ▶ 11.6-inch display system/11.6-inch display with Navi system

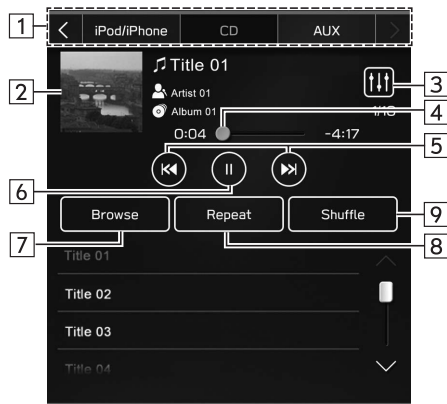

##### ▶ Dual 7.0-inch display system



1	Select to switch between other media sources.
2	Displays cover art.
3	Select to display the sound customization screen. (→P.138)
4	Shows progress. The playback location can be changed by dragging the sliders.
5	Select to change the track. Select and hold to fast forward/rewind.
6	Select to pause/play.
7	Select to search for a track.
8	Audio CDs: Changes between repeat all tracks → repeat current track → cancel repeat each time this button is selected. MP3/WMA/AAC discs: Changes between repeat current album/folder → repeat current track → cancel repeat each time this button is selected.
9	Select to enable/disable random playback for the tracks currently playing on the CD.

**NOTE**

- If a disc contains CD-DA files and MP3/WMA/AAC files, only the CD-DA files can be played back.
- If a CD-TEXT disc is inserted, the title of the disc and track will be displayed.
- Depending on the disc or music file being played, the cover art may not be displayed.

## USB MEMORY

Audio files on a USB memory device can be played back.

### OVERVIEW

The USB Audio playback screen can be accessed with the following methods:

- Connect a USB memory device. (→P.66)
- Select **USB** (USB) on the media control screen. (→P.137)

#### ▶ Control panel



<b>1</b>	Turn to adjust the volume. Press to mute the audio system. Press and hold to turn the audio system off, and press and hold to turn it on again.
<b>2</b>	Turn to change the track. Press and hold to display the sound customization screen. (→P.138)

#### ▶ Control screen

##### ▶ 11.6-inch display system/11.6-inch display with Navi system

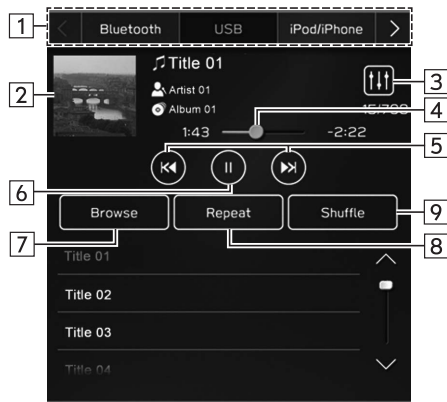

##### ▶ Dual 7.0-inch display system

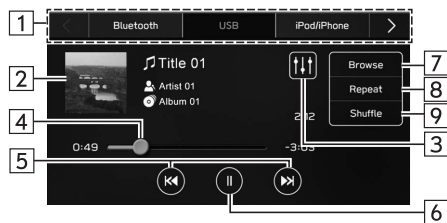

1	Select to switch between other media sources.
2	Displays cover art.
3	Select to display the sound customization screen. (→P.138)
4	Shows progress. The playback location can be changed by dragging the sliders.
5	Select to change the track. Select and hold to fast forward/rewind.
6	Select to pause/play.
7	Select to search for a track.
8	Changes between repeat current album/folder → repeat current track → cancel repeat each time this button is selected.
9	Select to enable/disable random playback for the tracks currently playing from the USB memory device.

### WARNING

- Do not operate the player's controls or connect the USB memory device while driving.

### CAUTION

- Do not leave your portable player in the vehicle. In particular, high temperatures inside the vehicle may damage the portable player.
- Do not push down on or apply unnecessary pressure to the portable player while it is connected as this may damage the portable player or its terminal.
- Do not insert foreign objects into the port as this may damage the portable player or its terminal.

### NOTE

- Depending on the device or music file being played, the cover art may not be displayed.
- If "SUBARU STARLINK Auto Connect" is on, audio files on a connected USB memory device cannot be played back. To playback audio files on a USB memory device, connect the USB memory device after turning "SUBARU STARLINK Auto Connect" off. (→P.83)

## iPod/iPhone

When an iPod/iPhone is connected, you can play iPod/iPhone music files. On this unit, you can perform operations such as selecting a file from a list or changing to the random playback mode.

### CONNECTING THE iPod/iPhone

1. Connect an iPod/iPhone to the USB port. (→P.66)
2. Check the confirmation message, and then select **No** (No).
  - If “Don’t show again.” is selected, the confirmation message will not be displayed again.
 If the connected iPhone is recognized as an Apple CarPlay device, select the device from the Apple CarPlay device list to remove the check mark. (→P.122)

### OVERVIEW

Select **iPod/iPhone** (iPod/iPhone) on the media control screen. (→P.137)

#### ► Control panel



<b>1</b>	Turn to adjust the volume. Press to mute the audio system. Press and hold to turn the audio system off, and press and hold to turn it on again.
<b>2</b>	Turn to change the track. Press and hold to display the sound customization screen. (→P.138)



▶ Control screen (When not connected as an Apple CarPlay device)

▶ 11.6-inch display system/11.6-inch display with Navi system

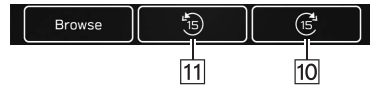
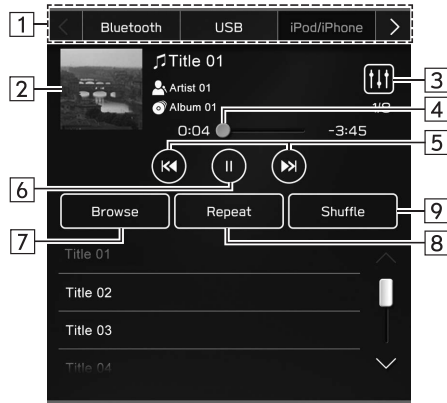

▶ Dual 7.0-inch display system

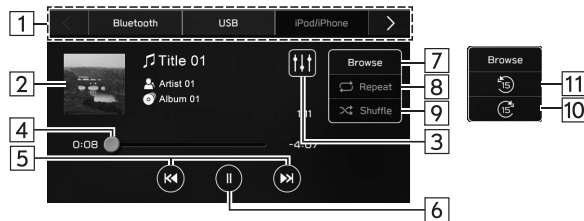

▶ Control screen (When connected as an Apple CarPlay device)

▶ 11.6-inch display system/11.6-inch display with Navi system

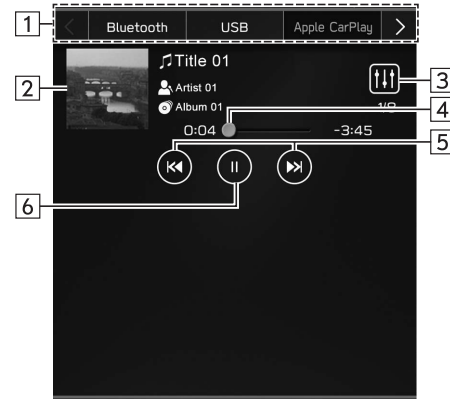

▶ Dual 7.0-inch display system



1	Select to switch between other media sources.
2	Displays cover art.
3	Select to display the sound customization screen. (→P.138)
4	Shows progress. The playback location can be changed by dragging the sliders.
5	Select to change the track. Select and hold to fast forward/rewind.
6	Select to pause/play.
7	Select to search for a track.
8	Changes between repeat current album → repeat current track → cancel repeat each time this button is selected.
9	Select to enable/disable random playback for the tracks currently playing on the iPod/iPhone.
10 *	Select to fast forward the current content item in fixed intervals.
11 *	Select to rewind the current content item in fixed intervals.

\*: Display when playing Audiobooks or Podcasts

### WARNING

- Do not operate the player's controls or connect the iPod/iPhone while driving.

### CAUTION

- Do not leave your portable player in the vehicle. In particular, high temperatures inside the vehicle may damage the portable player.
- Do not push down on or apply unnecessary pressure to the portable player while it is connected as this may damage the portable player or its terminal.
- Do not insert foreign objects into the port as this may damage the portable player or its terminal.

### NOTE

- When an iPod/iPhone is connected using an undamaged genuine iPod/iPhone cable, battery of the iPod/iPhone will be charged.
- When playing music on an iPod/iPhone, operate connect it to the system using an undamaged genuine iPod/iPhone cable and operate the iPod/iPhone from the system. Certain functions may not be available if connected using other methods. Furthermore, depending on the connected iPod/iPhone, certain functions may not be available.
- Depending on the iPod/iPhone or music file being played, the cover art may not be displayed.
- When an iPod/iPhone is connected and the audio source is changed to iPod/iPhone mode, the iPod/iPhone will resume playing from the same point it was last used.
- Tracks selected by operating a connected iPod/iPhone may not be recognized or displayed properly.

## Bluetooth AUDIO

The Bluetooth audio system enables users to play music files stored on Bluetooth devices through the vehicle speakers via wireless communication.

This audio system supports Bluetooth, a wireless data system capable of playing portable audio music without cables. If your device does not support Bluetooth, the Bluetooth audio system will not function.

### OVERVIEW

The Bluetooth audio control screen can be accessed by selecting **Bluetooth** (Bluetooth) on the media control screen. (→P.137)

Depending on the type of portable player connected, some functions may not be available and/or the screen may look differently than shown in this manual.

### ► Control panel



1	Turn to adjust the volume. Press to mute the audio system. Press and hold to turn the audio system off, and press and hold to turn it on again.
2	Turn to change the track. Press and hold to display the sound customization screen. (→P.138)

► **Control screen**

► **11.6-inch display system/11.6-inch display with Navi system**

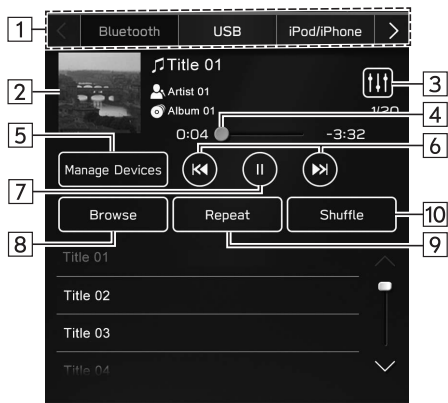

► **Dual 7.0-inch display system**

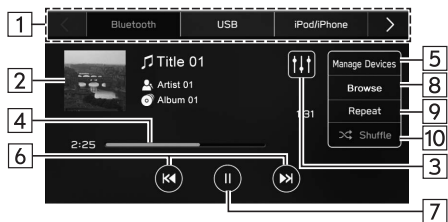

1	Select to switch between other media sources.
2	Displays cover art.
3	Select to display the sound customization screen. (→P.138)
4	Shows progress. The playback location can be changed by dragging the sliders.
5	Select to display the "Manage Devices" screen. (→P.168)
6	Select to change the track. Select and hold to fast forward/rewind.
7	Select to pause/play.
8	Select to search for a track.
9	Changes between repeat current album/folder → repeat current track → cancel repeat each time this button is selected.
10	Select to enable/disable random playback for the tracks currently playing on the Bluetooth device.



**⚠ WARNING**

- Do not operate the player's controls or connect to the Bluetooth audio system while driving.
- This system is fitted with Bluetooth antennas. People with implantable cardiac pacemakers, cardiac resynchronization therapy-pacemakers or implantable cardioverter defibrillators should maintain a reasonable distance between themselves and the Bluetooth antennas. The radio waves may affect the operation of such devices.
- Before using Bluetooth devices, users of any electrical medical device other than implantable cardiac pacemakers, cardiac resynchronization therapy-pacemakers or implantable cardioverter defibrillators should consult the manufacturer of the device for information about its operation under the influence of radio waves. Radio waves could have unexpected effects on the operation of such medical devices.

**⚠ CAUTION**

- Do not leave your portable player in the vehicle. In particular, high temperatures inside the vehicle may damage the portable player.

**NOTE**

- Depending on the Bluetooth device that is connected to the system, the music may start playing when selecting  while it is paused. Conversely, the music may pause when selecting  while it is playing.
- In the following conditions, the system may not function:
  - The Bluetooth device is turned off.
  - The Bluetooth device is not connected.
  - The Bluetooth device has a low battery.
- It may take time to connect the phone when Bluetooth audio is being played.
- For operating the portable player, see the instruction manual that comes with it.
- If the Bluetooth device is disconnected due to poor reception from the Bluetooth network when the ignition switch is turned to the "ACC" or "ON" position, the system will automatically reconnect to the portable player.
- If the Bluetooth device is disconnected on purpose, such as it was turned off, this does not happen. Reconnect the portable player manually.
- Bluetooth device information is registered when the Bluetooth device is connected to the Bluetooth audio system. When selling or disposing of the vehicle, remove the Bluetooth audio information from the system. (→P.83)
- Depending on the Bluetooth device or music file being played, the cover art may not be displayed.
- If the Bluetooth device does not play automatically when connected, device operation may be necessary.

## CONNECTING A Bluetooth DEVICE

To use the Bluetooth audio system, it is necessary to register a Bluetooth device with the system.

### ► Registering an additional device

1. Select **Manage Devices** (Manage Devices) on the Bluetooth audio control screen.
2. For more information: →P.78

### ► Selecting a registered device

1. Select **Manage Devices** (Manage Devices) on the Bluetooth audio control screen.
2. Select the Bluetooth device to be connected.

## AUX

### OVERVIEW

The AUX control screen can be accessed with the following methods:

- Connect a portable audio device. (→P.66)
- Select **AUX** (AUX) on the media control screen. (→P.137)

### ► Control panel



1	Turn to adjust the volume. Press to mute the audio system. Press and hold to turn the audio system off, and press and hold to turn it on again.
2	Press and hold to display the sound customization screen. (→P.138)

## ▶ Control screen

### ▶ 11.6-inch display system/11.6-inch display with Navi system



### ▶ Dual 7.0-inch display system



1

Select to switch between other media sources.

2

Select to display the sound customization screen. (→P.138)

### ⚠ WARNING

- Do not operate the player's controls or connect the portable audio device while driving.

### ⚠ CAUTION

- Do not leave portable audio device in the vehicle. The temperature inside the vehicle may become high, resulting in damage to the player.
- Do not push down on or apply unnecessary pressure to the portable audio device while it is connected as this may damage the portable audio device or its terminal.
- Do not insert foreign objects into the port as this may damage the portable audio device or its terminal.

## Android Auto\*

\*: When connected as an Android Auto device

Audio files on an Android Auto device can be played back.

### CONNECTING AN Android Auto DEVICE

1. Connect an Android Auto device to the USB port. (→P.66)
2. Check the confirmation message, and then select **Yes** (Yes).
  - If “Don’t show again.” is selected, the confirmation message will not be displayed again. If the connected Android device is not recognized as an Android Auto device, select the check box for the device on the Android Auto device list. (→P.125)

### OVERVIEW

Select **Android Auto** (Android Auto) on the media control screen. (→P.137)

#### ► Control panel



<b>1</b>	Turn to adjust the volume. Press to mute the audio system. Press and hold to turn the audio system off, and press and hold to turn it on again.
<b>2</b>	Turn to change the track. Press and hold to display the sound customization screen. (→P.138)



► Control screen

► 11.6-inch display system/11.6-inch display with Navi system

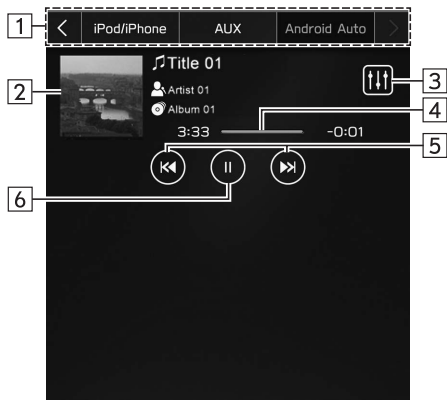

1	Select to switch between other media sources.
2	Displays cover art.
3	Select to display the sound customization screen. (→P.138)
4	Shows progress.
5	Select to change the track.
6	Select to pause/play.

► Dual 7.0-inch display system



**⚠ WARNING**

- Do not operate or connect an Android Auto device while driving.

**⚠ CAUTION**

- Do not leave your Android Auto device in the vehicle. In particular, high temperatures inside the vehicle may damage it.
- Do not push down on or apply unnecessary pressure to the connector area of the Android Auto device while it is connected as this may damage the device or its terminals.
- Do not insert foreign objects into the port as this may damage the device or its terminals.

**NOTE**

- Depending on the device or music file being played, the cover art may not be displayed.

## AUDIO REMOTE CONTROLS

## STEERING WHEEL CONTROLS

Some parts of the audio system can be controlled using the steering wheel controls.

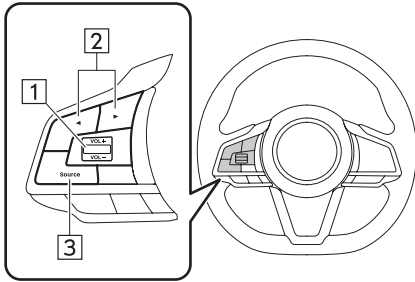

1	"VOL +/VOL -" switch
2	"</>" switch
3	"Source" switch

## ▶ "VOL +/VOL -" switch

Mode	Operation	Function
Volume	Press	Volume up/down
	Press and hold	Volume up/down continuously

## ▶ "◀/▶" switch

Mode	Operation	Function
AM/FM Radio, SiriusXM®	Press	Preset station/channel up/down
	Press and hold	Scan and stop at the first received station when the switch is released
Audio CD*, MP3/WMA/ AAC disc*, USB, iPod/iPhone, Bluetooth audio, Apple CarPlay	Press	Change a track/file
	Press and hold	Fast forward/rewind
Android Auto	Press	Change a track

\*: If equipped with a CD player

**▶ “Source” switch**

Mode	Operation	Function
All	Press	Turn on the audio system or change the audio source mode
	Press and hold	Turn off the audio system

**NOTE**

- In the SUBARU STARLINK mode, some operation may be done on the screen depend on the selected APPS.

**TIPS FOR OPERATING THE AUDIO SYSTEM****OPERATING INFORMATION** **CAUTION**

- To avoid damage to the audio system:
  - Be careful not to spill beverages over the audio system.
  - Do not put anything other than an appropriate disc into the disc slot.\*

\*: If equipped with a CD player

**NOTE**

- The use of a cellular phone inside or near the vehicle may cause a noise from the speakers of the audio system which you are listening to. However, this does not indicate a malfunction.

**RADIO**

Usually, a problem with radio reception does not mean there is a problem with the radio — it is just the normal result of conditions outside the vehicle.

For example, nearby buildings and terrain can interfere with FM reception. Power lines or phone wires can interfere with AM signals. And of course, radio signals have a limited range. The farther the vehicle is from a station, the weaker its signal will be. In addition, reception conditions change constantly as the vehicle moves.

Here, some common reception problems that probably do not indicate a problem with the radio are described.

---

**FM**

---

Fading and drifting stations: Generally, the effective range of FM is about 25 miles (40 km). Once outside this range, you may notice fading and drifting, which increase with the distance from the radio transmitter. They are often accompanied by distortion.

Multi-path: FM signals are reflective, making it possible for 2 signals to reach the vehicle's antenna at the same time. If this happens, the signals will cancel each other out, causing a momentary flutter or loss of reception.

Static and fluttering: These occur when signals are blocked by buildings, trees or other large objects. Increasing the bass level may reduce static and fluttering.

Station swapping: If the FM signal being listened to is interrupted or weakened, and there is another strong station nearby on the FM band, the radio may tune in the second station until the original signal can be picked up again.

---

**AM**

---

Fading: AM broadcasts are reflected by the upper atmosphere — especially at night. These reflected signals can interfere with those received directly from the radio station, causing the radio station to sound alternately strong and weak.

Station interference: When a reflected signal and a signal received directly from a radio station are very nearly the same frequency, they can interfere with each other, making it difficult to hear the broadcast.

Static: AM is easily affected by external sources of electrical noise, such as high tension power lines, lightening or electrical motors. This results in static.

---

**SiriusXM®**

---





- Cargo loaded on the roof luggage carrier, especially metal objects, may adversely affect the reception of SiriusXM® Radio.
- Alternation or modifications carried out without appropriate authorization may invalidate the user's right to operate the equipment.

## CD PLAYER AND DISC (IF EQUIPPED WITH A CD PLAYER)

- Extremely high temperatures can keep the CD player from working. On hot days, use the air conditioning system to cool the inside of the vehicle before using the player.
- Bumpy roads or other vibrations may make the CD player skip.
- If moisture gets into the CD player, the discs may not be able to be played. Remove the discs from the player and wait until it dries.

### WARNING

- CD players use an invisible laser beam which could cause hazardous radiation exposure if directed outside the unit. Be sure to operate the player correctly.

Audio CDs		
		

- Use only discs marked as shown above.
- This CD player is intended for use with 4.7 in. (12 cm) discs only.
- The following products may not be playable on your player:
  - SACD
  - dts CD
  - Copy-protected CD
  - Video CD

► **Special shaped discs**

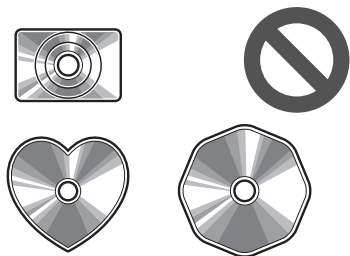

► **Transparent/translucent discs**

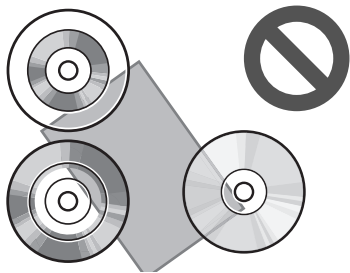

► **Low quality discs**

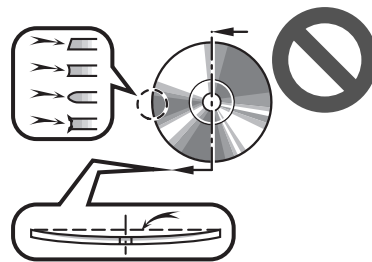

► **Labeled discs**

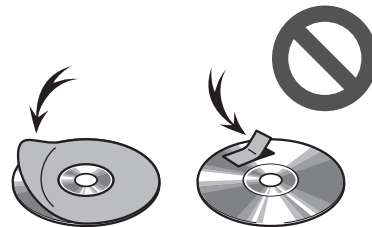



**CAUTION**

- Do not use special shaped, transparent/translucent, low quality or labeled discs such as those shown in the illustrations. The use of such discs may damage the player, or it may be impossible to eject the disc.
- This system is not designed for use of Dual Discs. Do not use Dual Discs because they may cause damage to the player.
- Do not use discs with a protection ring. The use of such discs may damage the player, or it may be impossible to eject the disc.
- Do not use printable discs. The use of such discs may damage the player, or it may be impossible to eject the disc.



Correct

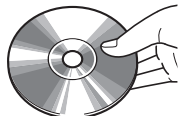

Wrong

- Handle discs carefully, especially when inserting them. Hold them on the edge and do not bend them. Avoid getting fingerprints on them, particularly on the shiny side.

- Dirt, scratches, warping, pin holes or other disc damage could cause the player to skip or to repeat a section of a track. (To see a pin hole, hold the disc up to the light.)
- Remove discs from the players when not in use. Store them in their plastic cases away from moisture, heat and direct sunlight.

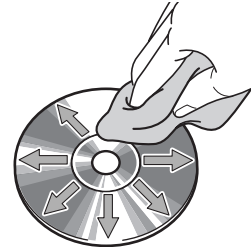

**To clean a disc:** Wipe it with a soft, lint-free cloth that has been dampened with water. Wipe in a straight line from the center to the edge of the disc (not in circles). Dry it with another soft, lint-free cloth. Do not use a conventional record cleaner or anti-static device.

## CD-R/RW DISCS

- CD-R/CD-RW discs that have not been subject to the “finalizing process” (a process that allows discs to be played on a conventional CD player) cannot be played.
- It may not be possible to play CD-R/CD-RW discs recorded on a music CD recorder or a personal computer because of disc characteristics, scratches or dirt on the disc, or dirt, condensation, etc. on the lens of the unit.
- It may not be possible to play discs recorded on a personal computer depending on the application settings and the environment. Record with the correct format. (For details, contact the appropriate application manufacturers of the applications.)
- CD-R/CD-RW discs may be damaged by direct exposure to sunlight, high temperatures or other storage conditions. The unit may be unable to play some damaged discs.
- If you insert a CD-RW disc into the player, playback will begin more slowly than with a conventional CD or CD-R disc.
- Recordings on CD-R/CD-RW cannot be played using the DDCD (Double Density CD) system.

## USB MEMORY DEVICE

- USB communication formats: USB 2.0 LS (1.5 Mbps)/FS (12 Mbps)/HS (480 Mbps)
- File formats: FAT 32
- Correspondence class: Mass storage class

## iPod/iPhone

The following iPod touch and iPhone devices can be used with this system.

Made for

- iPhone 11 Pro Max
- iPhone 11 Pro
- iPhone 11
- iPhone XS Max
- iPhone XS
- iPhone XR
- iPhone X
- iPhone 8 Plus
- iPhone 8
- iPhone 7 Plus
- iPhone 7
- iPhone SE
- iPhone 6s Plus
- iPhone 6s
- iPhone 6 Plus

- iPhone 6
- iPhone 5s
- iPhone 5c
- iPhone 5
- iPod touch (6th generation)
- For USA customers, please visit [www.subaru.com](http://www.subaru.com) for details. Outside of the USA customers, contact your local dealer to arrange a demonstration in order to confirm whether or not the phone can be paired with the vehicle.

## FILE INFORMATION

Codec	Description	Channels	Container/Extension
MPEG-4 AAC LC	8-48 kHz sampling rate 8-320 kbps CBR, VBR	Mono and stereo	.m4a, .aac
MPEG-4 HE AAC	16-48 kHz sampling rate 8-320 kbps CBR, VBR	Mono and stereo	.m4a, .aac
MPEG-4 HE AAC v2	16-48 kHz sampling rate 8-320 kbps CBR, VBR	Mono and stereo	.m4a, .aac
MP3	8-48 kHz sampling rate 8-320 kbps CBR, VBR	Mono, Stereo, and Joint	.mp3
WMA2/7/8/9/9.1/9.2	16-48 kHz sampling rate 8-320 kbps CBR, VBR	Mono and stereo	.wma
PCMWAVE	8 bit and 16 bit 8000, 16000, and 44100 Hz sampling frequency	Mono and stereo	.wav

Codec	Description	Channels	Container/Extension
FLAC	44.1 kHz, 48 kHz, 88.2 kHz, 96 kHz, 176.4 kHz, 192 kHz sampling rate 16 bit, 24 bit	Mono and stereo	.flac
ALAC	44.1 kHz, 48 kHz, 88.2 kHz, 96 kHz, 176.4 kHz, 192 kHz sampling rate 16 bit, 24 bit	Mono and stereo	.m4a

- The player is compatible with VBR (Variable Bit Rate).
- MP3 (MPEG Audio Layer 3), WMA (Windows Media Audio) and AAC (Advanced Audio Coding) are audio compression standards.
- This system can play AAC/AAC+ v2/MP3/WMA files on CD-R\*, CD-RW discs\*, USB memory device, and Bluetooth device.
  - \*: If equipped with a CD player
- This system can play disc recordings compatible with ISO 9660 level 1 and level 2 and with the Romeo and Joliet file system.\*
  - \*: If equipped with a CD player
- When naming an AAC/AAC+ v2/MP3/WMA file, add an appropriate file extension (.mp3/.wma/.m4a).
- This system plays back files with .mp3/.wma/.m4a file extensions as AAC/AAC+ v2/MP3/WMA files respectively. To prevent noise and playback errors, use the appropriate file extension.

- This system can play only the first session when using multi-session compatible CDs.\*  
\*: If equipped with a CD player
- MP3 files are compatible with the ID3 Tag Ver. 1.0, Ver. 1.1, Ver. 2.2 and Ver. 2.3 formats. This system cannot display disc title\* (folder name), track title\* (file name) and artist name in other formats.  
\*: If equipped with a CD player
- WMA/AAC files can contain a WMA/AAC tag that is used in the same way as an ID3 tag. WMA/AAC tags carry information such as track title\* (file name) and artist name.  
\*: If equipped with a CD player
- This system can play back AAC files encoded by iTunes.
- The sound quality of MP3/WMA files generally improves with higher bit rates. In order to achieve a reasonable level of sound quality, discs\* (USB memory device) recorded with a bit rate of at least 128 kbps are recommended.  
\*: If equipped with a CD player
- The MP3/WMA player does not play back MP3/WMA files from discs recorded using packet write data transfer (UDF format). Discs should be recorded using “pre-mastering” software rather than packet-write software.\*  
\*: If equipped with a CD player
- m3u playlists are not compatible with the audio device.
- MP3i (MP3 interactive) and MP3PRO formats are not compatible with the audio device.

- When playing back files recorded as VBR (Variable Bit Rate) files, the play time will not be correctly displayed if the fast forward or rewind operations are used.
- It is not possible to check folders that do not include AAC/AAC+ v2/MP3/WMA files.
- AAC/AAC+ v2/MP3/WMA files in folders up to 3 levels deep can be played. However, the start of playback may be delayed when using discs\* (USB memory device) containing numerous levels of folders. For this reason, we recommend creating discs\* (USB memory device) with no more than 2 levels of folders.  
\*: If equipped with a CD player

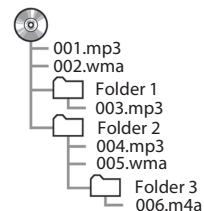

- The play order of the compact disc\* (USB memory device) with the structure shown above is as follows:

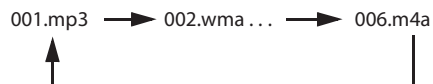

The play order will change according to the playback method.

\*: If equipped with a CD player

- The play order may change depending on the personal computer and AAC/AAC+ v2/MP3/WMA encoding software that were used.
- WMA (Windows Media Audio) is an audio compression format developed by Microsoft®. It compresses files into a size smaller than that of MP3 files. The decoding formats for WMA files are Ver. 7, 8 and 9. This product is protected by certain intellectual property rights of Microsoft Corporation and third parties. Use or distribution of such technology outside of this product is prohibited without a license from Microsoft or an authorized Microsoft subsidiary and third parties.
- MP3 is an audio compression standard determined by a working group (MPEG) of the ISO (International Standard Organization). MP3 compresses audio data to about 1/10 the size of that on conventional discs.



# Navigation System

## (If equipped)



<b>Basic Operation</b>	186
<b>Map Screen</b>	186
Map Screen Overview	186
<b>Map Screen Operation</b>	187
Current Position Display	187
Map Scale	188
Location Menu Pop-up	188
Orientation Of The Map	189
<b>Map Screen Information</b>	191
Gas Station/Parking Lot/Rest Area Icons	191
Traffic Information	191
Other Information	192
<b>Main Menu Screen</b>	193
Main Menu Screen Overview	193
Search Screen	195
Current Route Screen	196
Favorites Screen	198
Edit List Screen	200

<b>Route Calculation</b>	201
Route Calculation Screen	201
<b>Route Guidance</b>	203
<b>Route Guidance</b>	203
Route Guidance Screen	203
Standard Map Icon	205
<b>Typical Voice Guidance Prompts</b>	206
<b>Setup</b>	207
<b>Navigation Settings</b>	207
Navigation Settings Screen	207

<b>Tips For The Navigation System</b>	209
<b>GPS (Global Positioning System)</b>	209
Regarding Errors In Current Position Display	209
Limitations Of The Navigation System	209
<b>Map Data</b>	212
Regarding Roads And Place Name Data	212
SUBARU Map Update	212
Updating The Map Data Manually	
Using A USB Memory Device	213
Updating The Map Data Manually	
Using Wi-Fi®	213
Updating The Map Data Automatically	
Using Wi-Fi®	214
Updating The Map Data Manually	
Using A Smartphone	214

## BASIC OPERATION



## MAP SCREEN

## MAP SCREEN OVERVIEW

The map screen can be displayed using the following method:

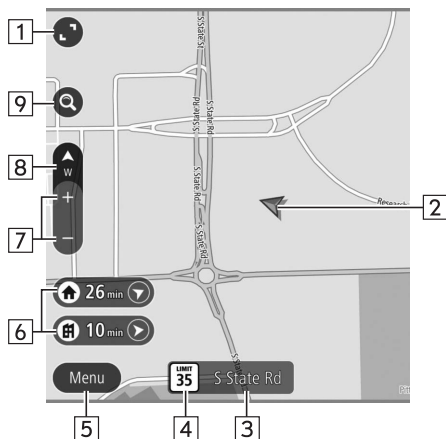
1. Display the home screen. (→P.40)
2. Select **Map** (Map).





1	Select to increase/reduce the size of the map screen. If the map is moved, this button will change to  .
2	Displays the current vehicle position.
3	Displays the current street name. <b>Add to Favorites</b> (Add to Favorites): Select to register your current location as a favorite. <b>Avoid Blocked Road</b> (Avoid Blocked Road): Select to display the alternate route screen and search for 2 additional routes to the selected destination. (→P.197)
4	Displays the speed limit for the road currently being travelled on.
5	Select to display the main menu screen.
6	By registering your home or work (→P.200), the direction and time required are displayed. Select  to set home as the destination. Select  to set work as the destination.
7	Select to change the scale of the map screen.



8	Select to change the map display mode between 2D north-up, 2D heading-up, or 3D heading-up. (→P.189)
9	Select to display the search screen.

## MAP SCREEN OPERATION

### CURRENT POSITION DISPLAY

After moving the map,  may be displayed. Select  to return the map to the current position.

#### NOTE

- While driving, the current position mark is fixed on the screen and the map moves.
- The current position is automatically set as the vehicle receives signals from the GPS (Global Positioning System). If the current position is not correct, it is automatically corrected after the vehicle receives signals from the GPS.
- If the battery has been disconnected or when the vehicle is new, the current position may not be correct. As soon as the system receives signals from the GPS, the correct current position will be displayed.
- The map screen can not be moved on the 3D heading-up mode.
- After moving the map, if it is not moved for a certain amount of time, it will automatically return to the current position.

## MAP SCALE

1. Select **+** or **-** to change the scale of the map screen.
  - When the automatic zoom function is on (→P.207) during route guidance, the map is zoomed in automatically when approaching intersections or turning points.

### NOTE

- The scale of the map screen can also be changed with the double touch or pinch operation. (→P.66)
- If the map scale has been changed after moving the map, the map scale will return to previous scale when the map is returned to the current position.
- The automatic zoom function may not operate if the map scale is adjusted manually during route guidance. To reenale the automatic zoom function, change the orientation of the map screen. (→P.189)

## LOCATION MENU POP-UP

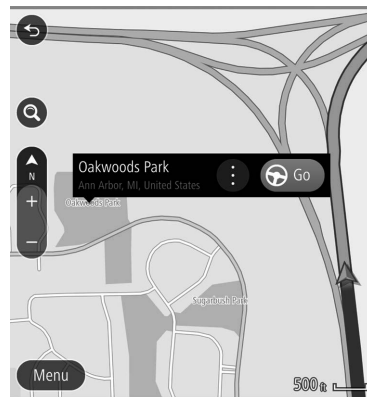

The location menu pop-up can be displayed using the following methods:

- Select and hold any point on the map.
- Select a point from a list.
- Select a POI icon.



Select **Go** (Go) to search for a route to the selected point and display the route calculation screen. (→P.201)

Select  to display the following options.

<b>Add to Favorites</b> (Add to Favorites)	Select to register the selected point as a favorite.
<b>Add to Current Route</b> (Add to Current Route)	Select to add the selected point as a waypoint on the current route.
<b>Search Near Here</b> (Search Near Here)	Select to display the search screen and search near the selected point. (→P.195)
<b>More Information</b> (More Information)	Select to display detailed information about the selected point.  : Select to call the registered phone number.  : Select to search for a route to the selected point and display the route calculation screen. (→P.201)
<b>Edit Location</b> (Edit Location)	Select to edit the point registered as home/work.
<b>Remove Location</b> (Remove Location)	Select to erase the point registered as home/work.
<b>Rename</b> (Rename)	Select to change the name of a registered favorite.

## ORIENTATION OF THE MAP

The orientation of the map can be changed between 2D north-up, 2D heading-up, and 3D heading-up.

1. Select .
  - Each time the symbol is selected, the orientation of the map changes.
  - The direction of this symbol indicates north.

### ▶ 2D north-up



- Regardless of the direction of vehicle travel, north is always up.
- The letter(s) indicate the direction in which the vehicle is heading (e.g. W for west).

► 2D heading-up

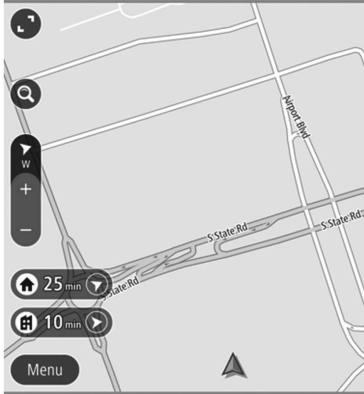

- The direction of vehicle travel is always up.

► 3D heading-up



- The direction of vehicle travel is always up.

## MAP SCREEN INFORMATION

### GAS STATION/PARKING LOT/REST AREA ICONS

Gas stations, parking lots and rest areas can be displayed on the route. Their location can also be set as a destination.

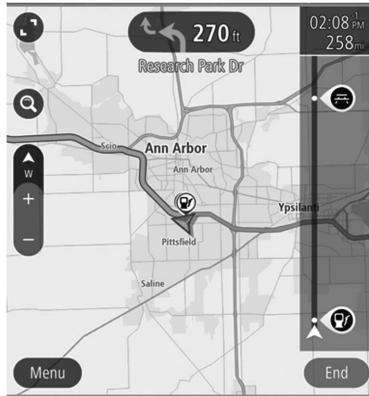

- The display of gas station/parking lots/rest area icons can be turned on/off. (→P.207)

### TRAFFIC INFORMATION

Road sections affected by traffic conditions are displayed in a different color on the map, and a small icon representing the type of traffic condition is displayed above the road.

This feature is available at certain map scales.

To receive the data service information in the vehicle, a subscription to the SiriusXM® Radio Service is necessary following a free trial. (→P.150)

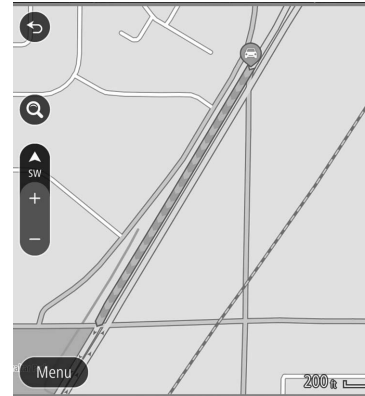

## OTHER INFORMATION

A pop-up screen will be displayed based on the driving situation, etc.

### ► Low fuel warning

When the fuel level is low, a warning message will pop up on the screen.

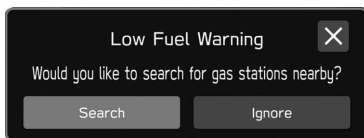

- **Search** (Search): Select to search for gas stations.
- **Ignore** (Ignore): Select to delete the message.

### ► Periodic rest notification

If the system determines, based on the driver's condition, that a rest may be necessary, a pop-up message will be displayed on the screen.

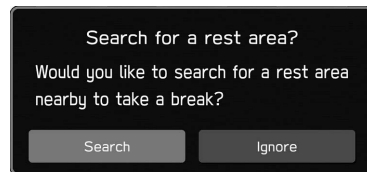

- **Search** (Search): Select to search for rest areas.
- **Ignore** (Ignore): Select to delete the message.
- Pop-up screens can be turned on/off using the "Periodic Rest Notification" setting on the general settings screen. (→P.83)

## MAIN MENU SCREEN

### MAIN MENU SCREEN OVERVIEW

The main menu screen can be displayed using the following method:

1. Display the map screen. (→P.186)
2. Select **Menu** (Menu).

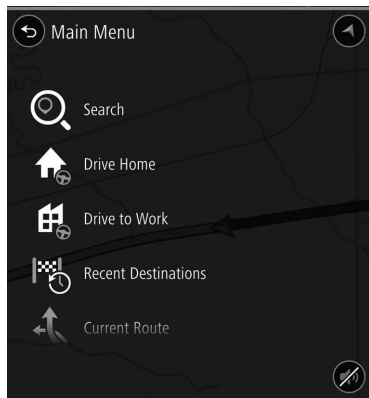

<b>Search</b> (Search)	Select to display the search screen. (→P.195)
<b>Add Home</b> (Add Home)*1/ <b>Drive Home</b> (Drive Home)*2	<b>Add Home</b> (Add Home): Select to register a point as home. (→P.200) <b>Drive Home</b> (Drive Home): Select to set the point registered as home as the destination.
<b>Drive to Work</b> (Drive to Work)*3	<b>Drive to Work</b> (Drive to Work): Select to set the point registered as work as the destination.
<b>Recent Destinations</b> (Recent Destinations)	Select to display the recent destination screen. Recent destinations: Select a recent destination to display the location menu pop-up for that point on the map screen. (→P.188) <b>Edit List</b> (Edit List): Select to display the edit list screen. (→P.200)
<b>Current Route</b> (Current Route)*4	Select to display the current route edit screen. (→P.196)
<b>Favorites</b> (Favorites)	Select to display the favorite screen. (→P.198)

<p><b>My Routes</b> (My Routes)<sup>*5</sup></p>	<p>Select to name the current route and register it so that it can be used repeatedly. (→P.196) My route name: Select a registered route to display it on the map screen. Select <b>Drive</b> (Drive) to display the route calculation screen. <b>Edit List</b> (Edit List): Select to display the edit list screen. (→P.200)</p>
<p><b>Points of Interest</b> (Points of Interest)</p>	<p>Select to display the Points of Interest screen. Select a category to display a list of related points. Select a point from the list to display the location menu pop-up for that point on the map screen. (→P.188) • To refine the list, select <b>Show Subcategories</b> (Show Subcategories).</p>
<p><b>Parking lot</b> (Parking lot)</p>	<p>Select to display parking lot icons on the map screen near your current location. Select a displayed icon to display the location menu pop-up. (→P.188)</p>
<p><b>Gas Station</b> (Gas Station)</p>	<p>Select to display gas station icons on the map screen near your current location. Select a displayed icon to display the location menu pop-up. (→P.188)</p>
<p><b>Maps</b> (Maps)</p>	<p>Select to display the map update screen. (→P.213)</p>

**Legal Information**

(Legal Information)

Select to display the legal information screen.

- \*1: If a point has not been registered as home.
- \*2: If a point has been registered as home.
- \*3: If a point has been registered as work.
- \*4: This item can only be selected when a route is set.
- \*5: This item can only be selected when a route has been registered to My Routes.



## SEARCH SCREEN

The destination can be set by typing an address or category (Points of Interest).



1	Select to set the radius filter. Once the radius filter has been set, a search will only be performed for items within that radius.
2	Select to display the current vehicle position.

3	<p>Select to change the search type.</p> <p><b>Addresses</b> (Addresses): Search for an address by inputting related words.</p> <p><b>Points of Interest</b> (Points of Interest): Search for a Points of Interest by inputting related words.</p>
4	<p>Some candidate destinations are displayed based on the input characters. The location menu pop-up is displayed on the map screen when an item is selected. (→P.188)</p> <p>If a non-specific point is selected, such as a street name, the following items will be displayed.</p> <p><b>Show on Map</b> (Show on Map): Select to display the location menu pop-up on the map screen. (→P.188)</p> <p><b>Add Crossroad</b> (Add Crossroad): Select to select an intersecting road and further refine the results.</p> <p><b>Drive</b> (Drive): Select to search for a route to the selected destination.</p>
5	Each time the button is selected, select to display/hide the keyboard.
6	Select to display the search map screen.
7	Select to display the search list screen.



## CURRENT ROUTE SCREEN

The current route screen can be displayed using the following method:

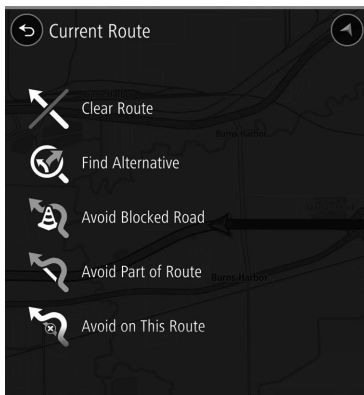
1. Display the map screen. (→P.186)
2. Select **Menu** (Menu).
3. → **Current Route** (Current Route)
  - **Current Route** (Current Route) can only be selected when a route is set.



<b>Clear Route</b> (Clear Route)	Select to stop the route guidance.
<b>Find Alternative</b> (Find Alternative)	Select to display the alternate route screen and search for 2 additional routes to the selected destination. (→P.197)
<b>Avoid Blocked Road</b> (Avoid Blocked Road)	Select to display the alternate route screen and search for 2 additional routes which avoid the current road. (→P.197)
<b>Avoid Part of Route</b> (Avoid Part of Route)	Select to display a list of sections of the current route. Select the section you wish to avoid and then select  to search for a new route.
<b>Avoid on This Route</b> (Avoid on This Route)	Select to change the avoidance criteria for the current route and search for a different route. (→P.201) This item can only be selected when the current route has a section which is included in the avoidance criteria.
<b>Show Instructions</b> (Show Instructions)	Select to display the route details confirmation screen.

<b>Add Stop to Route</b>	Select to search for a waypoint on the map or search screen (→P.195) and then select  to add it to the current route. (→P.201)
<b>Add to My Routes</b>	Select to name the current route and register it to My Routes.
<b>Change Route Type</b>	Select to change the route type of the current route and search for a new route. (→P.201)
<b>Reorder Stops</b>	Select to change the order of the currently set destination and waypoints. Select a destination, select  or  to change its position in the list, and then select <b>Done</b> (Done) to confirm the change. <b>Edit Stops</b> (Edit Stops): Select to display the edit list screen. (→P.200)
<b>Play Route Preview</b>	Select to turn route preview mode on/off. (→P.198)
<b>Stop Route Preview</b>	

## SELECTING AN ALTERNATE ROUTE

When the search for an alternate route is complete, the following screen will be displayed.

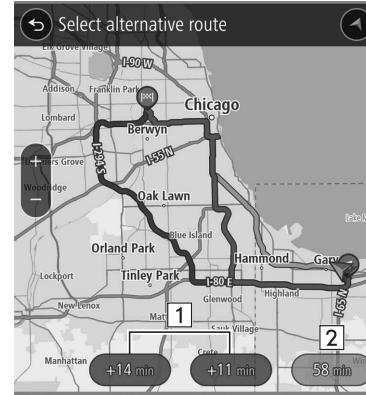

1	Displays the difference in travel time between the current route and an alternate route. Select to display the route confirmation screen for the selected route. (→P.201)
2	Current route travel time

## PREVIEWING THE ROUTE

A selected route can be previewed.

The speed of the preview can be changed.

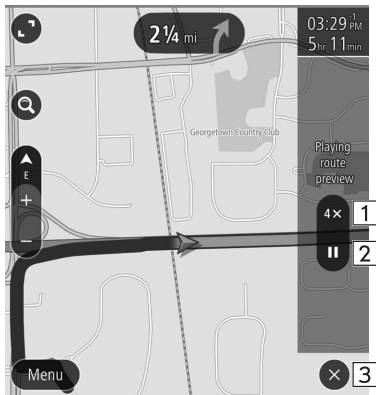

1	Select to change the preview speed to "1X"/"2X"/"4X".
2	Select to temporarily stop the preview.
3	Select to exit route preview mode.

## FAVORITES SCREEN

The desired point can be registered as home, work, or favorite.





The registered points can be set as a destination.

Registered points can be added, changed and deleted on the favorites screen.

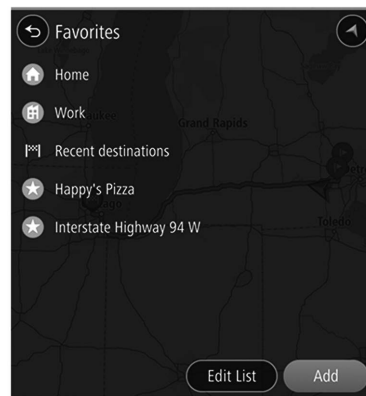
The favorites screen can be accessed with the following methods:

1. Display the map screen. (→P:186)
2. Select **Menu** (Menu).
3. → **Favorites** (Favorites)







	<p><b>Add Home</b> (Add Home): Select to register the home. (→P.200)</p> <p><b>Home</b> (Home): Select to display the location menu pop-up for the point registered as home on the map screen. (→P. 188)</p>
	<p><b>Add Work</b> (Add Work): Select to register the work. (→P.200)</p> <p><b>Work</b> (Work): Select to display the location menu pop-up for the point registered as work on the map screen. (→P. 188)</p>
	<p>Select to display the recent destination screen. Recent destinations: Select a recent destination to display the location menu pop-up for that point on the map screen. (→P. 188)</p> <p><b>Edit List</b> (Edit List): Select to display the edit list screen to delete the recent destinations. (→P.200)</p>
	<p>Select a favorite to display the location menu pop-up for that point on the map screen. (→P. 188)</p>

<p><b>Edit List</b> (Edit List)</p>	<p>Select to display the edit list screen to delete the favorites. (→P.200)</p>
<p><b>Add</b> (Add)</p>	<p>Select to register the favorite. (→P.200)</p>

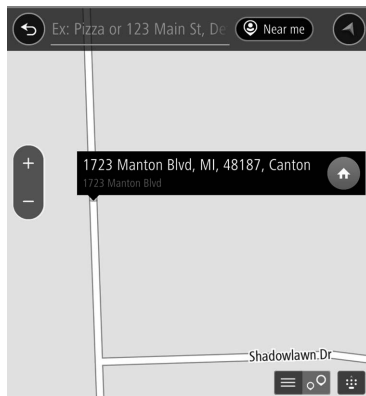
## REGISTERING HOME/WORK/FAVORITE POINT

1. Select **Add Home** (Add Home)/ **Add Work** (Add Work)/ **Add** (Add).
2. Perform either of the following to display a point you wish to register:
  - Select **Search** (Search) to display the search screen. (→P.195)
  - Select the desired point on the map.



3. →  /  / 
  - Icons will be displayed on the map to indicate registered points.

## EDIT LIST SCREEN

Unnecessary items can be deleted on the edit list screen.



1	Select <input type="radio"/> for the item you wish to delete.
2	Select to skip to the next or previous page.
3	Select to delete selected item(s).
4	Select to select all items. Select again to deselect all items.

# ROUTE CALCULATION

## ROUTE CALCULATION SCREEN

After searching for the destination, the route calculation screen will be displayed.

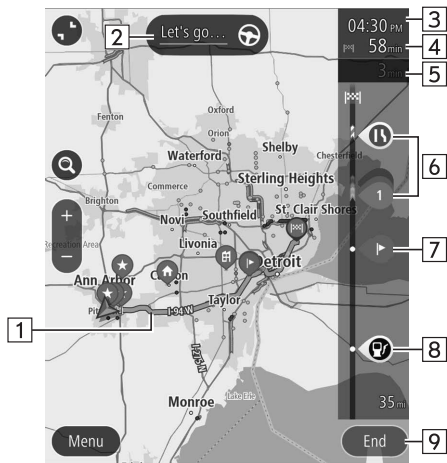

1	Displays the route overview.
2	Select to start route guidance.

3	<p>Estimated time of arrival</p> <p>Select to change the displayed information between a waypoint and the destination.</p> <ul style="list-style-type: none"> <li>• Select and hold to turn display of the route bar on/off.</li> <li>• If "Auto-Hide Route Bar" on the navigation settings screen is turned on, the route bar will automatically be hidden and will only be displayed when new route information is available.</li> </ul>
4	<p>Remaining distance and/or remaining time</p> <p>The displayed details can be changed on the navigation settings screen. (→P.207)</p>
5	Displays the change in travel time.
6	<p>Traffic information icon</p> <p>Select to display the traffic information pop-up.</p> <p><b>Avoid</b> (Avoid): Select to avoid a section of the current route based on traffic information.</p> <p><b>More Information</b> (More Information): Select to display detailed information for the selected traffic information.</p>
7	<p>Select to display the waypoint information pop-up.</p> <p><b>Delete This Stop</b> (Delete This Stop): Select to delete the selected waypoint from the route.</p>
8	<p>Displays a POI on the route.</p> <p>Select a displayed icon to display the location menu pop-up. (→P.188)</p>
9	Select to cancel route confirmation.

 **WARNING**

- Be sure to obey traffic regulations and keep road conditions in mind while driving. If a traffic sign on the road has been changed, the route guidance may not indicate such changed information.

**NOTE**

- The route for returning may not be the same as that for going.
- The route guidance to the destination may not be the shortest route or a route without traffic congestion.
- Route guidance may not be available if there is no road data for the specified location.
- If a destination that is not located on a road is set, the vehicle will be guided to the point on a road nearest to the destination. The road nearest to the selected point is set as the destination.



## ROUTE GUIDANCE

## ROUTE GUIDANCE

## ROUTE GUIDANCE SCREEN

During route guidance, various types of guidance screens can be displayed depending on conditions.

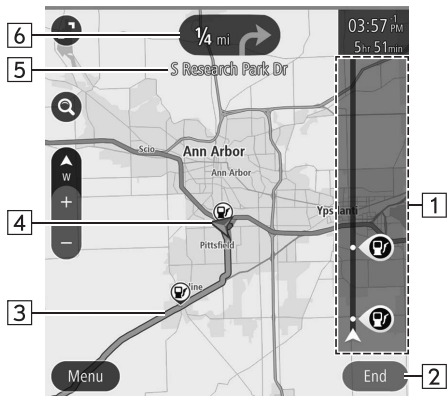

1	Route bar (→P.201)
2	Select to stopping route guidance.
3	Guidance route Select to display the current route menu pop-up. (→P. 196)
4	Current position
5	Next street name
6	Distance to the next turn and an arrow indicating the turning direction. Select to display the route event list screen.

### ► Junction screen

When approaching an expressway exit or a complicated intersection, the map switches to a 3D display if the necessary information can be displayed. An arrow indicates the lane in which you should drive. Signs are also displayed if the information is available.



- This function can be turned on/off on the navigation settings screen. (→P.207)

### ► Lane recommendation screen

When approaching a turning point, the lane recommendation will be displayed automatically.



Arrows will be displayed consecutively if necessary to turn again immediately after a turn.

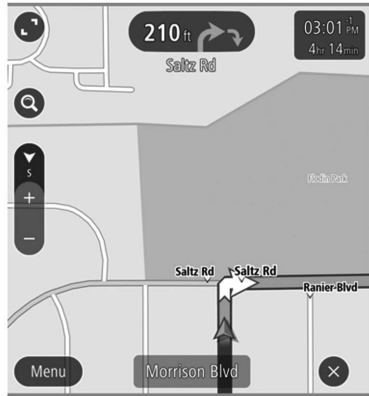



## NOTE

- If the vehicle goes off the guidance route, the route is searched again.
- For some areas, the roads have not been completely digitized in our database. For this reason, the route guidance may select a road that should not be traveled on.

## STANDARD MAP ICON

The following table shows the most frequently displayed route events.

	Turn left/right
	U-turn
	Keep left/right at the fork in the road.
	Turn left/right & sharp curve.
	Stay in the left/right lane.
	Go straight ahead at the intersection.
	Exit the junction
	Roundabout
	You have arrived at your destination.
	You have arrived at your waypoint.

	Toll road
	Freeway
	Ferry trip

## TYPICAL VOICE GUIDANCE PROMPTS

As the vehicle approaches an intersection, or point, where maneuvering the vehicle is necessary, the system's voice guidance will provide various messages.

### WARNING

- Be sure to obey the traffic regulations and keep the road condition in mind, especially when driving on IPD roads (roads that are not completely included in the map database). The route guidance may not have the most up-to-date information, such as the direction of a one way street.

### NOTE

- To adjust the voice guidance volume: →P.90
- Voice guidance may be made early or late.
- If the system cannot determine the current position correctly, you may not hear voice guidance or may not see the magnified intersection on the screen.

## SETUP

## NAVIGATION SETTINGS

1. Display the home screen. (→P.40)
2. Select **Settings** (Settings).
3. → **Navigation** (Navigation)
4. Select the desired item to be set.

## NAVIGATION SETTINGS SCREEN

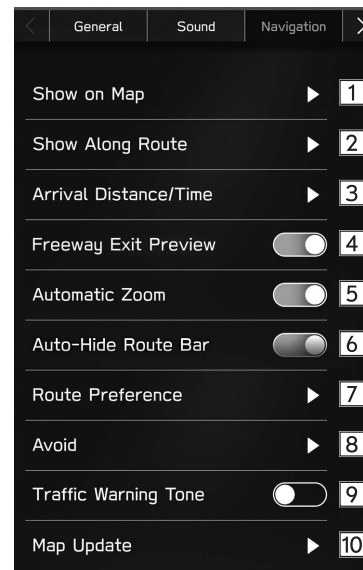

1	POI icons can be displayed on the map screen when “Show POI Icons on Map” is turned on and up to 5 POI icon types have been selected.
2	Select to turn the display for parking lots, gas stations and rest areas on/off for the route being travelled during route guidance.
3	Select to set the displays for the estimated remaining distance and estimated remaining time to the destination. (→P.201)
4	Select to turn the freeway exit preview on/off.
5	Select to set whether to automatically enlarge the map when approaching intersections or turning points during route guidance.
6	Select to turn the route bar auto-hide function on/off. (→P.201)
7	Select to change the preferred route type when searching for a new route.
8	Select to set avoidance criteria for the route calculation.
9	Select to turn the traffic alert sound on/off.
10	Select to set the updating of map data. (→P.212)

## TIPS FOR THE NAVIGATION SYSTEM

## GPS (GLOBAL POSITIONING SYSTEM)

### REGARDING ERRORS IN CURRENT POSITION DISPLAY

The system displays the vehicle current position based on GPS information and data from various sensors and road maps. However, when the radiowave signals from GPS satellites are weak or when signals are received from only two satellites or less, errors may occur in the position. Modifying or adjusting the system will not prevent these errors.

### LIMITATIONS OF THE NAVIGATION SYSTEM

This navigation system calculates the current position using satellite signals, various vehicle signals, map data, etc. However, an accurate position may not be shown depending on satellite conditions, road configuration, vehicle condition or other circumstances.

The Global Positioning System (GPS) developed and operated by the U.S. Department of Defense provides an accurate current position, normally using 4 or more satellites, and in some case 3 satellites. The GPS system has a certain level of inaccuracy. While the navigation system compensates for this most of the time, occasional positioning errors of up to 300 feet (100 m) can and should be expected. Generally, position errors will be corrected within a few seconds.

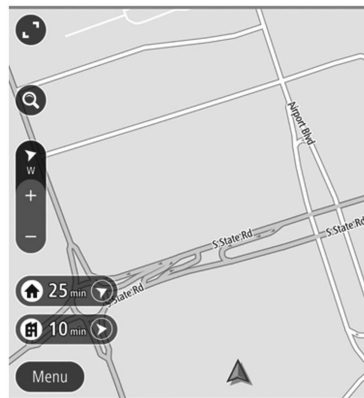

The GPS signal may be physically obstructed, leading to inaccurate vehicle position on the map screen. Tunnels, tall buildings, trucks, or even the placement of objects on the instrument panel may obstruct the GPS signals.

The GPS satellites may not send signals due to repairs or improvements being made to them.

Even when the navigation system is receiving clear GPS signals, the vehicle position may not be shown accurately or inappropriate route guidance may occur in some cases.

 **CAUTION**

- The installation of window tinting may obstruct the GPS signals. Most window tinting contains some metallic content that will interfere with GPS signal reception of the antenna in the instrument panel. We advise against the use of window tinting on vehicles equipped with navigation systems.
- Accurate current position may not be shown in the following cases:
  - When driving on a small angled Y-shaped road.
  - When driving on a winding road.
  - When driving on a slippery road such as in sand, gravel, snow, etc.
  - When driving on a long straight road.
  - When freeway and surface streets run in parallel.
  - After moving by ferry or vehicle carrier.
  - When a long route is searched during high speed driving.
  - After repeating a change of direction by going forward and backward, or turning on a turntable in a parking lot.
- When leaving a covered parking lot or parking garage.
- When a roof carrier is installed.
- When driving with tire chains installed.
- When the tires are worn.
- After replacing a tire or tires.
- When using tires that are smaller or larger than the factory specifications.
- When the tire pressure in any of the 4 tires is not correct.
- Inappropriate route guidance may occur in the following cases:
  - When turning at an intersection off the designated route guidance.
  - If you set more than 1 destination but skip any of them, auto reroute will display a route returning to the destination on the previous route.
  - When turning at an intersection for which there is no route guidance.
  - When passing through an intersection for which there is no route guidance.
  - During auto reroute, the route guidance may not be available for the next turn to the right or left.
  - During high speed driving, it may take a long time for auto reroute to operate. In auto reroute, a detour route may be shown.



- After auto reroute, the route may not be changed.
- If an unnecessary U-turn is shown or announced.
- If a location has multiple names and the system announces 1 or more of them.
- When a route cannot be searched.
- If the route to your destination includes gravel, unpaved roads or alleys, the route guidance may not be shown.
- Your destination point might be shown on the opposite side of the street.
- When a portion of the route has regulations prohibiting the entry of the vehicle that vary by time or season or other reasons.
- The road and map data stored in the navigation system may not be complete or may not be the latest version.

## NOTE

- This navigation system uses tire turning data and is designed to work with factory-specified tires for the vehicle. Installing tires that are larger or smaller than the originally equipped diameter may cause inaccurate display of the current position. The tire pressure also affects the diameter of the tires, so make sure that the tire pressure of all 4 tires is correct.

## MAP DATA

### REGARDING ROADS AND PLACE NAME DATA

When maps are created, land surveys are conducted and information on road improvements and reopening is collected to provide the most accurate information possible. However, modifications to roads, place names and facilities may be carried out at any time. Consequently, we cannot guarantee that map data contains no errors in road positions, configuration and names, or in facility names.

### SUBARU MAP UPDATE

Map data can be updated using the following methods:

- USB memory: All map data can be updated at once. →P.213
- Wi-Fi®: Individual regions can be selected and their map data updated.\* →P.214
- Smartphone: Individual regions can be selected and their map data updated. This method is for when the map update data is to be downloaded to a smartphone from outside of the vehicle, such as at home, and then transferred to the system. →P.214

\*: Up to 8 regions can be selected for the automatic update function.

## NOTE

- Map update using Wi-Fi® or a smartphone may not be available in some countries.
- For the best possible navigation experience, regularly update maps for all frequented regions, including nearby states. Failure to update maps for surrounding states may result in inaccurate map information during interstate travel. Updates made using a USB memory device will update map information for all states. Please visit Subaru.com for more information and the latest updates.
- If the map update fails or cannot be performed when using Wi-Fi® or a connected smartphone, check the communication status of the connected device. If there is a problem with communication, perform the procedure again using a different Wi-Fi® access point or smartphone.
- If the map update procedure fails, refer to the “TROUBLESHOOTING” section. (→P.240)
- Subaru may terminate or suspend your access to all or part of these services for any or no reason, including without limitation, any violation of the terms detailed at:  
<https://subaru-maps.com/#/termsofuse>

## UPDATING THE MAP DATA MANUALLY USING A USB MEMORY DEVICE

Maps can be updated using a USB memory device.

For details and to download update data, refer to the following URL:

<https://subaru-maps.com/>

1. Connect to a USB memory device. (→P.66)
2. Select **Map Update** (Map Update) on the navigation settings screen. (→P.207)
3. → **USB** (USB)

## UPDATING THE MAP DATA MANUALLY USING Wi-Fi®

The map data may also be updated via Wi-Fi® network.

1. Connect to a Wi-Fi® network. (→P.85)
2. Select **Map Update** (Map Update) on the navigation settings screen. (→P.207)
3. → **Wi-Fi** (Wi-Fi)

4. Select the regions for which maps are to be updated.

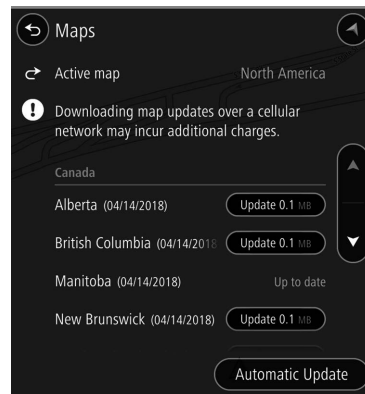

- When **Update XX MB** (Update XX MB) is selected

5. The update for the selected region will be automatically downloaded and installed.
  - After installation of the update is completed, a message will be displayed.

- When **Major Update XX MB** (Major Update XX MB) is selected

5. The map update data for the selected region will be automatically downloaded.
  - After downloading has completed, **Install All** (Install All) will be displayed.

6. → **Install All** (Install All)
7. → **Install Now** (Install Now)
  - During installation, the navigation function of the system cannot be used.
  - **Cancel** (Cancel): Select to cancel installing the map data.
8. → **OK** (OK)

### UPDATING THE MAP DATA AUTOMATICALLY USING Wi-Fi®

1. Follow “STEPS 1 to 3” in “UPDATING THE MAP DATA MANUALLY USING Wi-Fi”. (→P.213)
2. Select **Automatic Update** (Automatic Update).
3. Set “Update maps automatically (at most 8 maps can be selected)”.
4. Select the regions that you would like to be updated.

### UPDATING THE MAP DATA MANUALLY USING A SMARTPHONE

If the system cannot connect to a Wi-Fi® network, the map data can be updated using a smartphone. Map update data can be downloaded to a smartphone from outside of the vehicle, such as at home, and then transferred to the system to perform the map data update.

When updating the map data using a smartphone, the SUBARU STARLINK application must be installed on the smartphone.

#### NOTE

- When using a cellular network to download map update data, only regions with updates which are 30 MB or less can be downloaded. To download updates using a cellular network, it is necessary to turn the mobile data communication setting on the SUBARU STARLINK application on.

---

## DOWNLOAD MAP UPDATE DATA TO A SMARTPHONE

---

1. Connect a smartphone to the system via Bluetooth.
  - When using an iPhone, it can also be connected using a USB cable.
2. Start the SUBARU STARLINK application on the smartphone and download the map update data.

---

## INSTALL MAP UPDATE DATA

---

1. Connect a smartphone to the system via Bluetooth.
  - When using an iPhone, it can also be connected using a USB cable.

### ► When the “Map Update Via Mobile” screen is displayed

2. Select **Update Now** (Update Now).
  - If “Auto Update Via Mobile” is enabled, the map update data will be installed automatically when the smartphone is connected to the system.
3. → **Yes** (Yes)

### ► When the “Major Map Updates” screen is displayed

2. Select **Install Now** (Install Now).
  - During installation, the navigation function of the system cannot be used.
  - **Cancel** (Cancel): Select to cancel installing the map data.
3. → **OK** (OK)

## NOTE

- When downloading map data using the SUBARU STARLINK application, make sure there is sufficient storage space on the smartphone for the selected region map data.
- When using an iPhone to perform an update, connecting the iPhone to the system via USB is recommended. In this case, if a genuine Apple USB cable is used, high speed communication is possible.
- This product uses the smartphone’s data plan for features and services. Please consult carrier data plan usage, pricing, data overage charges, limitations and usage guidelines.

---

## ABOUT THE SUPPORTED DEVICES

---

This system supports the following devices.

- iPhone: iOS 13 or later
- Android: Android 9 or later

## NOTE

- To ensure normal operation, updating your smartphone operating system to the latest version is recommended.

# ***MEMO***

---

---

---

---

---

---

---

---

---

---

---

---

---

---

---

---

---

---

---

---

---

---

---

---

---



# Voice Recognition System



<b>Voice Recognition System Operation</b>	218
<b>Voice Recognition System</b> .....	218
Using The Voice Recognition System .....	218
Voice Recognition System Operation .....	219
<b>Command List</b> .....	220

## VOICE RECOGNITION SYSTEM OPERATION

### VOICE RECOGNITION SYSTEM

The voice recognition system enables the navigation, audio, hands-free systems, etc. to be operated using voice commands.

Refer to the command list for samples of voice commands.  
(→P.220)

### USING THE VOICE RECOGNITION SYSTEM

#### STEERING SWITCH

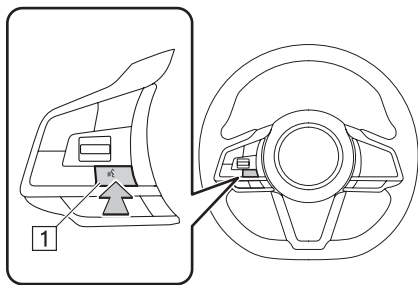

1 Talk switch

- Press the talk switch to start the voice recognition system.
- To cancel voice recognition, press and hold the talk switch.

#### MICROPHONE

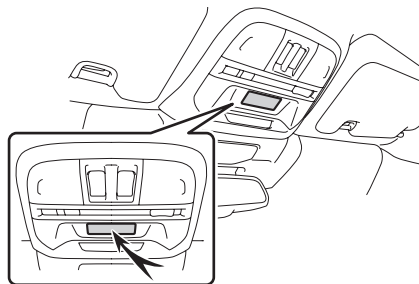

- It is unnecessary to speak directly into the microphone when giving a command.

#### NOTE

- This function or part of this function may not be available in some languages and countries.
- Wait for the confirmation beep before speaking a command.



## NOTE

- Voice commands may not be recognized if:
  - Spoken too quickly.
  - Spoken at a low or high volume.
  - Driving with a window open.
  - Passengers are talking while voice commands are spoken.
  - The air conditioning speed is set high.
  - When air from the ventilator blows directly toward the microphone.
- In the following conditions, the system may not recognize the command properly and using voice commands may not be possible:
  - The command is incorrect or unclear. Note that certain words, accents or speech patterns may be difficult for the system to recognize.
  - There is excessive background noise, such as wind noise.

## VOICE RECOGNITION SYSTEM OPERATION

### 1. Press the talk switch.

- After the voice recognition top screen has been displayed, speech guidance will commence.

### 2. Say the command.

#### ► 11.6-inch display system/11.6-inch display with Navi system

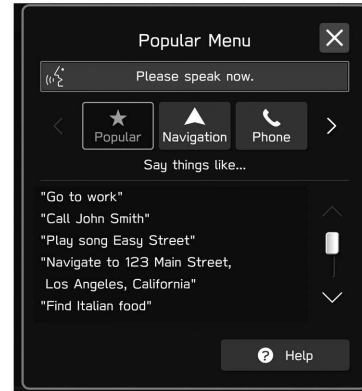

#### ► Dual 7.0-inch display system



- When selecting **Help** (Help) or saying **"Help"**, all commands supported by the system are listed.
- If a category name is selected, the selected category command list will be displayed.

- To cancel voice recognition, select , or press and hold the talk switch.

## NOTE

- Turn the “**VOLUME**” knob, or use the volume control switch on the steering wheel to adjust the speech guidance volume.

## COMMAND LIST

Recognizable voice commands and their actions are shown below.

- Frequently used commands are listed in the following tables.
- For devices that are not installed in the vehicle, the related commands will not be displayed in the screen. Also, according to conditions, other commands may not be displayed in the screen.
- The functions available may vary according to the system installed.
- If the system language is changed on the general settings screen, the language of the voice recognition function will also change.  
Refer to the vehicle Owner's Manual for details.

## NOTE

- The notations used in the commands are as follows.
  - <○○○>: Numbers, titles, or names to be spoken

## ► Navigation commands\*

\*: If equipped

Voice command	Function
Enter an address	Enables setting a destination by saying the address with city and state
Navigate to <address>	Enables setting a destination by saying the address with city and state
Find <POI>	Displays a list of POI category near the current position
Go home	Displays the route to home
Go to work	Displays the route to work
Cancel route	Cancels route guidance
Search favorites	Displays the favorite location
Favorite <favorite name*>	Displays the favorite location
Previous destination	Displays the previous destinations
Delete destination	Cancels route guidance
Show map	Displays the map screen
Find <POI> in a city	Displays a list of POI category near the current position
Change country <country>	Changes a country

\*: Depending on how the name of a registered favorite is entered, the way it should be spoken when using the voice recognition function will change.

- Lower case letters should be spoken phonetically.
- Upper case letters should be spoken as individual letters.

When speaking the name of registered points, be sure to say it as it is registered.

## ► Phone commands

Voice command	Function
Call a contact	Places a call to the spoken contact name and phone type of the contact from the phonebook
Call <name> <phone type>	Places a call to the spoken contact name and phone type of the contact from the phonebook
Pair phone	Displays "Manage Devices" screen
Send a text by contact	Sends the preset message to the spoken contact name and phone type of the contact from the phonebook
Dial a number	Places a call to the spoken phone number
Dial <number>	Places a call to the spoken phone number
Call back	Places a call to the phone number of the latest incoming call
Redial	Places a call to the phone number of the latest outgoing call
Show messages	Displays received text messages
Show recent calls	Displays the call history screen

Voice command	Function
Send a text to <number>	Sends a text message to the spoken phone number
Send a text by recent calls	Sends a text message by the recent call list
Send a text to <name> <phone type>	Sends a text message to the spoken contact name and phone type of the contact from the phonebook

### ► Music commands

Voice command	Function
Turn music on	Turns music on
Turn music off	Turns music off
Play song <name>	Plays the selected song
Play artist <name>	Plays tracks from the selected artist
Play playlist <name>	Plays tracks from the selected playlist
FM radio	Switches to FM radio
AM radio	Switches to AM radio
Sirius XM	Switches to SiriusXM® Radio
iPod	Switches to iPod/iPhone
Radio frequency	Tunes radio frequency
Go to a preset	Selects a preset
Channel <name>	Switches to a selected channel
Play genre <name>	Plays tracks from the selected genre
Play album <name>	Plays tracks from the selected album

Voice command	Function
Play composer <name>	Plays tracks from the selected composer
Play audiobook <name>	Plays the selected audiobook
Play podcast <name>	Plays the selected podcast
Browse genre <name>	Displays the list of artists of genre
Browse artist <name>	Displays the list of albums of the artist
Browse album <name>	Displays the list of songs of the album
Browse playlist <name>	Displays the list of playlist
Browse composer <name>	Displays the list of albums from the composer
Browse songs	Displays the list of songs
Browse audiobooks	Displays the list of audiobooks
Browse podcasts	Displays the list of podcasts
Auxiliary	Switches source to auxiliary
USB	Switches source to USB

Voice command	Function
Bluetooth audio	Switches source to Bluetooth audio
Disc*	Switches source to disc
Track <number>*	Plays the selected track
Tune to <frequency> AM	Tunes AM radio frequency
Tune to <frequency> FM	Tunes FM radio frequency
Tune to FM <frequency> HD <subchannel>	Tunes FM radio frequency
Listen to a radio genre	Selects a radio genre
Listen a <genre> FM station	Selects a radio genre
Tune to preset <number>	Selects a preset
Tune to channel number	Selects a satellite radio channel
Satellite channel <number>	Selects a satellite radio channel

\*: If equipped with a CD player

## NOTE

- Depending on the device, your iPod/iPhone may not work when operated via voice recognition.

► **Climate commands**

Voice command	Function
Auto AC on	Switches on the Auto AC mode on
Warmer	Increases the temperature
Cooler	Decreases the temperature
Increase fan speed	Increases the fan speed
Decrease fan speed	Decreases the fan speed
Set temperature to <temperature>	Sets the temperature to the spoken temperature
Fan speed <1 - 7>	Sets the fan speed to the spoken fan speed

► **Apps commands**

Voice command	Function
Launch <app name>	Changes screen to selected application
Weather	Changes screen to SiriusXM Travel Link Weather
Weather alert	Changes screen to SiriusXM Travel Link Weather Alerts
Parking	Changes screen to SiriusXM Travel Link Parking
Sports	Changes screen to SiriusXM Travel Link Sports
Go to SUBARU STARLINK	Changes screen to SUBARU STARLINK
Go to CarPlay	Changes screen to Apple CarPlay
Go to Android Auto	Changes screen to Android Auto
Stocks	Changes screen to SiriusXM Travel Link Stocks
Fuel prices	Changes screen to SiriusXM Travel Link Fuel Prices
Show weather for a city	Changes screen to SiriusXM Travel Link Weather
Show weather forecast for <city name>	Changes screen to SiriusXM Travel Link Weather



# Appendix/What To Do If/Index



<b>Certification</b>	226
<b>Certification</b> .....	226
SiriusXM® Radio .....	226
SiriusXM Data Service .....	226
Radio Wave Communications .....	226
Bluetooth .....	228
iPhone/iPod .....	228
Apple CarPlay .....	229
Android Auto .....	229
Gracenote .....	229
Others .....	229
<b>How To Get The Source Code Using The Open Source</b>	230

<b>What To Do If</b>	231
<b>Troubleshooting</b> .....	231
Troubleshooting Issues Common To This System .....	231
SUBARU STARLINK .....	231
Radio Operation .....	232
Phone .....	233
Updating The System .....	238
Map Update .....	240
<b>Index</b>	242

## CERTIFICATION

## CERTIFICATION

## SiriusXM® Radio



- © 2020 Sirius XM Radio Inc. Sirius, XM, SiriusXM and all related marks and logos are trademarks of Sirius XM Radio Inc. All other marks, channel names and logos are the property of their respective owners. All rights reserved.

## SiriusXM DATA SERVICE

Neither SiriusXM nor SUBARU CORPORATION is responsible for any errors or inaccuracies in the SiriusXM data services or its use in vehicle.

## RADIO WAVE COMMUNICATIONS

## ▶ U.S.A.

- FCC ID: HYQDNNS117
- FCC ID: HYQDNNS118
- This device complies with part 15 of the FCC Rules. Operation is subject to the following two conditions: (1) This device may not cause harmful interference, and (2) this device must accept any interference received, including interference that may cause undesired operation.

## ⚠ WARNING

- FCC WARNING:  
Changes or modifications not expressly approved by the party responsible for compliance could void the user's authority to operate the equipment.
- CAUTION: Radio Frequency Radiation Exposure  
This equipment complies with FCC radiation exposure limits set forth for an uncontrolled environment and meets the FCC radio frequency (RF) Exposure Guidelines. This equipment should be installed and operated keeping the radiator at least 20cm or more away from person's body.
- Co-location:  
This transmitter must not be co-located or operated in conjunction with any other antenna or transmitter.



## ► Canada

- This device contains licence-exempt transmitter(s)/receiver(s) that comply with Innovation, Science and Economic Development Canada's licence-exempt RSS(s). Operation is subject to the following two conditions:
  - (1) This device may not cause interference.
  - (2) This device must accept any interference, including interference that may cause undesired operation of the device.

The antenna cannot be removed (and changed) by user.

Co-location: This transmitter must not be co-located or operated in conjunction with any other antenna or transmitter.

L'émetteur/récepteur exempt de licence contenu dans le présent appareil est conforme aux CNR d'Innovation, Sciences et Développement économique Canada applicables aux appareils radio exempts de licence. L'exploitation est autorisée aux deux conditions suivantes :

- (1) L'appareil ne doit pas produire de brouillage;
- (2) L'appareil doit accepter tout brouillage radioélectrique subi, même si le brouillage est susceptible d'en compromettre le fonctionnement.

L'utilisateur n'est pas autorisé à retirer (ou modifier) l'antenne.

Emplacement : Cet émetteur ne doit pas être installé ou utilisé conjointement avec d'autres antennes ou émetteurs.

## ⚠ WARNING

### ● CAUTION: Radio Frequency Radiation Exposure

This equipment complies with ISED radiation exposure limits set forth for an uncontrolled environment and meets RSS-102 of the ISED radio frequency (RF) Exposure rules. This equipment should be installed and operated keeping the radiator at least 20 cm or more away from person's body.

ATTENTION: exposition aux radiofréquences

- Cet équipement est conforme aux limites d'exposition aux rayonnements d'ISDE établies pour un environnement non contrôlé ainsi que la norme CNR-102 de la réglementation d'ISDE relative à l'exposition aux radiofréquences (RF). Cet équipement doit être installé et utilisé avec un minimum de 20 cm de distance entre la source de rayonnement et le corps.

## ► México



- La operación de este equipo está sujeta a las siguientes dos condiciones: (1) es posible que este equipo o dispositivo no cause interferencia perjudicial y (2) este equipo o dispositivo debe aceptar cualquier interferencia, incluyendo la que pueda causar su operación no deseada.

## Bluetooth



- The Bluetooth® word mark and logos are registered trademarks owned by Bluetooth SIG, Inc. and any use of such marks by SUBARU CORPORATION and DENSO Corporation is under license. Other trademarks and trade names are those of their respective owners.

## iPhone/iPod



- Use of the Made for Apple badge means that an accessory has been designed to connect specifically to the Apple product(s) identified in the badge and has been certified by the developer to meet Apple performance standards. Apple is not responsible for the operation of this device or its compliance with safety and regulatory standards.
- Please note that the use of this accessory with an Apple product may affect wireless performance.
- iPhone, iPod, iPod classic, iPod nano, iPod touch, Lightning and App Store are trademarks of Apple Inc., registered in the U.S. and other countries and regions.

## Apple CarPlay



- Use of the Apple CarPlay logo means that a vehicle user interface meets Apple performance standards. Apple is not responsible for the operation of this vehicle or its compliance with safety and regulatory standards. Please note that the use of this product with iPhone or iPod may affect wireless performance.
- Apple, iPhone, iPod, iPod touch and Apple CarPlay are trademarks of Apple Inc., registered in the U.S. and other countries and regions.

## Android Auto

androidauto

- Android Auto is a trademark of Google LLC.

## Gracenote

- Gracenote, the Gracenote logo and logotype are either a registered trademark or a trademark of Gracenote, Inc. in the United States and/or other countries.



## OTHERS

- QR Code is registered trademarks of DENSO WAVE INCORPORATED.
- QR Code est une marque déposée de DENSO WAVE INCORPORATED.
- © 1982-2013, QNX Software Systems Limited. All rights reserved.
- Cinema is a trademark of Cinema GmbH, Karlsruhe. Please visit <http://www.cinemo.com>

## HOW TO GET THE SOURCE CODE USING THE OPEN SOURCE

This product contains Free/Open Source Software(FOSS).

The license information and/or the source code of such FOSS can be found at the following URL.

<http://www.globaldenso.com/en/opensource/ivi/subaru/>

## WHAT TO DO IF

## TROUBLESHOOTING

## TROUBLESHOOTING ISSUES COMMON TO THIS SYSTEM

Symptom	Cause	Action
The touch screen becomes unresponsive during operation.	An error has occurred in the system.	Press and hold the "VOLUME" knob for 10 seconds or longer to reset the system.
The sound suddenly stops working.		
Only the background is displayed on the screen and no icons appear.		

## SUBARU STARLINK

## ► Dual 7.0-inch display system only

Symptom	Likely cause	Solution	Page
SUBARU STARLINK does not start.	The time does not match.	Connect your smartphone.	79
		Set the phonebook download function to on.	82

## RADIO OPERATION

Symptom	Cause	Action
Mismatch of time alignment- a user may hear a short period of programming replayed or an echo, stutter or skip.	The radio stations analog and digital volume is not properly aligned or the station is in ballgame mode.	None, radio broadcast issue. A user can contact the radio station.
Sound fades, blending in and out.	Radio is shifting between analog and digital audio.	Reception issue, may clear-up as the vehicle continues to be driven. Turning the indicator of the HD Radio button off can force radio in an analog audio.
Audio mute condition when an HD2/HD3 multicast channel had been playing.	The radio does not have access to digital signals at the moment.	This is normal behavior, wait until the digital signal returns. If out of the coverage area, seek a new station.
Audio mute delay when selecting an HD2/HD3 multicast channel preset.	The digital multicast content is not available until HD Radio™ broadcast can be decoded and make the audio available. This takes up to 7 seconds.	This is normal behavior, wait for the audio to become available.
Text information does not match the present song audio.	Data service issue by the radio broadcaster.	Broadcaster should be notified.
No text information shown for the present selected frequency.	Data service issue by the radio broadcaster.	Broadcaster should be notified.

## PHONE

If there is a problem with the hands-free system or a Bluetooth phone, first check the table below.

### ► When using the hands-free system with a Bluetooth phone

Symptom	Likely cause	Solution	Page	
			Cellular phone	This system
The hands-free system or Bluetooth phone does not work.	The connected Bluetooth phone may not be a compatible Bluetooth cellular phone.	For a list of specific Bluetooth phones which operation has been confirmed on this system. For USA customers, please visit <a href="http://www.subaru.com">www.subaru.com</a> for details. Outside of the USA customers, contact your local dealer to arrange a demonstration in order to confirm whether or not the phone can be paired with the vehicle.	*	75
	The Bluetooth version of the connected cellular phone may be older than the specified version.	Use a cellular phone with Bluetooth version 2.1 or higher. Recommended: Ver. 4.2 or higher	*	75

\*: For details, refer to the owner's manual that came with the cellular phone.

### ► When registering/connecting a cellular phone

Symptom	Likely cause	Solution	Page	
			Cellular phone	This system
A cellular phone cannot be registered.	An incorrect passcode was entered on the cellular phone.	Enter the correct passcode on the cellular phone.	*	-
	The registration operation has not been completed on the cellular phone side.	Complete the registration operation on the cellular phone (approve registration on the phone).	*	-
	Old registration information remains on either this system or the cellular phone.	Delete the existing registration information from both this system and the cellular phone, then register the cellular phone you wish to connect to this system.	*	81
A Bluetooth connection cannot be made.	Another Bluetooth phone is already connected.	Manually connect the cellular phone you wish to use to this system.	-	79
	Bluetooth function is not enabled on the cellular phone.	Enable the Bluetooth function on the cellular phone.	*	-

\*: For details, refer to the owner's manual that came with the cellular phone.

### ► When making/receiving a call

Symptom	Likely cause	Solution	Page	
			Cellular phone	This system
A call cannot be made/received.	Your vehicle is in a "No Service" area.	Move into the service area.	-	-



► **When using the phonebook**

Symptom	Likely cause	Solution	Page	
			Cellular phone	This system
Phonebook data cannot be transferred automatically.	The profile version of the connected cellular phone may not be compatible with transferring phonebook data.	For a list of specific Bluetooth phones which operation has been confirmed on this system. For USA customers, please visit <a href="http://www.subaru.com">www.subaru.com</a> for details. Outside of the USA customers, contact your local dealer to arrange a demonstration in order to confirm whether or not the phone can be paired with the vehicle.	*	75
	Automatic contact transfer function on this system is set to off.	Set automatic contact transfer function on this system to on.	-	82

\*: For details, refer to the owner's manual that came with the cellular phone.

**► When using the Bluetooth message function**

Symptom	Likely cause	Solution	Page	
			Cellular phone	This system
Messages cannot be viewed.	Message transfer is not enabled on the cellular phone.	Enable message transfer on the cellular phone (approve message transfer on the phone).	*	-

\*: For details, refer to the owner's manual that came with the cellular phone.

## ► In other situations

Symptom	Likely cause	Solution	Page	
			Cellular phone	This system
Even though all conceivable measures have been taken, the symptom status does not change.	The cellular phone is not close enough to this system.	Bring the cellular phone closer to this system.	-	-
	The cellular phone is the most likely cause of the symptom.	Turn the cellular phone off, remove and reinstall the battery pack, and then restart the cellular phone.	*	-
		Enable the cellular phone's Bluetooth connection.	*	-
		Stop the cellular phone's security software and close all applications.	*	-
		Before using an application installed on the cellular phone, carefully check its source and how its operation might affect this system.	*	-

\*: For details, refer to the owner's manual that came with the cellular phone.

## UPDATING THE SYSTEM

If a problem occurs when attempting to perform a system update, refer to the following table.

Symptom	Cause	Solution
"A software download error occurred. Please try again." is displayed.	The set time of the clock and actual time differ greatly.	Set the clock to the correct time. <ul style="list-style-type: none"> <li>• 11.6-inch display with Navi system/11.6-inch display system with SUBARU STARLINK Safety and Security: Move the vehicle to an area where GPS signals can be received normally.</li> <li>• 11.6-inch display system without SUBARU STARLINK Safety and Security: Move the vehicle to an area where cellular phone reception is good.</li> </ul>
	An error occurred at the server. (Server cannot respond temporarily due to maintenance, etc.)	Wait for the server to return to normal.
"No server response. Please try again." is displayed.	The connection between the system and the Wi-Fi® access point is weak or has been lost.	Connect the system to the Wi-Fi® access point again and perform the update in an area with low electrical noise.
	Communication between the Wi-Fi® access point and server has been lost.	Check that the Wi-Fi® access point can connect to the internet and perform the update in an area with low electrical noise.

Symptom	Cause	Solution
"Connection failed. Unable to check for updates because no active internet connection has been detected" is displayed.	The connection between the system and the Wi-Fi® access point is weak or has been lost.	Connect the system to the Wi-Fi® access point again and perform the update in an area with low electrical noise.

## MAP UPDATE (IF EQUIPPED)

If a problem occurs when attempting to perform a map update, refer to the following table.

### ► Errors when updating via USB

Error code	Cause	Solution
"Installation Failed (1)"	Reading of the data on the USB memory device failed.	Disconnect and then reconnect the USB memory device, check that it is connected correctly, and attempt to perform the update again.
"Installation Failed (2)"	Corruption of the data on the USB memory device was detected.	Attempt to perform the update again. If the same error is detected, download the map update data again, copy it to a different USB memory device and attempt to perform the update again.
"Installation Failed (5)"	An error in the system data was detected while performing the update.	Attempt to perform the update again. If the same error is detected, download the map update data again, copy it to a different USB memory device and attempt to perform the update again.
"Installation Failed (X)"	An unspecified error has occurred.	Attempt to perform the update again. If the same error is detected, contact your SUBARU dealer.

**► Errors when updating via Wi-Fi®, smartphone**

Error code	Cause	Solution
404	The system ID number of the center information display is not registered to the server.	Contact your SUBARU dealer.
XXX	An error occurred with the connected server.	Wait for a while and then attempt to perform the update again. If the update procedure fails again, contact your SUBARU dealer.

## INDEX

## A

AM radio .....	143
Android Auto .....	124
Apple CarPlay .....	121
AUX .....	168

## B

Bluetooth .....	74
Profiles .....	75
Registering Bluetooth device .....	74
Bluetooth audio .....	165
Bluetooth phone message .....	106

## C

Calling on Bluetooth phone .....	100
By contacts list .....	103
By favorites list .....	102
By keypad .....	102
By recent calls list .....	101
CD .....	158
Command list .....	220

## D

Destination search .....	195
Driver profile .....	23, 44

## E

Entering letters, numbers/list screen .....	68
Entering letters/numbers .....	68
List screen operation .....	69

## F

Favorites settings .....	198
FM radio .....	143

## G

General settings .....	83
GPS .....	209
Limitations .....	209

## H

Hands-free system .....	96
Home screen operation .....	72
Adding shortcut icons .....	72
Moving/deleting shortcut icons .....	72

## I

Initial screen .....	64
iPod/iPhone .....	162



**M**

Map data .....	212
Update .....	212
Map screen information .....	191
Map screen operation .....	187
Current position display .....	187
Map scale .....	188
Orientation of the map .....	189
Media operation .....	158
AUX .....	168
Bluetooth audio .....	165
CD .....	158
iPod/iPhone .....	162
USB memory .....	160
Memory points settings .....	198

**N**

Navigation settings .....	207
---------------------------	-----

**P**

Phone settings .....	77
----------------------	----

**R**

Radio operation .....	143
AM/FM radio .....	143
SiriusXM® radio .....	149
Receiving on Bluetooth phone .....	103
Incoming calls .....	103
Route guidance .....	203
Route related functions .....	196, 201

**S**

Screen adjustment .....	70
Adjusting brightness .....	70
Day and night mode .....	70
Search operation .....	195
Setting .....	73
General .....	83
Navigation .....	207
Phone .....	77
Radio .....	91
Sound .....	90
SiriusXM® radio .....	149
SiriusXM Travel Link .....	127
Sound settings .....	90
Status display .....	71
Steering wheel controls .....	173
SUBARU STARLINK .....	115

**T**

Talking on Bluetooth phone .....	104
Touch screen gestures .....	66
Touch screen operation .....	67
Traffic information .....	191
Troubleshooting .....	231
Typical voice guidance prompts .....	206

**U**

USB memory .....	160
------------------	-----

**V**

Voice recognition system .....	218
--------------------------------	-----