

## Foreword

---

Congratulations on choosing a SUBARU vehicle equipped with EyeSight™. EyeSight incorporates the latest driver assistance features available from SUBARU, including such features as Adaptive Cruise Control, a Lead Vehicle Start Alert and a Lane Departure and Lane Sway Warning, all of which are designed to assist the driver in making decisions and increase driver comfort and convenience. Initially, the operation and use of the various EyeSight features may be unfamiliar to you. That is why we urge you to read this manual carefully before using EyeSight. We also recommend that you first take the time to test EyeSight in order to experience its features for yourself so that you can become familiar with their operation.

Please keep in mind that it is the responsibility of drivers to operate their vehicles safely at all times. Drivers should always remain alert and should never become complacent while operating their vehicles because of the presence of EyeSight. EyeSight is never a substitute for active driver involvement and it may not operate optimally under all driving conditions.

This booklet is a supplement to the Owner's Manual for your SUBARU vehicle and contains a detailed description of EyeSight. It should be read in conjunction with your Owner's Manual so that you will gain a thorough understanding of the proper operation of your vehicle.

The information, specifications and illustrations found in this booklet are those in effect at the time of printing. SUBARU CORPORATION reserves the right to change specifications and designs at any time without prior notice and without incurring any obligation to make the same or similar changes on vehicles previously sold.

Please keep this booklet together with your Owner's Manual and leave it in the vehicle at the time of resale. The next owner will need the information it contains.

**SUBARU CORPORATION, TOKYO, JAPAN**

 **SUBARU** is a registered trademark of SUBARU CORPORATION.

© Copyright 2017 SUBARU CORPORATION

# EyeSight

About EyeSight .....	2
Pre-Collision Braking System.....	21
Adaptive Cruise Control .....	33
Lane Keep Assist .....	53
Pre-Collision Throttle Management.....	61
Lane Departure Warning .....	67
Lane Sway Warning .....	70
Lead Vehicle Start Alert .....	73
Conventional Cruise Control .....	74
List of buzzer sounds .....	84
EyeSight malfunction and temporary stop .....	86
Customizing functions .....	90
Message screen list .....	92
Troubleshooting .....	95

# About EyeSight

## EyeSight

EyeSight is a driving support system that uses a range of functions to assist the driver in making decisions in order to provide for more safe and comfortable driving and to reduce driver fatigue. Making use of images created by the stereo camera specially designed by SUBARU, EyeSight detects the vehicle in front, obstacles, traffic lanes and other items.



### WARNING

**Drivers are responsible for driving safely. Always comply with all traffic rules and regulations regardless of the fact that your vehicle is equipped with EyeSight. Always maintain a safe following distance between your vehicle and the vehicle in front of you, pay attention to your surroundings and driving conditions, and take necessary actions in order to maintain a safe following distance.**

**Never attempt to drive relying on EyeSight alone.**

**EyeSight is intended to assist the driver in making decisions in order to reduce the risk of accidents or damage and lessen the burden on the driver.**

**When an EyeSight warning is activated, pay attention to what is in front of you and to your surroundings, and take necessary actions. This system is not designed to support driving in poor visibility or in extreme weather conditions, or to protect against careless driving when the driver is not paying complete attention to the road ahead. It also cannot prevent collisions from occurring in all driving conditions.**

**There are limits to the EyeSight recognition performance and control performance. Be sure to read the instructions for each function before using the system, and always use it properly. Improper use may lead to failure of control performance, which could cause an accident.**

Refer to the following pages for each function:

- For the Pre-Collision Braking System, refer to page 21.
- For Adaptive Cruise Control, refer to page 33.
- For Lane Keep Assist, refer to page 53.
- For Pre-Collision Throttle Management, refer to page 61.
- For Lane Departure Warning, refer to page 67.
- For Lane Sway Warning, refer to page 70.
- For Lead Vehicle Start Alert, refer to page 73.
- For Conventional Cruise Control, refer to page 74.

**The EyeSight system in your vehicle is designed for use in countries in which traffic drives on the right-hand side of the road. EyeSight for LHD vehicles such as yours is not designed for use in countries in which vehicles are driven on the left-hand side of the road.**

- The system may not operate correctly under the conditions listed below. When these conditions occur, turn off the Pre-Collision Braking System. Also, do not use Adaptive Cruise Control and Conventional Cruise Control.
  - The tire pressure is not correct.\*1
  - The temporary spare tire is installed.\*1

- Tires that are unevenly worn or tires with uneven wear patterns are installed.\*<sup>1</sup>
- Tires that are the wrong size are installed.\*<sup>1</sup>
- Flat tires that have been fixed temporarily with a tire repair kit.
- The suspension has been modified (including a genuine SUBARU suspension that has been modified).
- Any object that obstructs the stereo camera's view is installed on the vehicle.
- The headlights are dirty or they have snow and ice or dirt on them. (Objects are not correctly illuminated and are difficult to detect.)
- The optical axes are not aligned correctly. (Objects are not correctly illuminated and are difficult to detect.)
- The lights including headlights and fog lights have been modified.
- Vehicle operation has become unstable due to an accident or malfunction.
- The brake system warning light is illuminated in red.\*<sup>2</sup>
- A heavy cargo is loaded onto or inside the vehicle.
- The maximum number of occupants is exceeded.
- The combination meter is not operating properly; such as when the lights do not illuminate, the beeps do not sound, the display is different from when it is normal, etc.\*<sup>3</sup>

\*1: The wheels and tires have functions that are critically important. Be sure to use the correct ones. For details, refer to the Owner's Manual for your vehicle.

\*2: If the brake system warning light does not turn off, immediately pull the vehicle over in a safe place and contact a SUBARU dealer to have the system inspected. For details, refer to the Owner's Manual for your vehicle.

\*3: For details about the combination meter, refer to the Owner's Manual for your vehicle.

**CAUTION**

- The characteristics of the stereo camera are similar to those of human eyes. For this reason, conditions that make it difficult for the driver to see in the forward direction have the same effect on the stereo camera. They also make it difficult for the system to detect vehicles, obstacles, and traffic lanes.
- Detection by the EyeSight system is limited to objects that are within the range of the stereo camera's field of view. Also, after an object enters the range of the camera's field of view, it may take some time for the system to detect it as a controllable target and to warn the driver.

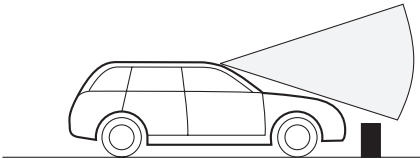

Low objects surrounding the vehicle cannot be detected.

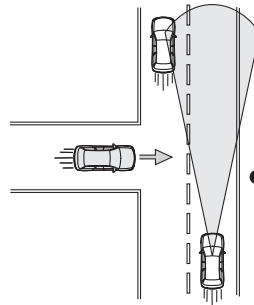

S01970

- Under the conditions listed below, it will become more difficult for the system to detect the vehicle in front, motorcycles, bicycles, pedestrians and obstacles on the road, and lane markers. Also, EyeSight may temporarily stop operating. However, the temporary stop will be canceled once these conditions have improved and the vehicle is driven for a short period of time.
  - Bad weather (for example heavy rain, a blizzard or thick fog). In particular, the system is more likely to temporarily stop operating when there is an oil film adhering to the windshield, a glass coating has been applied, or poorly performing wipers are used.
  - When affected by strong light from the front (sunlight or headlight beams of oncoming traffic, etc.)
  - When the windshield washer is being used.
  - When raindrops, water drops, or dirt on the windshield are not wiped off sufficiently
  - When the windshield has become fogged, scratched, or snow, dirt, dust or frost has adhered to it, or it is otherwise affected, these will reduce the stereo camera's field of view.
  - The vehicle is tilted at an extreme angle due to loaded cargo or other factors.
  - When visibility is poor due to sand, smoke or water vapor blowing in the wind, or when the front vision is obscured due to water splashes, snow, dirt or dust stir up generated by the vehicle in front or oncoming traffic

- When the stereo camera's field of view is obstructed (for example by a canoe on the roof of the vehicle)
- When passing through the entrance or exit of a tunnel
- When the rear aspect of the vehicle in front is low, small or irregular (for example a low bed trailer, etc.)
- When the obstacle is a fence, a wall or a shutter, etc. with a uniform pattern (a striped pattern, brick, etc.) or with no pattern in front
- When the obstacle is a wall or door made of glass or a mirror in front
- When driving at night or in a tunnel when there is a vehicle in front that does not have its taillights on
- When driving through a banner or flag, low branches on a tree or thick/tall vegetation
- On steep uphill or downhill grades
- When the stereo camera is obstructed by a hand, etc. (If even one of the lens is obstructed, the system does not operate properly.)
- When it is completely dark and no objects are detected
- When the area around the vehicle has a uniform color (such as when completely covered in snow, etc.)
- When accurate detection is not possible due to reflections in the windshield
- Under the conditions listed below, EyeSight may temporarily stop operating. If this occurs, EyeSight will resume operating when the conditions improve.
  - The temperature inside the vehicle is high, such as after the vehicle was left in bright sunshine, or the temperature inside the vehicle is low, such as after the vehicle was left in an extremely cold environment.
  - Immediately after the engine starts
- Under the conditions listed below, it is difficult to recognize vehicles in front, motorcycles, pedestrians, obstacles on the road, traffic lanes, etc. Also, the EyeSight system may temporarily stop operating. If the EyeSight system repeatedly stops operating several times, contact a SUBARU dealer and have the system inspected.
  - When the stereo camera lenses are smeared such as from fingerprints
  - When the stereo camera has become misaligned due to a strong impact
- When there is a malfunction in the EyeSight system, turn off the Pre-Collision Braking System (⇒ Refer to page 31) and the Lane Departure Warning (⇒ Refer to page 69), and stop using the Adaptive Cruise Control and Conventional Cruise Control. Contact a SUBARU dealer and have the system inspected.
- When the Vehicle Dynamics Control warning light is illuminated, the Pre-Collision Braking System may not operate properly. If the indicator light is illuminated, turn off the Pre-Collision Braking System. Also, do not use the Adaptive Cruise Control or Conventional Cruise Control.



**NOTE**

- EyeSight records and stores the following data when the Pre-Collision Braking System is operated. It does not record conversations or other audio data.
    - Stereo camera image data
    - Distance from the vehicle in front
    - Vehicle speed
    - Steering wheel turning angle
    - Lateral movement with regards to the direction of travel
    - Accelerator pedal operation status
    - Brake pedal operation status
    - Select lever position
    - Odometer reading
    - Data related to ABS, Vehicle Dynamics Control and Traction Control Function
- SUBARU and third parties contracted by SUBARU may acquire and use the recorded data for the purpose of vehicle research and development. SUBARU and third parties contracted by SUBARU will not disclose or provide the acquired data to any other third party except under the following conditions.
- The vehicle owner has given his/her consent.
  - The disclosure/provision is based on a court order or other legally enforceable request.
  - Data that has been modified so that the user and vehicle cannot be identified is provided to a research institution for statistical processing or similar purposes.

## Handling of the Stereo Camera

The stereo camera is located on the front map lights unit.

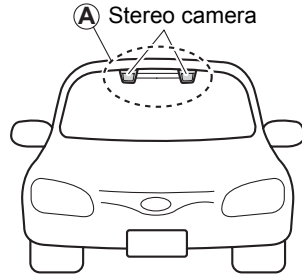

S01107

### CAUTION

- The stereo camera monitors and detects smears or blurs on the front of the camera. However, detection is not 100% accurate. Under certain conditions, the function may fail to detect smears or blurs on the front of the stereo camera accurately. In addition, this function may not detect that there is snow or ice on the windshield close to the stereo camera. In such conditions, be sure to keep the windshield clean at all times (indicated by ). Otherwise the system may not operate correctly. When this function detects that the front of the stereo camera is smeared or blurred, no EyeSight functions can be activated except for Conventional Cruise Control.
- The stereo camera lenses are precision components. Always observe the following precautions especially when handling them.
  - Never touch the stereo camera lenses, and do not attempt to wipe or clean the lenses. Doing so could damage or soil the lens, and lead to improper system performance.
 If you ever touch a lens for any reason, be sure to contact a SUBARU dealer.

Continued on next page ⇒



⇒ Continued from previous page

- When cleaning the windshield, cover the front of the camera casing with paper that does not collect dust, such as copy paper. Affix the paper to prevent glass cleaner from getting on the camera lenses. At this point, make sure that the tape's adhesive surface does not come in contact with the windshield or the lens. Be sure to remove the paper after cleaning.
- When having the inside of windshield cleaned at a service station, etc., be sure to request that the attendant covers the camera covers before washing the vehicle.
- Do not subject the stereo camera to a strong impact.
- Do not remove or disassemble the stereo camera.
- Do not change the positions where the stereo camera is installed or modify any of the surrounding structures.
- Do not install an interior rearview mirror other than a genuine SUBARU rearview mirror (such as a wide-type mirror) and the sun visor. Also, use the rearview mirror so that it does not obstruct the stereo camera. Failure to do so may affect the stereo camera's field of view and could prevent the EyeSight system from functioning properly.

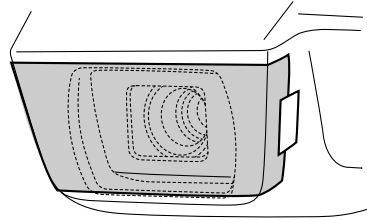

S01097

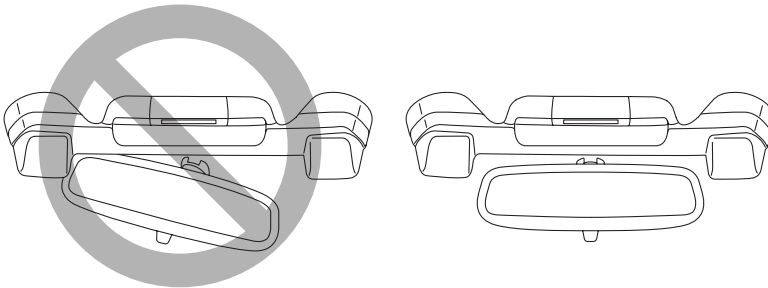

S00509

- Do not install any accessories other than the ones designated by SUBARU on the prohibited areas shown in the illustrations (grey zones). Even if some accessories are installed on the outside of the prohibited areas, abnormal operation of EyeSight may occur due to the reflection of the light or any objects. In this situation, move the accessories. For details, contact a SUBARU dealer.

&lt;Side view&gt;

&lt;Front view&gt;

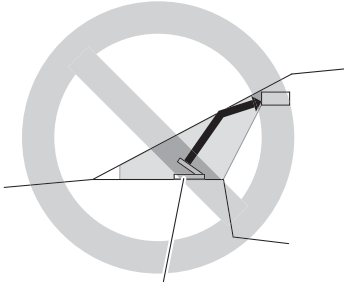

Monitors or other accessories

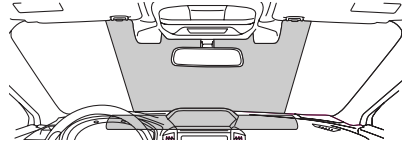

S02664

- Do not place any objects on top of the instrument panel. The stereo camera may not be able to detect objects accurately and the EyeSight system may not function properly due to reflections in the windshield. For details, contact a SUBARU dealer.
- If the top of the instrument panel is polished with chemicals or other substances, the stereo camera may not be able to detect objects accurately and the EyeSight system may not operate properly due to reflections in the windshield.
- Do not install any wiper blades other than genuine SUBARU wiper blades. Doing so may affect the stereo camera's field of view and could prevent the EyeSight system from functioning properly.
- Replace damaged wiper blades or worn wiper blade rubbers as soon as possible. Using damaged wiper blades or worn wiper blade rubbers may cause streaking on the windshield. The stereo camera may not be able to detect objects accurately and the EyeSight system may not function properly due to streaks or droplets remaining on the windshield.
- Do not install any accessories on the front side such as on the hood or the grille. It may affect the camera view and the system may not operate correctly.
- Make sure that the cargo loaded on the roof does not interfere in the stereo camera's field of view. Obstructing the stereo camera's view may impair the system operation. For details, contact a SUBARU dealer.

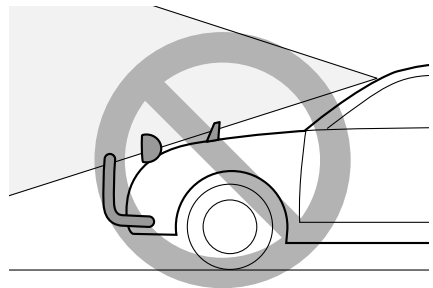

S01098

Continued on next page ⇒

⇒ Continued from previous page

- Keep the windshield (outside and inside) clean at all times. When the windshield has become fogged, or it has a dirt or an oil film on it, the stereo camera may not detect objects accurately and the EyeSight system may not operate correctly. Never mount any device to the center air vent, as any airflow change may impact performance of the EyeSight system.
- Do not place any stickers or accessories on the windshield (outside or inside). If you have to do so (for example, legally required or electronic toll tag), avoid the area directly in front of the camera. Otherwise, it may adversely affect the field of view of the stereo camera and can cause improper operation of the system. For details, contact a SUBARU dealer.
- Do not use any glass coating agents or similar substances on the windshield. Doing so may interfere with the proper operation of the system.
- Do not install any film or an additional layer of glass on the windshield. The system may not operate correctly.
- If there are scratches or cracks on the windshield, contact a SUBARU dealer.
- To have the windshield replaced or repaired, contact a SUBARU dealer. Do not install a windshield other than a genuine SUBARU windshield. The stereo camera may not be able to detect objects accurately and the EyeSight system may not operate properly.

## EyeSight Functions

EyeSight includes the following functions.

### ■ Pre-Collision Braking System

This function uses a following distance warning feature to warn the driver to take evasive action when there is the possibility of a collision with a vehicle or obstacle in front of you. If the driver does not take evasive action, the brakes are applied automatically to help reduce vehicle collision damage or, if possible, help prevent a collision.

⇒ Refer to page 21.

### ■ Adaptive Cruise Control

This function maintains the set vehicle speed and when there is a vehicle in front in the same traffic lane, it follows the speed of the vehicle in front up to the maximum of the set vehicle speed.

⇒ Refer to page 33.

### ■ Lane Keep Assist

This function helps suppress lane drifting by detecting lane markings (e.g., white lines) on highways and roads, and by assisting steering operation.

⇒ Refer to page 53.

### ■ Pre-Collision Throttle Management

This function reduces accidental forward movement caused by the select lever being placed in the wrong position or the accelerator pedal being accidentally depressed, or depressed too strongly.

⇒ Refer to page 61.

### ■ Lane Departure Warning

This function warns the driver when the vehicle is about to drift off the road.

⇒ Refer to page 67.

## ■ Lane Sway Warning

This function warns the driver when it detects vehicle drifting caused by driver fatigue, failure to concentrate on the road, inattention, strong crosswinds or other factors.

⇒ Refer to page 70.

## ■ Lead Vehicle Start Alert

This function notifies the driver when the vehicle stopped in front starts moving but the driver's vehicle remains stationary.

⇒ Refer to page 73.

## ■ Conventional Cruise Control

In this mode, the system maintains a constant vehicle speed. It does not follow the vehicle in front. This function can be used even when the stereo camera has temporarily stopped operating. (⇒ Refer to page 88.) (This function is used by switching from Adaptive Cruise Control to Conventional Cruise Control.)

⇒ Refer to page 74.



### **NOTE**

EyeSight does not operate when the engine is not running.

## Instrument panel display layout

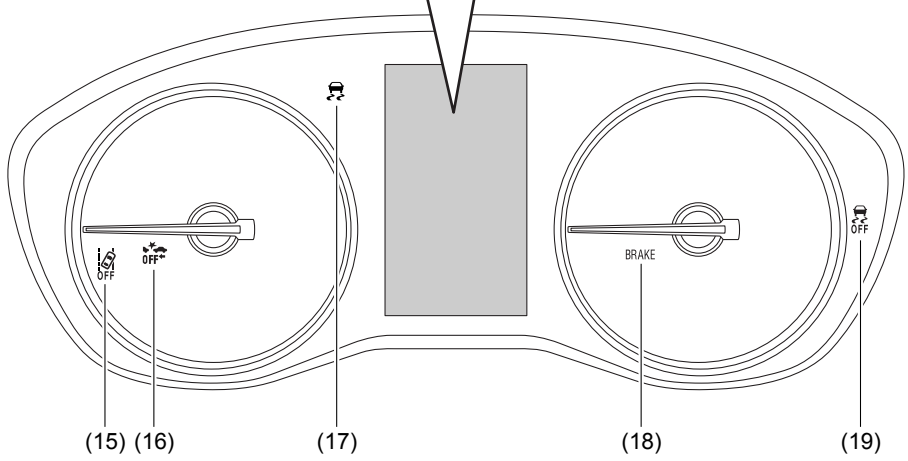
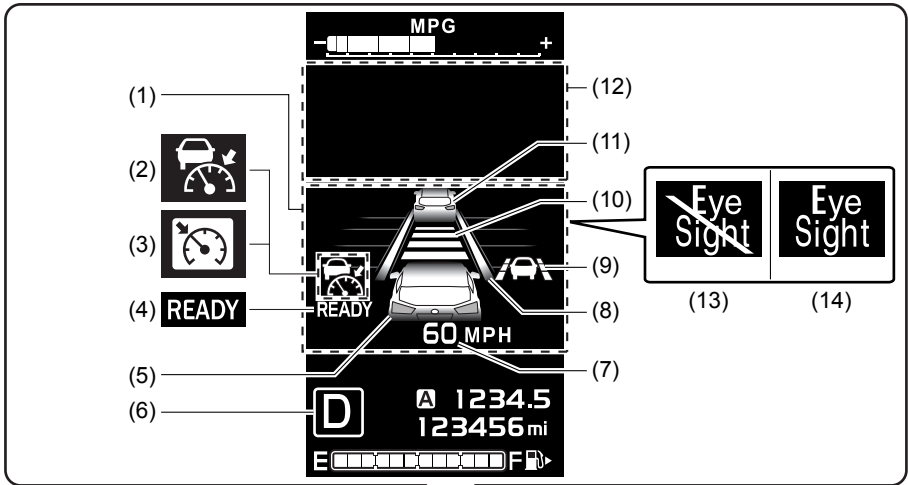

S02770

\* Display units can be changed in the Screen Settings. For details, refer to the Owner's Manual for your vehicle.

- |   |   |
|---|---|
| (1) EyeSight display area                 | (11) Lead vehicle indicator                           |
| (2) Adaptive Cruise Control indicator     | (12) Warning screen area                              |
| (3) Conventional Cruise Control indicator | (13) EyeSight temporary stop indicator (White)        |
| (4) READY indicator                       | (14) EyeSight warning indicator (Yellow)              |
| (5) Your vehicle indicator                | (15) Lane Departure Warning OFF indicator light       |
| (6) Select lever/gear position indicator  | (16) Pre-Collision Braking System OFF indicator light |
| (7) Set vehicle speed display             | (17) Vehicle indicator                                |
| (8) Lane Indicator                        | (18) Brake system warning light                       |
| (9) Lane keep Assist indicator            | (19) Vehicle Dynamics Control OFF indicator light     |
| (10) Following distance setting indicator |   |

## ■ CRUISE indicator

- This indicator illuminates when the main cruise control is on.



: Adaptive Cruise Control (Adaptive Cruise Control indicator)



: Conventional Cruise Control (Conventional Cruise Control indicator)

⇒ Refer to pages 39 and 74.

- When cruise control\* is set, this indicator (white) turns green. When the driver accelerates the vehicle by depressing the acceleration pedal while the Adaptive Cruise Control is operating, the indicator turns white.

⇒ Refer to pages 41 and 77.

\* Adaptive Cruise Control and Conventional Cruise Control

## ■ READY indicator

**READY** illuminates when cruise control\* can be set.

⇒ Refer to pages 39 and 76.



\* Adaptive Cruise Control and Conventional Cruise Control

## ■ Lead vehicle indicator

When Adaptive Cruise Control is set or when the vehicle is stopped, this indicator illuminates when a vehicle in front has been detected.

⇒ Refer to page 41.

## ■ Following distance setting indicator

Indicates the following distance setting that was set with the  /  (Following distance setting) switch.

⇒ Refer to page 46.

## ■ Set vehicle speed display

Displays the set vehicle speed.

⇒ Refer to pages 39 and 75.



## ■ Select lever/gear position indicator

- This indicator illuminates and shows which position the select lever or the gear is in.

## ■ EyeSight warning indicator (yellow)

- This indicator illuminates or flashes when a malfunction occurs in the EyeSight system.
  - When it is illuminated or flashing, none of the EyeSight functions can be used (including Adaptive Cruise Control and the Pre-Collision Braking System, etc.).
- ⇒ Refer to page 86.

## ■ EyeSight temporary stop indicator (white)

- This indicator illuminates when the EyeSight system is temporarily stopped.
  - When the ignition switch is placed in the ON position, it will illuminate if the  (CRUISE) switch or  (Lane Keep Assist) switch is set to ON within approximately 7 seconds of the engine starting. It turns off when approximately 7 seconds have elapsed since the engine started.
  - When it is illuminated, none of the EyeSight functions can be used except for Conventional Cruise Control.
- ⇒ Refer to page 88.

## ■ Lane Departure Warning OFF indicator light

- This indicator illuminates when the Lane Departure Warning and Lane Sway Warning are off.
  - It also illuminates when the ignition switch is turned to the ON position. Approximately 7 seconds after the engine starts, the Lane Departure Warning OFF indicator light will turn off or remain illuminated depending on the current status (ON or OFF).
- ⇒ Refer to page 69.

## ■ Pre-Collision Braking System OFF indicator light

- Illuminates when the Pre-Collision Braking System and Pre-Collision Throttle Management are off.
  - It also illuminates when the ignition switch is turned to the ON position, and then turns off approximately 7 seconds after the engine starts.
- ⇒ Refer to page 32.

## ■ Lane Indicator

This indicator illuminates in gray when the Lane Keep Assist switch is pressed. When the Lane Keep Assist is operational or operating, this indicator illuminates in white.

⇒ Refer to page 57.



## ■ Brake System warning light

The brake system warning light illuminates when:

- There is a malfunction in the brake system.
- The parking lever is pulled up.
- The brake fluid level is low.

The EyeSight system will not operate when the brake system warning light is on due to the parking brake lever being pulled up or a malfunction in the brake system.

It may operate when the brake system warning light is on due to a low brake fluid level, however there may be insufficient braking force.

If the brake system warning light does not turn off, immediately pull the vehicle over in a safe place and contact a SUBARU dealer to have the system inspected.

⇒ Refer to the vehicle Owner's Manual for details.

## ■ Your vehicle indicator

When the brake pedal is depressed or the brake control function is activated, the brake indicator light illuminates in red.

## ■ Vehicle Dynamics Control OFF indicator light

- This indicator light illuminates when the ignition switch is turned to the "ON" position, and it turns off after approximately 2 seconds.
- This indicator light illuminates when the Vehicle Dynamics Control OFF switch is pressed and Vehicle Dynamics Control is off.

⇒ Refer to the vehicle Owner's Manual for details.

## ■ Lane Keep Assist indicator

- This indicator illuminates when Lane Keep Assist is turned on by pressing the Lane Keep Assist switch.
- While the Lane Keep Assist system is activated, if the vehicle travels across a lane marker, the indicator turns from white to green.

⇒ Refer to page 57.

## ■ Vehicle Dynamics Control warning light





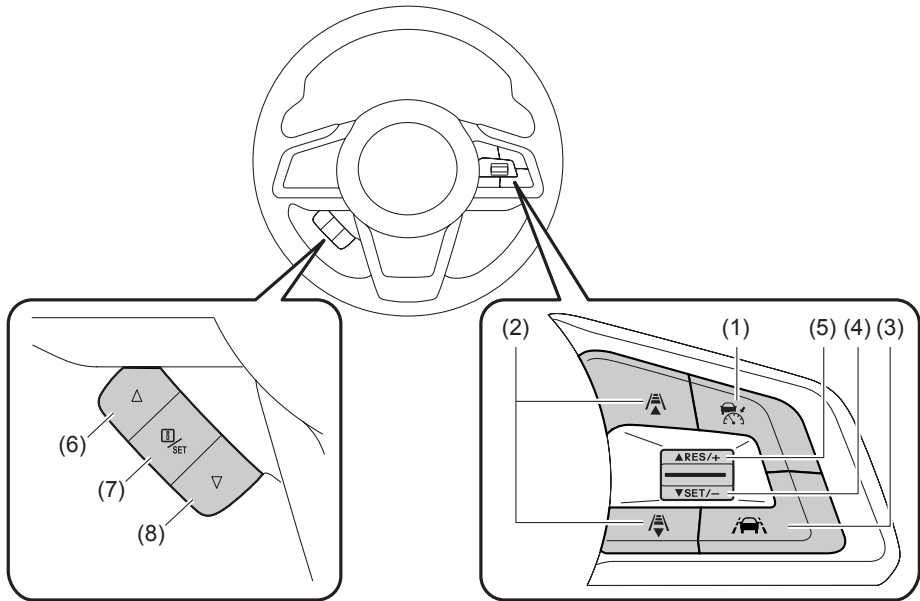

This warning light illuminates when the ignition switch is turned to the ON position, and turns off approximately 2 seconds after the engine is started. It will illuminate if there is a malfunction in the Vehicle Dynamics Control electrical control system.

⇒ Refer to the Owner's Manual for details.







## Switch layout



S02653

- |   |  |
|---|--|
| (1)  (CRUISE) switch   | (5) RES/+ switch   |
| (2)  /  (Following distance setting) switch | (6)  switch             |
| (3)  (Lane Keep Assist) switch  | (7)  (Info)/SET switch |
| (4) SET/- switch  | (8)  switch           |

## ■ (CRUISE) switch

- Switches cruise control\* on/off.
- When the  (CRUISE) switch is pressed, " " appears on the EyeSight display area in the combination meter display, and then  appears by pressing and holding the  /  (following distance setting) switch for approximately 2 seconds. When " " or " " is shown on the EyeSight display, this indicates that the main cruise control is on.

⇒ Refer to pages 39 and 75.

- This switch can be used to cancel the cruise control.

⇒ Refer to pages 47 and 80.

\* Adaptive Cruise Control and Conventional Cruise Control

## ■ RES/SET switch

### ● SET/-

- This switch can be used to set cruise control\*.
- This switch can be used to reduce the set vehicle speed (when cruise control\* is currently set).

⇒ Refer to pages 40 and 44 (for Adaptive Cruise Control).

⇒ Refer to pages 77 and 79 (for Conventional Cruise Control).

\* Adaptive Cruise Control and Conventional Cruise Control

### ● RES/+

- This switch can be used to set cruise control\*.
- After cruise control\* is canceled, this switch can be used to resume the cruise control function at the vehicle speed that was previously set.
- This switch can be used to increase set vehicle speed (when cruise control\* is currently set).

⇒ Refer to pages 43 and 50 (for Adaptive Cruise Control).



⇒ Refer to page 83 (for Conventional Cruise Control).

\* Adaptive Cruise Control and Conventional Cruise Control

## ■ / (Following distance setting) switch

- This switch can be used to switch the set following distance in 4 stages: (only when Adaptive Cruise Control is on).

⇒ Refer to page 46.

- When the  (CRUISE) switch is on, switching between Adaptive Cruise Control and Conventional Cruise Control is possible by pressing the  /  (Following distance setting) switch\*.

\* To switch to Conventional Cruise Control, press and hold the switch for approximately 2 seconds or longer.

## ■ (Lane Keep Assist) switch

Switches Lane Keep Assist on/off.

⇒ Refer to page 57.

## ■ ▲ switch/ ▼ switch

These switches are used in the following situations.

- When switching the screen displayed on the combination meter display.
- When changing the Warning Volume settings, etc.

⇒ Refer to page 90.

## ■ ⓘ (Info)/SET switch

This switch is used in the following situations.

- When displaying the message that appeared in the warning screen area again.

⇒ Refer to page 92.

- When changing the Warning Volume settings, etc.

⇒ Refer to page 90.

## ■ ❌ (Pre-Collision Braking System OFF) switch

Press and hold this switch for approximately 2 seconds or longer to turn off the Pre-Collision Braking System and Pre-Collision Throttle Management.

When these functions are off, the Pre-Collision Braking System OFF indicator light on the instrument panel illuminates.

Press and hold the switch again to turn on the Pre-Collision Braking System and Pre-Collision Throttle Management. This turns off the Pre-Collision Braking System OFF indicator light.

⇒ Refer to page 31.

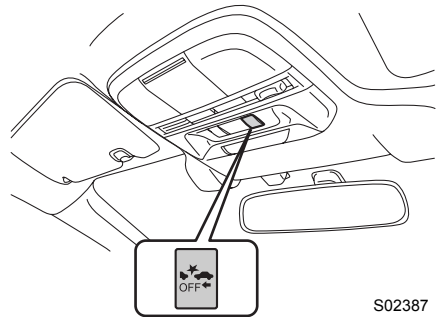

S02387

## ■ ❌ (Lane Departure Warning OFF) switch

Press and hold this switch for approximately 2 seconds or longer to turn off the Lane Departure Warning and Lane Sway Warning functions.

When these functions are off, the Lane Departure Warning OFF indicator light on the instrument panel illuminates.

Press and hold the switch again to turn on the Lane Departure Warning and Lane Sway Warning functions. This turns off the Lane Departure Warning OFF indicator light.

⇒ Refer to page 69.

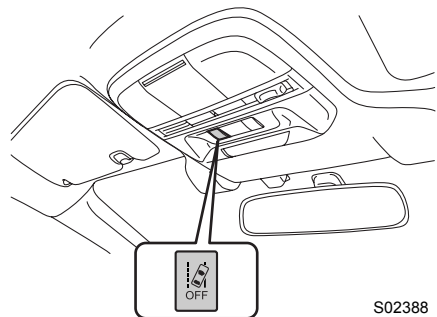

S02388

## Multi-function display

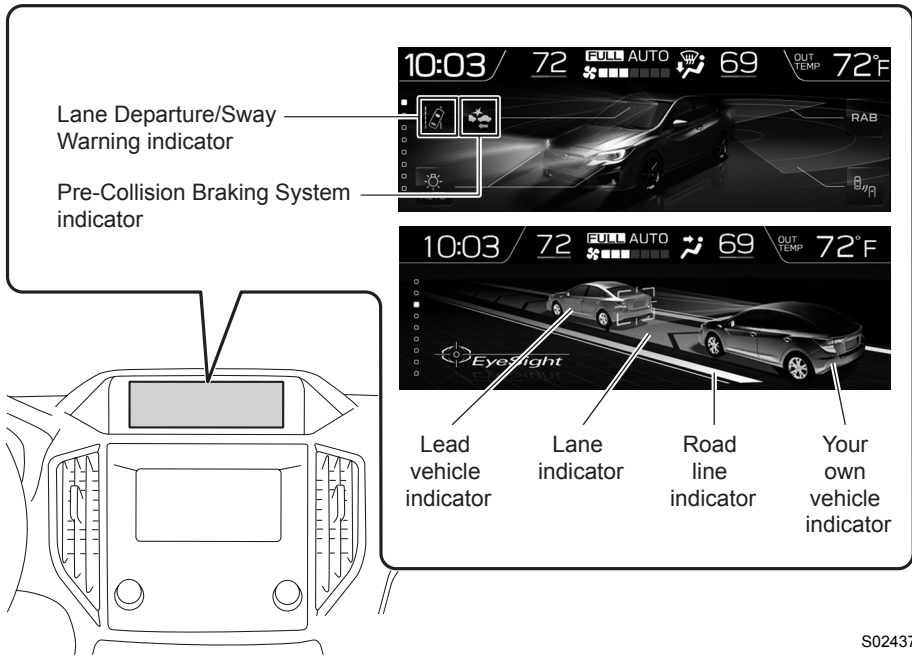

S02437

### ● Lane Departure/Sway Warning indicator

This indicator illuminates when the Lane Departure Warning and Lane Sway Warning are ON.

### ● Pre-Collision Braking System indicator

This indicator illuminates when the Pre-Collision Braking System is ON.

### ● Your own vehicle indicator

When the brake pedal is depressed or the brake control function is activated, the brake light on the vehicle indicator illuminates in red.

### ● Lead vehicle indicator

When the Adaptive Cruise Control is ON, and a vehicle is in front of you, the lead vehicle indicator is displayed. The lead vehicle indicator displays an image of the distance between your vehicle and the vehicle in front of you.

### ● Lane indicator

This indicator is displayed when the Lane Keep Assist is active.

### ● Road line indicator

This indicator illuminates when the Lane Keep Assist is operational or operating.

# Pre-Collision Braking System

When there is the risk of a rear-end collision with an obstacle in front, the EyeSight system helps to prevent or minimize a collision by warning the driver. If the driver still does not take evasive action to avoid a collision, the brakes can be automatically applied just before the collision in order to reduce impact damage, or if possible, prevent the collision. If the driver takes evasive action to avoid a collision, Pre-Collision Brake Assist will operate in order to help the driver to prevent or minimize the collision.

This system can be effective not only with direct rear-end collisions, but also with offset rear-end collisions. This function can be activated when the select lever is in the **[D]**, **[M]** or **[N]** positions.



- Never use the Pre-Collision Braking System and Pre-Collision Brake Assist to stop your car or avoid a collision under ordinary conditions. These functions cannot prevent collisions under all conditions. If the driver relies only on the Pre-Collision Braking System for Brake operation, collisions may occur.
- When a warning is activated, pay attention to the front of the vehicle and its surroundings, and operate the brake pedal and/or take other actions if necessary.
- The EyeSight Pre-Collision Braking System is primarily designed to prevent rear-end collisions with other vehicles when possible or to minimize damage and injuries in the event of a collision. In addition to other vehicles, things such as motorbikes, bicycles and pedestrians can also be treated as obstacles. However, there may be cases when detection is not possible depending on a variety of conditions<sup>\*2</sup>. For example, when a vehicle is viewed from the side, oncoming vehicle, vehicles approaching in reverse, small animals or children, or walls or doors are not likely to be detected.
- The Pre-Collision Braking System will operate at the point when it determines that a collision cannot be avoided and is designed to apply strong braking force just before a collision. The result of this varies depending on a variety of conditions<sup>\*2</sup>. Because of this, performance of this function will not always be the same.
- When the Pre-Collision Braking System is activated, it will continue to operate even if the accelerator pedal is partially depressed. However, it will be canceled if the accelerator pedal is suddenly or fully depressed.
- If the driver depresses the brake pedal or turns the steering wheel, the system may determine that this constitutes evasive action by the driver, and the automatic braking control may not activate in order to allow the driver full control.
- When the difference in speed with the obstacle in front is the following figure<sup>\*1</sup> or more, it may not be possible to avoid a collision. Even if the speed difference is the following figure<sup>\*1</sup> or less, in cases such as when another vehicle cuts in front of you, or in other cases depending on visibility, the condition of road surface and other factors<sup>\*2</sup>, the function may be unable to stop the vehicle or may not activate. Pre-Collision Brake Assist also may not activate depending on the conditions<sup>\*2</sup> listed below.

\*1: For vehicles: approximately 30 MPH (50 km/h),

For pedestrians: approximately 20 MPH (35 km/h)

\*2: Conditions

- Distance to obstacle in front of you, speed difference, proximity conditions, lateral displacement (the amount of offset)
- Vehicle conditions (amount of load, number of occupants, etc.)
- Road conditions (grade, slipperiness, shape, bumps, etc.)
- When visibility ahead is poor (rain, snow, fog or smoke, etc.)

Continued on next page ⇒

⇒ Continued from previous page

- When the detected object is something other than a vehicle, motorcycle, bicycle or pedestrian
  - A domestic animal or other animal (a dog or deer, etc.)
  - A guardrail, telephone pole, tree, fence or wall, etc.
- Even if the obstacle is a motorcycle, bicycle or pedestrian, depending on the brightness of the surroundings as well as the relative movement, and aspect or angle of the object, there may be cases when the system cannot detect it.
- When the system determines that operation by the driver (based on accelerator pedal operation, braking, steering wheel angle, etc.) is intended as evasive action
- Vehicle maintenance status (brake systems, tire wear, tire pressure, whether a temporary spare tire is being used, etc.)
- When towing a trailer or another vehicle, etc.
- When the brakes are cold due to outside temperature being low or just after starting the engine.
- When the brakes are overheated on downhill grades (braking performance is reduced)
- When driving in rain or after washing the vehicle (the brakes are wet and braking performance is reduced)
- Recognition conditions of the stereo camera  
In particular, the function may be unable to stop the vehicle or may not activate in the following cases.
  - Bad weather (for example heavy rain, a blizzard or thick fog)
  - When visibility is poor due to sand, smoke or water vapor blowing in the wind, or when the front vision is obscured due to water splashes, snow, dirt or dust stir up generated by the vehicle in front or oncoming traffic
  - When driving at night or in a tunnel without the headlights on
  - When driving at night or in a tunnel when there is a vehicle in front that does not have its taillights on
  - When approaching a motorcycle, bicycle or pedestrian at night
  - When ambient light is poor in the evening or early morning
  - When a vehicle, motorcycle, bicycle or pedestrian is outside the area illuminated by the headlights
  - When affected by strong light from the front (for example, sunlight at dawn, sunset or headlight beams, etc.)
  - When the windshield has become fogged, scratched, or snow, dirt, dust or frost has adhered to it, or it is otherwise affected.
  - When fluid has not been fully wiped off the windshield during or after washer use
  - When the target cannot be correctly recognized because the stereo camera's view is obstructed by water droplets from rain or the window washer, or by the wiper blades.
  - When the stereo camera's field of view is obstructed (for example by a canoe on the roof of the vehicle)

- When the rear aspect of the vehicle in front is low, small or irregular (the system may recognize another part of the vehicle as its rear and will determine operation from that)

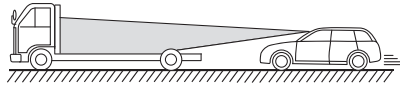

- When there is an empty truck or trailer with no rear and/or side panels on the cargo bed
- With vehicles that have cargo protruding from their back ends
- With non-standard shaped vehicles (vehicle transporters or vehicles with a sidecar fitted, etc.)
- When the height of the vehicle is low, etc.

S02133

- When there is a wall, etc. in front of a stopped vehicle
- When there is another object near the vehicle
- When a vehicle, etc. has its side facing you.
- With vehicles that are backing up or with oncoming vehicles, etc.
- When the size and height of an obstacle is smaller than the limitations of the stereo camera's recognition capability
  - With small animals or children, etc.
  - With pedestrians who are sitting or lying down

- When the detected object is a fence or wall, etc. with a uniform pattern (a striped pattern or brick pattern, etc.)

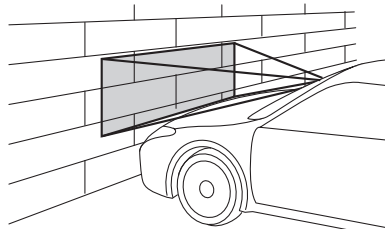

S00653

- When there is a wall or door made of glass or a mirror in front
- When the vehicle in front suddenly swerves, accelerates, or decelerates.
- When a vehicle, motorcycle, bicycle or pedestrian suddenly cuts in from the side or suddenly runs in front of you.
- When you suddenly change lanes and your vehicle is immediately behind an obstacle
- When there is a vehicle, motorcycle, bicycle or pedestrian in a location close to your vehicle's bumper
- When the speed difference between your vehicle and an obstacle is 5 MPH (5 km/h) or less (As braking is performed once the obstacle is in close proximity to your vehicle, depending on the shape and size of the obstacle, there may be some cases when the obstacle is outside the range of the camera's field of view.)

Continued on next page ⇒



⇒ Continued from previous page

- When driving on sharp curves, steep uphill grades or steep downhill grades
  - When driving on a bumpy or unpaved road
  - When there are changes in brightness, such as at a tunnel entrance or exit
  - Do not test Pre-Collision Braking System on its own. It may operate improperly and cause an accident.
  - The system may not operate correctly under the conditions listed below. When these conditions occur, turn off the Pre-Collision Braking System.
    - The tire pressure is not correct.\*1
    - The temporary spare tire is installed.\*1
    - Tires that are unevenly worn or tires with uneven wear patterns are installed.\*1
    - Tires that are the wrong size are installed.\*1
    - Flat tires that have been fixed temporarily with a tire repair kit.
    - The suspension has been modified (including a genuine SUBARU suspension that has been modified).
    - Any object that obstructs the stereo camera's view is installed on the vehicle.
    - The headlights are dirty or they have snow and ice or dirt on them. (Objects are not correctly illuminated and are difficult to detect.)
    - The optical axes are not aligned correctly. (Objects are not correctly illuminated and are difficult to detect.)
    - The lights including headlights and fog lights have been modified.
    - Vehicle operation has become unstable due to an accident or malfunction.
    - The brake system warning light is illuminated in red.\*2
    - A heavy cargo is loaded onto or inside the vehicle.
    - The maximum number of occupants is exceeded.
    - The combination meter is not operating properly; such as when the lights do not illuminate, the beeps do not sound, the display is different from when it is normal, etc.\*3
- \*1: The wheels and tires have functions that are critically important. Be sure to use the correct ones. For details, refer to the Owner's Manual for your vehicle.
- \*2: If the brake system warning light does not turn off, immediately pull the vehicle over in a safe place and contact a SUBARU dealer to have the system inspected. For details, refer to the Owner's Manual for your vehicle.
- \*3: For details about the combination meter, refer to the Owner's Manual for your vehicle.

**CAUTION**

- In the following situations, turn off the Pre-Collision Braking System. Otherwise the Pre-Collision Braking System may activate unexpectedly.
  - When the vehicle is being towed
  - When loading the vehicle onto a carrier
  - When a chassis dynamometer, free-rollers or similar equipment is used
  - When a mechanic lifts up the vehicle, starts the engine and spins the wheels freely
  - When passing hanging banners, flags or branches, or when thick/tall vegetation is contacting the vehicle
  - When using a drive-through car wash

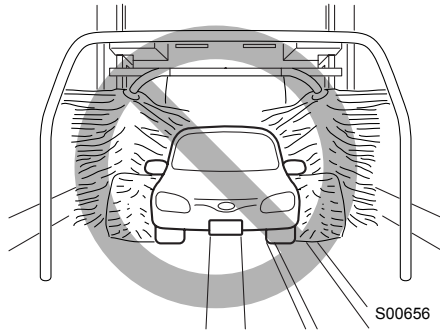

- The Pre-Collision Braking System may activate in the following situations. Therefore concentrate on safe driving.
  - When passing through an automatic gate (opening and shutting)
  - When driving close to the vehicle in front
  - When driving in a location where the grade of the road changes rapidly

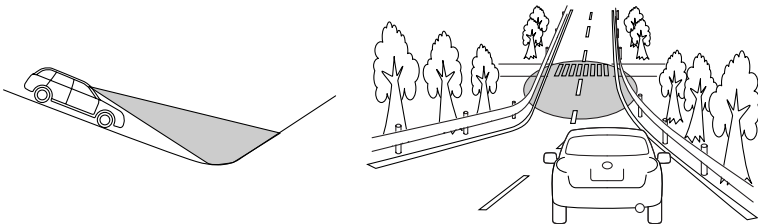

- When visibility is poor due to sand, smoke or water vapor blowing in the wind, or when the front vision is obscured due to water splashes, snow, dirt or dust stir up generated by the vehicle in front or oncoming traffic
- When passing through clouds of steam or smoke, etc.

Continued on next page ⇒

⇒ Continued from previous page

- When the exhaust gas emitted by the vehicle in front is clearly visible in cold weather, etc.

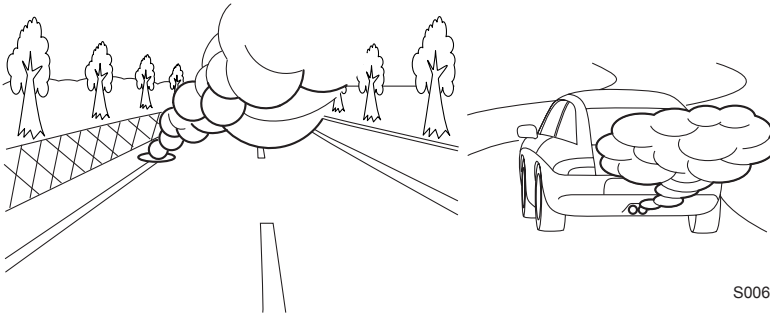

- When there is an obstacle on a curve or intersection
- When narrowly passing a vehicle or an object
- When stopping very close to a wall or a vehicle in front
- When passing through water spray from road sprinklers or snow clearing sprinklers on the road

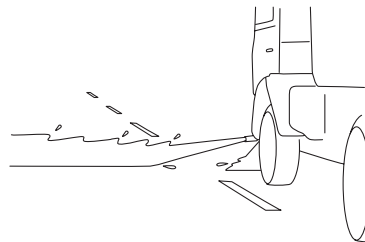
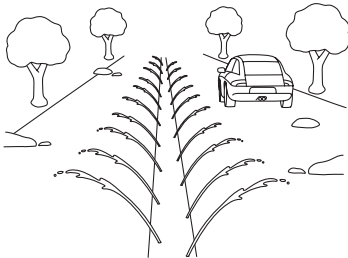
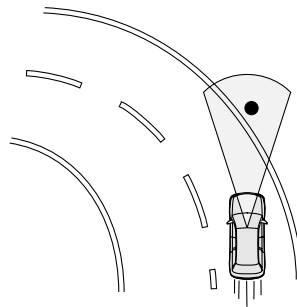

- If there is cargo or installed accessories, etc. that are protruding beyond the edge of the front bumper, the vehicle's length will increase and the system may not be able to prevent a collision.
- If the driver operates the brake pedal during automatic braking, the pedal may feel stiff; however, this is normal. By depressing the brake pedal further you can apply more braking force.

**NOTE**

Some unusual noises may be audible during automatic braking. This is caused by the braking control and is normal.

## ■ Detection of pedestrians

The EyeSight system can also detect pedestrians. The EyeSight system detects pedestrians from their size, shape and movement. The system detects a pedestrian when the contour of the head and shoulders are clear.

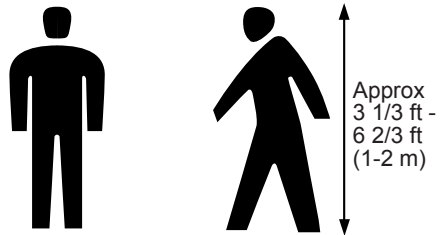

S00693

**WARNING**

The EyeSight system's Pre-Collision Braking function also identifies pedestrians as obstacles. However, depending on the conditions, there may be cases when the system cannot detect a pedestrian. In the following conditions, the possibility that the system may not be able to detect a pedestrian as an object is particularly high.

- When pedestrians are walking in a group
- When a pedestrian is next to a wall or other obstacle
- When a pedestrian is using an umbrella
- When a pedestrian is wearing clothes that are a similar color to the surrounding environment
- When a pedestrian is carrying bulky luggage
- When a pedestrian is bent over, crouching down or lying down
- When a pedestrian is in a dark location
- When a pedestrian suddenly crosses in front of you from the side or suddenly runs in front of you

## Pre-Collision Braking System operation

When there is an obstacle in front of you during driving, the system activates in the following sequence in order to warn the driver, activate braking control, and activate the brake lights.

### **Following Distance Warning:**

When the system determines that there is a risk of collision, a buzzer sounds repeated short beeps and the indicators on the combination meter display illuminate to warn the driver.

The Following Distance Warning operates when Adaptive Cruise Control is not set.

When the driver depresses the brake pedal to decelerate and achieves a suitable following distance, the warning is canceled.

### **First Braking and Warning:**

When the system determines that there is a high risk of collision with an obstacle in front, a buzzer sounds repeated short beeps and the indicators on the combination meter display illuminate to warn the driver. Braking control may be activated in some situations, the engine output may also be controlled. If the system determines that the amount of evasive action (braking, steering, etc.) taken by the driver has reduced the risk of collision, braking activation is canceled.

### **Secondary Braking and Warning:**

If the system then determines that the risk of collision is extremely high, the buzzer changes to a continuous beeping sound and stronger braking control is activated. Despite any evasive action taken by the driver, if the system subsequently determines that a collision is unavoidable, braking and engine output are controlled by the system.

Once the vehicle has come to a stop, the system will release the brake pedal control. At this time you will need to manually apply the brake.

### **Vehicle restart:**

When the vehicle is completely stopped by the automatic braking system, a short tone “3 short beeps and 1 long beep” will sound and braking will be gradually released and the vehicle will start creeping. To stop the vehicle completely, depress the brake pedal after the vehicle has stopped.

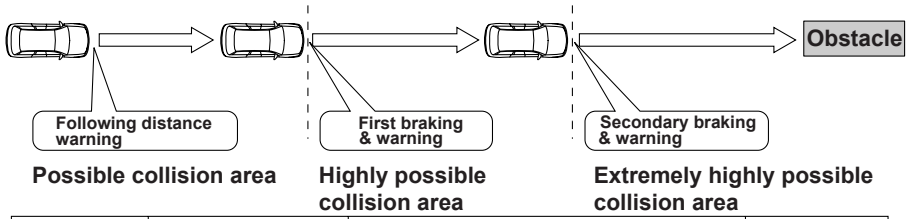

Operating system	Strength of Automatic Braking	Indication on the combination meter display	Warning buzzer type
Following distance warning	No brake control		Repeated short beeps
First braking	Moderate		Repeated short beeps
Secondary braking	Strong		Continuous beep

S02389



**NOTE**

- Neither first braking nor secondary braking will operate in the following cases.
  - When the vehicle speed is approximately 1 MPH (1 km/h) or less (When the select lever is in the **N** position and your vehicle speed is approximately 2 MPH (4 km/h) or less) or 100 MPH (160 km/h) or more
  - When Vehicle Dynamics Control is active
- If the system detects the brake lights of the vehicle in front, your vehicle will start decelerating earlier than if it does not.
- There are some cases where the first braking is applied for a longer period of time. One of the reasons for this is due to a large speed difference with an obstacle in front. In those cases, stronger or weaker braking control may be activated.

## Pre-Collision Braking Assist operation

When the Pre-Collision Braking System is activated (when the system determines that there is a high risk of collision with an obstacle in front), if the driver depresses the brake pedal, the system determines that this is emergency braking and activates braking assist automatically.

 **CAUTION**

If the driver depresses the brake pedal while following distance warning is activated, the Pre-Collision Braking Assist will not work. (The vehicle decelerates with the normal braking force operated by the driver.)

 **NOTE**

- Pre-Collision Braking Assist function does not operate when the vehicle speed is approximately 7 MPH (10 km/h) or less or 100 MPH (160 km/h) or more.
- For information about the braking assist function, refer to the Owner's Manual for your vehicle.

## Turning off the Pre-Collision Braking System

Press and hold the Pre-Collision Braking System OFF switch for approximately 2 seconds (or longer) to turn off the Pre-Collision Braking System (including Pre-Collision Brake Assist). When 1 short beep sound emits, this control is turned off and the Pre-Collision Braking System OFF indicator light on the instrument panel illuminates.

To turn the control back on, press and hold the Pre-Collision Braking System OFF switch for approximately 2 seconds or longer again. When this control is turned on, the Pre-Collision Braking System OFF indicator light turns off.

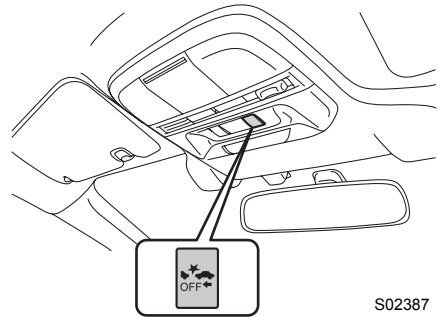

S02387



### NOTE

- When the Pre-Collision Braking System is turned off, the Pre-Collision Throttle Management Control function is also turned off.
- Even when the Pre-Collision Braking System is turned off, if the ignition switch is turned off and the engine is then restarted, the Pre-Collision Braking System will be turned on. The system default setting when the vehicle is restarted in "ON".



## ■ Pre-Collision Braking System OFF indicator light

This indicator light illuminates when the ignition switch is turned to the ON position, and remains illuminated for approximately 7 seconds after the engine starts. It turns on when the Pre-Collision Braking System is turned off. It also illuminates under the following conditions.

- When the EyeSight system has a malfunction  
⇒ Refer to page 86.
- When the EyeSight system has stopped temporarily  
⇒ Refer to page 88.

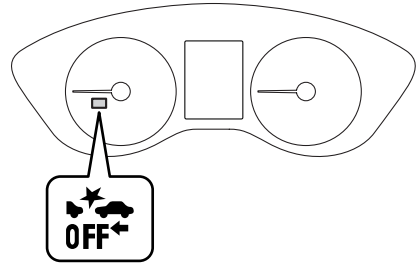

S02407



### NOTE

When the Pre-Collision Braking System OFF indicator light is turned on, the Pre-Collision Braking System (including the Pre-Collision Braking Assist function) does not operate.

# Adaptive Cruise Control

Adaptive Cruise Control is a driving support system intended to allow more comfortable driving on expressways, freeways and interstate highways. The stereo camera detects vehicles in front that are driving in the same traffic lane, and your vehicle follows the vehicle in front (up to the maximum speed of the set vehicle speed). While following, your vehicle will automatically maintain a following distance that corresponds to the speed of the vehicle in front. The vehicle is capable of being controlled at a speed between approximately 0 and 90 MPH (145 km/h). Please remember that you should not exceed posted speed limits.



## WARNING

- This system does not provide the driver with an automatic driving function that handles all traffic conditions.
- Do not rely excessively on Adaptive Cruise Control. This system is not intended to assist in driving when the driver is not paying full attention to what is ahead of him/her due to distractions or a lack of concentration while driving, or under conditions of poor visibility. It is not intended to prevent rear-end collisions.  
Strive for safe driving at all times. Always maintain a safe following distance behind the vehicle in front of you, pay attention to your surroundings and the driving conditions, and operate the brake pedal and take other action as necessary.
- Set the set vehicle speed within a range that is appropriate to the road conditions and surrounding environment.
- Before using the system, perform a daily inspection and verify that there are no malfunctions of the tires or brakes.  
⇒ Refer to the separate “Warranty and Maintenance Booklet”.
- The system may not operate correctly under the conditions listed below. When these conditions occur, do not use Adaptive Cruise Control.
  - The tire pressure is not correct.<sup>\*1</sup>
  - The temporary spare tire is installed.<sup>\*1</sup>
  - Tires that are unevenly worn or tires with uneven wear patterns are installed.<sup>\*1</sup>
  - Tires that are the wrong size are installed.<sup>\*1</sup>
  - Flat tires that have been fixed temporarily with a tire repair kit.
  - The suspension has been modified (including a genuine SUBARU suspension that has been modified).
  - Any object that obstructs the stereo camera’s view is installed on the vehicle.
  - The headlights are dirty or they have snow and ice or dirt on them. (Objects are not correctly illuminated and are difficult to detect.)
  - The optical axes are not aligned correctly. (Objects are not correctly illuminated and are difficult to detect.)
  - The lights including headlights and fog lights have been modified.
  - Vehicle operation has become unstable due to an accident or malfunction.
  - The brake system warning light is illuminated in red.<sup>\*2</sup>
  - A heavy cargo is loaded onto or inside the vehicle.
  - The maximum number of occupants is exceeded.
  - The combination meter is not operating properly; such as when the lights do not illuminate, the beeps do not sound, the display is different from when it is normal, etc.<sup>\*3</sup>

Continued on next page ⇒

⇒ Continued from previous page

- \*1: The wheels and tires have functions that are critically important. Be sure to use the correct ones. For details, refer to the Owner's Manual for your vehicle.
- \*2: If the brake system warning light does not turn off, immediately pull the vehicle over in a safe place and contact a SUBARU dealer to have the system inspected. For details, refer to the Owner's Manual for your vehicle.
- \*3: For details about the combination meter, refer to the Owner's Manual for your vehicle.
- Adaptive Cruise Control is designed for use on expressways, freeways, toll roads, interstate highways and similar limited access roads. It is not intended to be used in city traffic. In the following conditions, do not use Adaptive Cruise Control. Doing so may result in an accident.
  - Ordinary roads (roads other than those mentioned above)  
Depending on the driving environment (complexity of roads and other factors), the system may not be able to perform as the traffic conditions require, and that may result in an accident.
  - Sharp corners or winding roads
  - Frozen roads, snow-covered roads or other slippery road surfaces  
The tires may spin, causing loss of control of the vehicle.
  - Traffic conditions when frequent acceleration and deceleration make it difficult to maintain the following distance  
It may not be possible for the system to perform as the traffic conditions require.
  - Steep downhill grades  
The set vehicle speed may be exceeded.
  - On a steep continuous downhill grade  
The brakes may overheat.
  - Roads and overpasses with repeated steep uphill and downhill grades  
Detection of the vehicle in front may be lost, or the road surface may be detected instead of the vehicle in front, making correct control impossible.
  - When entering a sharp corner/turn into an interchange or junction, or a service area, parking area, toll booth or other facilities  
Detection of the vehicle in front may not be possible.
  - When there are changes in brightness, such as at a tunnel entrance or exit
  - When visibility is poor due to sand, smoke or water vapor blowing in the wind, or when the front vision is obscured due to water splashes, snow, dirt, water spray from road sprinklers or snow clearing sprinklers on the road, or dust stirred up generated by the vehicle in front or oncoming traffic.  
Detection of the vehicle in front may be lost, or water or other substances may be incorrectly detected instead, making correct control impossible.

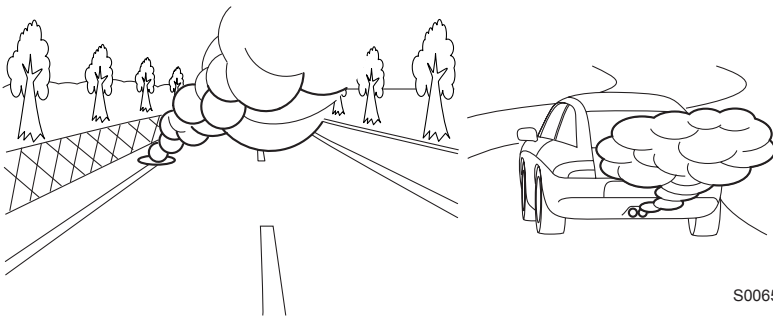

S00652

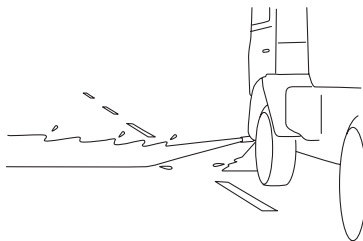
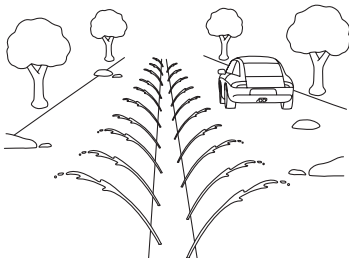

S02636

- When the windshield has become fogged, scratched, or snow, dirt, dust or frost has adhered to it, or it is otherwise affected.
- When water droplets from rain or the window washer, or dirt has not been fully wiped off the windshield  
It may not be possible to detect the vehicle in front, making correct control impossible.
- When the stereo camera's field of view is obstructed (for example by a canoe on the roof of the vehicle)
- The stereo camera may have difficulty detecting the following objects or conditions. Operate the brake pedal and take other actions as necessary.
  - Vehicles at significantly different speeds (vehicles driving slowly, stopped or oncoming vehicles, etc.)
  - Vehicles cutting into your lane
  - Motorcycles, bicycles, pedestrians and animals, etc.
  - When light is poor in the evening or early morning
  - When driving at night or in a tunnel without the headlights on
  - When driving at night or in a tunnel when there is a vehicle in front that does not have its taillights on
  - When affected by strong light from the front (sunlight or headlight high beams, etc.)
  - Vehicles in front that have a rear aspect that is low, small or irregular (the system may recognize another part of the vehicle and will determine operation from that)
    - An empty truck or trailer that has no tailgate or longbed
    - Vehicles that have cargo protruding from their back ends
    - Non-standard shaped vehicles (vehicle transporters or vehicles with a sidecar fitted, etc.)
    - Vehicles that are low
  - Objects that are located close to the bumper of your vehicle

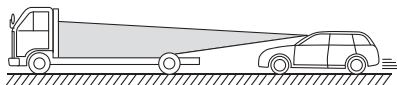

S02133

- When you do not want to use Adaptive Cruise Control, be sure to turn the  (CRUISE) switch off. If the switch is left on, cruise control may be accidentally engaged, possibly resulting in an accident.
- Before using Adaptive Cruise Control, be sure to fully verify the safety of the vehicle occupants and the area around the vehicle. Never operate the cruise control from outside the vehicle.

Continued on next page ⇒

⇒ Continued from previous page

### Detection of the vehicle in front by the EyeSight stereo camera\*

- Under the following road conditions or conditions of your vehicle, detection of the vehicle in front may not be possible. Vehicles in neighboring traffic lanes or roadside objects may also be incorrectly detected. Under conditions such as these, do not use Adaptive Cruise Control. If cruise control is currently in use, operate the brake pedal and take other action as necessary.

- When following begins from a short following distance, such as when the vehicle in front is a vehicle that cut into your lane

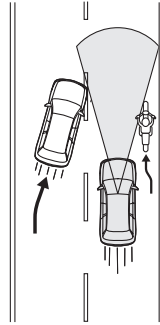

S01975

- When driving on curved roads, at the start and end of a curve and on roads with continuous curves (These conditions make it difficult for the system because they are outside the detectable area.)

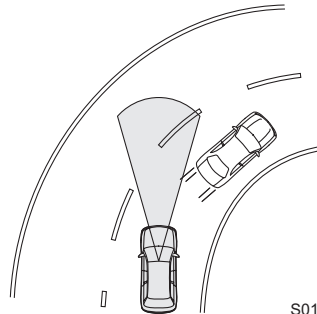

S01976

- When driving on an on-ramp or off-ramp to a freeway, highway, or other restricted access road (EyeSight Adaptive Cruise Control is not designed for use in this kind of driving environment.)
- When driving in an urban, or suburban environment (Adaptive Cruise Control is not appropriate for use in these driving areas. Use the Adaptive Cruise Control only on limited-access highways.)

- When the vehicle in front is not directly ahead of your vehicle and is shifted to one side

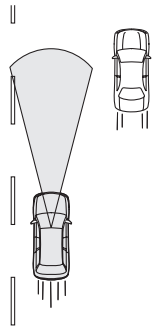

S01977

- When there is an obstacle at the side of the road
- When the relative speed difference compared to the vehicle in front is large
- When a vehicle cuts into your lane in front of you
- When the distance between vehicles is extremely short
- When your vehicle is drifting within the lane
- When driving on a bumpy or unpaved road surface
- When driving on a road with extremely narrow lanes, such as when traffic restrictions are in effect or in areas where construction work is taking place
- When normal driving has become unstable due to an accident or malfunction
- When extremely heavy cargo is loaded in the cargo area, rear seat or trunk of your vehicle

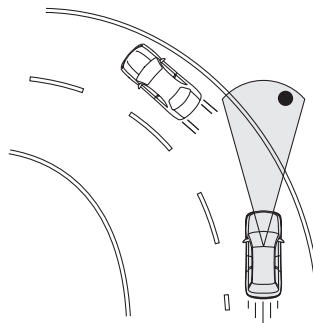

S01978

- There are limits to the situation judgment capabilities of the Adaptive Cruise Control system. Deceleration may not take place in time in the following situations. Apply the brake pedal to decelerate the vehicle if necessary.
    - When the speed difference with the vehicle in front is too large or the vehicle in front decelerates unexpectedly
    - When the decelerating vehicle in front unexpectedly slows down or suddenly brakes
  - If the buzzer sounds frequently, do not use Adaptive Cruise Control.
  - Even when the following distance is short, the "Obstacle Detected" warning may not activate in the following cases.
    - When the relative speed difference compared to the vehicle in front is small (the two vehicles are traveling at almost the same speed)
    - When the vehicle in front is traveling faster than your vehicle (the following distance is gradually increasing)
    - When another vehicle cuts into your lane very close to your vehicle
    - When the vehicle in front decelerated suddenly
    - When there are repeated uphill and downhill grades
- \*: The recognition status of the lead vehicle using the stereo camera can be confirmed by the illumination status of the lead vehicle indicator.  
(⇒ Refer to page 41.)

 **CAUTION**

- After Adaptive Cruise Control has started, it maintains control continuously according to the behavior of the vehicle in front. When your vehicle comes to a stop because the vehicle in front has stopped, the automatic braking function will be canceled immediately after stopping and the vehicle will start creeping forward gradually (at the same time three short beeps and a single long beep will sound). Be sure to depress the brake pedal and stop the vehicle completely.

Note that the vehicle is not maintained at a standstill position and will not automatically start moving from a standstill position.



- Braking may not be sufficient depending on the following conditions. Depress the brake pedal and decelerate as necessary.
  - Vehicle conditions (amount of load, number of occupants, etc.)
  - Road conditions (grade, slipperiness, shape, bumps, etc.)
  - Vehicle maintenance condition (brake systems, tire wear, air pressure, temporary spare tire is being used, etc.)
  - When the brakes are cold. (For example, just after the engine is started or when the outside temperature is low.)
  - For a short period of time when driving after the engine is started until the engine has warmed-up
  - When the brakes are overheated on downhill grades (braking performance may be reduced)
  - When driving in rain or after washing the vehicle (the brakes may become wet and braking performance may be reduced)
  - When towing a trailer or another vehicle, etc.

## How to use Adaptive Cruise Control

Adaptive Cruise Control is available when the engine is turned on.

### ■ Setting Adaptive Cruise Control

(1) Setting Adaptive Cruise Control to standby status

Press the  (CRUISE) switch. At this time, " " (Adaptive Cruise Control), your vehicle indicator and the following distance setting indicator are displayed on the EyeSight display area in the combination meter display.

The set vehicle speed display will read "-- MPH".

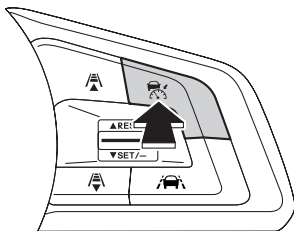

S02390

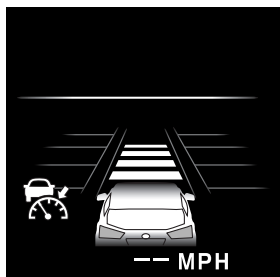

S02391

If the switch is pressed once more, the EyeSight display will turn off. It will also automatically turn off when the engine is stopped.

To set ready status:

Adaptive Cruise Control can be set when all of the following conditions are met and **READY** is displayed on the EyeSight display area.

- All doors (except the rear gate/trunk) are closed.
- The driver's seatbelt is fastened.
- The select lever is in the **D** or **M** position.
- The brake pedal is not depressed.
- EyeSight operation is not temporarily stopped.

⇒ Refer to page 88.

- The road is not a steep slope.
- The steering wheel has not been turned significantly in either direction.
- The vehicle speed is between approximately 0 MPH (0 km/h) and 90 MPH (145 km/h).
- Parking brake is released.

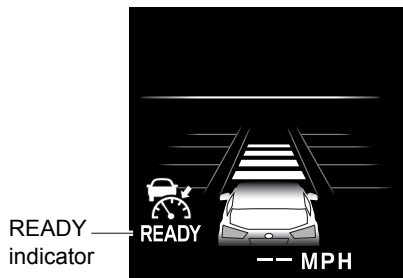

S02709



(2) Setting Adaptive Cruise Control

Press the RES/SET switch to “SET/-” or “RES/+”.

Adaptive Cruise Control is now set, and cruise control will start.

If no vehicle in front has been detected, the vehicle drives at the constant set target speed.

When Adaptive Cruise Control is set, the set speed is displayed and  changes from white to green.

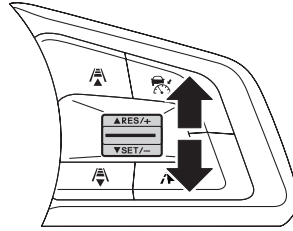



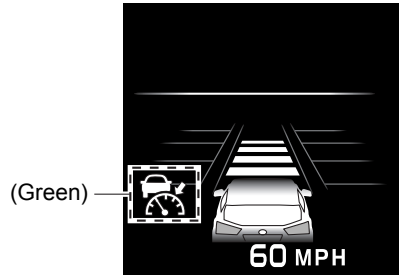

S02654





S02394



**NOTE**

- The target vehicle speed can be set between 20 MPH (30 km/h) and 90 MPH (145 km/h).
- If the vehicle speed is approximately 20 MPH (30 km/h) or less when the vehicle speed is set, the set vehicle speed is set to 20 MPH (30 km/h).
- When driving on a curve, the vehicle may not accelerate, or may decelerate, even if the set speed is higher than the current vehicle speed.
- If  does not illuminate, even when the  (CRUISE) switch is pressed, Adaptive Cruise Control will not operate.
- If  does not illuminate, even when the  (CRUISE) switch is pressed and this occurs frequently, there may be a malfunction in the system. Contact a SUBARU dealer and have the system inspected.

When a vehicle in front is detected, a buzzer sounds 1 short beep and the lead vehicle indicator will illuminate.

The vehicle follows the lead vehicle in front and maintains the selected following distance. At this time, the cruise speed is adjusted to and will not exceed the set speed. If the vehicle in front is no longer detected, a buzzer sounds 1 short beep and the lead vehicle indicator turns off. While the driver accelerates the vehicle by depressing the acceleration pedal,  (green) changes to white. When acceleration has stopped,  (white) changes to green.

Lead vehicle indicator

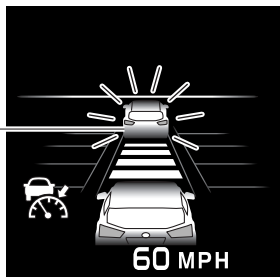

S02710



**NOTE**

The buzzer sound (lead vehicle acquisition sound) that occurs when a vehicle in front is detected or no longer detected while Adaptive Cruise Control is set can be turned off by customization.

⇒ Refer to page 90.

**Operation of Adaptive Cruise Control**

- When no vehicle in front is detected

The vehicle drives constantly and correspondingly to the set vehicle speed between 20 MPH (30 km/h) and 90 MPH (145 km/h).

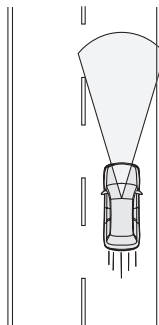

S01979

- When a vehicle in front is detected

The vehicle follows the lead vehicle in front, and will maintain the chosen following distance (there are four settings), up to the set target vehicle speed - between 20 MPH (30 km/h) and 90 MPH (145 km/h).

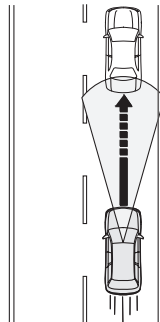

S01980

- If your vehicle no longer detects the vehicle in front

The vehicle gradually accelerates back to the set target vehicle speed and will drive at that constant speed.

If a vehicle in front is detected while accelerating to the set target vehicle speed, vehicle following will be started again.

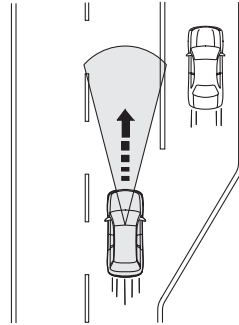

S01981

**CAUTION**

If the driver operates the brake pedal during automatic braking, the pedal may feel stiff; however, this is not a malfunction. By depressing the brake pedal further you can apply more braking force. When the brake pedal is released it will return to its original condition.

**NOTE**

- When the brakes are applied by Adaptive Cruise Control, the vehicle's brake lights will illuminate.
- Even if there is no lead vehicle present, on a downhill grade, the Adaptive Cruise Control's automatic brake may operate in order to maintain the set target vehicle speed.
- Some noises may be audible during automatic braking. This is caused by the braking control and does not indicate a malfunction.
- To temporarily accelerate quickly, use the accelerator pedal. After accelerating, the vehicle will gradually return to the set target vehicle speed shown in the set vehicle speed display.
- If the vehicle in front is no longer detected while your vehicle is still controlled by the automatic braking operation, the brake will be automatically released gradually. Depress the accelerator pedal if necessary.
- The lead-vehicle following function has the following characteristics:
  - If the lead vehicle's brake lights are detected, deceleration will start earlier than without detection.
  - If the vehicle moves to the fast lane while traveling more than 37 MPH (60 km/h), the system starts acceleration to the set vehicle speed more quickly because it is linked with the turn signal.

## ■ Increasing the set vehicle target speed

### ● Using the RES/SET switch

While driving with Adaptive Cruise Control on, operate the RES/SET switch as follows.

- Push to the “RES/+” side briefly.

Every time the switch is pushed, the set vehicle target speed will increase to the next 5 MPH (5 km/h) increment.

- Push to the “RES/+” side continuously.

While the switch is being pushed, the set vehicle target speed will increase by 1 MPH (1 km/h).

When operating the switch, the set vehicle target speed changes on the combination meter display.

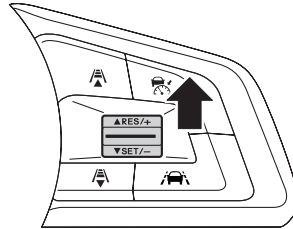

S02655

### ● Using the accelerator pedal

Depressing the accelerator pedal will increase vehicle speed. Once the preferred speed has been attained, push the RES/SET switch to SET/-. When the switch is pressed, the new vehicle target speed will be set. The new set vehicle speed will be displayed in the EyeSight display area.



#### CAUTION

- When Adaptive Cruise Control is operating, the actual vehicle speed is controlled according to the lead vehicle. Therefore, if the RES/SET switch is pressed to the “RES/+” and set to a speed higher than the speed of the lead vehicle, the vehicle will not accelerate - it will maintain a safe following distance as the first priority. However, because doing so changed the set vehicle target speed, when the lead vehicle is no longer detected (for example, if you change to a freeway lane with no vehicles in front), the vehicle will accelerate to that new set target speed. Change the set vehicle target speed while briefly checking the value shown in the set speed display on the EyeSight display.
- When the accelerator pedal is depressed with Adaptive Cruise Control on, automatic braking control and warnings by Adaptive Cruise Control will not occur. However, if there is a high risk of collision with an obstacle in front of the vehicle at this time, the warning and braking control of the Pre-Collision Braking System may activate.

## ■ Decreasing the set vehicle target speed

### ● Using the RES/SET switch

While driving with Adaptive Cruise Control on, operate the RES/SET switch as follows.

- Push to the “SET/-” side briefly.

Every time the switch is pushed, the set vehicle target speed will decrease in to the next 5 MPH (5 km/h) decrement.

- Push to the “SET/-” side continuously.

While the switch is being pushed, the set vehicle target speed will decrease by 1 MPH (1 km/h).

When operating the switch, the set vehicle target speed changes on the combination meter display.

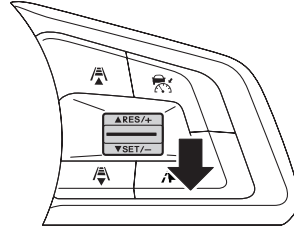

S02656



### ● Using the brake pedal

- (1) Depress the brake pedal to decrease the vehicle speed. (Adaptive Cruise Control will be canceled and  changes from green to white.)
- (2) When the desired speed is reached, press the RES/SET switch to the “SET/-”. The speed at the time of pressing the switch will be set as the new vehicle speed, and it appears in the EyeSight display area.

## ■ Accelerating temporarily

Depress the accelerator pedal to accelerate temporarily.

When the accelerator pedal is released, the vehicle returns to the set vehicle speed.

When the driver accelerates the vehicle by depressing the acceleration pedal while the Adaptive Cruise Control is operating,  turns white. When the acceleration is completed,  returns to green.

## ■ Decelerating temporarily

Depress the brake pedal to decelerate temporarily. When the brake pedal is depressed, Adaptive Cruise Control will be canceled. The  changes from green to white while the set vehicle target speed remains displayed on the EyeSight display area.

Release the brake pedal and press the RES/SET switch to “RES/+” to reset the set vehicle target speed.

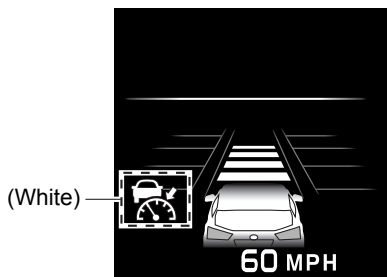



S02397

### CAUTION

Ordinarily, while Adaptive Cruise Control is functioning, acceleration and deceleration are performed automatically in accordance with the speed of the lead vehicle (if one is detected). However, when your vehicle approaches a lead vehicle, for example if it is necessary to accelerate for a lane change or other reason, and if the vehicle in front suddenly decelerates, or if another vehicle cuts into your path, operate the accelerator pedal or brake pedal to accelerate or decelerate as appropriate for the existing conditions.

## ■ Changing the following distance from the vehicle in front

The following distance from the vehicle in front setting can be changed in 4 stages.

-  : When the switch (▲ side) is pressed, the following distance will be longer.
-  : When the switch (▼ side) is pressed, the following distance will be shorter.

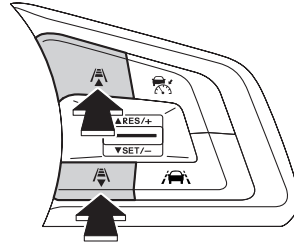





S02657



### NOTE

- The following distance changes corresponding with the vehicle speed. The faster the vehicle travels, the greater the following distance.

#### <Approximate guide to following distances>

Following distance indicator	When your vehicle speed is 25 MPH (40 km/h)	When your vehicle speed is 60 MPH (100 km/h)
	Approx. 95 ft (30 m)	Approx. 190 ft (60 m)
	Approx. 80 ft (25 m)	Approx. 160 ft (50 m)
	Approx. 65 ft (20 m)	Approx. 130 ft (40 m)
	Approx. 50 ft (15 m)	Approx. 100 ft (30 m)

- The following distance previously set is restored when you turn back on the  (CRUISE) switch.

# ■ Canceling Adaptive Cruise Control

## ● Canceling by driver operation

Either of the following operations will cancel Adaptive Cruise Control.

- Depress the brake pedal.

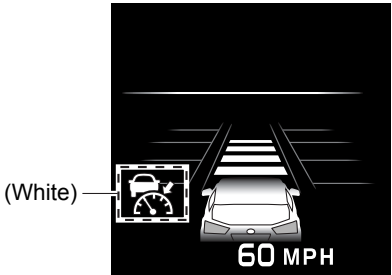

 changes from green to white while the set vehicle target speed remains displayed on the EyeSight display area.



S02397

- Press the  (CRUISE) switch.

 changes from green to white while the set vehicle target speed remains displayed on the EyeSight display area.

When the  (CRUISE) switch is pressed again,  will be turned off and Adaptive Cruise Control will be turned off.

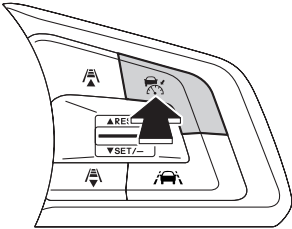

S02390



## ● Automatic cancellation by the system

In the following cases, a buzzer will sound 1 short beep and 1 long beep and Adaptive Cruise Control is automatically canceled.

 changes from green to white. Also, the Adaptive Cruise Control cancellation message is displayed on the screen.

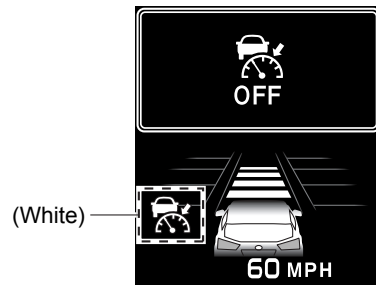

S02399

### • Conditions for automatic cancellation

- The grade of the road is very steep.
- The Vehicle Dynamics Control or the Traction Control Function is activated.
- The vehicle speed has exceeded approximately 100 MPH (160 km/h) while cruise control is set.
- The steering wheel was turned significantly in either direction.
- The transmission select lever is moved to a position other than **D** or **M**.
  - Adaptive Cruise Control can be resumed after the transmission select lever is returned to the **D** or **M** position.
- Any door (except the rear gate/trunk) is opened.
- The driving wheels spin on a slippery road.
- The driver's seatbelt is unfastened.
- EyeSight operation has temporarily stopped.

⇒ Refer to page 88.

- EyeSight is malfunctioning.

⇒ Refer to page 86.

- The Pre-Collision secondary braking has activated.
- Parking brake is applied.

**WARNING**

Do not use Adaptive Cruise Control on slippery roads. Doing so may result in an accident.

**CAUTION**

When shifting the select lever to the **[N]** position, Adaptive Cruise Control will be automatically canceled. Do not shift the lever to the **[N]** position unless it is an emergency. Otherwise the engine brake may not operate, which could cause an accident.

**NOTE**

- If EyeSight operation has temporarily stopped, the Pre-Collision Braking System OFF indicator light and Lane Departure Warning OFF indicator light illuminate, and the EyeSight temporary stop indicator is displayed on the combination meter display.  
⇒ Refer to page 88.
- If EyeSight is malfunctioning, the EyeSight warning indicator is displayed on the combination meter display, and the Pre-Collision Braking System OFF indicator light and Lane Departure Warning OFF indicator light will also illuminate. If this occurs, stop the vehicle in a safe location and then turn off the engine and restart it. If the indicators remain illuminated after restarting the engine, Adaptive Cruise Control cannot be used. This will not interfere with ordinary driving; however the system should be inspected by a SUBARU dealer as soon as possible.  
⇒ Refer to page 86.
- When the operation of Adaptive Cruise Control has been automatically canceled, perform the Adaptive Cruise Control setting operation again after the condition that caused the cancellation has been corrected. If the Adaptive Cruise Control function cannot be set even after the condition has been corrected, EyeSight may be malfunctioning. This will not interfere with ordinary driving; however contact a SUBARU dealer and have the system inspected.

## ■ Returning to a vehicle speed that was previously set

The vehicle speed which was previously set is stored in memory.\* To return to set that vehicle speed, press the RES/SET switch to the RES/+. (When  changes from white to green, the system will return to the set condition.)

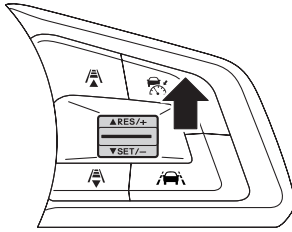

S02655

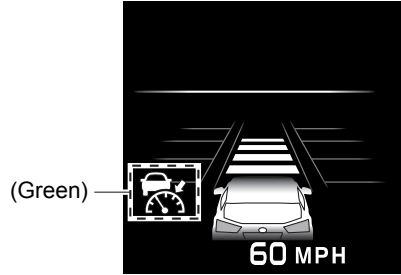

S02394



### NOTE

\*The vehicle speed stored in memory is erased in the following circumstances:

- The cruise control is turned off by pressing the  (CRUISE) switch.
- Vehicle Dynamics Control or Traction Control Function are activated.
- The cruise control mode was switched from Adaptive Cruise Control to Conventional Cruise Control.

## Other functions

### ■ “Obstacle Detected” warning

The “Obstacle Detected” warning is activated while Adaptive Cruise Control is following a lead vehicle. This function warns the driver when it determines that the current level of deceleration by automatic braking control is insufficient.

- When the system determines that the vehicle speed needs to be reduced manually by the driver, the “Obstacle Detected” warning will be displayed in the combination meter display and a warning buzzer will sound several short beeps.
- When this function activates, depress the brake pedal to decelerate and maintain an optimal following distance.



S02401



#### WARNING

- If the buzzer sounds frequently, do not use Adaptive Cruise Control.
- The “Obstacle Detected” warning will not activate in the following situations.
  - The accelerator pedal is depressed.
  - The brake pedal is depressed.
- Even when the following distance is short, the “Obstacle Detected” warning may not activate in the following situations.
  - The difference in speed with the vehicle in front is small. (The two vehicles are traveling at almost the same speed.)
  - The vehicle in front is traveling faster than your vehicle. (The following distance is gradually increasing.)
  - Another vehicle cuts into your lane very close to your vehicle.
  - The vehicle in front decelerates suddenly.
  - When there are repeated uphill and downhill grades
- The “Obstacle Detected” warning may not activate in time in the case of a vehicle that is stopped at the end of a line at a toll gate, at a stop light or intersection or in traffic congestion, or a vehicle that is moving much slower than your vehicle. EyeSight requires a speed differential in order to recognize a potential obstacle and react to it.



**CAUTION**

The automatic braking function is released gradually approximately 2 seconds after stopping and the vehicle starts creeping forward. Be sure to depress the brake pedal and stop the vehicle completely.



**NOTE**

Vehicles in front in the same traffic lane are detected by the stereo camera within a distance of approximately 360 ft (110 m) in the forward direction. However the detection distance may be reduced depending on the traffic environment, driving conditions, and conditions of the vehicle in front.

# Lane Keep Assist

The stereo camera detects lane markings (including Botts' dots) of the lane and the system assists the steering operation by working with the electric power steering to help keep your vehicle in its lane when driving on expressways, freeways and interstate highways.

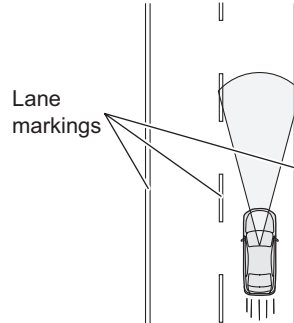

S01892



## WARNING

**Lane Keep Assist is not an automatic driving system.**

**Do not overestimate the capabilities of Lane Keep Assist. It is not a system to assist inattentive driving or meant to permit driving without holding the steering wheel. Make sure to grip the steering wheel while driving. To drive safely, check the distance from the vehicle in front or from a vehicle driving in parallel with your vehicle, the surrounding conditions and the surrounding environment while driving.**

If you feel that the level of control and timing by the system are different from your own driving style, the system may not support safe driving. Do not use Lane Keep Assist.

Lane Keep Assist does not always operate under all situations. If you rely only on the Lane Keep Assist to stay in a lane, it may cause an accident such as a collision with an obstacle beside your lane or with a vehicle driving in an adjacent lane.

- Check that there are no problems with the tires and brakes during a daily inspection before using the system.
- ⇒ Refer to “Warranty and Maintenance Booklet”.
- The system may not operate properly under the following conditions. Do not use Lane Keep Assist.
  - The air pressure of tires is not to specification.\*1
  - Tires that are unevenly worn or tires with uneven wear patterns are installed.\*1
  - Tires that are the wrong size are installed.\*1
  - The wheels are out of balance (e.g., the balance weight is removed or misaligned).\*1
  - The wheels are out of alignment.\*1
  - Flat tires that have been fixed temporarily with a tire repair kit.
  - The suspension has been modified (including genuine SUBARU parts).
  - Any object that obstructs the stereo camera’s view is installed on the vehicle.

Continued on next page ⇒

⇒ Continued from previous page

- Tire chains are installed.
- When you feel an abnormal vibration in the steering wheel or feel the steering wheel is heavier than usual.
- The steering wheel has been replaced with parts other than genuine SUBARU parts.
- The headlights are dirty or they have snow, ice or dirt on them. (Objects are not adequately illuminated and are difficult to detect.)
- The headlights are not aligned correctly. (Objects are not adequately illuminated and are difficult to detect.)
- The headlights, fog lights and other lights have been modified.
- Vehicle operation has become unstable due to an accident or malfunction.
- The brake system warning light (red) is illuminated.\*<sup>2</sup>
- A heavy cargo is loaded onto or inside the vehicle.
- The maximum number of occupants is exceeded.
- Your vehicle is towing a vehicle, etc.
- The combination meter is not operating properly. For example, an indicator light or a warning light in the combination meter does not properly turn on or off, a beep does not sound, or the indication on the liquid-crystal display is different from when it is normal.\*<sup>3</sup>

\*1: The wheels and tires have critically important functions. Be sure to use the appropriate ones.

For details, refer to the Owner's Manual for your vehicle.

\*2: If the brake system warning light does not turn off, immediately pull the vehicle over in a safe place and contact a SUBARU dealer to have the system inspected. For details, refer to the Owner's Manual for your vehicle.

\*3: For details about the functions and operations of the combination meter, refer to the Owner's Manual for your vehicle.

- Lane Keep Assist is designed for use on expressways, freeways, toll roads, interstate highways and similar limited access roads. In the following conditions, do not use Lane Keep Assist. Doing so may result in an accident.

- Ordinary roads (roads other than those mentioned above)
- Roads with sharp corners
- Roads with lane restrictions or tentative lanes due to construction work, etc.
- Old lane markings remain.
- Snow, puddles or snow melting agents remain on the road surface.
- Cracks or constructed traces remain on the road surface.

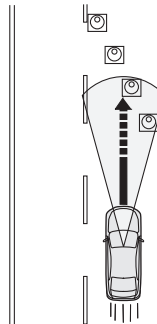



S01893

- Frozen roads, snow-covered roads or other slippery road surfaces  
The tires may spin, causing loss of control of the vehicle.
- When entering a sharp curve into an interchange or junction, or a service area, parking area, toll booth or other facilities.
- When there are changes in brightness, such as at a tunnel entrance or exit.
- When visibility is poor due to sand, smoke or water vapor blowing in the wind, or when the front vision is obscured due to water splashes, snow, dirt or dust stir up generated by the vehicle in front or oncoming traffic.
- When the windshield has become fogged, scratched, or snow, dirt, dust or frost has adhered to it, or it is otherwise affected.
- When rain or dirt has not been fully wiped off of the windshield, there is a risk of that the stereo camera may not detect the lanes.
- When the stereo camera's field of view is obstructed (for example by a canoe on the roof of the vehicle).
- The stereo camera may have difficulty detecting the objects under the following conditions and the system may not operate properly.
  - When driving at night or in a tunnel without the headlights on.
  - When light is poor in the evening or early morning.
  - In bad weather (for example, rain or snow)
  - The distance between your vehicle and the vehicle in front is short, making it difficult to detect lane markings.
  - When a vehicle intruded from an adjacent lane or the vehicle in front changed lanes.
  - The shape of a curve in the road suddenly changes.
  - Shadows of guardrails or similar objects are overlapped on the lane markings.
  - When your vehicle is exposed to a strong light from the front (backlight from the sun, headlights, etc.).
  - The width of a lane is narrow.
  - The stereo camera may have difficulty detecting the lane due to the performance of the camera.
    - There are no lane markings or they are very worn.
    - The lane markings are painted in yellow.
    - It is difficult to detect lane markings because they are similar in color to the road surface.
    - The lane markings are drawn in double.
    - The width of lane markings is narrow.
    - The indicated lines for the area are touched to walls and poles.
  - The shape of lane markings suddenly changes (entrance/exit of a curve, crank and S-shaped road, etc.).
  - There is curb or side wall in the road shoulder.
  - The brightness changes such as when you drive under an overpass.



 **CAUTION**

- The performance of Lane Keep Assist may not be optimal under the following conditions. In addition, Lane Keep Assist may not operate or the operation may be canceled.
  - Immediately after the weight of your vehicle changes radically
  - Immediately after the replacement of a tire or the adjustment of tire pressure
  - Immediately after the adjustment, repair or replacement of camera or related components
  - Immediately after the repair or replacement of the suspension or steering system
  - A winter tire or a tire other than a genuine SUBARU tire is used.
  - The vehicle is in a crosswind.
  - The road grade abruptly changes (uphill or downhill).
  - The grade of the crossing direction in a road is large or changes abruptly.
  - Unevenness, winding and joint of a road surface
  - The acceleration/deceleration is high.
  - Immediately after starting the engine when the outside temperature is low.
  - The outside temperature is high.
- When you do not use Lane Keep Assist, make sure to turn off the  (Lane Keep Assist) switch. If you turn it on, the function may operate unexpectedly, causing an accident.
- If you turn on the  (Lane Keep Assist) switch, the operation power of electric power steering may change.

## Lane Departure Prevention Function

The system detects lane markings in order to help prevent departure from the lane. If you drive on expressways, freeways or interstate highways at speeds above approximately 37 MPH (60 km/h) and the vehicle is about to depart from the lane, the system assists the steering operation by turning it to the direction that will help prevent the lane departure.

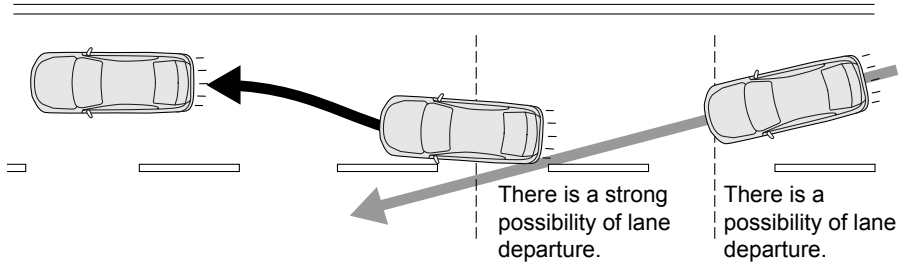

S01896

### ■ How to use Lane Departure Prevention Function

Press the  (Lane Keep Assist) switch.

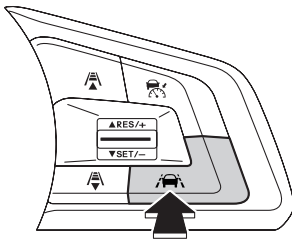

Lane Keep Assist is turned on, and  (white) and lane indicator (gray) are displayed on the EyeSight display area of the combination meter display.

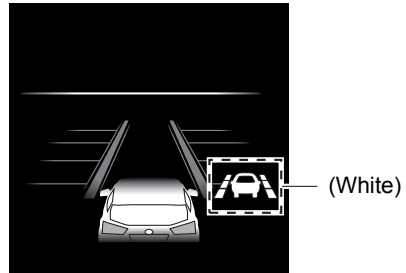

S02658



S02403

Press the  (Lane Keep Assist) switch once again to turn it off, and  is turned off on the EyeSight display area.

The Lane Departure Prevention Function goes into the standby status, and the lane indicator illuminates when all of the following conditions are met.

- The vehicle speed is between approximately 37 MPH (60 km/h) and 90 MPH (145 km/h).
- The system is detecting the lane markings.
- The driver is holding the steering wheel.
- When driving on a road that has a lane width that is between approximately 10 ft (3 m) and 15 ft (4.5 m).
- When driving on a straight road or gentle curve.
- When driving near the center of a lane.

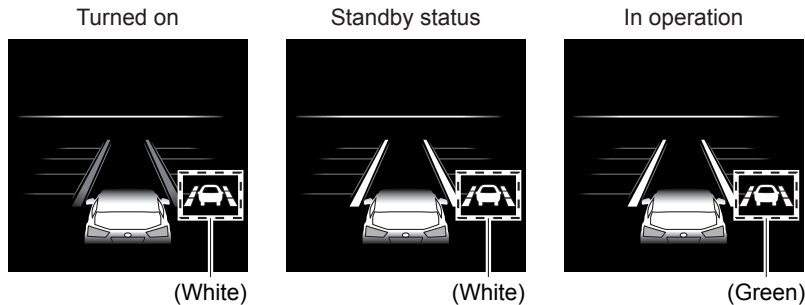

When the vehicle is about to depart from the lane, Lane Departure Prevention Function starts to operate and  illuminates in green while it is operating.



S02404



**NOTE**

- If you just lightly put your hands on the steering wheel for a certain period of time or if you do not operate the steering wheel, the function will automatically be canceled. ( illuminates in white again.) Also, the lane Keep Assist indicator cancellation message is displayed on the screen.
- Lane Departure Prevention Function operates when the system determines that the vehicle will depart from the lane if you continue to drive in the same manner. Therefore, it operates at an earlier timing than Lane Departure Warning (⇒ Refer to page 67) (it may depend on the surrounding environment and road condition).
- The lane indicator in the standby status and in operation may illuminate only on the left side or right side.
-  (Lane Keep Assist indicator) that is illuminating in white keeps doing so when the ignition switch is turned off even though the ignition switch is turned off to stop the engine and then restart it.

## ■ Canceling Lane Departure Prevention Function

### ● Cancellation by the operation of a driver (In case no beep sounds)

The following operation cancels Lane Departure Prevention Function.

If the function is canceled,  and the lane indicator are turned off on the EyeSight display area.

- Press the  (Lane Keep Assist) switch.

Either of the following operations temporarily cancels the Lane Departure Prevention Function.

While temporarily canceling the function,  on the EyeSight display area illuminates in white and the lane indicator is turned off.



- Depressing the brake pedal
- Operating the turn signal lever
- When the system determines that the driver operates the steering wheel to make a lane change.
- Turning on the hazard warning flasher switch

### ● Automatic cancellation by the system (An audible beep will sound.)

Under the following conditions, a beep sounds and the Lane Departure Prevention Function is temporarily canceled.

While the function is temporarily canceled,  on the EyeSight display area illuminates in white and the lane indicator turns to gray.

Also, the Adaptive Cruise Control cancellation message is displayed on the screen.

- When the system cannot detect the lane.
- The windshield wiper operates at a high speed.
- The vehicle speed is less than approximately 34 MPH (55 km/h) or is more than approximately 93 MPH (150 km/h).
- The Vehicle Dynamics Control or the Traction Control Function is activated.
- Either the driver's door, the front passenger's door or the rear door is open.
- The seatbelt of driver's seat is unfastened.
- The select lever is shifted to a position other than  or  position.
- Parking brake is applied.

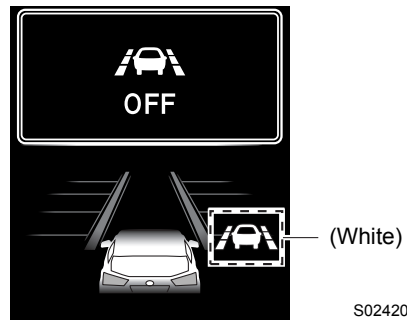

S02420

- The system could not detect the steering operation by the driver for a certain period of time.

- When the system detected no steering operation, the interruption screen appears on the combination meter display. The interruption screen continues to appear until the system detects the steering operation. If the system still cannot detect the steering operation, the Lane Departure Prevention Function is automatically canceled.



S02406

- When entering a sharp curve.
- When driving on a sharp curve.
- When the system determines that the steering assistance is difficult to continue due to the road condition.
- When the system determines that the steering assistance is difficult to operate due to another system.
- When the EyeSight system is temporarily stopped. (“” (EyeSight Temporary Stop indicator: White) is turned on.)

⇒ Refer to page 88.

- When the EyeSight system has a malfunction. (“” (EyeSight Warning indicator: Yellow) is turned on.)

⇒ Refer to page 86.



**NOTE**

If the function is automatically canceled during the standby status ( illuminates in white), no beep sounds.

# Pre-Collision Throttle Management

When an obstacle is detected in front of the vehicle, and the vehicle is stopped or traveling very slowly, if the system determines that the accelerator pedal has been depressed by more than the necessary amount (due to driver error), it greatly restricts engine output and ensures that vehicle forward movement is slower than normal in order to give the driver additional time to brake or react.

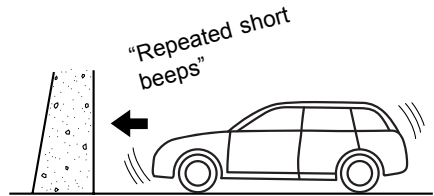

S01125

During system operation, a buzzer will sound several short beeps, and "Obstacle Detected" will be shown on the warning screen area of the combination meter display.

This function only activates when the transmission select lever is in the **D** or **M** position.

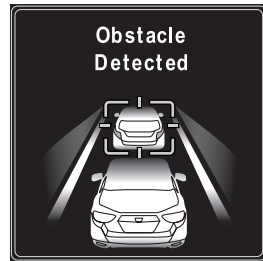

S02401



## WARNING

**Do not rely excessively on Pre-Collision Throttle Management. Pre-Collision Throttle Management is not designed to help you avoid collisions in all situations. Always check the select lever and pedal positions as well as the surrounding environment before starting and operating the vehicle. Relying only on Pre-Collision Throttle Management could result in an accident.**

- Pre-Collision Throttle Management is not designed to maintain the vehicle in a stopped condition.
- Pre-Collision Throttle Management will not reduce acceleration under all conditions. It is also not designed to prevent collisions.
- Pre-Collision Throttle Management will operate when an obstacle is detected in front. However, this function will not reduce acceleration in cases where no obstacle is detected (for example when approaching a cliff, etc.)
- Do not intentionally depress the accelerator pedal excessively when there are obstacles nearby. If the driver relies only on Pre-Collision Throttle Management to control acceleration, collisions may occur.

Continued on next page ⇒

⇒ Continued from previous page

- If your vehicle is trapped on a railroad crossing and you are trying to escape by driving through the crossing gate, the stereo camera may recognize the crossing gate as an obstacle and Pre-Collision Throttle Management system may activate. In this case, remain calm and either continue to depress the accelerator pedal or turn off the Pre-Collision Throttle Management system.

⇒ Refer to page 66.

- Pre-Collision Throttle Management may not activate depending on the following conditions:

- The distance between your vehicle and the obstacle, speed difference, and horizontal offset
- Recognition status of the stereo camera

In particular, the function may not activate in the following cases:

- Bad weather (for example heavy rain, a blizzard or thick fog)
- When visibility is poor due to sand or smoke in the air
- When light is poor in the evening, early morning, or at night
- In a dark area (indoor parking area, etc.)
- When there is an obstacle outside the area illuminated by the headlights
- When affected by strong light from the front (for example sunlight at sunrise or sunset headlight beams, etc.)
- When the windshield has become fogged, scratched, or snow, dirt, dust or frost has adhered to it, or it is otherwise affected.
- When fluid has not been fully wiped off the windshield during or after use of the window washer
- When obstacles cannot be correctly recognized due to water droplets from rain or the washer, or the wiper blades obstructing the stereo camera's field of view
- When the stereo camera's field of view is obstructed (for example by a canoe on the roof of the vehicle)
- With low obstacles (low wall, crash barrier, low vehicle, etc.)
- When the size and height of an obstacle is smaller than the limitations of the stereo camera's recognition capability
  - With small animals or children.
  - With pedestrians who are sitting or lying down
- When the rear portion nearest your vehicle is too small or too close (such as a trailer or oncoming vehicle) the system may not recognize the part of that vehicle which is closest to you.

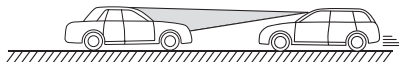
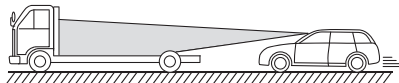

S02134

- When there is a fence or wall, etc., with a uniform pattern (striped pattern, brick, etc.) or with no pattern in front
- When there is a wall or door made of glass or a mirror in front
- When an obstacle (another vehicle, motorcycle, bicycle, pedestrian, animal or child, etc.) cuts in from the side or jumps out suddenly
- When starting, if you change lanes and your vehicle is immediately behind the obstacle
  - On sharp curves, steep uphill grades or steep downhill grades
- When the system determines that steering operation by the driver is intended as evasive action
- For your safety, do not test Pre-Collision Throttle Management on its own. It may operate improperly and cause an accident.

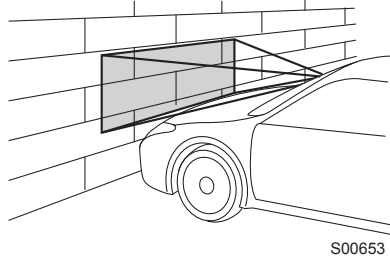



 **CAUTION**

- In the following situations, turn off Pre-Collision Throttle Management. Otherwise Pre-Collision Throttle Management may activate unexpectedly.
  - When the vehicle is being towed
  - When loading the vehicle onto a carrier
  - When a chassis dynamometer, free-rollers or similar equipment is used
  - When a mechanic lifts up the vehicle, starts the engine and allows the wheels to spin freely
  - When passing hanging banners, flags or branches, or when thick/tall vegetation is contacting the vehicle
- The Pre-Collision Throttle Management may activate in the following situations. Therefore concentrate on safe driving.
  - When your vehicle is close to the vehicle in front
  - When passing through an automatic gate
  - When your vehicle is in a location where the grade of the road changes rapidly

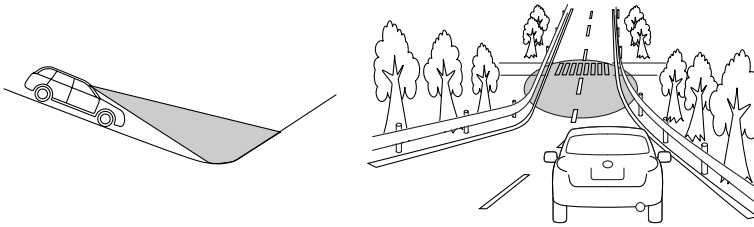

S01264

- When passing through clouds of steam or smoke

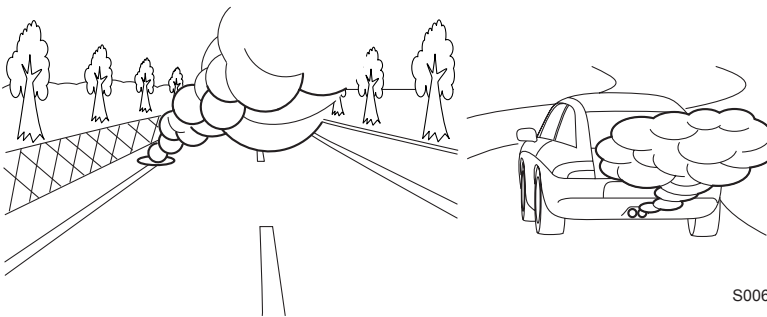

S00652

- When there is an obstacle on a curve or intersection
- When narrowly passing a vehicle or object
- When stopping very close to a wall or a vehicle in front

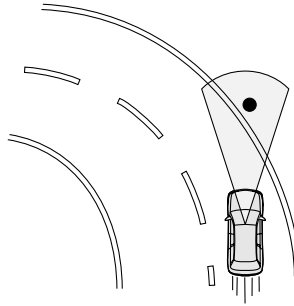

S02669

**NOTE**

- When the accelerator pedal is depressed for approximately three seconds, Pre-Collision Throttle Management will be released gradually.
- When the Pre-Collision Braking System is turned off, Pre-Collision Throttle Management is also turned off.

⇒ Refer to page 31.

## Turning off Pre-Collision Throttle Management

Press and hold the Pre-Collision Braking System OFF switch for approximately 2 seconds or longer to turn off the Pre-Collision Throttle Management System. When 1 short beep sound emits, this function is turned off and the Pre-Collision Braking System OFF indicator light on the instrument panel illuminates.

To turn the system back on, press and hold the Pre-Collision Braking System OFF switch again for approximately 2 seconds or longer. When this function is turned on, the Pre-Collision Braking System OFF indicator light turns off.

⇒ Refer to page 32.

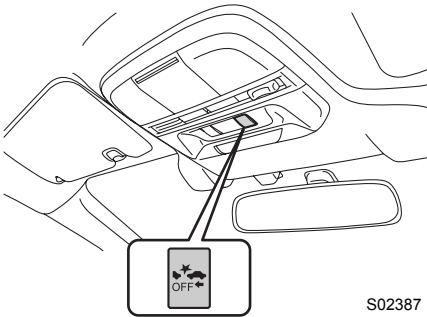

S02387

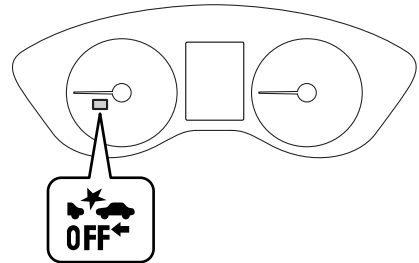

S02407



### NOTE

- When Pre-Collision Throttle Management is turned off, the Pre-Collision Braking System also turns off.
- Even when Pre-Collision Throttle Management is turned off, if the ignition switch is turned off and the engine is restarted, Pre-Collision Throttle Management will be turned on. The default setting for Pre-Collision Throttle Management when the vehicle is restarted is "ON".

# Lane Departure Warning

When vehicle speed is approximately 30 MPH (50 km/h) or more, this function warns the driver if the system detects that the vehicle is likely to depart the traffic lane.

When the Lane Departure Warning activates, a buzzer sounds 3 short beeps, and interruption screens are displayed.

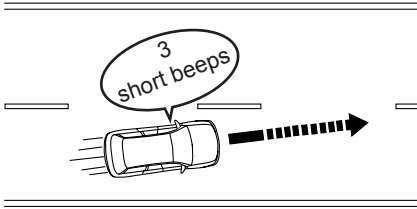

S02416



S02408

\* The illustration depicts a vehicle departing the left lane.



**WARNING**

Lane Departure Warning will not operate in all conditions. It also will not automatically return the vehicle to the original lane. If the driver relies only on the Lane Departure Warning to keep the vehicle in the lane, lane departure may occur, resulting in an accident.

The Lane Departure Warning activates when it detects lane markings. However, it is not a function which can detect the edge of a road (shoulders or side ditches, etc.) and warn the driver.



**CAUTION**

In the following situations, the Lane Departure Warning may not activate:

- Vehicle speed is approximately 30 MPH (50 km/h) or less.
- When the steering wheel is turned significantly to either side
- When the vehicle is driving around a curve whose radius is 0.18 miles (300 m) or smaller.
- When the brake pedal is depressed or immediately after it is depressed
- When the following distance behind a vehicle in front is short
- While the turn signal is operating and for approximately 4 seconds after the turn signal lever has returned to its original position
- When the vehicle has not returned to the inside of the lane after the Lane Departure Warning has activated
- The lane is narrow.
- When it is difficult for the camera to detect lane markings
  - There are no lane markings or they are very worn.
  - The lane markings are yellow.
  - It is difficult to detect lane markings as they are similar in color to the road surface.
  - The lane markings are narrow.



**NOTE**

- The following situations may cause incorrect lane detection and a faulty Lane Departure Warning to occur.
    - When there are tire tracks on a wet road or snow-covered road
    - When there are boundaries between snow and asphalt, or marks from road repair, etc.
    - When there are the shadows of guardrails
    - When lane markings are drawn in double
    - When there are some lane markings left from roadwork or markings from the previous road.
  - When the Lane Departure Warning OFF indicator light is illuminated, the Lane Departure Warning is inactive.
- ⇒ Refer to page 69.

## Turning off Lane Departure Warning

Press and hold the Lane Departure Warning OFF switch for approximately 2 seconds or longer to turn off the Lane Departure Warning. When 1 short beep sound emits, this function is turned off and the Lane Departure Warning OFF indicator light on the instrument panel will illuminate.

To turn the function back on, press and hold the Lane Departure Warning OFF switch again for approximately 2 seconds or longer. When the function is turned on, the Lane Departure Warning OFF indicator light turns off.

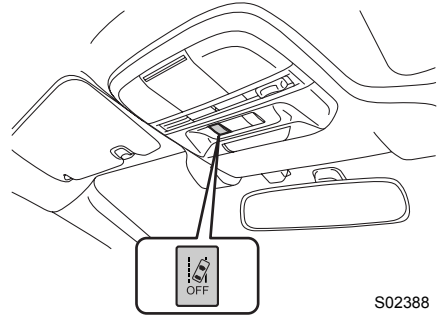

S02388



### NOTE

- When the Lane Departure Warning is turned off, the Lane Sway Warning is also turned off.
- The ON/OFF status of the Lane Departure Warning is restored when you restart the engine.

## ■ Lane Departure Warning OFF indicator light

This indicator illuminates when the ignition switch is turned to the ON position, and then approximately 7 seconds after the engine starts, it turns off or remains illuminated depending on the current status (ON or OFF). It turns on when the Lane Departure Warning is turned off.

It also illuminates under the following conditions.

- When the EyeSight system has a malfunction  
⇒ Refer to page 86.
- When the EyeSight system has stopped temporarily  
⇒ Refer to page 88.

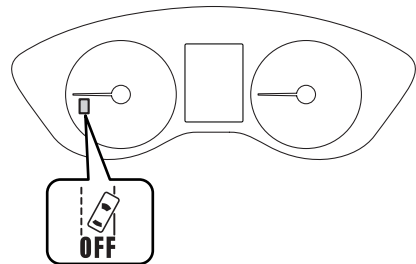

S02409

# Lane Sway Warning

This function detects swaying or drifting within a lane, and warns the driver. Sway Warning activates, a buzzer sounds 3 short beeps, and interruption screens are displayed.

This function activates when the vehicle speed exceeds approximately 37 MPH (60 km/h) and deactivates when the vehicle speed falls below approximately 25 MPH (40 km/h). The function will reactivate when the vehicle speed is increased to exceed approximately 37 MPH (60 km/h).

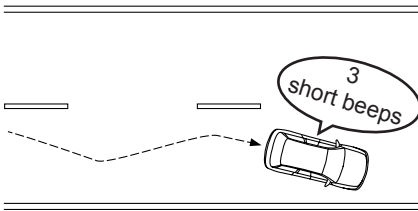

S02417



S02410



## WARNING

Lane Sway Warning will not operate in all conditions. It also will not automatically correct swaying. If the driver relies only on the Lane Sway Warning to prevent the vehicle from swaying, an accident may occur.



## CAUTION

Under the following conditions, the Lane Sway Warning may not operate.

- When driving on a winding road
- When vehicle speed changes greatly
- Immediately after a lane change
- When it is difficult for the EyeSight stereo camera to detect lane markings
  - There are no lane markings or they are the very worn.
  - It is difficult to detect lane markings as they are similar in color to the road surface.
  - The lane markings are narrow.

**NOTE**

- Swaying detection is based on several minutes of prior driving data. Swaying will not be detected immediately after the vehicle starts to sway. In addition, the warning may continue for some time even after swaying stops.
  - The Lane Sway Warning System is just a function that warns the driver. When the driver is tired, not concentrating on the road or not paying adequate attention to driving, be sure to take rest breaks as often as needed.
  - When the Lane Departure Warning OFF indicator light is illuminated, the Lane Sway Warning will not operate.
- ⇒ Refer to page 69.



## Turning off Lane Sway Warning

Press and hold the Lane Departure Warning OFF switch for approximately 2 seconds or longer to turn off the Lane Sway Warning. When 1 short beep sound emits, this function is turned off and the Lane Departure Warning OFF indicator light on the instrument panel illuminates.

To turn the function back on, press and hold the Lane Departure Warning OFF switch again for approximately 2 seconds or longer. When the function is turned on, the Lane Departure Warning OFF indicator light turns off.

⇒ Refer to page 69.

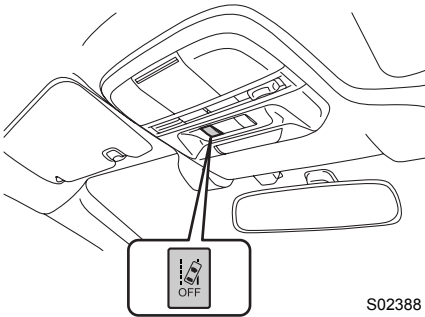

S02388

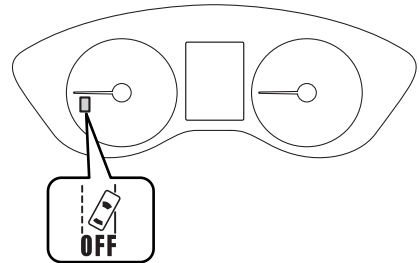

S02409



### NOTE

- When the Lane Sway Warning is turned off, the Lane Departure Warning is also turned off.
- The ON/OFF status of the Lane Sway Warning is restored when you restart the engine.

# Lead Vehicle Start Alert

When the vehicle stopped in front starts to move, the Lead Vehicle Start Alert notifies the driver by indicator on the combination meter display and buzzer. When the vehicle in front remains stopped continuously (within a following distance of approximately 32 ft (10 m) and the driver's vehicle remains stopped for several seconds or longer), the system continues to detect the vehicle in front and this alarm activates if the vehicle in front advances approximately 10 ft (3 m) or more while the driver's vehicle remains stationary.

This function only activates when the select lever is in the **D**, **M** or **N** position.

When the Lead Vehicle Start Alert activates, a buzzer sounds a two-tone beep, and interruption screens are displayed.

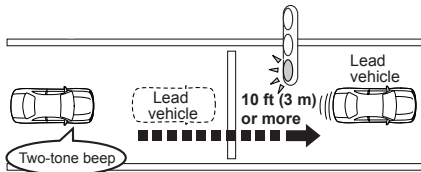

S01266



S02411

## WARNING

Even after alerts are given audibly and through the display of an indicator, be sure to carefully check the area surrounding the vehicle before pulling away. Relying solely on the Lead Vehicle Start Alert may result in an accident.

## NOTE

- The Lead Vehicle Start Alert setting can be turned on or off.  
⇒ Refer to page 90.
- Under the following conditions, the Lead Vehicle Start Alert may activate even when the vehicle in front has not started to move, or may not activate even after the vehicle in front has started to move:
  - A motorcycle or similar object cuts in between your vehicle and the stopped vehicle in front.
  - Weather or road conditions may interfere with the detection of the vehicle in front.
  - When the EyeSight stereo camera loses detection of the vehicle in front.

# Conventional Cruise Control

## About Conventional Cruise Control

Conventional Cruise Control is a driving support system intended to allow more comfortable driving on expressways, freeways and interstate highways. It can be used to travel at a constant speed by maintaining the vehicle speed set by the driver. Please remember that you should not exceed posted speed limits.





### WARNING

- When Conventional Cruise Control is functioning, the system does not perform the following control to maintain a following distance, as when using Adaptive Cruise Control.  
Strive for safe driving and depress the brake pedal to decelerate the vehicle as necessary in order to ensure a safe following distance from the vehicle in front.
- Under the following conditions, do not use the Conventional Cruise Control. Doing so may result in an accident.
  - Roads with heavy traffic or roads with sharp curves  
Maintaining an appropriate speed for such road conditions may be difficult.
  - Frozen roads, snow-covered roads or slippery road surfaces  
The tires may spin, causing your vehicle to lose control.
  - Steep downhill grades  
The set vehicle speed may be exceeded.
  - On a steep continuous downhill grade  
The brakes may overheat.





### CAUTION

When using Cruise Control, be sure to check the EyeSight display area to confirm which Cruise Control mode is selected: Adaptive Cruise Control or Conventional Cruise Control.

- If Adaptive Cruise Control is selected, “” (Adaptive Cruise Control indicator) illuminates.
- If Conventional Cruise Control is selected, “” (Conventional Cruise Control indicator) illuminates.



### NOTE

- When the  (CRUISE) switch is first turned on, the Adaptive Cruise Control is set.
- To change the Cruise Control mode, press and hold the  /  (following distance setting) switch for approximately 2 seconds or longer. (This is effective only when the main Cruise Control is on and neither Adaptive Cruise Control nor Conventional Cruise Control are set.)
- Conventional Cruise Control can be used even when EyeSight is temporarily turned off.



## How to use the Conventional Cruise Control

Conventional Cruise Control can be set when the following conditions are met.

- The select lever is in the **D** or **M** position.
- The brake pedal is released.
- The vehicle speed is between approximately 20 MPH (30 km/h) and 90 MPH (145 km/h).
- Parking brake is released.

### ■ Setting Conventional Cruise Control

(1) Setting the Conventional Cruise Control to standby status.

Press the  (CRUISE) switch. At this time,  (Adaptive Cruise Control) and the following distance setting indicator are displayed on the EyeSight display area of the combination meter display. The set vehicle speed display will read “- - MPH”.

When the  (CRUISE) switch is pressed, the initial cruise control mode is always Adaptive Cruise Control.

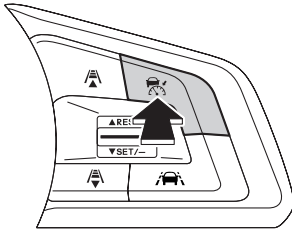

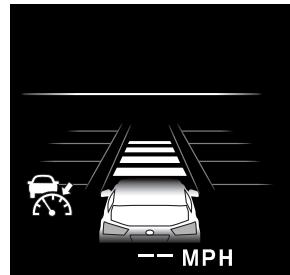

S02390



S02391

If the  (CRUISE) switch is pressed once more, the EyeSight display will turn off. It will also automatically turn off when the engine is stopped.

(2) Switch to Conventional Cruise Control.

Press and hold the  /  (following distance setting) switch for approximately 2 seconds or longer to switch from Adaptive Cruise Control to Conventional Cruise Control. A buzzer sounds 1 short beep.

At this time, the following distance setting indicator on the EyeSight display area of the combination meter display turns off and  is displayed.

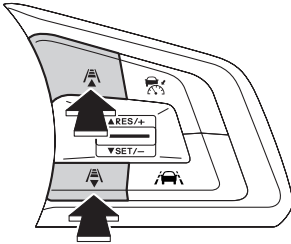

S02657

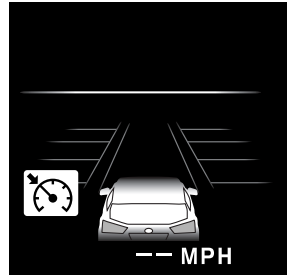

S02413

To set the ready status:

Conventional Cruise Control can be set when all of the following conditions are met and **READY** is displayed on the EyeSight display area.

- All doors (except the rear gate/trunk) are closed.
- The driver's seatbelt is fastened.
- The select lever is in the **D** or **M** position.
- The brake pedal is not depressed.
- The road is not on a steep slope.
- The steering wheel has not been turned significantly in either direction.
- The vehicle speed is between approximately 20 MPH (30 km/h) and 90 MPH (145 km/h).
- Parking brake is released.

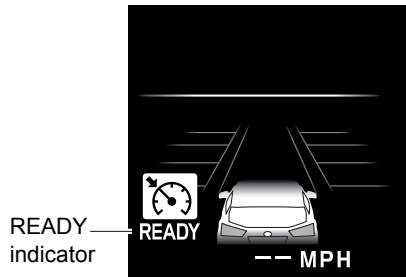

S02711

(3) Control the accelerator pedal to reach the desired speed.

- (4) When the vehicle speed is between approximately 20 MPH (30 km/h) and 90 MPH (145 km/h), press the RES/SET switch to the “SET/-” or “RES/+”.

The vehicle speed at the time when the switch is pressed will become the set vehicle speed, and constant speed driving will initiate.

 changes from white to green.

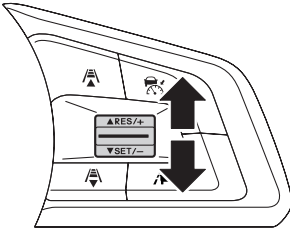

S02654

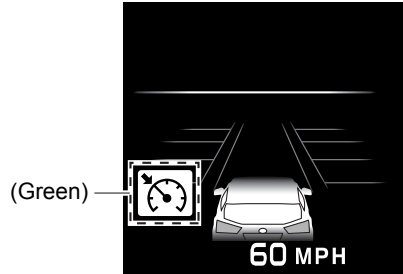

S02414



### WARNING

The “Obstacle Detected” warning will not activate while Conventional Cruise Control is functioning.

### CAUTION

During Conventional Cruise Control use, accelerator and brake control to follow the vehicle in front is not performed. Operate the accelerator and brake pedals as necessary.

### NOTE

- On a downhill grade, automatic braking may operate in order to maintain the set vehicle speed.
- When driving on a curve, the vehicle may not accelerate, or may decelerate, even if the set speed is higher than the current vehicle speed.
- To return to Adaptive Cruise Control use, cancel the Conventional Cruise Control then briefly press the  /  (following distance setting) switch. A buzzer will sound (one short beep) when switching to Adaptive Cruise Control.

## ■ Increasing the set vehicle speed

The following two methods can be used to increase the set vehicle speed.

### ● Using the RES/SET switch

- Pressing to the “RES/+” side briefly  
Every time you press the “RES/+” side, the set vehicle speed will increase to the next 5 MPH (5 km/h) increment.
- Pressing the “RES/+” side continuously  
While pressing the “RES/+” side, the set vehicle speed will increase by 1 MPH (1 km/h).

When the switch is operated, the set vehicle speed on the combination meter display will change.

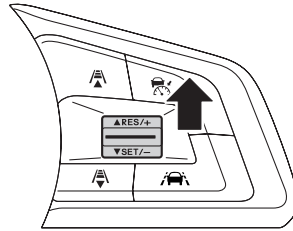

S02655

### ● Using the accelerator pedal

Operate the accelerator pedal to increase the vehicle speed.

When the desired speed is reached, press the RES/SET switch to the “SET/-”. When the switch is released, the new vehicle speed is set.

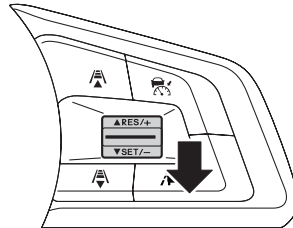

S02656

## ■ Decreasing the set vehicle speed

### ● Using the RES/SET switch

- Pressing to the “SET/-” side briefly  
Every time you press the “SET/-” side, the set vehicle speed decreases to the next 5 MPH (5 km/h) decrement.
- Pressing to the “SET/-” side continuously  
While pressing the “SET/-” side, the set vehicle speed decreases by 1 MPH (1 km/h).

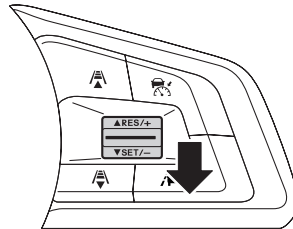

When the switch is operated, the set vehicle speed on the combination meter display will change.

S02656

### ● Using the brake pedal

- (1) Depress the brake pedal to decrease the vehicle speed. (Conventional Cruise Control will be canceled and  changes from green to white.)
- (2) When the desired speed is reached, press the RES/SET switch to the “SET/-”. The speed at the time of pressing the switch will be set as the new vehicle speed, and it appears in the EyeSight display area.

## ■ Accelerating temporarily

Depress the accelerator pedal to accelerate temporarily.

When the accelerator pedal is released, the vehicle returns to the set vehicle speed.



## ■ Decelerating temporarily

Depress the brake pedal to decelerate temporarily. When the brake pedal is depressed, Conventional Cruise Control will be canceled. While the set vehicle target speed remains displayed on the EyeSight display area,  changes from green to white. Release the brake pedal and press the RES/SET switch for "RES/+" to reset the set vehicle target speed.

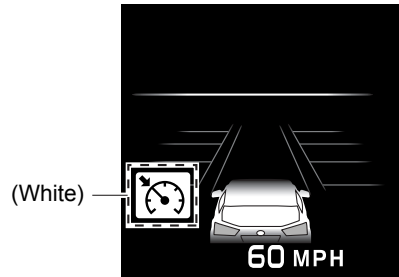

S02415

## ■ Canceling Conventional Cruise Control

### ● Manual Cancellation by the driver



Any of the following operations will cancel Conventional Cruise Control.

- Depress the brake pedal.

 changes from green to white while the set vehicle target speed remains displayed on the EyeSight display area.

- Press the  (CRUISE) switch.

 changes from green to white while the set vehicle target speed remains displayed on the EyeSight display area.

When the  (CRUISE) switch is pressed again, the  will be turned off and Conventional Cruise Control will be turned off.

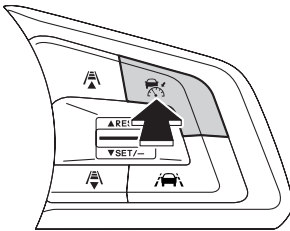

S02390

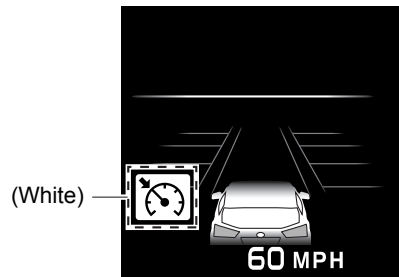



S02415

## ● Automatic cancellation by the system

In the following cases, a buzzer sounds 1 short beep and 1 long beep and the Cruise control function is automatically canceled. (  changes from green to white.) Also, the Conventional Cruise Control cancellation message is displayed on the screen.

After the conditions listed below have been resolved, perform the cruise control set operation again to reactivate cruise control.

- The select lever was moved to a position other than  or .

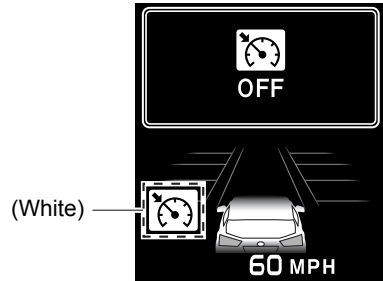

S02498

- Vehicle speed drops to approximately 16 MPH (25 km/h) or less (due to a steep uphill grade or some other reason).
- Vehicle speed increases to approximately 100 MPH (160 km/h) or more.
- The Vehicle Dynamics Control or the Traction Control Function is activated.
- Any door (except the rear gate/trunk) was opened.
- The driver's seatbelt is unfastened.
- EyeSight is malfunctioning. (⇒ Refer to page 86, "EyeSight malfunction and temporary stop".)
- The steering wheel is turned significantly in either direction.
- The grade of the road is steep.
- The Pre-Collision secondary braking has activated.
- Parking brake is applied.



### WARNING

Do not use Conventional Cruise Control on slippery roads. Doing so may result in an accident.

 **CAUTION**

When shifting the select lever to the **[N]** position, Conventional Cruise Control will be automatically canceled. Do not shift the lever to the **[N]** position unless it is an emergency. Otherwise the engine brake may not operate, which could cause an accident.

 **NOTE**

- If EyeSight is malfunctioning, the EyeSight warning indicator is displayed on the combination meter display and the Pre-Collision Braking System OFF indicator light and Lane Departure Warning OFF indicator light illuminate. If this occurs, stop the vehicle in a safe location and then stop the engine and restart it. If the indicators remain illuminated after restarting the engine, Conventional Cruise Control cannot be used. This will not interfere with ordinary driving; however the system should be inspected by a SUBARU dealer as soon as possible.

⇒ Refer to page 86.

- When operation of Conventional Cruise Control has been automatically canceled, perform the set operation again after the condition that caused the cancellation has been resolved. If cruise control cannot be set even after the condition has been corrected, EyeSight may be malfunctioning. This will not interfere with ordinary driving; however the system should be inspected by a SUBARU dealer as soon as possible.

## ■ Resuming a vehicle speed that was previously stored

A vehicle speed that has been previously set is stored in memory\*. To recall and set that vehicle speed, press the RES/SET switch to the "RES/+". (The EyeSight display area shows the set condition again.)

Resume is possible when a vehicle speed was previously set, and the current vehicle speed is approximately 20 MPH (30 km/h) or more.

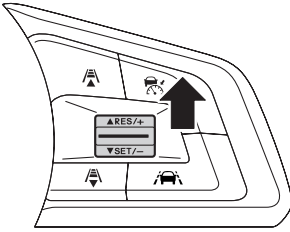

S02655

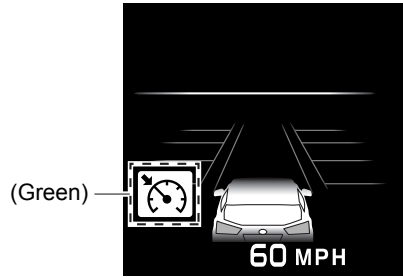

S02414



### NOTE

- The vehicle speed stored in memory is erased in the following circumstances:
  - The cruise control is turned off by pressing the  (CRUISE) switch.
  - Either vehicle Dynamics Control or Traction Control Function has been activated.
  - The cruise control mode was switched from Conventional Cruise Control to Adaptive Cruise Control.
- The vehicle drives constantly and correspondingly to the set vehicle speed between 20 MPH (30 km/h) and 90 MPH (145 km/h).
- If there is no vehicle speed in the memory (a previously set vehicle speed), press the RES/+ switch to set the vehicle speed (20 MPH (30 km/h) to 90 MPH (145 km/h)).

# List of buzzer sounds

Buzzer sound	Status	Reference page
Single continuous beep	Pre-Collision Braking System: Secondary Braking is active.	⇒ Refer to page 28.
1 short beep and 1 long beep	Adaptive Cruise Control or Conventional Cruise Control is canceled automatically.	⇒ Refer to pages 48 and 81.
	Lane Keep Assist is canceled automatically.	⇒ Refer to page 59.
Repeated short beeps	Pre-Collision Braking System: First Braking is active.	⇒ Refer to page 28.
	Pre-Collision Braking System: The following distance warning is active.	
	The "Obstacle Detected" warning from Adaptive Cruise Control is active.	⇒ Refer to page 51.
	Pre-Collision Throttle Management is active.	⇒ Refer to page 61.
3 short beeps	The Lane Departure Warning is active.	⇒ Refer to page 67.
	The Lane Sway Warning is active.	⇒ Refer to page 70.
3 short beeps and 1 long beep	Pre-Collision Braking System: Just before the automatic brake is slowly released by the system after the vehicle is stopped by the pre-collision braking.	⇒ Refer to page 21.
	Adaptive Cruise Control System: Just before the automatic brake is released by the system after the vehicle is stopped by the Adaptive Cruise Control System. Adaptive Cruise Control System will stop the vehicle according to the lead vehicle stops.	⇒ Refer to page 33.
1 short beep	Either of the following occurred while Adaptive Cruise Control was set. - A vehicle in front is detected*. - A vehicle in front is no longer detected*.	⇒ Refer to page 41.
	The cruise control mode (Adaptive Cruise Control ↔ Conventional Cruise Control) is changed.	⇒ Refer to pages 76 and 77.
	EyeSight is malfunctioning.	⇒ Refer to pages 86 and 88.
	EyeSight operation is temporarily stopped.	
	Pre-Collision Braking System and Pre-Collision Throttle Management are turned on/off.	⇒ Refer to pages 31 and 66.
The Lane Departure Warning and the Lane Sway Warning are turned on/off.	⇒ Refer to pages 69 and 72.	

Buzzer sound	Status	Reference page
Two-tone beep	Lead Vehicle Start Alert is active*.	⇒ Refer to page 73.

\*The buzzer that indicates when a lead vehicle is detected or when it is no longer detected (Lead Vehicle Acquisition Sound), as well as the Lead Vehicle Start Alert can be turned on or off.

⇒ Refer to page 90.

# EyeSight malfunction and temporary stop

If a malfunction is detected in the EyeSight system, the indicators in the instrument panel and the combination meter display inform the driver of the malfunction. Check the displayed contents and take the appropriate action.

## ■ Malfunction (including position/angle misalignment of stereo camera)

The buzzer sounds 1 short beep and the EyeSight warning indicator  (yellow) flashes or illuminates. At the same time, the Pre-Collision Braking System OFF indicator light and the Lane Departure Warning OFF indicator light will illuminate. A message will also be displayed on the combination meter display.

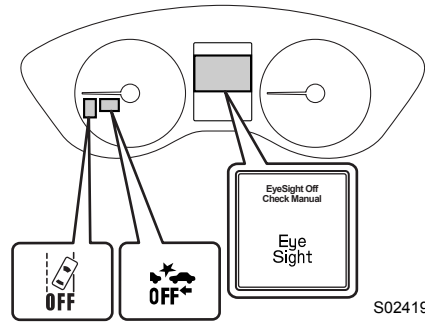

Displayed screen	Cause	Action
 S00699	An EyeSight malfunction or position/angle misalignment of stereo camera has occurred.	Inspection and adjustment is necessary. Contact your SUBARU dealer.

### CAUTION

If both the EyeSight warning indicator and the CHECK ENGINE warning light/malfunction indicator light illuminate at the same time while driving, have your vehicle checked/repared by a SUBARU dealer as soon as possible. EyeSight cannot be used if there is an abnormality with the engine, etc.



**NOTE**

- If the EyeSight warning indicator illuminates or flashes, stop the vehicle in a safe location, turn off the engine, and then restart it.
- If the EyeSight warning indicator illuminates or flashes, the RAB system may not operate (models equipped with RAB).
- If the indicator continues illuminating or flashing even after the engine has been restarted, the EyeSight system has a malfunction. In this case, all EyeSight functions will be stopped. Normal driving will still be possible. However, contact a SUBARU dealer for an inspection.



## Temporary stop

The buzzer will sound one short beep, and the EyeSight temporary stop indicator (white), Pre-Collision Braking System OFF indicator light and Lane Departure Warning OFF indicator light will illuminate at the same time.

A message will also be displayed on the combination meter display.

When the cause has been resolved, temporary stop will be canceled and the EyeSight system will automatically restart.

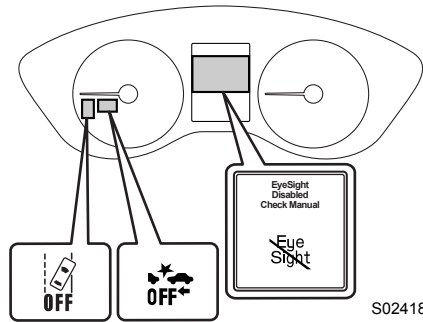

S02418

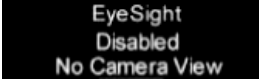
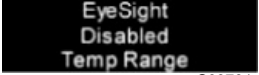
Displayed screen	Cause	Action
 <p>S00700</p>	<p>It is difficult for the stereo camera to detect objects in front</p> <ul style="list-style-type: none"> <li>• The windshield is dirty or fogged up</li> <li>• Poor weather conditions</li> <li>• Strong light from the front</li> </ul>	<ul style="list-style-type: none"> <li>• Clean the windshield.</li> <li>• In poor weather conditions or if there is strong light from the front, the EyeSight system will restart once you have driven your vehicle for a period of time and the conditions affecting the system have improved. If the system does not restart, even after the conditions have improved and a period of time has elapsed, contact your SUBARU dealer for an inspection.</li> </ul>
 <p>S00701</p>	<p>In low or high temperatures</p>	<p>The system will restart once the temperature is within the operational range of the EyeSight system. If the system does not restart, even when the temperature inside the vehicle is within the operational range, contact your SUBARU dealer for an inspection.</p>

Displayed screen	Cause	Action
 <p data-bbox="336 357 391 371">S00694</p>	<ul style="list-style-type: none"> <li>• The EyeSight system is starting up.</li> <li>• The system has determined that the vehicle is extremely inclined.</li> <li>• The pre-collision secondary braking has operated 3 times after the engine was started.</li> <li>• The engine has stopped.</li> <li>• The electronic power steering system is in the overheating prevention status because the steering wheel has been operated while the vehicle is at a standstill or driving at an extremely slow speed.</li> <li>• The EyeSight system judged a different value due to the removal or installation of the steering wheel.</li> <li>• The wheels are out of balance.</li> <li>• The wheels are out of alignment.</li> </ul>	<p>The system will restart once the cause has been eliminated. At this time, it may take some time for the system to restart. If the system does not restart, even after the conditions have improved and a period of time has elapsed, contact your SUBARU dealer for an inspection.</p>



### NOTE

- When the EyeSight temporary stop indicator is illuminated, no EyeSight functions can be used except for Conventional Cruise Control.
- When the EyeSight temporary stop indicator is illuminated, the RAB system may not operate (models equipped with RAB).

# Customizing functions

The following settings can be changed on the combination meter display.

Item		Setting	Default setting
Warning Volume	Warning Volume	Max/Mid/Min	Mid
EyeSight	Lead Vehicle Acquisition Sound	ON/OFF	ON
	Lead Vehicle Moving Monitor Function	ON/OFF	ON
	Cruise Control Acceleration Characteristics	Lv. 1 (Eco)/ Lv. 2 (Comfort)/ Lv. 3 (Standard)/ Lv. 4 (Dynamic)	Lv. 3 (Standard)



## NOTE

The following settings can be restored to the factory (default) settings.  
 ⇒ Refer to the Owner's Manual for your vehicle.

## ■ How to customize

Operations can be performed when the select lever is in the **P** position and the ignition switch is in the ON position while the vehicle is parked. However, the Cruise Control Acceleration Characteristics and warning volume can be changed, even while you are driving.

(1) Pull the ▲ / ▼ switch toward you to display the “Change settings” screen.

Pull and hold the **i** (Info)/SET switch to change to the settings screen.

(2) Pull the ▲ / ▼ switch toward you, select “EyeSight”, and pull the **i** (Info)/SET switch to confirm.

The system will then switch to the EyeSight settings screen.

Operate the following switches according to the display on the screen.

- Select: ▲ (Return) switch/  
▼ (Send) switch
- Confirm: **i** (Info)/SET switch

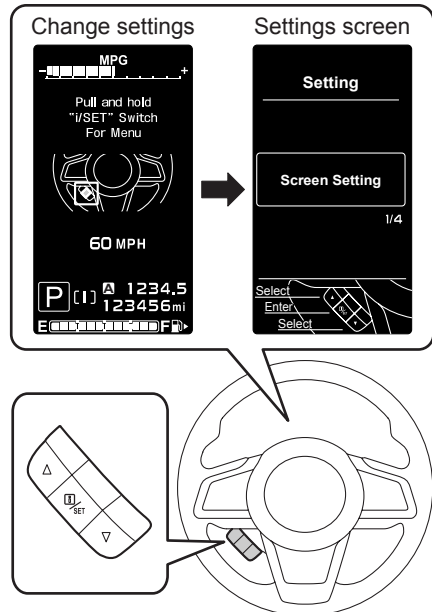

S02421

### ● Warning Volume setting

The volume can be set to Max/Mid/Min.

When on the Warning Volume settings screen, if the volume is selected with the ▲ / ▼ switch, 3 short beeps will sound.

### ● Lead Vehicle Acquisition Sound setting

The Lead Vehicle Acquisition Sound setting can be activated (ON) or deactivated (OFF).

### ● Lead Vehicle Moving Monitor Function

The Lead Vehicle Start Alert function setting can be activated (ON) or deactivated (OFF).

### ● The Cruise Control Acceleration Characteristics of the Adaptive Cruise Control system can be set to one of four levels.

Lv. 4 (Dynamic): Mode used when powerful acceleration is required.

Lv. 3 (Standard): Mode used when performing frequent following, with a following function that focuses on the speed of the vehicle ahead.

Lv. 2 (Comfort): Mode used when performing following with smooth movement.

Lv. 1 (Eco): Mode that focuses on fuel economy over following the vehicle ahead, it is used when performing following with smooth movement.



#### NOTE

When "Return" is selected, the system will return to the screen 1 level above the current one.

### ● Canceling the custom functions

In the following cases, the custom functions will be canceled and the "Change settings" screen will be displayed.

- When you pull and hold the **i** (Info)/SET switch toward you
- When the engine is turned off
- When the switch is not operated for approximately 30 seconds

# Message screen list



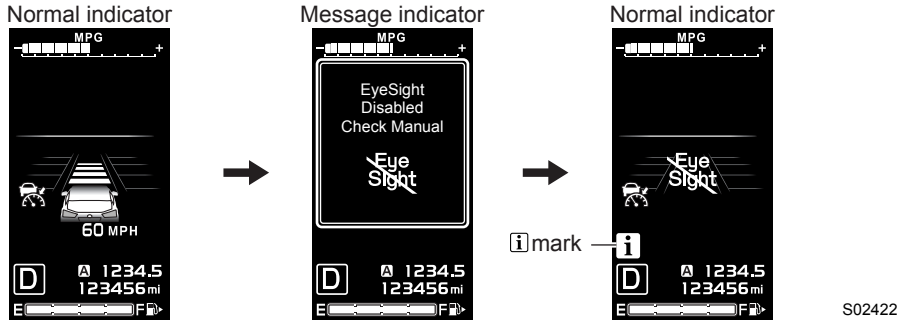

If an EyeSight warning or malfunction is detected, a message will be displayed on the combination meter display. Depending on the message, a buzzer will sound at the same time.

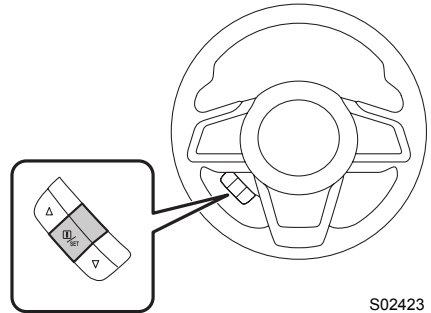

If a message is displayed, refer to the message list and take the appropriate action. While the **i** mark is illuminated, you can pull the **i** (Info)/SET switch to display the message again.

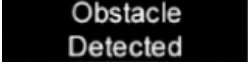

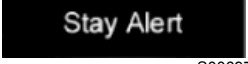
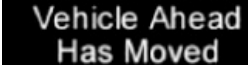
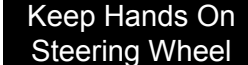





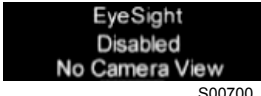
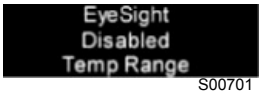
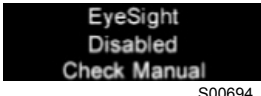

## ■ Message screen list (precautions and notices)



Item	Displayed screen	<b>i</b> mark	Action
Pre-Collision Braking System		None	⇒ Refer to page 28.
The “Obstacle Detected” warning	 S00695	None	⇒ Refer to page 51.
Pre-Collision Throttle Management		None	⇒ Refer to page 61.
Lane Departure Warning	 S00696	None	⇒ Refer to page 67.
Lane Sway Warning	 S00697	None	⇒ Refer to page 70.
Lead vehicle Start alert	 S00698	None	⇒ Refer to page 73.
Steering operation not detected by Lane Keep Assist	 S01997	None	⇒ Refer to page 60.
Adaptive Cruise Control/Conventional Cruise Control automatic cancellation (when the grade of the road is very steep)	 S02425	None	⇒ Refer to pages 48 and 81.

## ■ Message screen list (malfunction, temporary stop)









Item	Displayed screen	i mark	Action
EyeSight System Malfunction	 <p>EyeSight Off Check Manual S00699</p>	Yes (yellow)	⇒ Refer to page 86.
EyeSight system temporary stop	 <p>EyeSight Disabled No Camera View S00700</p>	Yes (white)	⇒ Refer to page 88.
	 <p>EyeSight Disabled Temp Range S00701</p>	Yes (white)	⇒ Refer to page 88.
	 <p>EyeSight Disabled Check Manual S00694</p>	Yes (white)	⇒ Refer to page 89.



# Troubleshooting



	<p>Adaptive Cruise Control cannot be set.</p>
	<p>Did you remember to press the  (CRUISE) switch? If you have not pressed the  (CRUISE) switch,  (Adaptive Cruise Control) will not be shown.</p>
	<p>Is EyeSight operation temporarily stopped? When EyeSight is temporarily stopped,  is displayed on the combination meter display. Set Adaptive Cruise Control again after the cause for the temporary stop has been corrected.</p>
	<p>Is <b>READY</b> displayed? Adaptive Cruise Control cannot be set when <b>READY</b> is not displayed. Set Adaptive Cruise Control when <b>READY</b> is displayed.</p>









	<p><b>READY</b> is not displayed.</p>
	<p>Are the requirements for setting cruise control met? In any of the following cases, <b>READY</b> will not be displayed.</p> <ul style="list-style-type: none"> <li>• The brake pedal is depressed.</li> <li>• The vehicle speed is not between approximately 0 MPH (0 km/h) and 90 MPH (145 km/h) (when Adaptive Cruise Control is operating).</li> <li>• The vehicle speed is not between approximately 20 MPH (30 km/h) and 90 MPH (145 km/h) (when Conventional Cruise Control is operating).</li> <li>• The combination meter indicates a position other than <b>D</b> or <b>M</b>.</li> <li>• The driver's seatbelt is unfastened.</li> <li>• Any door is open (except the rear gate/trunk).</li> <li>• The vehicle is on a steep grade.</li> <li>• The steering wheel is turned significantly in either direction.</li> <li>• Parking brake is applied.</li> <li>• The EyeSight system is stopped temporarily (Adaptive Cruise Control).</li> </ul>

















	<p>A vehicle (in front of your vehicle) is not detected, detection is delayed or detection is lost quickly.</p>
	<p>Is the vehicle in front stopped, moving slowly relative to your vehicle or moving extremely slowly? Detection of stopped vehicles, vehicle moving slowly relative to your vehicle, and vehicles moving extremely slowly may be difficult.</p>
	<p>Is the windshield dirty or fogged? If the windshield is dirty or fogged, it may not be possible to detect object or vehicles. Clean off the dirt or fog from the windshield, and then try using the system again.</p>
	<p>Is the vehicle in front far away? The maximum detection distance of EyeSight's stereo camera is approximately 360 ft (110 m). Detection is not possible if the vehicle is farther away.</p>
	<p>Is the vehicle on a curve? The detection range is limited in the horizontal directions when the camera is properly aimed.</p>
	<p>Is the vehicle on a road with repeated uphill and downhill grades (such as an overpass), or on a banked road? The detection range is limited in the vertical directions.</p>
	<p>Did the vehicle detected in front change? Detection may be delayed after the vehicle in front has changed.</p>
	<p>Have water, snow or other substances been kicked up by the vehicle in front as it drives? When water or snow have been kicked up, it may not be possible to detect the vehicle in front.</p>

	<p>Control is activated even though there is no vehicle in front detected.</p>
	<p>Is there a vehicle in the neighboring lane? Depending on the road conditions, vehicles in neighboring lanes may be detected as well as a vehicle directly in front.</p>
	<p>Are you driving on or near a curve? When driving on a curve, braking control may be activated in response to guard rails, the angle of the steering wheel, or roadside structures.</p>

	<p>The Lead Vehicle Start Alert activates, even though there is no vehicle in front.</p>
	<p>Depending on surrounding objects, traffic environment and weather, the Lead Vehicle Start Alert may issue a warning in response to objects other than a vehicle that appear in front of your vehicle.</p>

	<p>EyeSight does not restart after a temporary stop.</p>
	<p>Are you parking in an extremely hot or cold condition? In these cases, EyeSight will maintain temporary stop until the temperature is back to normal.</p>
	<p>Are you driving in the rain with poorly performing wipers or is there an oily film on the windshield? Replace the wipers with new ones, or clean the oily film off the windshield. Are you driving in poor weather conditions with heavy rain, snow, fog, or dust? In these cases, EyeSight may temporarily stop operating while visibility is very poor.</p>
	<p>Is your vehicle subject to sunlight from the front (sunset or sunrise, etc.) or to bright headlights from oncoming vehicles at nighttime? In these cases, EyeSight may temporarily stop operating.</p>
	<p>The timing of the “Obstacle Detected” warning is sometimes earlier or sometimes later than what seems to be normal operation.</p>
	<p>The “Obstacle Detected” warning sounds when the system determines that more braking is necessary, based on conditions such as the distance from the vehicle in front and the difference in speed compared to it. As a result, timing may vary depending on how the brakes are applied in relation to the vehicle in front, and your relative speed to that vehicle.</p>
	<p>When the vehicle in front has turned off the roadway or the distance from the vehicle in front has increased, acceleration is sometimes slower or faster.</p>
	<p>Depending on the timing of when the detection of the vehicle in front is lost, EyeSight’s ability to react may be slower, causing the start of acceleration to feel delayed and braking time to feel longer than what seems to be normal operation.</p>

	<p>Cruise control is canceled automatically.</p>
	<p>Did you perform one of the following operations?</p> <ul style="list-style-type: none"> <li>• Manually depressing the brake pedal</li> <li>• Pressing the  (CRUISE) switch             <ul style="list-style-type: none"> <li>- If the  (CRUISE) switch is pressed while the cruise control is set, the cruise control will be canceled.</li> </ul> </li> <li>• Staying on a steep slope</li> <li>• Turning the steering wheel sharply</li> <li>• Unfastening the seatbelt.</li> <li>• Parking brake is applied.</li> <li>• The system may also be canceled under conditions not listed above.</li> </ul> <p>⇒ Refer to page 47 (Adaptive Cruise Control).          ⇒ Refer to page 80 (Conventional Cruise Control).</p>
	<p>Has the EyeSight system temporarily stopped?          *When the Adaptive Cruise Control function is in use.</p>
	<p>A noise occurs when automatic braking control activates.</p>
	<p>This is the sound of the automatic braking control operating - there are some mechanical components to the system, and they do occasionally make audible sounds during automatic braking control. This does not indicate a malfunction.</p>
	<p>Braking control activates frequently when driving with Adaptive Cruise Control in heavy traffic.</p>
	<p>When Adaptive Cruise Control is activated, the EyeSight system performs control based on the movement of vehicles or objects in front. As a result, acceleration and deceleration may be more frequent while the system adjusts to vehicles or objects the camera system is detecting. If it is difficult to maintain a consistent following distance under certain conditions (such as in heavy traffic, poor weather or urban environments, etc.), do not use Adaptive Cruise Control.</p>

	<p>Lane Keep Assist was unexpectedly canceled.</p>
	<p>Did you take your hands off the steering wheel? Did you just lightly put your hands on the steering wheel while driving? If the system cannot detect the steering operation of the driver, it will temporarily cancel Lane Keep Assist.</p>
	<p>Did you turn a tight corner? Lane Keep Assist does not operate while turning a tight corner.</p>
	<p>Did you perform one of the following operations?</p> <ul style="list-style-type: none"> <li>• Operating the turn signal lever</li> <li>• Operating the steering wheel to depart from a lane</li> <li>• Operating the windshield wiper in a high speed</li> <li>• Driving your vehicle at a speed less than approximately 34 MPH (55 km/h) or more than approximately 93 MPH (150 km/h)</li> <li>• Depressing the brake pedal</li> <li>• Turning on the hazard warning flasher switch</li> <li>• The system may also be canceled under conditions not listed above.</li> </ul> <p>⇒ Refer to page 59.</p>
	<p>Lane Keep Assist does not operate even though there are lane markers.</p>
	<p>Is the width of the road too narrow or too wide? To operate Lane Keep Assist, the width of the road should be between approximately 10 ft (3 m) and 15 ft (4.5 m).</p>

# MEMO