

Getting Started Guide

WRX

2024



Love. It's what makes Subaru, Subaru.



© 2023 Subaru of America, Inc. Printed in USA. All rights reserved. Contents may not be reproduced in whole or in part without prior written permission of publisher. Specifications in this Guide are based on the latest product information available at the time of publication. Some images shown are for illustration purposes only. Some equipment shown in photography within this Guide is optional at extra cost. Specific options may be available only in combination with other options. Specific combinations of equipment or features may vary from time to time, and by geographic area. Subaru of America, Inc. reserves the right to change or discontinue at any time, without notice: Prices, colors, materials, equipment, accessories, specifications, models, and packages, without incurring any obligation to make the same or similar changes on vehicles previously sold. Colors shown may vary due to reproduction and printing processes. Subaru of America, Inc. is not responsible for typographical errors.

Aha® is a registered trademark of Harman International Industries, Incorporated. Alcantara® is a registered trademark of Alcantara S.p.A., and Alcantara is produced by the Toray Group. App Store® is a registered trademark of Apple, Inc. Apple® is a registered trademark of Apple, Inc. Apple CarPlay® is a registered trademark of Apple, Inc. BBS® is a registered trademark of BBS Kraftfahrzeugtechnik, AG. Bluetooth® is a registered trademark of Bluetooth SIG, Inc. BRIN NAUB® is a registered trademark of TB Kawashima Co., Ltd. Brembo® is a registered trademark of Freni Brembo, S.p.A. Clari-Fi® is a registered trademark of Harman International Industries, Incorporated. Glympse® is a registered trademark of Glympse, Inc. Google, Android, Android Auto, and Google Play are trademarks of Google LLC. Grand Luxe® is a registered trademark of Seiren Co., Ltd. GreenEdge® is a registered trademark of Harman International Industries, Incorporated. HARMAN® is a registered trademark of HARMAN International Industries, Incorporated. Harman Kardon® is a registered trademark of Harman International Industries, Incorporated. Quantum logic™ is a trademark of Harman International Industries, Incorporated. HD Radio® is a registered trademark of iBiquity Digital Corporation. HomeLink® and the HomeLink® house icon are registered trademarks of Gentex Corporation. iHeartRadio® is a registered trademark of iHeartMedia, Inc. iPod® is a registered trademark of Apple, Inc. iTunes® is a registered trademark of Apple, Inc. Michelin® is a registered trademark of Compagnie Générale des Etablissements Michelin. Metal-Matrix Diaphragm (MMD®) is a registered trademark of Harman International Industries, Incorporated. MirrorLink™ is a trademark of Car Connectivity Consortium, LLC. Pandora® is a registered trademark of Pandora Media, Inc. Qi® is a registered trademark of Wireless Power Consortium, Inc. QR Code is a registered trademark of Denso Wave Incorporated. Subaru Solterra Connect™ is a trademark of Subaru Corporation. SACHS® is a registered trademark of ZF Friedrichshafen AG. Siri® is a registered trademark of Apple, Inc. Smart Way® is a registered trademark of the U.S. Environmental Protection Agency. Stitcher™ is a trademark of Stitcher™, Inc. TomTom® is a registered trademark of TomTom International BV. TORSEN LSD® is a registered trademark of JTEKT TORSEN North America, Inc. SiriusXM all related logos are trademarks of Sirius XM Radio Inc. and its respective subsidiaries. Other marks, channel names and logos are the property of their respective owners. All rights reserved. Ultrasuede® is a registered trademark of Toray Industries, Inc. WHAT3WORDS® is a registered trademark of WHAT3WORDS Ltd. Yelp® is a registered trademark of Yelp, Inc. Ascent, Added Security, DriverFocus, Crosstrek, Forester, Outback, StarTex and StarDrive are registered trademarks of Subaru of America, Inc. Subaru Wilderness™ logo is a trademark of Subaru Corporation. BRZ, EyeSight, Impreza, Lineartronic, Legacy, S209, Solterra, Subaru, SUBARU STARLINK, Starlink, SUBARU BOXER, tS (Design), WRX, STI, X-MODE and Wilderness are registered trademarks of Subaru Corporation.

TABLE OF CONTENTS



PURPOSE OF THIS GUIDE

WELCOME	4
IMPORTANT SAFETY INFORMATION	4
OWNER'S RESOURCES	4
IN CASE OF EMERGENCY	5
TOWING YOUR ALL-WHEEL DRIVE SUBARU	6

ENTRY AND EXIT

KEYLESS ENTRY	7
KEYLESS ACCESS WITH PUSH BUTTON START	8

INSTRUMENT PANEL

GAUGES AND WARNING LIGHTS

COMBINATION METER	12
WARNING AND INDICATOR LIGHTS	13

CONTROLS

INSTRUMENT PANEL SWITCHES (LOWER LEFT)	14
AUDIO CONTROLS	14
CRUISE CONTROL	15
ADVANCED ADAPTIVE CRUISE CONTROL	16
i SWITCH	17
LIGHT CONTROLS	18

TURN SIGNALS	20
WINDSHIELD WIPERS	20
OVERHEAD CONSOLE	21

GETTING COMFORTABLE

SEATING	22
TILT AND TELESCOPIC STEERING COLUMN	24
POWER EXTERIOR MIRRORS ..	24
POWER WINDOWS	25
POWER MOONROOF	25
CLIMATE CONTROL	26
ACCESSORY CONNECTIONS ..	31

OPERATING THE VEHICLE

IGNITION SWITCH	32
PUSH-BUTTON IGNITION SWITCH	32
STARTING THE VEHICLE	32
DRIVING THE VEHICLE	33
ELECTRONIC PARKING BRAKE (EPB)	36
TURNING OFF THE VEHICLE ..	38

REFUELING

FUEL FILLER LID	39
FUEL SPECIFICATIONS AND CAPACITY	39

TABLE OF CONTENTS

PASSENGER/CARGO AREAS

FOLDING THE REAR SEATS . . .	40
CHILD SAFETY LOCKS	40
LATCH/ANCHOR	41
REAR SEAT REMINDER	42
INTERNAL SAFETY TRUNK	
RELEASE WITH SELF-	
ILLUMINATING HANDLE	43
FLAT TIRE REPAIR KIT	43

ENGINE COMPARTMENT

2.4 L TURBO ENGINE	44
------------------------------	----

ADDITIONAL SPECIFICATIONS

NEW VEHICLE BREAK-IN	45
ENGINE OIL SPECIFICATIONS & CAPACITIES	45
ROOF MOLDING AND CROSSBAR	46
TRAILER TOWING CAPACITY . .	46
TIRE PRESSURE MONITORING SYSTEM (TPMS)	46

STARLINK OVERVIEW

OVERVIEW OF YOUR MULTIMEDIA SYSTEM	48
BUTTONS	49
TOUCHSCREEN	50
STEERING WHEEL CONTROLS .	51
VOICE RECOGNITION	51

STARLINK HOME

HOME SCREEN ICONS	53
REARRANGING ICONS	54
ADDING SHORTCUTS	55

DRIVER PROFILE

CREATING A DRIVER PROFILE .	57
VALET MODE	60

MULTIMEDIA

RADIO	64
MEDIA	70

PHONE

PAIRING A PHONE	71
PAIRING AN ANDROID PHONE	72
PAIRING AN IPHONE	78
MAKING A CALL	84

RECEIVING A CALL	85
TEXT MESSAGES	86

APPS

SUBARU STARLINK® IN-VEHICLE APPS	87
MYSUBARU	88

MAPS (if equipped)

MAPS OVERVIEW	90
-------------------------	----

STARLINK SAFETY AND SECURITY

SAFETY AND SECURITY OVERVIEW	91
ENROLLMENT	92
MYSUBARU INTEGRATION . . .	92
SUBARU STARLINK® WI-FI HOTSPOT	93

SETTINGS AND UPDATES

SETTINGS AND UPDATES OVERVIEW	94
SOUND	95
PHONE	96
MAPS/NAVIGATION	96
CLOCK	97

EYESIGHT

EYESIGHT® OVERVIEW	98
OPERATION	99
FUNCTIONS	99
STEERING WHEEL CONTROLS	107
EYESIGHT® ASSIST MONITOR (EAM)	108
LANE DEPARTURE WARNING AND PRE-COLLISION BRAKING SYSTEM OFF	109

DRIVER ASSIST TECHNOLOGIES

REAR-VISION CAMERA	111
BLIND SPOT DETECTION (BSD) / REAR CROSS TRAFFIC ALERT (RCTA)	111
HIGH BEAM ASSIST (HBA) . . .	114
STEERING RESPONSIVE HEADLIGHTS (SRH)	114
REVERSE AUTOMATIC BRAKING (RAB)	115

TABLE OF CONTENTS

CARE AND LIMITATIONS

STEREO CAMERA PRECAUTIONS	116
WINDSHIELD GLASS AND DASHBOARD	116

FRONT VIEW

WRX	117
---------------	-----

EYESIGHT DISCLAIMER

EYESIGHT® DISCLAIMER	118
------------------------------	-----

HOW TO APPENDIX

HOW TO OVERVIEW	119
SETTING THE CLOCK	119
WI-FI	123
MAPS	126
FIRMWARE AND SOFTWARE UPDATES	143

INDEX	144
------------------------	-----

PURPOSE OF THIS GUIDE

WELCOME

Congratulations on choosing a Subaru WRX and welcome to the Subaru family!

Subaru is more than a car company™. We are committed to making the world a better place, and the Subaru Love Promise is our vision to show love and respect to all people at every interaction with Subaru. We believe in building lifelong relationships with our customers, earning your trust and exceeding your expectations by providing customer service with integrity and compassion.

This Getting Started Guide will introduce you to your new Subaru WRX by providing information on the basic operation and key features of your Subaru as well as the STARLINK® and EyeSight® systems in your vehicle.

IMPORTANT SAFETY INFORMATION

The Getting Started Guide is not intended as a substitute for your Owner's Manuals. We strongly encourage you to review your Vehicle, STARLINK®, and EyeSight® Owner's Manuals to ensure complete understanding.

As part of routine maintenance and continuous improvement, Subaru releases updates to the firmware and software in your vehicle. Following the installation of these updates, the screens and menus in your vehicle may differ from what appears in this guide.

 For the most current information on firmware and software updates, please refer to the "Owner's Resources" in the following section or contact your Subaru Retailer.

OWNER'S RESOURCES

If you're having difficulty using any of the functions outlined in this guide, or want to learn more, you can get additional information from the following sources:

Your Subaru Owner's Manuals:

Located in the glovebox

Online Subaru Owner's Resources:

www.subaru.com/owners

Subaru Customer Support:

www.subaru.com/customer-support

1-800-782-2783 (1-800-SUBARU3)



Scan to learn more about Owner's Resources.



Scan to learn more about Customer Support.



Scan to get the MySubaru App.

PURPOSE OF THIS GUIDE

IN CASE OF EMERGENCY

SUBARU STARLINK® Safety and Security (if equipped, subscription required)

SOS Emergency: Press the red “SOS” button on the overhead console in the event of an emergency to speak with a SUBARU STARLINK® Customer Care Advisor.

Enhanced Roadside Assistance: Press the blue “i” button on the overhead console or select the “MySubaru” button and then choose “Roadside Assistance” on the multimedia system. The “i” button also connects to the Concierge service, if subscribed.



SOS and Roadside Assistance Buttons

i For more information, please refer to “Safety and Security Overview” on page 91 in this Getting Started Guide or “Introduction” in your SUBARU STARLINK® Safety and Security Owner’s Manual. Not available in all states. See Retailer for details.

Subaru Roadside Assistance

Subaru Roadside Assistance:
1-800-261-2155

Subaru Roadside Assistance is free and standard on your Subaru; there are no forms to complete. This service is available anytime during the 3-year/36,000-mile Subaru Limited Warranty, whichever comes first. See your Subaru Retailer for details and refer to the Roadside Assistance guide in the owner’s information kit for the details on this coverage. A Subaru Roadside Assistance decal has been affixed to the driver’s door window.

Roadside assistance helps with:

- Towing to the nearest authorized Subaru Retailer if you cannot safely drive your Subaru
- Jump-start if your battery is dead
- Gasoline delivery if you run out of gas
- Emergency lockout service
- National Subaru Retailer locator service, with phone numbers and location of the nearest Subaru Retailer anywhere in the U.S. or Canada

NOTE: Specifically excluded from Subaru Roadside Assistance coverage are service requests or claims resulting from: accidents, vandalism, acts of God, violation of any laws, or vehicle modifications not recommended by the manufacturer.

PURPOSE OF THIS GUIDE

TOWING YOUR ALL-WHEEL DRIVE SUBARU

Since Subaru Symmetrical All-Wheel Drive distributes power to all four wheels, improper towing may damage your AWD system. The best way to tow your WRX is with a flatbed truck by your Subaru Retailer or a commercial towing service.

 For more information, please refer to “In Case of Emergency” in your Owner’s Manual.

KEYLESS ENTRY

1 Lock/Arm

- Press the lock/arm button to lock the doors and trunk and to activate the security alarm. A chirp sounds and the hazard warning lights flash once.
- If any of the doors are not fully closed, five rapid chirps sound and the hazard warning lights flash to alert you.
- Press the lock/arm button three times to activate the vehicle finder function. If you are within 30 feet of your Subaru, the horn sounds once, and the hazard warning lights flash three times.

2 Unlock/Disarm

- Press the unlock/disarm button once to unlock the driver's door. Two chirps sound and the hazard warning lights flash twice. To unlock all the doors and the trunk, briefly press the button twice.
- The interior lights will illuminate when you press the unlock/disarm button if the interior light switch is set to the "DOOR" position on the overhead console.

3 Trunk

- Press and hold the trunk button to open the trunk.

4 Panic Alarm

- Press the panic alarm button to sound the horn and flash the hazard warning lights.
- Press any button on the access key fob or transmitter to deactivate the panic alarm.



Transmitter



Access Key Fob

Automatic Door Locking/Unlocking

This feature allows you to set when your Subaru automatically locks or unlocks the doors through the STARLINK® Touchscreen (select "Settings", and then select the "Car" menu). The available settings are listed in the table below.

	AVAILABLE SETTINGS			
AUTO DOOR LOCK	Vehicle Speed (12 mph)	Shift into or out of PARK (SPT models)	OFF	
AUTO DOOR UNLOCK	Ignition OFF	Driver Door Open	Shift into or out of PARK (SPT models)	OFF

ENTRY AND EXIT

KEYLESS ACCESS WITH PUSH BUTTON START

(if equipped)

The Keyless Access with Push-Button Start system features the following touch-activated door locking or unlocking functions without the key ever leaving your pocket or purse. You can customize the touch-activated door locking or unlocking settings using the STARLINK[®] Touchscreen by selecting “Settings,” and then selecting the “Car” menu.

Unlocking Using Door Handles

Grip the driver’s door handle to unlock the driver’s door and the fuel filler lid. Grip the front passenger’s door handle to unlock all doors, the fuel filler lid, and the trunk. Two chirps sound and the hazard warning lights flash twice.



Door Unlock Sensor

Locking Using Door Handles

Close all the doors and the trunk and touch the door lock sensor (two lines) on either front door handle. All doors, the trunk, and the fuel filler lid lock. One chirp sounds and the hazard warning lights flash once.



Door Lock Sensor

Unlocking the Trunk

Press the trunk opener button to unlock and open the trunk. Two chirps sound and the hazard warning lights flash twice.



Trunk Opener Button

INSTRUMENT PANEL

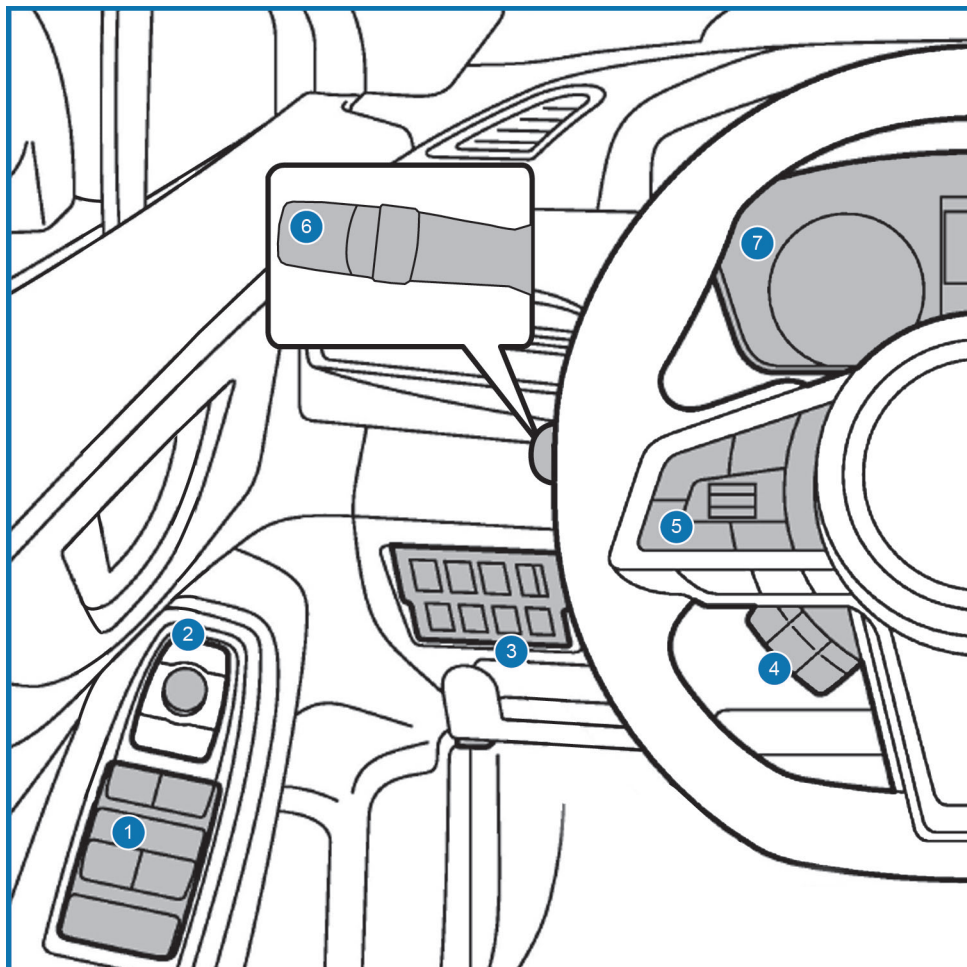

- ① Power Windows (p. 25)
- ② Power Exterior Mirrors (p. 24)
- ③ Instrument Panel Switches (p. 14)
- ④ i Switch (p. 17)
- ⑤ Audio Controls (p. 14)
- ⑥ Light Controls (p. 18)
- ⑦ Combination Meter (p. 12)

INSTRUMENT PANEL

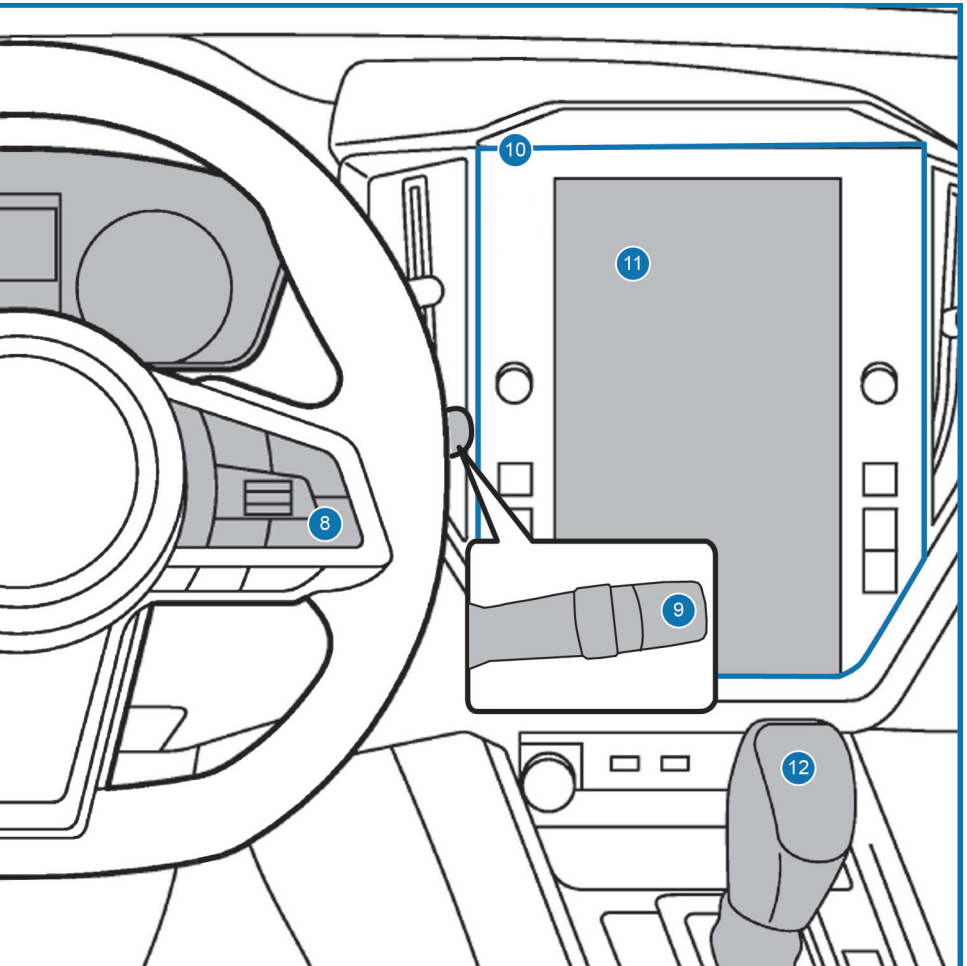

- ⑧ Cruise Control or Advanced Adaptive Cruise Control (p. 15)
- ⑨ Windshield Wipers (p. 20)
- ⑩ Center Information Display (p. 48)
- ⑪ SUBARU STARLINK® Multimedia Touchscreen (p. 48)
- ⑫ Shifter (MT) or Select Lever (SPT) (p. 33)

GAUGES AND WARNING LIGHTS

COMBINATION METER

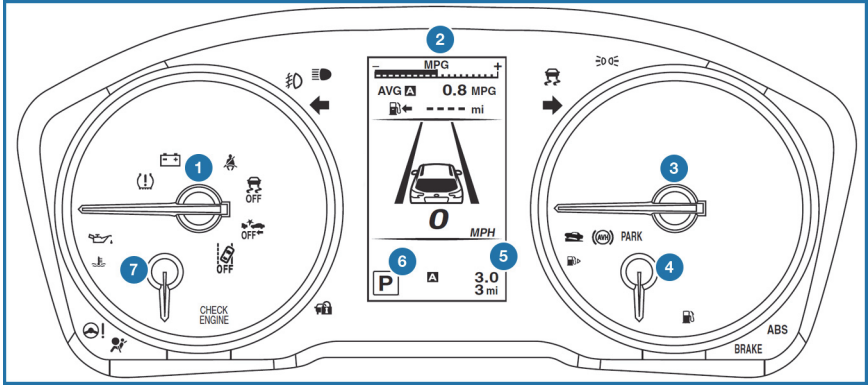



- 1** Tachometer
- 2** Combination Meter Display (CMD)
- 3** Speedometer
- 4** Fuel gauge
- 5** Trip meter and odometer
- 6** Select lever/gear position indicator
- 7** Engine coolant temperature gauge



GAUGES AND WARNING LIGHTS

WARNING AND INDICATOR LIGHTS

Red lights indicate immediate attention is required. Some examples are:

		BRAKE / (!)
Seatbelt warning	Door open indicator	Brake system warning

Yellow lights indicate caution. Some examples are:

		
Low fuel	Engine low oil level warning	Tire pressure warning

Green and **blue** lights are for information. Some examples are:

		
Headlight indicator	Auto Vehicle Hold	High beam indicator

CONTROLS

INSTRUMENT PANEL SWITCHES (LOWER LEFT)

The switches in the lower left of the instrument panel allow you to control convenient features. The switches include:

- 1 Trunk lid release
 - 2 Illumination Brightness (p. 19)
 - 3 Vehicle Dynamics Control OFF
- ↑ For more information, please refer to your Owner's Manual.



AUDIO CONTROLS

- 1 Presets/Skip
 - 2 Volume
 - 3 Source
 - 4 Voice Recognition
 - 5 Call/End
- ↑ For more information about your audio system and controls, please refer to page 51 in this Getting Started Guide or "Quick Guide" in your STARLINK® Owner's Manual.



CRUISE CONTROL (if equipped)

- 1 Cruise Control On/Off
 - 2 Resume (RES)/Increase Speed and Set (SET)/Decrease Speed
 - 3 CANCEL Button
- 1 For more information, please refer to “Starting and Operating” in your Owner’s Manual.



CONTROLS

ADVANCED ADAPTIVE CRUISE CONTROL (if equipped)

- 1 Adaptive Cruise Control On/Off
- 2 Lane Centering
- 3 Increase Distance
- 4 Decrease Distance
- 5 Resume (RES)/Increase Speed and Set (SET)/Decrease Speed
- 6 SI-Drive (if equipped) or Drive Mode Select (GT)

For more information on the Advanced Adaptive Cruise Control switches, please refer to page 107 in this Getting Started Guide or “Advanced Adaptive Cruise Control” in your EyeSight® Owner’s Manual.

For more information on SI-Drive, please refer to page 34 in this Getting Started Guide or “Starting and Operating” in your Owner’s Manual.

For more information on Drive Mode Select, please refer to page 35 in this Getting Started Guide or “Starting and Operating” in your Owner’s Manual.



Advanced Adaptive Cruise Control with SI-Drive



Advanced Adaptive Cruise Control with Drive Mode Select

i SWITCH

The “i” switch and arrows allow you to cycle through useful driving information in the Combination Meter Display (CMD) such as fuel consumption, driving time, speed, and tire pressure, among others. You can change the information displayed by using the up and down arrows.

If there are some useful messages, such as vehicle information or warning screens, they will interrupt the current screen, and appear on the display, accompanied by a beep. If such a screen is displayed, take proper action according to the message shown on the screen. The warning screen will return to the original screen after a few seconds. Important vehicle information or warning screens may be able to be displayed when the “i” appears in the CMD. Pull and hold the “i” switch to access the important messages. Use the arrows to cycle through multiple messages.

 For more information about the Combination Meter Display, please refer to “Instruments and Controls” in your Owner’s Manual.

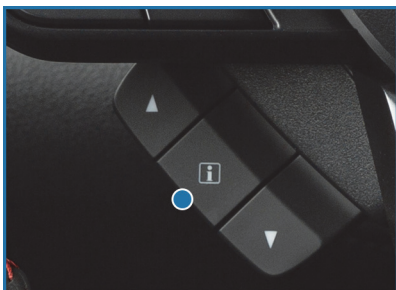

CONTROLS

LIGHT CONTROLS

- 1 AUTO:** Rotate the end of the lever to set your headlights to automatically turn on or off, depending on the level of light outside. When in the “AUTO” position, the headlights will automatically turn on when the windshield wipers operate several times.

NOTE: The sensitivity of the automatic headlights can be adjusted through the STARLINK® multimedia display.

- 2 Parking Lights:** Rotate the end of the lever to turn on the instrument panel illumination, parking lights, side marker lights, tail lights, and license plate lights.



- 3 Headlights:** Rotate the end of the lever to turn on the headlights, instrument panel illumination, parking lights, side marker lights, tail lights, and license plate lights. To flash the headlights, pull the lever toward you, and then release. The high beams will stay on as long as you hold the lever.

- 4 High Beams:** Push the lever forward and release to change from low beam to high beam. Pull the lever rearward and release to return to low beam. When set to the “AUTO” position, pushing the lever forward also activates the High Beam Assist (HBA) system.

- 5 Fog Lights:** If equipped, rotate the dial to turn on the fog lights when the headlights are on low beams in the “” or “AUTO” position.



Illumination Brightness

When the light controls are on (in the “”, “”, or “AUTO” position), and ambient light is low, rotating the illumination brightness dial on the instrument panel upward will make the instrument panel illumination brighter. When the dial is fully rotated upward (dots aligned), the instrument panel illumination stays at full brightness. Rotating the dial downward dims the instrument panel illumination.





Illumination Brightness Dial

When the ambient light is bright, the illumination brightness is set to the maximum regardless of the position of the control dial.

 For more information, please refer to “Instruments and Controls” in your Owner’s Manual.

Daytime Running Lights

The daytime running lights automatically turn on when the engine is running, the parking brake is fully released, the select lever is out of the “P” position (SPT models), and the light switch is set to Off, “AUTO” (if equipped), or “”. Always turn on the headlights when it’s dark outside by rotating the dial to the “” or “AUTO” position.

CONTROLS

TURN SIGNALS

Pushing the turn signal lever up/down and releasing it activates the turn signal. The lever then returns to its original position. To cancel the turn signal push and release the turn signal lever slightly in the opposite direction of the active turn signal. Your Subaru also has a one-touch lane changer feature: push slightly up and release to signal a right lane change or push slightly down and release to signal a left lane change.



WINDSHIELD WIPERS

- 1 Intermittent:** Push the wiper control lever down one position for intermittent operation. When the lever is in the intermittent position, you can rotate the dial to adjust the operating interval of the wipers.
- 2 Low Speed:** Push the wiper control lever down two positions for low speed wiper operation.
- 3 High Speed:** Push the wiper control lever down three positions for high speed wiper operation.
- 4 Mist:** Push the wiper up from the off position for a single wipe.
- 5 Windshield Washer:** Pull the lever toward you to wash the windshield. The washer will spray and the wipers will operate while you pull the lever.

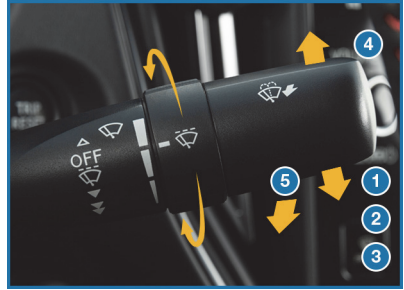

OVERHEAD CONSOLE

- 1 SOS Emergency Assistance (if equipped):** Press the “SOS” button to connect with a SUBARU STARLINK[®] Customer Care Advisor (subscription required). Press and hold the button for about two seconds to cancel the call.

↑ For more information, please refer to page 91 in this Getting Started Guide or “Introduction” in your SUBARU STARLINK[®] Safety and Security Owner’s Manual.

- 2 Enhanced Roadside Assistance (if equipped):** Press the “i” button to connect with a SUBARU STARLINK[®] Roadside Assistance Provider (subscription required). Press and hold the button for about two seconds to cancel the call. The “i” button is also used for Concierge services, if subscribed.

↑ For more information, please refer to page 91 in this Getting Started Guide or “Introduction” in your SUBARU STARLINK[®] Safety and Security Owner’s Manual.

- 3 Automatic Illumination:** When the switch is in the “DOOR” position, the map lights illuminate when any door is opened, the doors are unlocked using the remote keyless entry system or keyless access function, or the ignition is turned from ON or ACC to LOCK/OFF.

- 4 Map Lights:** Press a map light to turn it on or off.

- 5 Power Moonroof:** Use these switches to operate the power moonroof.

↑ For more information, please refer to page 25 in this Getting Started Guide or “Keys and Doors” in your Owner’s Manual.



GETTING COMFORTABLE

SEATING

Manual Seats

- 1 Forward/Backward:** Pull the lever below the seat up and slide the seat forward or backward. Release the lever and make sure the seat is locked into place.
- 2 Seat Height (Driver's Seat):** Pulling up or pushing down on the lever will raise or lower the seat cushion.
- 3 Recline Seatback:** Pull the lever up to adjust the seatback. Release the lever and make sure the seatback is locked into place.



Manual Seat Levers

Power Driver's Seat (if equipped)

- 1 Seat Position:** Moving the switch forward or backward will adjust the seat in that direction. Pulling up or pushing down on the back of the switch will adjust the seat height up or down. Pulling up or pushing down on the front of the switch will adjust the angle of the seat cushion.
- 2 Recline Seatback:** Moving the top of the switch forward or backward will adjust the angle of the seatback.
- 3 Lumbar Support (if equipped):** Press the front side of the switch to increase lower back support. Press the rear side of the switch to decrease support.



Power Seat Controls

GETTING COMFORTABLE

Head Restraint Adjustment

Pull the head restraint up to raise it to the first position. To raise it farther, press the release button on top of the seatback while raising the head restraint. To lower the head restraint, push it down while pressing the release button. Each head restraint should be adjusted so that the center of the head restraint is closest to the top of the occupant's ears.

The angle of the front head restraints can be adjusted by tilting them forward. You will hear a click when the restraint locks in place. Pulling the head restraint as far forward as it will go allows it to return to the fully upright position.

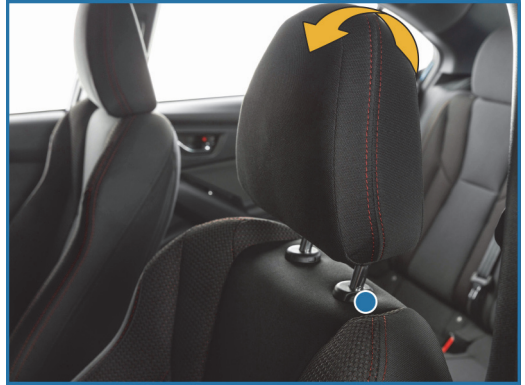

Release Button and Head Restraint Adjustment

Seatbelt Adjuster

To keep yourself comfortable and safe, always position the seatbelt adjuster so the shoulder belt passes over the middle of your shoulder without touching your neck. Pull the tab out and slide the adjuster up or down to set the position. Release the tab and make sure the adjuster is locked in place.



Seatbelt Adjustment Tab

GETTING COMFORTABLE

TILT AND TELESCOPIC STEERING COLUMN

You can adjust both the height and lengthwise position of the steering wheel. Pull the lever on the steering column down firmly to unlock, and then adjust the position of the steering wheel. Push the lever firmly back up to lock the steering wheel in place.



Steering Column Unlock

POWER EXTERIOR MIRRORS

The power mirror knob works with the ignition in the "ON" or "ACC" position. Turn the knob to "L" (left side) or "R" (right side) to select a mirror. Push the knob in the direction you want to move the mirror. Turn the knob back to the center position when finished.



Power Mirror Knob

POWER WINDOWS

To open or close a window, partially press down or pull up and hold the corresponding switch. The front windows have a one-touch auto up/down function, and the rear windows may also have auto up/down function, if equipped. Fully press down or pull up and release to automatically open or close a one-touch window.



Power Window Switches

POWER MOONROOF (if equipped)

With the ignition in the “ON” position, you can tilt and slide the moonroof.

Tilting the Moonroof

- 1 Opening:** Press, briefly hold, and release the switch to automatically tilt the moonroof.
- 2 Closing:** Press and hold the switch to lower the moonroof.

Sliding the Moonroof

- 3 Opening:** Press, briefly hold, and release the switch to open the moonroof. To pause the moonroof halfway, press either side of the switch.
- 4 Closing:** Press, briefly hold, and release the switch to close the moonroof. To pause the moonroof halfway, press either side of the switch.



GETTING COMFORTABLE

CLIMATE CONTROL

Dual 7-Inch Automatic Climate Control

The climate control buttons appear on the lower portion of the bottom display and are similar to the 11.6 inch display.



- 1 Climate Control On/Off Button
- 2 Climate Control Mode Indicator
- 3 Customizable Icon
- 4 Fan Speed Indicator
- 5 Heated Seat Button (if equipped)

Select the Climate Control Mode Indicator to display the climate control screen. On this screen, you can adjust the climate control mode, airflow mode, and fan speed.



On the next screen, select the Set Temperature Indicator to display the temperature control screen. You can adjust the temperature using the red and blue arrow buttons or the temperature control slider bar. The temperature displays at the top of the screen.

11.6-Inch Automatic Climate Control



The climate control system is equipped with convenient and customizable features. In automatic control mode, set your desired temperature and let the system make the adjustments for you. At any time, you can manually take control of the climate settings. You can also set separate temperatures for the driver and front passenger.

- 1 Climate Control On/Off Button:** This button turns the climate control on and off.
- 2 Temperature Control Buttons:** Push the red arrow button to increase the temperature or the blue arrow button to decrease the temperature. The temperature appears on the screen. You can also adjust the setting via touchscreen by selecting the climate control mode indicator and using the arrows or sliding the temperature control bar. You can set separate temperatures for the driver's side and passenger's side.
- 3 Rear Window Defogger Button:** Press this button to turn on the rear window defogger. If equipped, the outside mirror defogger and windshield wiper deicer will also activate. It will automatically turn off after about 15 minutes. If the window clears before then, press the button again to turn it off. You can customize this function for continuous operation through the STARLINK® touchscreen by selecting "Settings", then "Car".
- 4 Defroster Button:** Press the defroster button to defrost or dehumidify the windshield and front door windows.

NOTE: When the defrost mode is selected, the air conditioning operates to defrost the windshield more quickly. However, the indicator on the air conditioner button may not illuminate.

GETTING COMFORTABLE

- 5 Customizable Button:** This button can be customized to be one of a number of buttons: A/C, Max A/C, Auto, Recirculation, or SYNC. On the Home Screen, select "Settings", "General", and then "Climate Control" to customize.
- 6 Fan Speed Control:** Select your preferred fan speed by using the fan speed arrow buttons on the climate control screen.
- 7 Heated Seat Button (if equipped):** Select this button to turn on the driver/passenger heated seat. Each time you press the button, the mode will change as follows: High, Mid, Low, Off. Yellow indicators illuminate indicating the level.
- 8 Climate Control Mode Indicator:** Select the Climate Control Mode Indicator to control the air flow mode, temperature, SYNC, A/C, Max A/C, Auto mode, and recirculation.



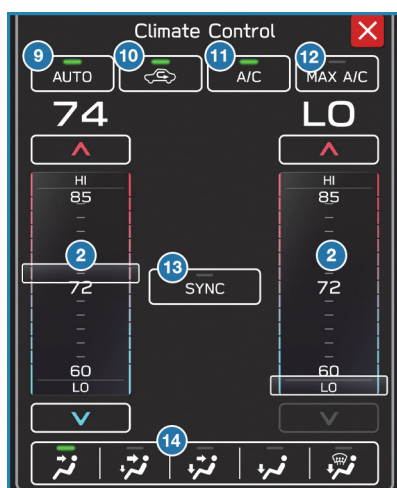



- 9 AUTO:** Select this button to activate automatic climate control operation. Set your preferred temperature, and the system will automatically control fan speed, airflow mode, air inlet selection, and air conditioner operation.
- 10 Air Inlet Selection Button:** Select this button to activate recirculation mode and recirculate the interior air inside the vehicle. Recirculation mode is helpful when driving on a dusty road or when you want cooling performance to increase. Select the button again to return to outside air circulation mode and allow outside air to be drawn into your Subaru.



NOTE: To prevent windshield fogging, do not remain in the recirculated mode for an extended period of time.

- 11 A/C:** Select this button to activate or deactivate the air conditioning.
- 12 MAX A/C Button:** Select this button for quickest cooling.
- 13 SYNC Button:** Select this button to synchronize the driver's and passenger's temperatures to the driver's temperature control. Select the SYNC button again or operate the passenger side temperature controls to cancel SYNC mode and adjust each side individually.
- 14 Airflow Mode Selection Buttons:** Press the button to select the desired airflow mode. The selected mode air flow mode is shown on the display.

GETTING COMFORTABLE

ICON	MODE	FUNCTION
	Ventilation	Instrument panel outlets
	Ventilation 2	Instrument panel outlets and less foot outlets than bi-level
	Bi-Level	Instrument panel outlets and foot outlets
	Feet	Foot outlets, both side outlets of the instrument panel and some through windshield defroster outlets
	Feet-Defrost	Windshield defroster outlets, foot outlets and both side outlets of the instrument panel
	Defrost	Windshield defroster outlets and both side outlets of the instrument panel

NOTE: The defroster button is used to activate the defrost airflow mode.

Operation in Automatic Mode

When using automatic mode, the fan speed, airflow mode, air-inlet control and air conditioning operation are controlled automatically. To activate:

1. Select the climate control mode indicator, and then select the "AUTO" button.
2. Set your preferred temperature.

If you operate the fan speed control or the airflow mode, press the defroster button, or turn on Max A/C mode, the AUTO indicator will turn off and you can then manually control the system as desired. To change the system back to auto mode, select the "AUTO" button again.

GETTING COMFORTABLE

Remote Engine Start with Climate Control (if equipped)



This feature can also be set through [MySubaru.com](https://www.mysubaru.com) or the **MySubaru App**



MySubaru App



MySubaru.com

You can remotely start your Subaru and adjust the temperature using the STARLINK® Safety and Security features through the **MySubaru App** (subscription required). Please refer to “SUBARU STARLINK Features” in your SUBARU STARLINK® Safety and Security Owner's Manual for a list of required vehicle conditions for this feature.

Heated Seats (if equipped)



There are separate buttons for the driver and passenger heated seats. Select the heated seat button located on the climate control screen. Each time you press the button the mode will change as follows: High, Mid, Low, and Off. The indicators illuminate indicating the level.

ACCESSORY CONNECTIONS

1 Power Outlets:

Power outlets (12V) are located below the Center Information Display and in the center console storage compartment. Electrical power is available for use with in-vehicle electrical appliances with a maximum power rating of 120W. These outlets cannot be used to connect to the SUBARU STARLINK® multimedia system.



Connection Ports

i For more information, please refer to “Interior Equipment” in your Owner’s Manual.

2 Auxiliary Input Jack:

The 3.5mm auxiliary input jack is located below the Center Information Display. You can connect a portable music player to the auxiliary jack and hear the music stored on it through your Subaru’s speakers. Press the “Source” button located on the steering wheel or the “Media” button on the touchscreen to select the auxiliary mode.

i For more information, please refer to page 70 in this Getting Started Guide or “Audio” in your STARLINK® Owner’s Manual.

3 USB-C Port: If equipped, USB-C charge ports are located below the Center Information Display and on the rear center console. The USB-C ports provide charging (DC 5 V / 3.0 A) to devices.

4 USB-A Port: A USB-A port is located below the Center Information Display and, if equipped, on the rear center console. You can connect a variety of USB-equipped devices to the front port, such as portable music players or smartphones, to enjoy your favorite music or connect to Apple CarPlay® or Android Auto™. The USB-A port(s) provide charging (DC 5 V / 2.4 A) to devices. The port on the rear center console is for charging only.

i For more information, please refer to page 70 in this Getting Started Guide or “Audio” in your STARLINK® Owner’s Manual.

i For more information and step-by-step set up instructions for Android Auto™ and Apple CarPlay®, please refer to page 87 for Android Auto™ and page 87 for Apple CarPlay®.

OPERATING THE VEHICLE

IGNITION SWITCH

The ignition switch has four positions:

LOCK: You can only insert or remove the key in this position.

ACC (Accessory): Provides power to the audio system and accessory power outlets.

ON: All electrical systems are available. The key returns to this position after starting the engine.

START: Turn the key to this position to start the engine.

PUSH-BUTTON IGNITION SWITCH (if equipped)

Each time you press the ignition switch without depressing the brake pedal (or clutch pedal for manual transmission vehicles), the ignition position will change as follows: ACC, ON, OFF.

ACC (Accessory): Provides power to the audio system and accessory power outlets. Orange indicator illuminates.

ON: All electrical systems are available. Orange indicator illuminates.

OFF: Power off and indicator off.

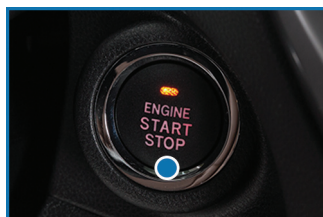

STARTING THE VEHICLE

Without Push-button Ignition

To start the engine:

1. Make sure the select lever is in the “P” position (or neutral position and depress the clutch for manual transmission vehicles).
2. Using the key, turn the ignition switch to “START”.

NOTE: Do not depress the accelerator pedal. Release the key as soon as the engine starts.

With Push-button Ignition

To start the engine:

1. Sit in the driver’s seat with the access key fob.
2. Make sure the select lever is in the “P” position or neutral for manual transmission vehicles.
3. Depress the brake pedal (and clutch pedal for manual transmission vehicles).
4. When the Engine START/STOP button indicator turns green, briefly press and release the Engine START/STOP button.

DRIVING THE VEHICLE

6-Speed Manual Transmission (if equipped)

This manual transmission is a fully synchronised 6-forward and 1-reverse speed transmission. To shift into the “R” position, raise and hold the slider ring, move the lever into the “R” position, then release the slider ring. Only pull the slider ring up when shifting into reverse gear.



Subaru Performance Transmission (if equipped)

The Subaru Performance Transmission (SPT) is electronically controlled and provides two different driving modes: normal and manual.

Normal Mode

When the select lever is in the “D” (Drive) position, the transmission is in normal shift mode. The select lever position indicator in the Combination Meter Display (CMD) shows “D” and the transmission automatically shifts into a suitable forward gear.

Manual Mode

In manual mode, you select the desired gear position to obtain necessary acceleration and engine braking. Move the select lever left from the “D” position into the “M” position to select manual mode. The gear position indicator in the Combination Meter Display (CMD) shows the currently selected gear. Arrow-shaped indicators show when upshifting or downshifting is available. To shift gears, use the paddle shift control switches behind the steering wheel.



OPERATING THE VEHICLE

Paddle Shift Control Switches (if equipped)

You can shift gears using the paddle shift control switches. To upshift to the next higher gear, pull the “+” paddle on the right toward you. To downshift to the next lower gear, pull the “-” paddle on the left toward you.

You can temporarily shift gears even when the select lever is in the “D” position by pulling either the “+” or “-” paddle toward you. In this case, the gear position indicator light illuminates and shows the current gear.



SI-Drive (if equipped)

SI-Drive has 3 modes; Intelligent (I), Sport (S) and Sport Sharp (S#). Each mode is designed for different types of driving:

- **Intelligent:** The Intelligent (I) mode provides well balanced performance with greater fuel efficiency and smooth driveability without stress. Power delivery is moderate during acceleration for maximum fuel efficiency.
- **Sport:** The Sport (S) mode provides the engine power desired by those who want to make the driving experience their own personal adventure.
- **Sport Sharp:** The Sport Sharp (S#) mode offers an exhilarating level of engine performance and control. The throttle becomes more responsive regardless of the engine speed. Delivering maximum driving enjoyment, this mode is ideal for driving on twisting roads and for merging or overtaking other vehicles on the freeway with confidence.



Operating SI-Drive

The control switches for SI-Drive are on the right side of the steering wheel. The Sport (S) mode is automatically selected when the ignition switch is turned to the ON position.

To select Sport (S) mode when in a different mode, press the “S/I” button. To select Sport Sharp (S#) mode when in a different mode, select the “S#/I” button. To select Intelligent (I) mode, press the “S/I” button when in Sport (S) mode, or press the “S#/I” button when in Sport Sharp (S#) mode.

OPERATING THE VEHICLE

Drive Mode Select (if equipped)

The Drive Mode Select function allows you to customize the drive mode, characteristics of the engine, steering, and suspension. Operate the Mode switch or INDIVIDUAL switch to select among five drive modes:

- **Comfort:** Comfort mode emphasizes riding comfort in the driving characteristics of the vehicle. The air conditioner also has a gentler setting with comfort mode activated.
- **Normal:** Normal mode combines stress-free driving performance with low fuel consumption. It is suitable for regular daily driving.
- **Sport:** Sport mode improves driving performance and achieves both sportiness and riding comfort. It is suitable for cruise driving in the high speed range.
- **Sport +:** Sport + mode emphasizes response rather than riding comfort. It is suitable for driving in the mountains and accelerating to pass.
- **INDIVIDUAL:** Each item can be set on the Center Information Display according to your preference.

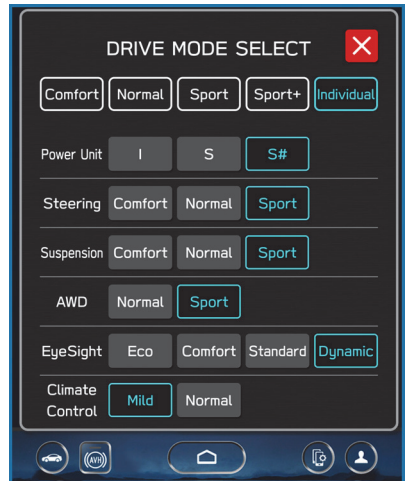

Customizing INDIVIDUAL mode

To customize the INDIVIDUAL mode, follow these steps:

- 1 Select the Car Settings icon on the Center Information Display.
- 2 In the Vehicle Control menu select "DRIVE MODE SELECT." Customize each setting to your preference in the individual tab.



OPERATING THE VEHICLE

Operating Drive Mode Select

- 1 INDIVIDUAL Switch
- 2 MODE Switch

Sport mode is automatically selected when the push-button ignition switch is turned to the "ON" position. Each time the MODE switch is pressed, the mode changes in the following order: Sport +, INDIVIDUAL, Comfort, and Normal. The current mode is displayed on the Combination Meter and Center Information Display. Press the INDIVIDUAL switch to change directly to INDIVIDUAL mode. You can also operate the Center Information Display to select the setting by using the car settings icon.

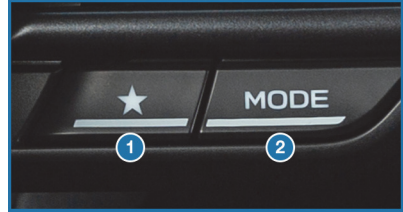

ELECTRONIC PARKING BRAKE (EPB) (if equipped)

To apply the parking brake, depress the brake pedal and pull the parking brake switch up. The indicator light on the parking brake switch will illuminate and "PARK" will appear in the Combination Meter.

To release the parking brake manually, depress the brake pedal and push the parking brake switch down with the ignition in the "ON" position.

To automatically release the parking brake, gently press the accelerator pedal.



NOTE: Automatic parking brake release will not work unless all the doors are closed and your seatbelt is fastened.

OPERATING THE VEHICLE

Auto Vehicle Hold (AVH) (if equipped)

Auto Vehicle Hold gives your feet a break by automatically holding your Subaru in place when at a complete stop, such as at a traffic signal, even after you release the brake pedal.

To turn on Auto Vehicle Hold:

- 1 Select the car settings icon.
- 2 In the Vehicle Control menu, select “Auto Vehicle Hold (AVH)” to activate the function.

When the Auto Vehicle Hold function is turned on, the indicator light in the combination meter will illuminate.

While your Subaru is being held by this function, the indicator in the combination meter will flash. The function is canceled when you depress the accelerator pedal or the brake pedal.

Select “Auto Vehicle Hold (AVH)” again to turn it off. The function works when the select lever is in a position other than the “P” position.

NOTE:

- For this system to work, the driver’s door must be closed and your seatbelt must be fastened.
- Make sure to turn off this function before entering an automatic car wash.



ICON	
Illuminated Auto Vehicle Hold ON	Flashing Auto Vehicle Hold IN OPERATION

OPERATING THE VEHICLE

TURNING OFF THE VEHICLE

Without Push-button Ignition

To stop the engine:

1. Stop your Subaru completely.
2. Move the select lever to the “P” position or set the parking brake for manual transmission vehicles.
3. Turn the ignition switch to LOCK/OFF. For manual transmission vehicles, it is recommended to leave the vehicle in gear (1st gear for an upgrade and reverse for a downgrade).

NOTE: Windows equipped with a one-touch auto up/down function will remain active for about 40 seconds or until a front door is opened, whichever occurs first.

With Push-button Ignition

To stop the engine:

1. Stop your Subaru completely.
2. Move the select lever to the “P” position or set the parking brake for manual transmission vehicles.
3. Press the ignition switch to stop the engine. For manual transmission vehicles, it is recommended to leave the vehicle in gear (1st gear for an upgrade and reverse for a downgrade).

NOTE: Windows equipped with a one-touch auto up/down function will remain active for about 40 seconds or until a front door is opened, whichever occurs first.

FUEL FILLER LID

The fuel filler lid is located toward the rear of the passenger side. To open the lid:

1. Make sure your Subaru is completely stopped and parked. Then, turn the ignition to the off position.
2. The fuel filler lid is unlocked by using the unlock switch in the door, access key fob, or door handles.
3. Push the rear side of the lid.
4. When the lid opens slightly, open it further by hand.

While refueling, place the fuel filler cap on the cap holder inside the lid.

After refueling, put the cap back on and turn it clockwise until you hear a clicking noise. Be certain not to catch the tether under the cap while tightening.

To close the lid, press it until you hear it latch.

NOTE: The Check Engine warning light may illuminate if the fuel filler cap is not tightened properly.



Fuel Filler Lid and Cap

FUEL SPECIFICATIONS AND CAPACITY

2.4L Turbo Engine Fuel Specifications and Capacity

Fuel Octane Rating	91 AKI or higher
Ethanol Content Limit	No more than 15%
Fuel Tank Capacity	16.6 US Gallons
Low Fuel Warning Light	2.3 US Gallons Appx.

PASSENGER/CARGO AREAS

FOLDING THE REAR SEATS

First, lower the headrests. Then, pull up on the release knob until you can see the red marker at the bottom of the knob and fold down the seats.

To return the seatback to its original position, raise the seatback until it locks into place. You will no longer be able to see the red marker at the bottom of the knob when the seat is locked.



Seat Release Knob

CHILD SAFETY LOCKS

The child safety locks are located on the inside edges of the rear doors. In the locked position, the rear doors can only be opened from the outside.



PASSENGER/CARGO AREAS

LATCH/ANCHOR

Your Subaru is equipped with Lower Anchors and Tethers for Children (LATCH). For maximum safety, first carefully read the LATCH system instructions from the device manufacturer, as well as the installation instructions in your Owner's Manual, to properly install the LATCH compatible restraint system. Use the appropriate seatbelts or anchorages provided in your Subaru. Children age 12 and under must properly occupy the rear seat at all times.

 For more information, please refer to "Seat, Seatbelt and SRS Airbags" in your Owner's Manual.

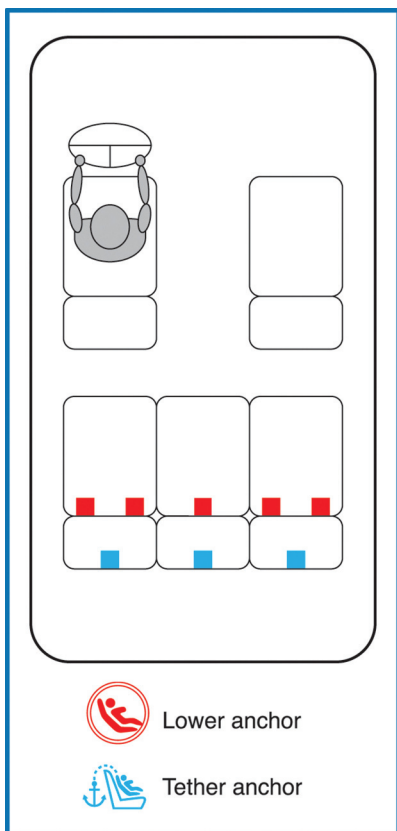

PASSENGER/CARGO AREAS

REAR SEAT REMINDER

The Rear Seat Reminder system assists you in preventing a child or pet from being left in your Subaru, prompting you to confirm the presence of passengers and cargo in the rear seats. The system monitors the opening and closing of the rear doors. It does not physically sense the presence of a child or pet.

The system activates when the rear doors are opened and closed. When the ignition switch is turned from the "ON" position to the "OFF" position, the system warns you with audible beeps and with a "Reminder, Look in Rear Seat" message in the Combination Meter Display (CMD).

You can turn the Rear Seat Reminder off in the Center Information Display (CID).



Passenger Occupant Detection and Seatbelt Reminders

To help keep your passengers safe, your Subaru has a passenger occupant detection and seatbelt reminder system for each seat, including the rear seats.

If passengers in the rear seats do not fasten their seatbelts while the ignition is in the "ON" position, the seatbelt warning lights illuminate or blink for the specific seat, and a warning chime may sound.



 For more information, please refer to "Instruments and Controls" in your Owner's Manual.

PASSENGER/CARGO AREAS

INTERNAL SAFETY TRUNK RELEASE WITH SELF-ILLUMINATING HANDLE

In the event that children or adults become locked inside the trunk, this luminescent handle allows them to open the lid from inside the trunk. To open, simply pull the yellow handle as indicated by the arrow on the handle and then push up on the lid.



FLAT TIRE REPAIR KIT

Your WRX comes equipped with a flat tire repair kit and maintenance tools.

Your vehicle is equipped with the following maintenance tools:

- 1 Flat tire repair kit
- 2 Jack
- 3 Jack handle
- 4 Wheel nut wrench
- 5 Screwdriver
- 6 Towing hook (eye bolt)

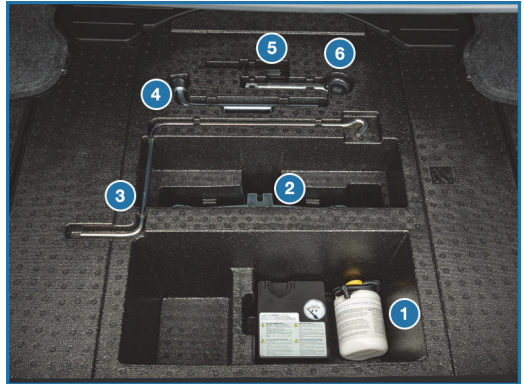

For repair kit instructions and more information, please refer to “In Case of Emergency” in your Owner’s Manual.

ENGINE COMPARTMENT

2.4 L TURBO ENGINE



- 1 Brake Fluid Reservoir/Clutch Fluid Reservoir (MT models)
- 2 Fuse Box
- 3 Battery
- 4 Windshield Washer Tank
- 5 Engine Oil Filler Cap
- 6 Engine Coolant Reservoir
- 7 Radiator Cap
- 8 Engine Oil Filter
- 9 Engine Oil Dipstick
- 10 Air Cleaner Element

1 The following table lists recommended first service items. Your maintenance needs may vary depending on your driving conditions. Please consult with your retailer and refer to the Warranty and Maintenance Booklet for complete information and recommended replacement intervals.

Maintenance Item	Maintenance Interval	
	6 months or 6,000 Miles	12 months or 12,000 Miles
Replace Engine Oil and Filter	•	•
Rotate and Inspect Tires	•	•
Replace HVAC System A/C filter		•
Inspect Clutch Operation (Manual Transmission)		•
Inspect Brake System, Steering System, and Suspension Components		•

ADDITIONAL SPECIFICATIONS

NEW VEHICLE BREAK-IN

The performance and long life of your Subaru are dependent on how you handle and care for your Subaru while it is new.

Follow these instructions during the first 1,000 miles:

- Do not race the engine.
- Do not allow the engine speed to exceed 4,000 rpm except in an emergency.
- Do not drive at one consistent engine or vehicle speed for a long time, either fast or slow.
- Avoid starting suddenly and rapid acceleration, except in an emergency.
- Avoid hard braking, except in an emergency.

ENGINE OIL SPECIFICATIONS & CAPACITIES

- Only use 0W-20 Synthetic Engine Oil.
- 4.8 US quarts (during oil and filter change).

For further details regarding oil specifications & capacities, please refer to “Engine Oil” in the “Specifications” chapter in your Owner’s Manual.

When the level is at the “low” mark, add approximately 1.1 quarts of engine oil in through the filler cap to bring the oil level to the “full” mark. For filler cap location see the engine compartment on page 44.

- 1 Full Level
- 2 Low Level

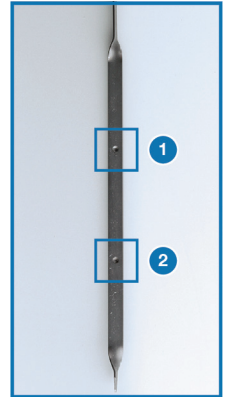

ADDITIONAL SPECIFICATIONS

ROOF MOLDING AND CROSSBAR (if equipped)

Cargo can be carried after securing a roof crossbar kit to the roof molding and installing the appropriate carrying attachment. When installing the roof crossbar kit, follow the manufacturer's instructions and make sure that the total weight of the crossbars, carrying attachment, and cargo does not exceed the maximum load limit. **The maximum total load on the roof (including crossbars, carrying attachments and cargo) must not exceed 88 pounds.**

 For more information, please refer to “Driving Tips” in your Owner’s Manual.

TRAILER TOWING CAPACITY

Your WRX is neither designed nor intended to be used for trailer towing. Therefore, never tow a trailer with your vehicle.

 For more information, please refer to “Driving Tips” in your Owner’s Manual.

TIRE PRESSURE MONITORING SYSTEM (TPMS)

Your Subaru has a Tire Pressure Monitoring System (TPMS) that tracks the pressure of each individual tire. You can learn more by scanning the QR code to see a video with tips and more information about your Subaru’s TPMS.



Scan to learn more about the Tire Pressure Monitoring System.

The TPMS screen shows individual tire pressure in the Combination Meter Display. Use the “i” switch and arrows to display the TPMS screen.

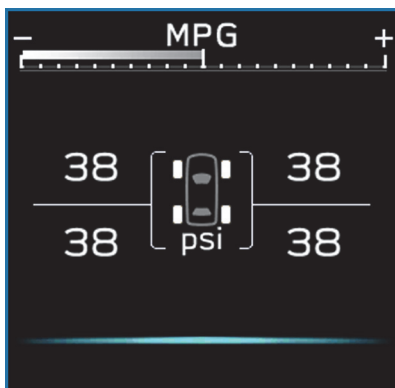

TPMS Screen

ADDITIONAL SPECIFICATIONS

Tire pressure specification is listed on the tire inflation pressure label located on the driver's side door pillar and in the table below. For complete tire pressure specifications and information, please refer to the tire specifications in your Owner's Manual.



Tire Inflation Pressure Label

17-Inch and 18-Inch Wheels

Tire Inflation Pressure	
Front Wheel	Rear Wheel
33 psi	32 psi

19-Inch Wheels

Tire Inflation Pressure	
Front Wheel	Rear Wheel
35 psi	32 psi

STARLINK OVERVIEW

OVERVIEW OF YOUR MULTIMEDIA SYSTEM

SUBARU STARLINK® Multimedia combines the radio along with the ability to connect your phone* through Bluetooth® to the multimedia system for making calls, sending text messages and listening to your favorite songs on your phone.

* Compatible smartphone and application required. For applications to operate, latest version of each application required. Data provided by smartphone is displayed on the Touchscreen. Some state laws prohibit the operation of handheld electronic devices while operating a vehicle. Smartphone apps should only be launched when vehicle is safely parked. Your wireless carrier's rates may apply.

Various Systems

Depending on your model and trim level there are several types of SUBARU STARLINK® Multimedia systems. Some of the functions described in this guide will vary by system.

- Dual 7.0-inch Multimedia
- 11.6-inch Multimedia Plus
- 11.6-inch Multimedia Navigation

Screen Layout

1 Status Bar: The very top of the screen, which shows the outside temperature and clock. Tap on the clock display to adjust the time and other clock settings.

2 Information Bar: Displays the radio station or music track you're listening to, or several other screens of information. If you select the arrows on the right or left, you can scroll through the information programmed to display there, customized through the "Settings" menu.

3 Home Screen: The main part of the display where maps, phone features, Apps and car information is accessed.

4 Home Buttons: Provide shortcuts to frequently used screens:

- Car Settings icon — Allows you to adjust a number of vehicle settings, even while driving.
- Auto Vehicle Hold button — Allows you to activate or deactivate Auto Vehicle Hold.
- Home Button — Returns you to the home screen.
- Manage Devices — Shortcut to the Manage Devices screen.
- Driver Profile Button — Allows you to create or edit driver profiles.



STARLINK OVERVIEW

- 5 Climate Control:** The bottom portion of the screen contains all the settings for climate control, including heated seats. You can adjust the fan speed or airflow mode simply by selecting this area.

BUTTONS

- 1 Volume:** Press the volume control knob to turn on the audio and rotate the knob to adjust the volume. Press the knob again to mute the audio.
- 2 Tune:** Rotate the knob to change the channels. Press and hold to access sound customization settings.
- 3 Car Settings:** Select to display the Car Settings menu.
- 4 Auto Vehicle Hold (AVH):** Press to activate or deactivate Auto Vehicle Hold.
- 5 Home:** Select to return to the Home screen.
- 6 Manage Devices:** Select to go directly to the manage devices screen.
- 7 Driver Profile:** Select to display, set up, or edit driver profiles.



Controlling the Volume

Adjusting the Volume: Turn the “VOLUME” knob to adjust the volume. The volume stays at your set level even after an ignition cycle.





Muting the Volume: Press and release the knob once to turn on or mute the audio.

Turning the System Off: Press and hold the knob for about three seconds and select “OK” when the message appears to turn the system off. The system remains off after an ignition cycle. Press and hold the knob to turn it back on.

STARLINK OVERVIEW

TOUCHSCREEN

Operations are performed by touching the screen directly with your finger.

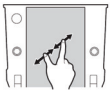
MOTION	ACTION	USE
	Touch Quickly touch and release once.	Changing and selecting various settings
	Double Touch with one finger* Quickly touch and release twice with one finger.	Enlarging the scale of the map screen
	Drag** Touch and drag your finger on the screen to move the screen to the desired position.	<ul style="list-style-type: none">• Scrolling lists• Scrolling the map screen*
	Drag with two fingers* Touch the screen with two fingers and move the displayed screen as desired.	Changing the displayed angle of the 3D map
	Swipe** Quickly move the screen by swiping with your finger.	<ul style="list-style-type: none">• Scrolling lists• Scrolling the map screen*
	Pinch* Move your two fingers further apart (pinch-out) to zoom in on the map. Move your two fingers closer together (pinch-in) to zoom out on the map.	Changing the scale of the map screen

* 11.6-inch with Navi system only

** The operations may not be performed on all screens.

STEERING WHEEL CONTROLS

- 1 Presets/Skip:** Press to toggle through your presets or change a track or media file. Press and hold to scan radio stations or fast-forward/rewind.
- 2 Volume:** Press the volume switch up or down to increase or decrease the volume.
- 3 Source:** Press the source button to change the audio sources between radio modes and media modes.
- 4 Voice Recognition:** Press to activate the built-in voice recognition function. Press and hold to activate the Apple CarPlay®/ Android Auto™ voice recognition function.
- 5 Call/End:** Press to receive or end a call without taking your hands off of the steering wheel.



Starlink® Audio Controls

VOICE RECOGNITION

With SUBARU STARLINK®, simple voice commands can control features like navigation, entertainment, phone calls, and, on select models, climate control. A microphone is located in the overhead console. You do not need to speak directly into it to activate the voice command features. Press the voice recognition switch to start the voice recognition system. Press and hold the switch to cancel it.

For help with what you can say with voice recognition, press the “Help” button on the screen or press the voice recognition button and say “Help”.

Tips

The system may not recognize the voice command due to various types of interference. The following are some causes for voice command interference:

- The command is spoken too quickly or at a low or high volume.
- The command is incorrect or unclear.
- The window is open, the climate control system is set on high, or the ventilation is directed toward the microphone.
- Passengers are talking while the command is spoken.

NOTE: The system is designed to recognize a variety of commands, but certain words, accents or speech patterns may be difficult for the system to recognize.



Scan to learn more
about **Subaru
Multimedia.**

STARLINK OVERVIEW

Common Commands

Below is a list of some of the common commands that you can use with the voice recognition system. Please refer to “Voice Recognition System” in your STARLINK[®] Owner’s Manual for a complete list.

VOICE COMMAND	FUNCTION	EXAMPLE
Dial [Number]	Places a call to the phone number	Dial 555-123-4567
Call [Name] [Phone Type]	Places a call to the contact name and phone type of the contact from the phonebook	Call John Doe mobile
Navigate to [House Number, Street, City, State] ¹	Sets a destination to the address	Navigate to 1234 Main Street, Lincoln, Washington
Show Map ¹	Displays the map screen	Show Map
Find [POI] ¹	Searches map for Point of Interest Category	Find coffee shop
Tune to [Frequency] (AM / FM)	Switches to AM/FM and tunes to spoken frequency	Tune to 99.5 FM
Preset [Number]	Switches to the preset channel	Preset 3
Satellite Channel [Name / Channel Number]	Switches to satellite channel number	Satellite Channel Prime Country 58
Set Fan Speed to [1-7]	Sets the fan speed to the spoken fan speed	Set fan speed to 4
Warmer ² .	Turns up the temperature	Warmer
Set Temperature to [Number] ² .	Sets the temperature to the spoken temperature	Set temperature to 70
Help	Changes to help screen	Help
Phone Help	Displays a list of voice commands related to controlling your phone	Phone Help
Music Help	Displays a list of commands related to media/radio	Music Help
Apps Help	Displays a list of commands related to applications	Apps Help
Navigation Help ¹	Displays a list of voice commands related to navigation	Navigation Help

¹ 11.6-inch Multimedia Navigation system only

HOME SCREEN ICONS

MySubaru – Whether you're on the road or planning adventures, the MySubaru app makes loving every part of owning your Subaru easy.

Apps – Entertainment and convenience applications to enhance your driving experience. The apps included are: MySubaru, Travel Link®, Android Auto™, and Apple CarPlay®.

Radio – Select a station to listen to as well as pause and playback live radio.

Car Info – Displays vehicle status in the “Driving Statistics” screen. Vehicle maintenance intervals are displayed in the “Maintenance” screen.

Map – Enter a destination and have route guidance to get you where you are going.

Media – Play USB/iPod music or Bluetooth® audio by connecting to the device.

Phone – Place and receive calls and text messages.

Settings – Change the settings to your personal choice for select systems inside the vehicle.

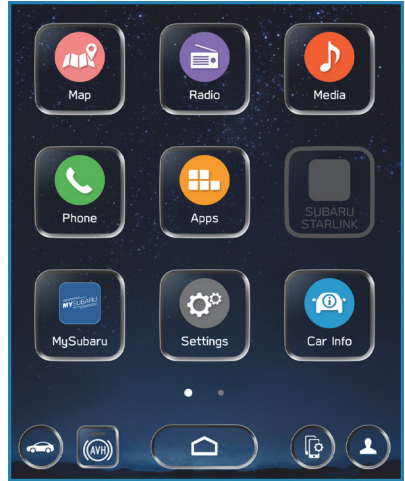

Home Screen Icons



Scan to learn more
about
SUBARU STARLINK®.

STARLINK HOME

REARRANGING ICONS

You can rearrange the home screen icons when in Edit Mode (first make sure "Home Screen Shortcuts" is enabled in "Settings").

To rearrange icons:

- 1 Select and hold the shortcut icon you want to move until "Edit Mode" is activated.
- 2 Drag the icon to the desired position and release.
- 3 To delete an icon, drag the icon to the area at the bottom of the screen labeled "DRAG HERE TO DELETE" and release.
- 4 To exit "Edit Mode" select the "Home" button.

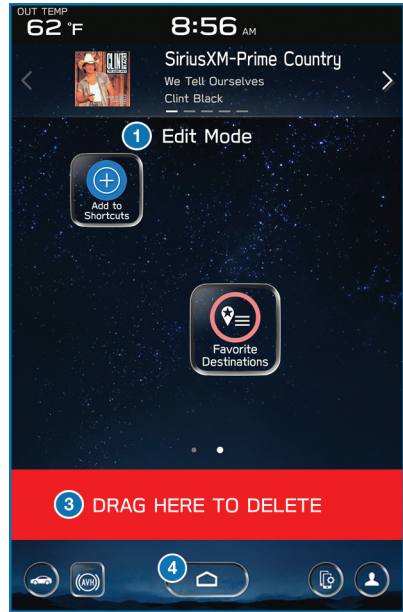

ADDING SHORTCUTS

You can add shortcut icons for various functions to the Home screen when the Home Screen Shortcut function is turned on. To turn on the Home Screen Shortcut function, go to “Settings”, and then the “General” menu.

To add icons, press the “Home” button.

- 1 Select “Add Shortcut”.

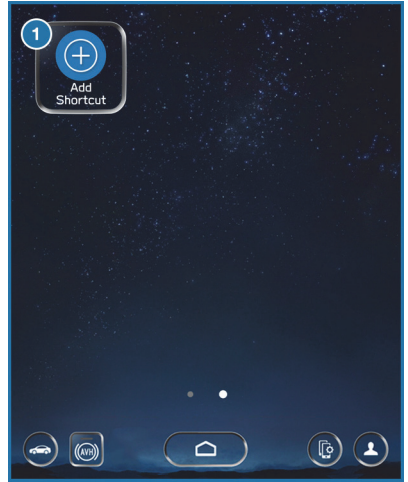

- 2 Select the desired function.

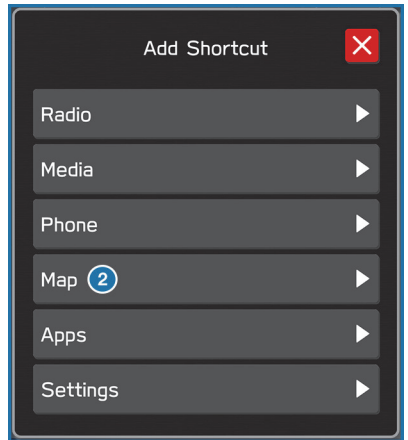

STARLINK HOME

- 3 Select the desired shortcut function.

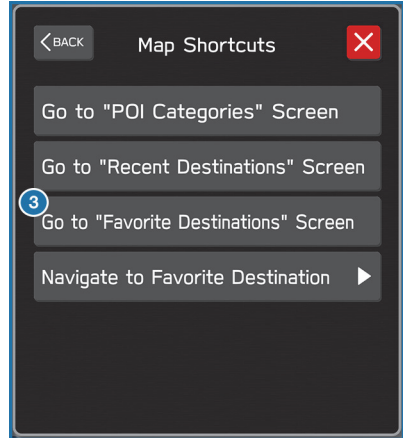

- 4 Check that the shortcut icon is displayed on the Home screen.

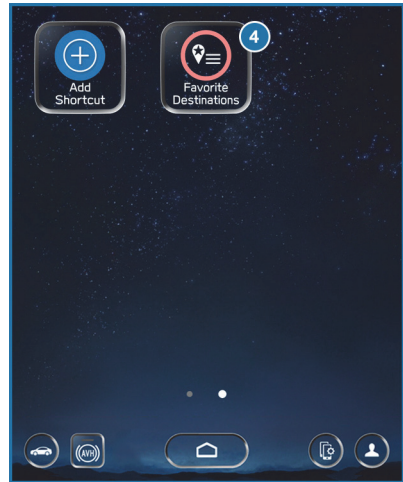

CREATING A DRIVER PROFILE

Creating a Driver Profile provides many benefits beyond just pairing a phone. The profile records and remembers station presets, sound preferences, phone favorites, screen icons and placement.

To create a driver profile:

- 1 On the Home screen, select the Driver Profile button.
- 2 Select "Add".

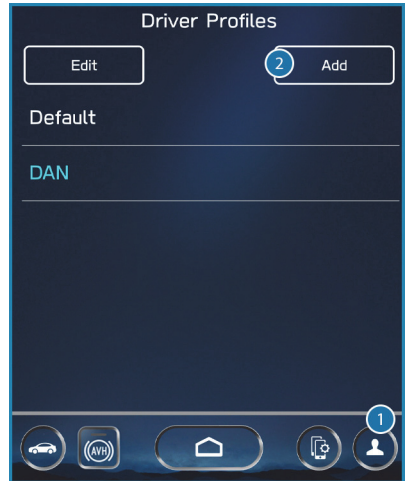

- 3 Select a language and then select "Next".



DRIVER PROFILE

- 4 Select "Driver's Name".

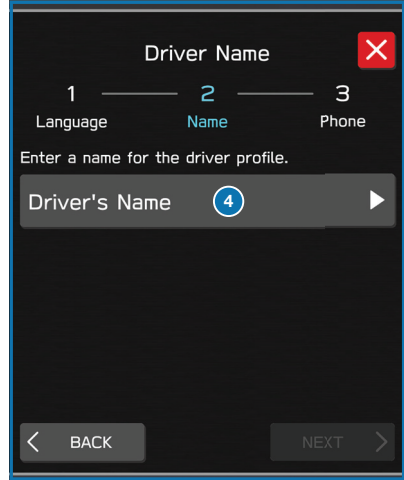

- 5 Type your name in using the keyboard screen, select "Next", and then select "Next" on the following screen to go to phone pairing.

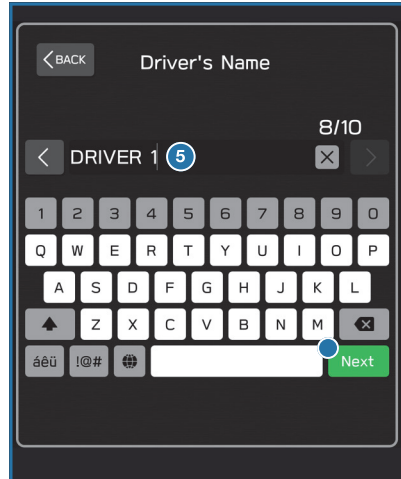

DRIVER PROFILE

- 6 Select "Add Phone" to pair your phone to the system (see page 72 and 78 in this Getting Started Guide) or select your phone if it is already paired.
- 7 Select "Finish".

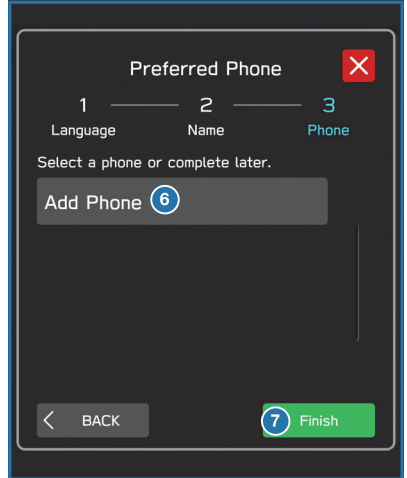

To edit a driver profile:

- 1 On the Home screen, select the Driver Profile button.
- 2 Select "Edit", then select a profile. You can then edit the profile according to same steps as creating a profile.



DRIVER PROFILE

Retrieving a Driver Profile

There are two ways to retrieve a driver profile. The system may automatically retrieve the profile once you are in your Subaru with the multimedia system on and your phone's Bluetooth® active. You can also manually retrieve or change the profile by following these steps:

1. Press the "Driver Profile" button.
2. Select the profile you want. You will receive a pop up screen asking "Are you sure you want to activate this profile?"
3. Select "OK".

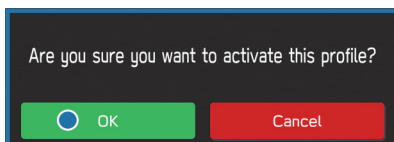

VALET MODE

The valet mode function prevents others from operating the navigation, audio, and vehicle settings in your Subaru, offering an increased level of security and peace of mind when using valet parking services. The passcode for valet mode can be set or changed in Settings in the General menu or through the MySubaru app, if subscribed.

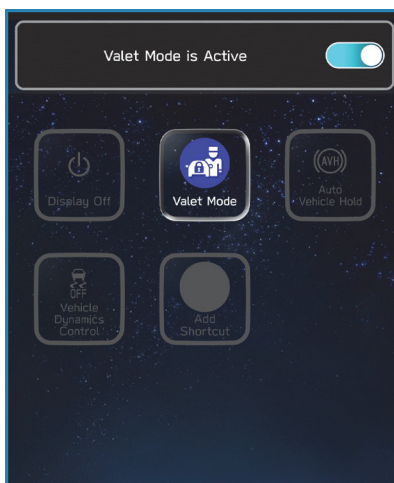

Activating Valet Mode

Once you have set the passcode, valet mode can be quickly and easily activated on the home screen:

- 1 Select the “Valet Mode” button on the home screen.

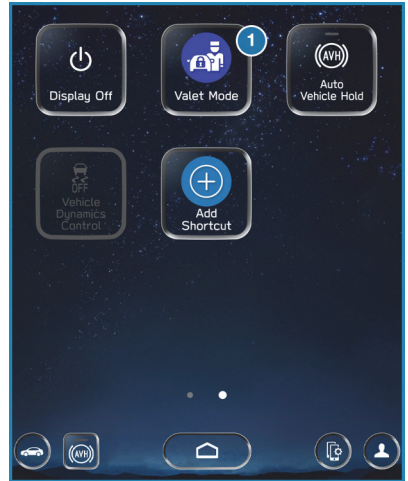

- 2 Enter your passcode using the keypad.

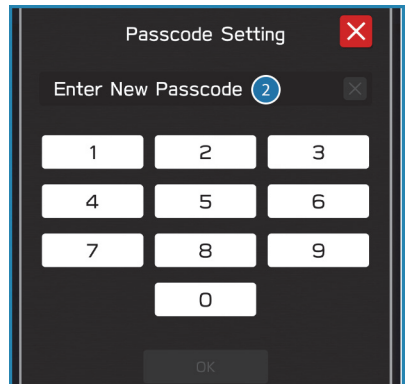

DRIVER PROFILE

- 3 Select "OK".

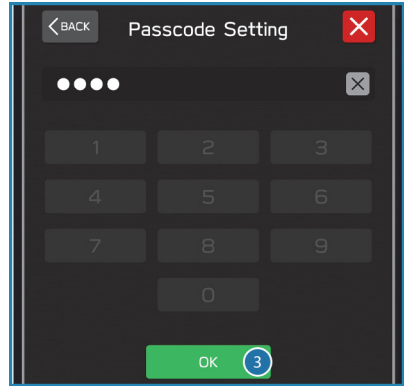

- 4 Valet mode is activated, securing your navigation, audio, and vehicle settings.

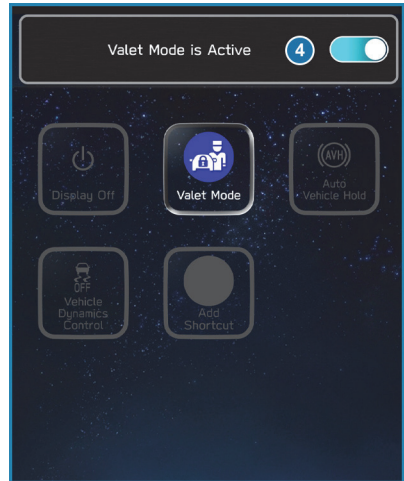

Deactivating Valet Mode

Complete the following steps to deactivate valet mode and restore your personal settings:

- 1 Select the “Valet Mode” button on the home screen.
- 2 Enter your passcode using the keypad.

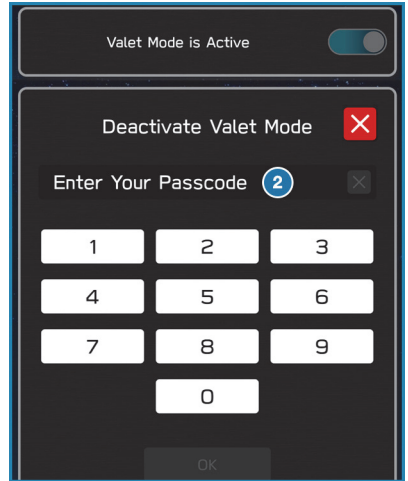

- 3 Select “OK” to deactivate valet mode.
- 4 Select “OK” to initiate a facial scan from the Driver Monitoring system and restore your personal settings.

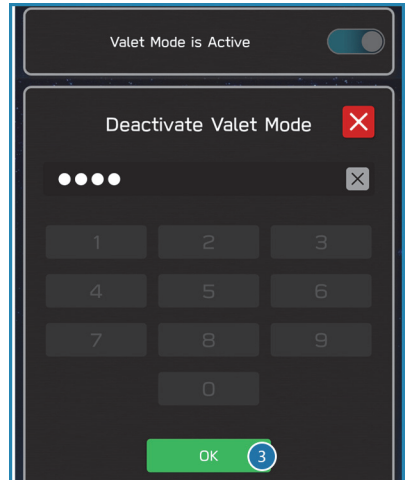

MULTIMEDIA

RADIO

AM/FM Radio

Your Subaru is equipped standard with AM/FM radio, which includes HD Radio®. HD Radio® technology is the digital evolution of analog AM/FM radio. Your radio has a special receiver which allows it to receive digital broadcasts (where available) in addition to the analog broadcasts it already receives. Digital broadcasts have better sound quality than analog broadcasts, as digital broadcasts provide free, crystal clear audio with no static or distortion.

 Visit www.hdradio.com for more information and a guide to available radio stations and programming.



Scan to learn more about HD Radio.

Satellite Radio

A SiriusXM® Satellite Radio is a tuner designed exclusively to receive broadcasts provided under a separate subscription. After a free trial period, a subscription is necessary to continue service.

SiriusXM® with 360L

SiriusXM® with 360L provides an even more personalized radio experience than basic SiriusXM® by offering additional features like:

- 1 **Profiles:** Set up as many as five different listener profiles.
- 2 **Notify Me:** Get notified when your favorite artist, song, or team is playing.
- 3 **Related:** Suggested content related to what you are currently listening to.
- 4 **For You:** Personalized channel recommendations based on your listening habits. The more you listen, the more accurate your recommendations will be.
- 5 **Categories:** Select between Music, Sports, News, and Talk.
- 6 **Search:** Hands-free channel searching using your voice.
- 7 **Favorites:** Save your favorite channels so you can direct tune for quick selection.

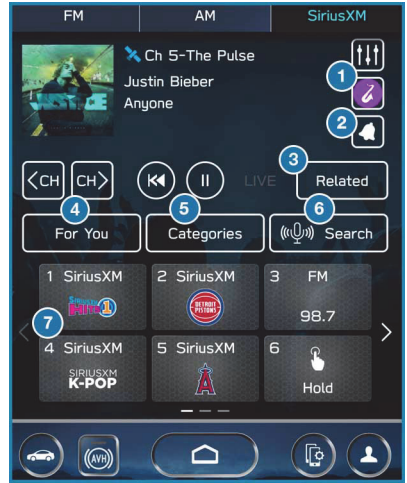

Scan to learn more about
SiriusXM Radio.

MULTIMEDIA

To Add or Change Listener Profiles

- 1 Click on the profile icon on the SiriusXM® home page, then select the current listener profile.

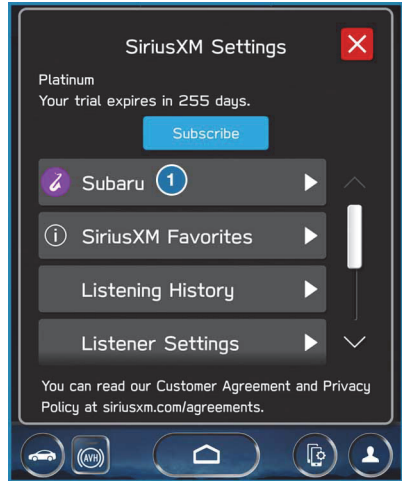

- 2 Click on the profile you wish to use, or select Add to create a new profile. You can save up to five different profiles to your vehicle.

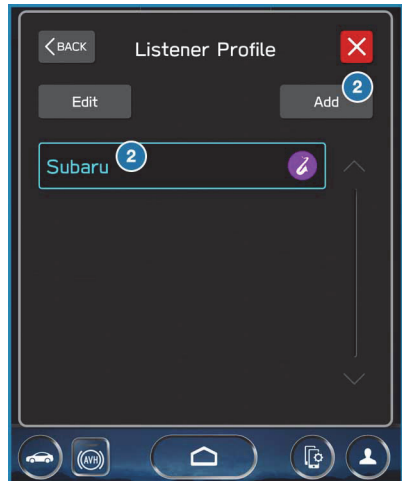

Setting Up Notifications

- 1 To get notified whenever an artist, song, or team is playing, click on the notification icon on the SiriusXM® home page.
- 2 A window will pop up asking if you would like to set the notification for the current artist or song that is playing. Select your preferred option, and then select Done.

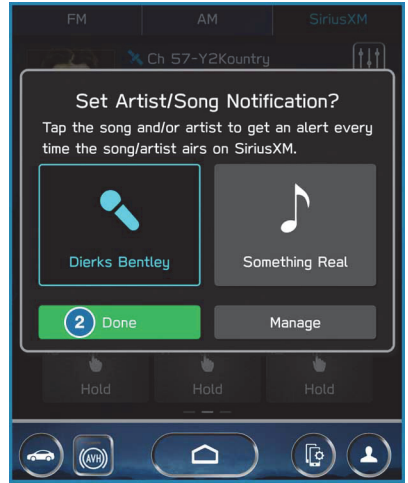

SiriusXM® Categories

The Categories button allows you to easily find channels:

- **Music** – Select your preferred category and a list of related channels will appear for quick tuning.

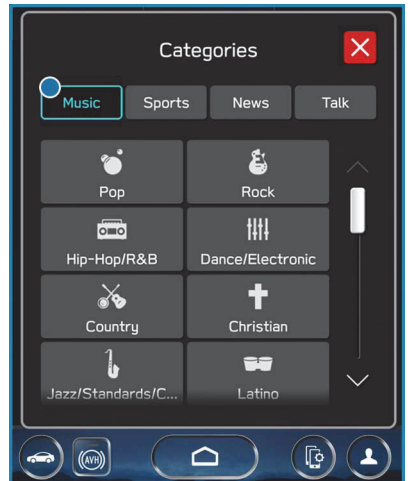

MULTIMEDIA

- **Sports** – Select live sports and choose the game you would like to listen to live, or select a category and then a team for game highlights and play-by-play.

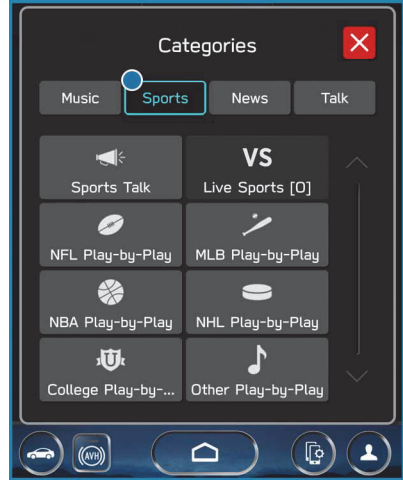

- **News** – Select between News/Public Radio and Politics/Issues, then select the channel you want to tune to.

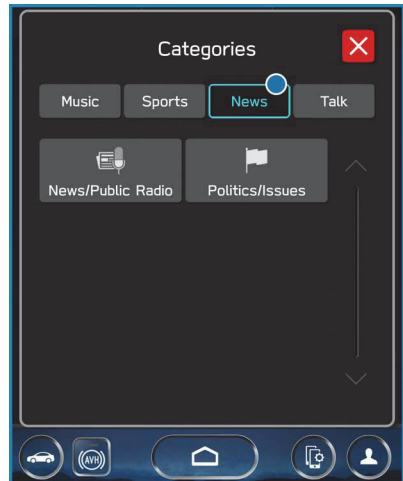

- **Talk** – Select between a variety of talk radio categories and then choose the channel you want to tune to.

 For more information or to subscribe, visit www.siriusxm.com.

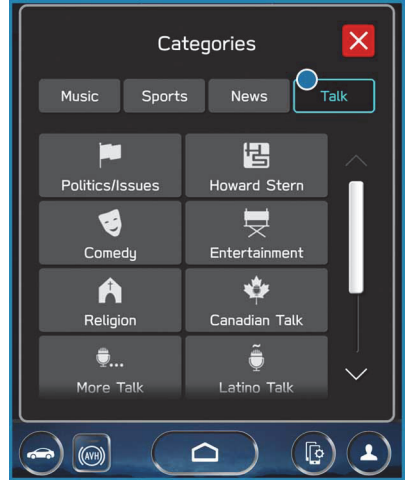

Presets

You can preset 18 stations. Presets can be set for SiriusXM®, FM, or AM stations, allowing you to switch among the three with the press of a single button. To preset a radio station:

1. Tune to the desired channel.
2. Press and hold one of the desired preset station buttons.



MULTIMEDIA

MEDIA

Bluetooth®

Your Subaru has Bluetooth® hands-free technology to manage your phone and audio systems. Bluetooth®-enabled mobile phones link directly through your Touchscreen automatically, once connected. Receive and initiate calls or play music directly from your device while keeping it stowed for safety.

To pair a Bluetooth® device to the Touchscreen, see page 72 for Android devices or page 78 for Apple devices.

USB / iPod

The USB connection is below the Center Information Display (CID). You can plug in a USB memory storage device or iPod. This will bring up the media screen with controls. If using an iPod, make sure to use an Apple certified cable or MFi certified cable for proper operation.

AUX Input

The AUX jack is a port that allows the input from an audio device such as MP3 players, portable music players and iPods. To access the AUX menu, plug in the device to the AUX jack and the menu will appear, or select the AUX menu from the Touchscreen under “Media”.

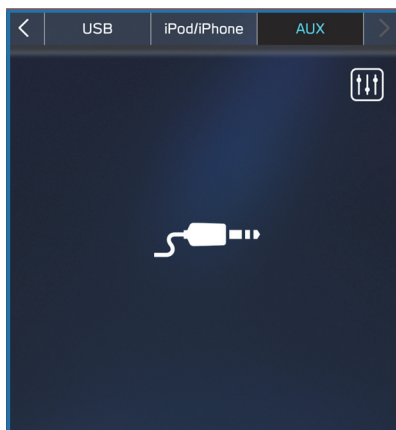

PAIRING A PHONE

Using a Bluetooth® connection with the Touchscreen allows you to use the voice recognition system to make and receive calls. It provides access to your phone book on your phone and can read incoming text messages as well as reply via voice recognition. It remembers your driver profile when your phone pairs via Bluetooth®.

Visit www.subaru.com/engineering/starlink/multimedia.html for more information on what is available by connecting a phone to the STARLINK® Multimedia system.

For instructions on how to pair your phone to the STARLINK® Multimedia system, see page 72 for Android devices or page 78 for Apple devices.



Scan to learn more
about **Subaru
Multimedia.**

PHONE

PAIRING AN ANDROID PHONE

Bluetooth® Pairing and Android Auto

- 1 Select the Manage Devices icon on your vehicle touchscreen display.
- 2 Select Add in the manage devices pop-up. Prompts appear on your vehicle touchscreen as you pair your device. Complete the actions on your phone, and then select the arrow on your vehicle touchscreen to move to the next step.

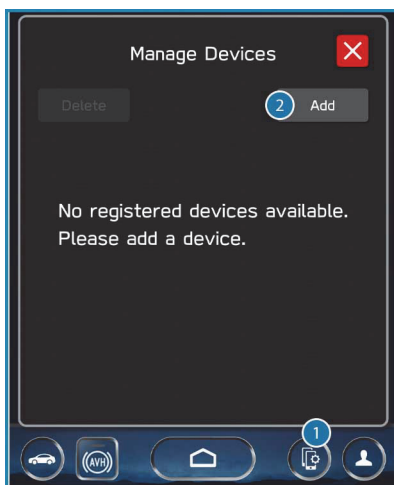

- 3 On your Android device, select "Settings" (it can be found under apps).

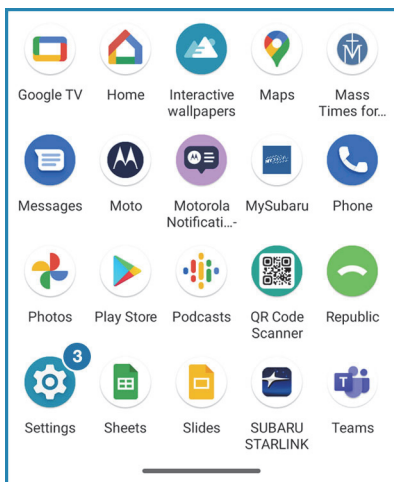

- 4 Next select Connected Devices / Bluetooth.

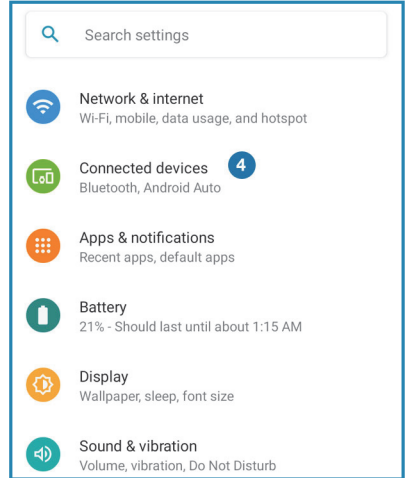

- 5 Select "Pair new device" or a list may already be showing of nearby devices to add.

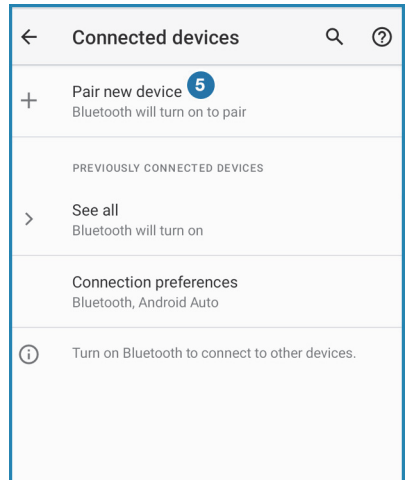

PHONE

- 6 Select your vehicle name from the list of available devices.

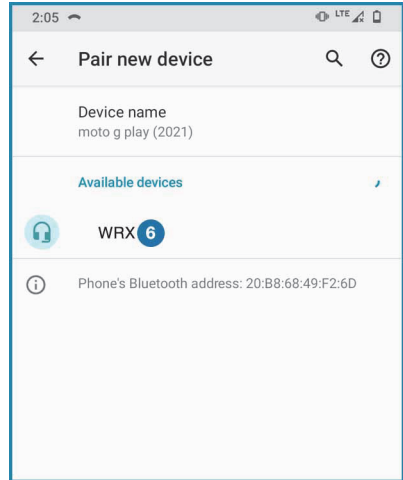

- 7 Confirm the PIN matches the numbers displayed on your vehicle touchscreen display and select "Pair" on your phone.

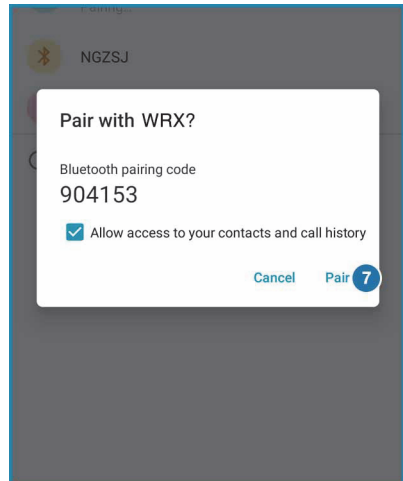

- 8 Select Allow on the “Allow Access to Messages” pop-up box on your Android phone, and select “Yes” if the “Contact Transfer” pop-up appears on your vehicle touchscreen display.

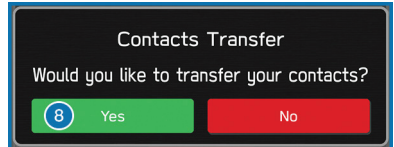
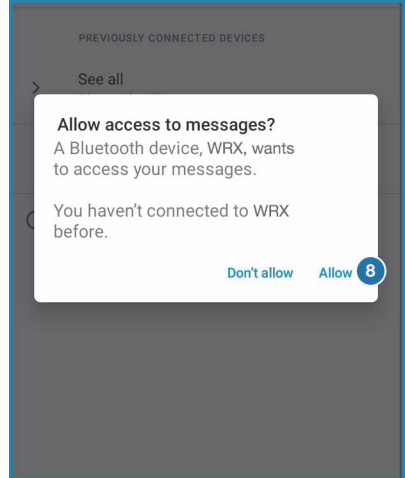

- 9 Select Yes on the “Start Android Auto” pop-up on your vehicle touchscreen display to connect to Android Auto.

NOTE: If you do not wish to activate Android Auto, select No. Only Bluetooth® will be set up. You can still activate Android Auto later by selecting the Manage Devices icon on the home screen.

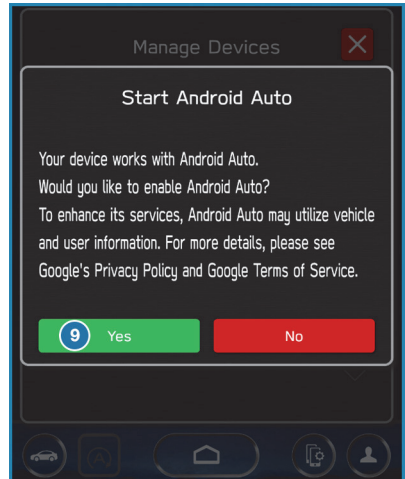

PHONE

- 10** Android Auto should auto launch on your vehicle touchscreen. If not, select the Home button, and then select the Android Auto button on the home screen.

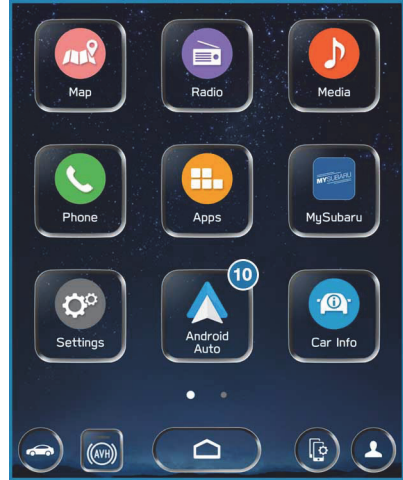

Android Auto Best Practices

To get the best out of your Android Auto experience, make sure of the following:

- Ensure the Android Auto App is installed from the Play Store.
- If connecting with a USB cable for the first time, ensure it's a quality Android approved cable with no adapters or splitters in between your phone and the vehicle USB port.
- Ensure the Android phone operating system is fully up to date.
- Ensure all other apps that work on Android Auto are up to date (for example, Google Maps, Waze, Spotify, and others). Android Auto might not function correctly if one of these apps is outdated or having an issue. Apps can be updated in the "Play Store" app.

If Android Auto won't launch for the first time, follow these steps:

1. On your Android Phone, go to Settings, select Apps, and then select Android Auto.
2. Select Storage.
3. Select Clear Storage and Clear Cache.
4. Select the Manage Devices icon on your vehicle touch screen display.
5. Select Delete, and then select the Android phone to delete it from the system.
6. Start the Connection process again or try connecting via USB cable to initiate the wireless Android Auto connection.
7. If issues persist, uninstall the Android Auto app from your phone and reinstall the app from the Play Store.

- i** Visit the Android Auto website for the latest info, FAQs and device compatibility:
<https://www.android.com/auto/>.

Android Auto Compatible Models and Cables

Android Auto™ is available on Android phones. To see if your phone is compatible, please refer to the Android Auto™ website:
<https://www.android.com/phones/>

When using a cable to connect to Android Auto™, always use a high-quality OEM USB cable. Ensure the Android phone is fully up to date. Also, verify that the Android Auto™ app, along with all other apps that work with Android Auto™, are up to date. Android Auto™ might not function properly if one of them is outdated or having an issue. The apps can be downloaded on Google Play.

 For more information, visit <https://www.android.com/auto/>



Scan to see if
your phone is
compatible with
Android Auto



Scan to learn
more about
Android Auto

PHONE

PAIRING AN IPHONE

Bluetooth® Pairing and Apple CarPlay

- 1 Select the Manage Devices icon on your vehicle touch screen display.
- 2 Select Add in the manage devices pop-up. Prompts appear on your vehicle touch screen as you pair your device. Complete the actions on your phone, and then select the arrow on your vehicle touchscreen to move to the next step.

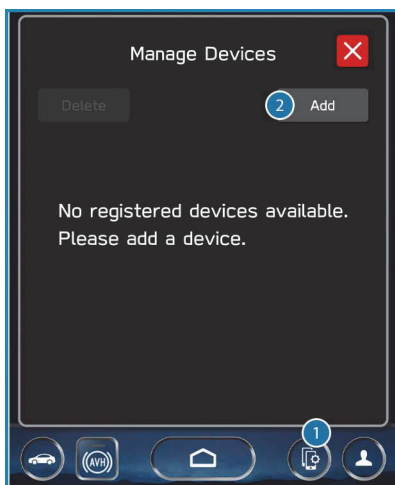

- 3 On your iPhone, select Settings.

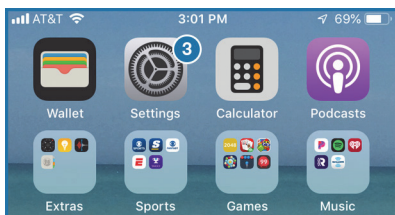

- 4 Select "Bluetooth" on your iPhone.

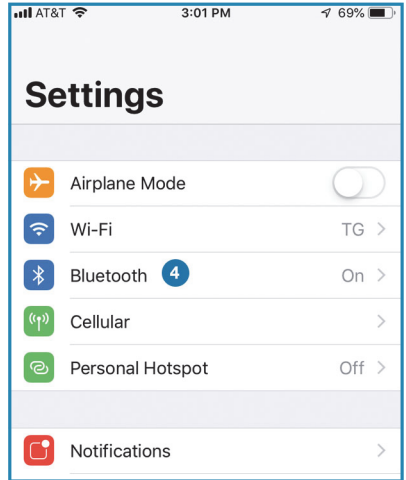

- 5 Select your vehicle from the device list.

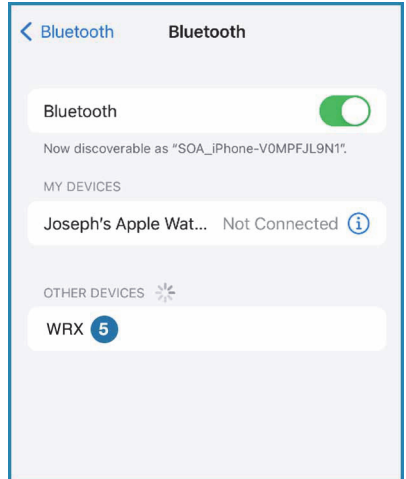

PHONE

- 6 Verify your iOS/Apple device PIN is correct and select "Pair".

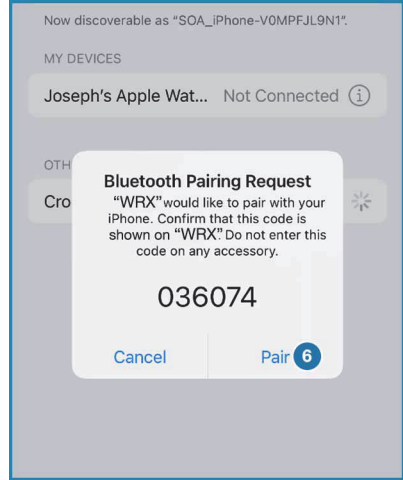

- 7 Select Allow for contacts and favorites to sync from your iPhone and select "Yes" if the "Contact Transfer" pop-up appears on your vehicle touch screen display.

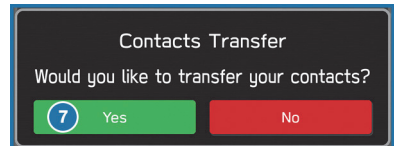
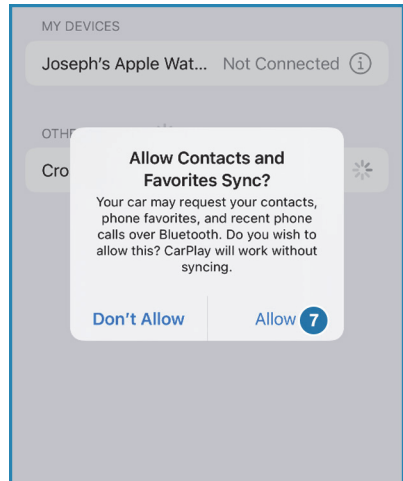

- 8 Select Use CarPlay on your iPhone.

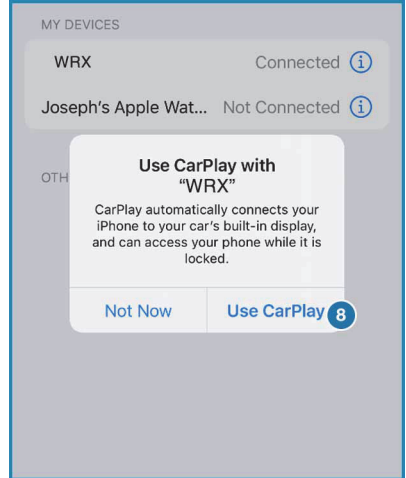

- 9 Select Yes on the "Apple CarPlay" pop-up on your vehicle touch screen display.

NOTE: If you do not wish to activate Apple CarPlay, select No. Only Bluetooth® will be set up. You can still activate CarPlay later by selecting the Manage Devices icon on the home screen. Be sure to wait for this prompt to appear on your vehicle touchscreen before changing gear positions.



PHONE

- 10 Select Yes on the Device Registration pop-up to set your iPhone to be the favorite device that will connect first when your vehicle is started.

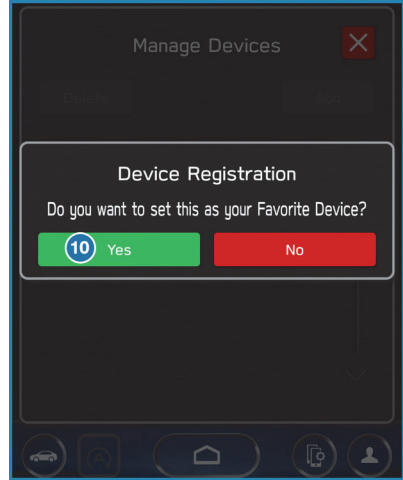

- 11 CarPlay will appear on the vehicle touchscreen. If not, select the Home button, and then select the Apple CarPlay button.

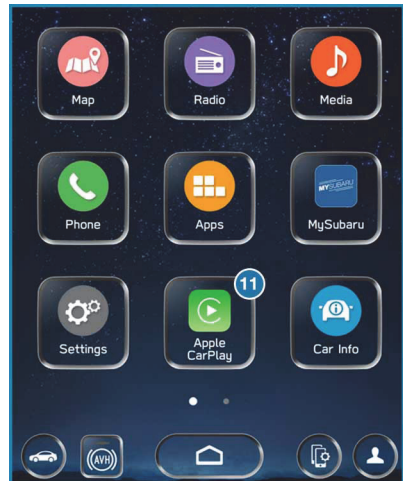

Apple CarPlay Best Practices

To get the best out of your Apple CarPlay experience, make sure of the following:

- Ensure your iPhone is fully up to date.
- Ensure all other apps that work on Apple CarPlay are up to date (for example, Pandora, Apple Maps, Spotify, and others). Apple CarPlay might not function correctly if one of these apps is outdated or having an issue. Apps can be updated in the App Store app.

If CarPlay does not launch the first time, complete the following steps:

1. Confirm CarPlay is enabled on your iPhone by selecting Settings, then Screen Time, and then Content and Privacy Restrictions.
2. If “Content and Privacy Restrictions” are enabled, the slider will be green, which means apps like CarPlay may be disabled.
3. If so, select Allowed Apps, and ensure CarPlay is enabled (the slider is green).

If CarPlay does not launch after the above steps, try the following:

1. Go to the Settings on your iPhone and select Bluetooth®.
2. Select the blue “i” next to your vehicle.
3. Select Forget This Device.
4. Return to Settings, and now select General.
5. Select CarPlay.
6. If your vehicle is shown, select it, and then select Forget This Car.
7. On your vehicle touch screen display, select the Manage Devices icon.
8. Select Delete, and then select your iPhone to delete it from the system.
9. Start the pairing process over, or plug your iPhone into the USB port to try the process via USB connection.

iPhone Compatible Models and Cables

If using a cable to connect for Apple Carplay, the cable must be an 8-Pin Lightning MFi Certified cable (made for iPod/iPhone). Look for the “Works with Apple CarPlay®” or “Made for iPod, iPhone, iPad” icons when selecting a cable.

 For a list of all the Apple phones that are compatible with Apple CarPlay® and more information, please visit www.apple.com/ios/carplay/



Scan to learn
more about
Apple CarPlay

PHONE

MAKING A CALL

With a paired phone, you can make a call through voice recognition by touching the “Voice Recognition Switch” on the steering wheel to start the voice recognition system. After pressing the “Voice Recognition Switch”, wait for the “Voice Guidance” screen to appear on the Touchscreen and say “Call [name and phone type]” or “Dial [number]”.

To make a call from the Touchscreen, start by pushing the “Home” button and then select “Phone”. After the phone screen displays, select the method you would like to use to make a call.

- Recents – Allows you to call someone that has recently called you or that you called.
- Favorites – Allows you to place a call to one of your registered favorites.
- Phonebook – Will display the phonebook that is on your phone.
- Messages – Allows you to call someone that recently sent you a text message.
- Keypad – Allow you to dial any number you would like.

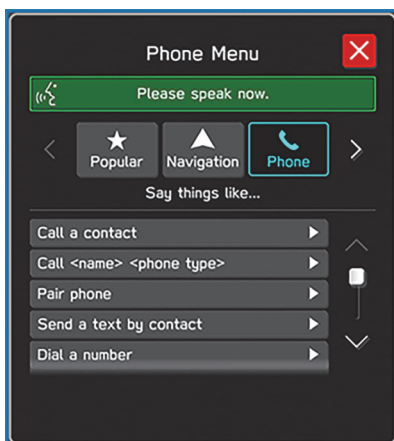

RECEIVING A CALL

To receive a call, press the “Call” switch on the steering wheel or the “Accept” button on the Touchscreen.

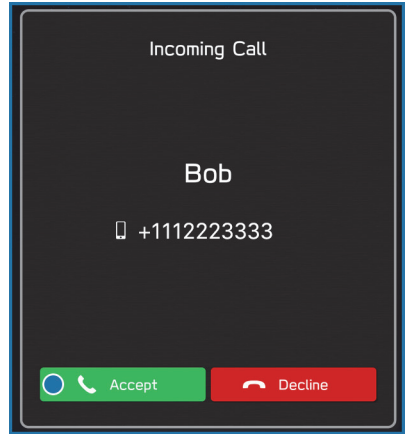

To reject a call, press the “End” switch on the steering wheel or the “Decline” button on the Touchscreen.

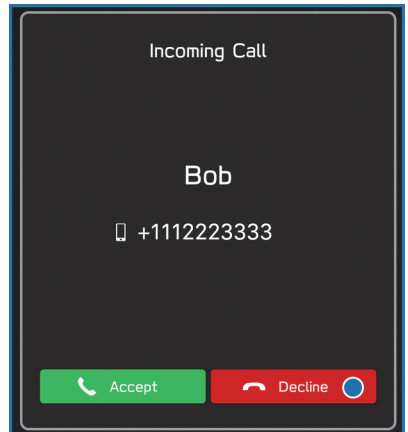

PHONE

TEXT MESSAGES

Received messages can be forwarded from the connected Bluetooth® phone, enabling checking and replying using the system. To use this function, it is necessary to set the phonebook download function to ON.

When a Short Message Service (SMS)/ Multimedia Messaging Service (MMS) is received, the incoming message screen pops up with sound and is ready to be retrieved using the Touchscreen. Select “Play” to listen to the message. After listening to the message, you can also select the “Reply” button to reply to the sender using a generated message.

If there is more than one unread message, a screen will appear to allow you to either view your inbox or ignore the message.

Depending on the Bluetooth® phone type, the screen display may differ, messages may not be transferred to the message inbox, or it may not be possible to use certain functions.

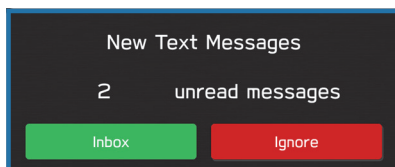
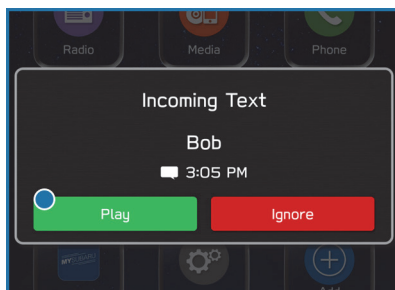

SUBARU STARLINK® IN-VEHICLE APPS

SUBARU STARLINK® Multimedia offers advanced connectivity through Apple CarPlay® or Android Auto™ apps. Wireless pairing and hands-free smartphone operation allow for safe and easy connection to your favorite apps and content.

For a complete list of all the apps available, visit www.subaru.com/engineering/starlink/multimedia.html



Scan to learn more about **Subaru Multimedia**.

Android Auto™

Android Auto™ can be used to view maps, play music, and place calls by connecting your Android device to the system. You can also run supported applications.

 For more information, please refer to page 72.

For details on the services or the operations, visit the Android Auto sites www.android.com/auto/ or www.support.google.com/androidauto/



Scan to learn more about **Android Auto**



Scan to learn more about **Android Auto Help**

To use Android Auto™ on your car display, you'll need an Android phone running Android 6 or higher, an active data plan, and the Android Auto™ app.

Apple CarPlay®

Apple CarPlay® can be used to view maps, play music, and place calls by connecting your iPhone to the system. You can also run supported applications.

 For more information, please refer to page 78.

For details on the services or the operations, check the Apple CarPlay® site: www.apple.com/ios/carplay/



Scan to learn more about **Apple CarPlay**

APPS

SiriusXM® Travel Link

SiriusXM® U.S. satellite and data services are available in the 48 states of the contiguous USA and DC.

Data service information, comprising fuel prices, sports, stocks, weather, weather alerts, and parking, can be received via the SiriusXM® Radio.

To receive the data service information in the vehicle, a subscription to the SiriusXM® Satellite Radio Service is necessary following a free trial.

MYSUBARU

Whether you're on the road or planning adventures, the MySubaru app makes loving every part of owning your Subaru easy. Although the mobile app is great when you are on the go, you can also visit www.MySubaru.com from your computer to access similar functions and to aid in planning your trip before you leave.

You can download the MySubaru app on Google Play or the Apple App Store on your phone by searching MySubaru.

By creating an account, you can:

- Schedule service with a Preferred Subaru Retailer
- Get vehicle service reminders, recall alerts, and exclusive coupons
- Track and record your service history
- Access resources like your owner's manuals, how to videos and more
- Have access to SUBARU STARLINK® Safety and Security features (must have an active SUBARU STARLINK® subscription)
- Get help from enhanced roadside assistance (requires active SUBARU STARLINK® subscription)



Scan to get the
MySubaru App.

Service Appointment Scheduler

The SUBARU STARLINK® Service Appointment Scheduler can help you set an appointment from the MySubaru website, Mobile App or the vehicle's Touchscreen. Getting your Subaru vehicle to the Subaru professionals for service is easy, no matter where you are. If you are away from your preferred Subaru Retailer for service, you can always use Service Appointment Scheduler to locate any of our certified Subaru Retailers near your location.

SUBARU STARLINK® Service Appointment Scheduler on your Touchscreen is a convenient way to set a service appointment. Simply select the MySubaru icon on the Home screen and choose "Make an Appointment" to get started.

An active SUBARU STARLINK® subscription is required to use this in-vehicle feature.

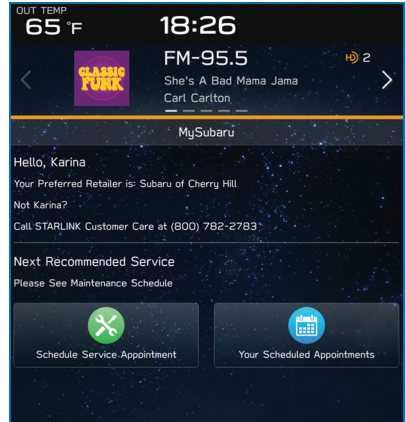

MAPS (if equipped)

MAPS OVERVIEW

Your new SUBARU STARLINK® comes equipped with an integrated navigation system, powered by TomTom®. We hope you enjoy the state-of-the-art navigation technology and optimized mapping routes to guide you on safer, better, and more enjoyable journeys.

With your integrated navigation system, you can find destinations by address or search by points of interest, as well as save destinations in the system as favorites. You can also customize route options and settings and find the nearest gas station along your route with the touch of a button.

 For more information and step by step directions on using your navigation system, please refer to page 126 in this Getting Started Guide or “Navigation System (If equipped)” in your STARLINK® Owner’s Manual.

What3words

What3words is an innovative addressing system that divides the world into 3 meter (about 10 ft.) squares and assigns each square a unique combination of three words. This functionality is seamlessly integrated into your navigation system, making your everyday adventures easier than ever. For example, What3words enables you to conveniently find and share locations as specific as building entrances and parking spots with your friends, and provides easy location references in places with no street addresses, such as beaches, national parks, and remote hiking trails.

 For more information and step by step directions on using What3words with your navigation system, please refer to page 131 in this Getting Started Guide or “Navigation System (If equipped)” in your STARLINK® Owner’s Manual.





Scan to learn more
about the features
of your
navigation system.

STARLINK SAFETY AND SECURITY

SAFETY AND SECURITY OVERVIEW (if equipped)



STARLINK® Safety and Security services* are designed to help in your time of need. These include Advanced Automatic Collision Notification, SOS Emergency Assistance, Enhanced Roadside Assistance, Stolen Vehicle Recovery, the added convenience of Remote Engine Start with Climate Control, and so much more.

With the SUBARU STARLINK® system integrated into your vehicle, advanced safety and security technology is just a button press away. The SUBARU STARLINK® experience includes in-vehicle call center support, maintenance and diagnostic alerts as well as remote services that keep you connected to your Subaru vehicle.

Located in the overhead console of most Subaru vehicles are the red SOS  and blue i-button . Both buttons link you to the SUBARU STARLINK® call centers that are there to support you 24 hours a day, 7 days a week.

The SOS button  is for SOS Emergency Assistance.

The i-button  is for Enhanced Roadside Assistance or Concierge (if subscribed).

- Press the SOS button  for SOS Emergency Assistance.*
- Press the i-button  for Enhanced Roadside Assistance* or Concierge* (if subscribed).*

- To cancel a SOS Emergency Assistance, Enhanced Roadside Assistance or a Concierge call, press and hold the same button for approximately two seconds or select the “End Call” button if displayed on the Touchscreen.

Head to www.Subaru.com/STARLINK to see all the SUBARU STARLINK® subscription services and packages.

* Access to STARLINK® Safety and Security services requires an active STARLINK® subscription. Not available in all States. See Retailer for details. Remote Engine Start available on keyless access with push-button start vehicles. Remote Engine Start with Climate Control is available on select models only. Not available on vehicles with manual transmission. See Retailer for details or visit the STARLINK® page on Subaru.com to learn more.



Scan to learn more about SUBARU STARLINK.

STARLINK SAFETY AND SECURITY

ENROLLMENT

To enroll in SUBARU STARLINK[®] and access remote services, a MySubaru account is required. MySubaru is the Subaru owner website that allows you to access vehicle remote services, user preferences, diagnostic alerts and other useful features enabled by your STARLINK[®] Safety Plus, STARLINK[®] Security Plus and STARLINK[®] Concierge subscription.

Your Retailer may have created an account for you during the delivery process. However, you can also create a MySubaru account at www.mysubaru.com.

Enrollment in SUBARU STARLINK[®] can be done online at MySubaru.com, through the MySubaru Mobile App, at your Subaru Retailer or by calling a STARLINK[®] Customer Care Representative at: 1-855-753-2495

NOTE: Please have your Vehicle Identification Number (VIN) available, as you will need it to complete this step. After the enrollment process, you will learn more about the features in detail at MySubaru.com.

MYSUBARU INTEGRATION

The connection between you and your Subaru has never been simpler, and the MySubaru website (MySubaru.com) and MySubaru Mobile Application are the best ways to stay in touch with your Subaru vehicle. From MySubaru, you can access the following information and STARLINK[®] Safety and Security services*:

- Remote Services
- Vehicle Health
- Usage Reports
- Service Appointment Scheduler
- Vehicle Maintenance Schedules
- Destination to Vehicle
- Service History
- Support Resources

* Activation with subscription required. Features and availability vary by vehicle and trim level. See your Retailer for details.

STARLINK SAFETY AND SECURITY

SUBARU STARLINK® WI-FI HOTSPOT (if equipped)

SUBARU STARLINK® in-vehicle Wi-Fi Hotspot* keeps you and your family connected using AT&T's 4G LTE nationwide cellular network. Whether watching movies, playing games or even listening to music, your family won't miss a beat with SUBARU STARLINK® in-vehicle Wi-Fi Hotspot. Set up is quick and easy.

 For more information on a subscription and step by step enrollment instructions, please refer to page 125 in this Getting Started Guide or visit:

<https://myvehicle.att.com/#/subaru/learn?country=US&language=en>

* Internet access is purchased separately through AT&T with monthly, per gigabyte, and unlimited data options available. Existing AT&T customers have the option to add an additional line to their AT&T Mobile Share plan. Available on select models.



Scan to learn
more about **AT&T**
Wi-Fi Hotspot

SETTINGS AND UPDATES

SETTINGS AND UPDATES OVERVIEW

Many settings can be customized for different features in your Subaru. In this section you will find examples and instructions for some of the settings you can tailor to fit your preferences, as well as ways to keep your system updated.

Connect to Home Wi-Fi (Navigation Models Only)

Connecting to your Wi-Fi network can allow you to update the maps. Wi-Fi can be found from the Home Screen by selecting “Settings”. To access Wi-Fi settings and available networks:

- 1 In the “General” menu, select “Wi-Fi Settings”.
- 1 For step by step instructions on connecting to Wi-Fi, please refer to page 123 in this Getting Started Guide or “Settings” in your STARLINK® Owner’s Manual.



Performing Software Updates

Software updates provide enhancements to the system, such as new features, added security, and upgraded functions. If you experience any issues or have questions related to updating your STARLINK® software, please contact your preferred Subaru Retailer.

For the 11.6-inch Multimedia Plus and the 11.6-inch Multimedia Navigation systems, system software can be updated via a Data Communication Module (DCM), if equipped. A STARLINK® Safety Plan subscription is also required. You will receive in-vehicle prompts and instructions on how to download and install the software update.

NOTE: System functionality will be restricted during installation, and you may need to reset radio station presets and volume settings after the update process.

- 1 For step-by-step instructions and more information, please refer to page 143 in this Getting Started Guide or “Settings” in your STARLINK® Owner’s Manual.

SETTINGS AND UPDATES

SOUND

To change the sound settings, press the “Home” button and select “Settings”, then “Sound”. Choose the setting you want to change.

SETTING	FUNCTION
Audio	<p>In the audio settings, you may have the following setting capabilities:</p> <ul style="list-style-type: none">• Sound Customization — This function allows you to set the Equalizer, Balance/Fader and Vocal Image Control.<ul style="list-style-type: none">• Equalizer — How good an audio program sounds is largely determined by the mix of the treble, mid and bass levels. In fact, different kinds of music and vocal programs usually sound better with different mixes of treble, mid and bass.• Balance/Fader — A good balance of the left and right stereo channels and of the front and rear sound levels is also important. Keep in mind that when listening to a stereo recording or broadcast, changing the right/left balance will increase the volume of 1 group of sounds while decreasing the volume of another.• AUX Volume Gain — Sets the AUX volume gain.
Navigation Guidance Volume	Sets the navigation prompt volume.
Beep Sound Setting	Turns the tone sound on or off.
Beep Sound Volume	Sets the tone sound volume.
Phone Ringtone Volume	Sets the ringtone volume.
Incoming Call Volume	Sets the volume of the received call.
Call Volume	Sets the call volume.
SMS/MMS Ringtone Volume	Sets the SMS/MMS ringtone volume.
SMS/MMS Read Out Volume	Sets the SMS/MMS read out volume.
Voice Volume	Sets the voice recognition prompts volume.

SETTINGS AND UPDATES

PHONE

This system supports Bluetooth[®], a wireless data system, allowing you to make and receive calls without taking your hands off the steering wheel.

In the settings menu, you will be able to manage devices, adjust phone book and message settings, and adjust other phone/Bluetooth[®] settings.

To access the phone settings screen, press the “Home” button, select “Settings”, then select the “Phone” menu.

MAPS/NAVIGATION

There are many settings that can be customized to your preference. These settings are under the “Setting” menu and then “Navigation”. Below are some of the common settings you may want to customize:

SETTING	FUNCTION
Show Along Route	Turn the display for parking lots, gas stations and rest areas on or off for the route being traveled during route guidance.
Arrival Distance/Time	Sets the display for the estimated remaining distance and estimated remaining time to the destination.
Freeway Exit Preview	Sets the freeway exit preview to on or off.
Automatic Zoom	Sets whether to automatically enlarge the map when approaching intersections or turning points during route guidance on or off.
Auto-Hide Route Bar	Sets the route bar auto-hide function to on or off.
Route Preference	Sets the preferred route type when searching for a new route.
Avoid	Sets avoidance criteria for the route calculation.
Traffic Warning Tone	Sets the traffic alert sound to on or off.
Map Update	Sets the updating of the map data.

Checking for Map Updates

You can update the maps to the latest information. The maps should be checked and updated regularly for the best possible navigation experience.

At www.subaru-maps.com, you can update the entire USA map at once via USB. The maps can also be updated over the air. When updating over the air, you can update eight regions at a time. This allows you to update your home state without having to download the entire map program for the United States. This option is great if you normally stay in your home state and/or surrounding states.

SETTINGS AND UPDATES

Updating Over-the-Air

To check for available updates over-the-air, first connect to a Wi-Fi network (see page 123). Map updates can be found by selecting “Settings”, then “Navigation” on the Touchscreen.

1 For step by step directions for updating your maps through Wi-Fi, please refer to page 141.

Updating Maps Using Your PC/MAC

Maps can also be updated using a USB memory device, which will allow the entire map program to be updated at one time. This is a great option if you are going to take a cross-country trip and your maps have not been updated in a while.

To update the map using a USB memory device, start by going to www.subaru-maps.com.



Scan to learn
more about
Map Updates

CLOCK

Clock settings can be adjusted when the ignition is in the “ON” position. You can adjust the clock manually or set the clock to adjust automatically on the clock setting screen. To access the clock setting screen with a single step:

- 1 Select the clock on the status bar at the top of the Center Information Display.
- 1 For more information on clock settings and full step-by-step instructions on adjusting the clock both manually and automatically, please refer to page 119 in this Getting Started Guide.

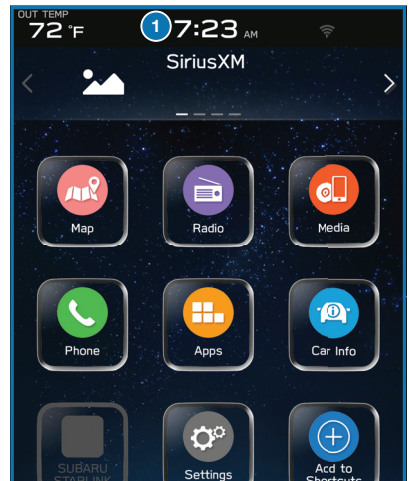

EYESIGHT

EYESIGHT® OVERVIEW

Your Subaru features a variety of safety systems that are the culmination of everything Subaru Engineers know about safety. These systems are referred to as “Driver Assist Technologies” and add confidence to every trip you and your passengers take. Working together, these systems provide enhanced awareness, safety, and convenience in front, to the sides, and behind your Subaru. Subaru Driver Assist Technologies include:

- EyeSight® Driver Assist Technology
- Rear-Vision Camera
- Pre-Collision Braking
- Automatic Emergency Steering
- Blind-Spot Detection (BSD)
- Rear Cross-Traffic Alert (RCTA)
- Reverse Automatic Braking (RAB)
(Automatic Transmission Models Only)
- High Beam Assist (HBA)
- Lane Departure Prevention
- Steering Responsive Headlights (SRH)

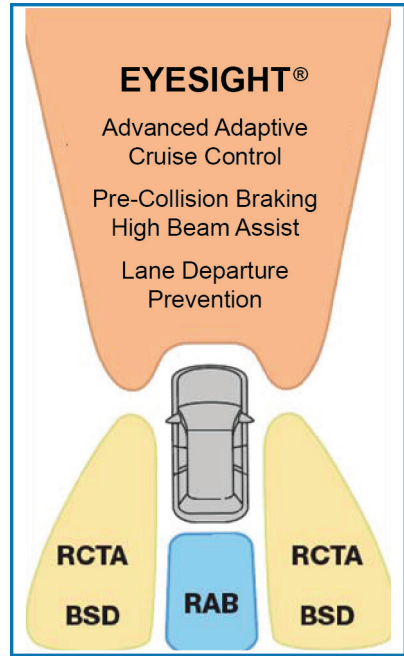

OPERATION

EyeSight® is a driver assist technology that uses dual stereo cameras to serve as an extra pair of eyes on the road ahead to identify vehicles in front, pedestrians, traffic lanes, or other objects. If need be, the EyeSight® system can apply the brakes and/or reduce engine power to help avoid or reduce the severity of a collision. During these events, the system will provide audible and visual alerts to assist you in making decisions.

Since the characteristics and limitations of the EyeSight® cameras are similar to human eyes, it is important that the cameras, windshield, and area in front of the cameras are treated with special care. Please refer to “Care and Limitations” on page 116 in this Getting Started Guide for more details.



EyeSight® Cameras (inside)



EyeSight® Cameras (outside)

FUNCTIONS

The EyeSight® system features several distinct functions designed to provide extra awareness, improve safety, reduce fatigue, and add peace of mind every time you drive your Subaru. EyeSight® functions include:

- Pre-Collision Braking (PCB)
- Pre-Collision Brake Assist
- Automatic Emergency Steering
- Pre-Collision Throttle Management (Automatic Transmission Models Only)
- Lane Departure Warning (LDW)
- Lane Sway Warning
- Lane Departure Prevention
- Advanced Adaptive Cruise Control with Lane Centering
- Conventional Cruise Control
- Lead Vehicle Start Alert

EYESIGHT

Pre-Collision Braking

This function helps prevent or minimize a frontal collision with another vehicle, pedestrian, or other objects by providing visual and audible warnings. Warnings are displayed in the Combination Meter Display (CMD) with audible beeps. If you take no corrective action, the system automatically reduces engine power and applies the brakes with increasing force to help prevent or minimize the collision.

The Pre-Collision Braking function may also assist with avoiding or reducing the severity of collisions with crossing pedestrians and cyclists and with oncoming vehicles and pedestrians when turning.

This system can be turned on or off in the Center Information Display (CID) (see page 110).

Automatic Transmission

Pre-Collision Braking can be activated when the select lever is in the “D” or “M” position. The lower limit for Pre-Collision Braking on automatic transmission vehicles is approximately 2 mph.

To override the system, press down on the accelerator pedal.

Manual Transmission

Pre-Collision Braking will activate regardless of whether the clutch pedal is engaged, or if the shift lever is in the “N” position or any forward gear.

The lower limit for Pre-Collision Braking on manual transmission vehicles is approximately 1 mph when in 1st - 6th gear. If the vehicle is in Neutral, or if the system is unable to detect what gear is engaged, Pre-Collision Braking will not activate at speeds lower than 5 mph.

Pre-Collision Braking will continue to control the vehicle until it stops, even if the engine stalls. The clutch pedal can be pressed to avoid stalling. Once the vehicle has stopped, the system will gradually release brake control, so be sure to apply the brakes if you want to keep the vehicle stopped.

To override the system, press down on the accelerator pedal while in any gear position.

Pre-Collision Braking is not a substitute for safe and attentive driving. You should always remain alert and keep your hands on the steering wheel at all times.

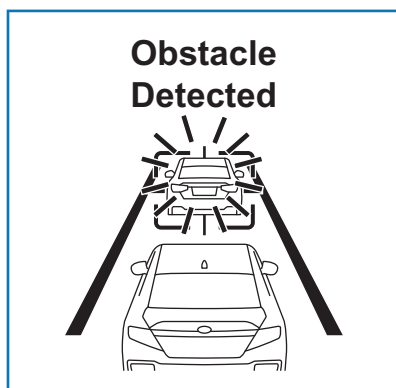

Pre-Collision Brake Assist

This function activates when the Pre-Collision Braking System is activated, the system determines that there is a high risk of collision with an obstacle in front, and you apply the brakes. The function assists by applying additional pressure to the braking system to decrease stopping distance.

This system can be turned on or off in the Center Information Display (CID) (see page 110).

Automatic Emergency Steering (if equipped)

The Automatic Emergency Steering function activates when the Pre-Collision Braking System has activated and there is an extremely high possibility of a collision with an obstacle ahead. When traveling at 50 mph or slower, the function uses the EyeSight® cameras and rear radar to determine if there is enough space to safely avoid a collision with the object ahead, detecting lane markings and making sure that there are no other objects in front as well as behind, such as oncoming vehicles or pedestrians.

Once activated, Automatic Emergency Steering provides automatic steering support to avoid the collision while staying within the lane. After a collision is avoided, the system continues steering assist and brake control to maintain the vehicle in its lane until the vehicle stops.

This function can be turned on or off by activating or deactivating the Pre-Collision Braking system (see page 110) or BSD/RCTA (see page 113).

Pre-Collision Throttle Management

This function is designed to help prevent you from unintentionally accelerating into a stopped vehicle or other obstacle by reducing engine power. Warnings are displayed in the Combination Meter Display (CMD) with audible beeps.

Pre-Collision Throttle Management is helpful when:

- You unintentionally place the select lever in the “D” position instead of the “R” position and start to accelerate toward a parked car, wall or parking structure.
- While you are at a stop, the vehicle ahead of you accelerates, but then suddenly slows down or stops as you begin to accelerate.

This system can be turned on or off in the Center Information Display (CID) (see page 110).

Pre-Collision Throttle Management is only available on vehicles with an automatic transmission.

EYESIGHT

Lane Departure Warning

This function provides audible and visual warnings if you are about to depart your lane of travel. Using the EyeSight® camera, the Lane Departure Warning function identifies lane markings when traveling at speeds of approximately 30 mph or greater. These warnings are displayed in the Combination Meter Display (CMD) with audible beeps. Lane Departure Warning does not provide any corrective actions.

You can turn this system on or off in the Center Information Display (CID) (see page 109).

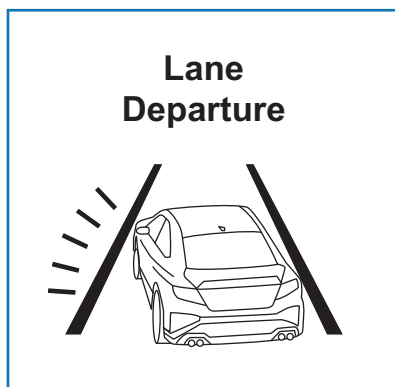

Lane Sway Warning

This function detects repetitive or unusual side-to-side vehicle movement within a lane of travel that may indicate a drowsy or inattentive driver. Using the EyeSight® camera, the Lane Sway Warning function activates to identify lane markings when traveling at speeds of approximately 37 mph or greater and deactivates when vehicle speed falls below 25 mph. Warnings are displayed in the Combination Meter Display (CMD) with audible beeps. Lane Sway Warning does not provide any corrective actions.

You can turn this system on or off in the Center Information Display (CID) (see page 109).

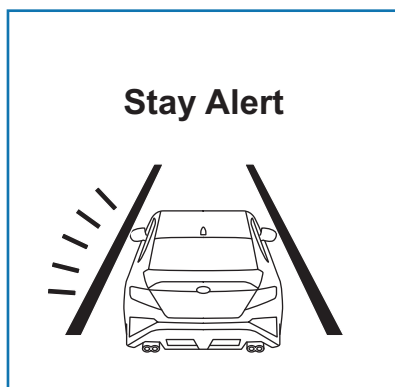

Lane Departure Prevention

This function provides steering assistance to keep your Subaru in its lane of travel when cruising on expressways, freeways, and interstate highways. Using the EyeSight® cameras, the Lane Departure Prevention Function identifies lane markings when traveling at speeds of approximately 37 mph or greater.

Operate the Center Information Display (CID) to turn on the Lane Departure Prevention Function by selecting “All Functions” or “Lane Departure Prevention Function Only” on the “Lane Departure Prevention Function” screen of the EyeSight® settings.

As you drive the vehicle above the minimum speed, white lane marking graphics on the CMD indicate that right and/or left lane markings have been successfully identified by the EyeSight® camera.

If your Subaru is about to depart the driving lane, the system assists steering by gently guiding the vehicle back into your lane. When the system is actively providing assistance, the lane indicator on the side where the Lane Departure Prevention Function activated changes from white to yellow.

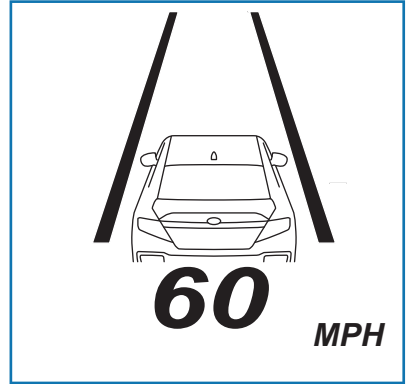

Advanced Adaptive Cruise Control with Lane Centering

Advanced Adaptive Cruise Control is a driving support system intended to reduce the burden on you when driving on an expressway (including during congestion and when driving at high speed). Advanced Adaptive Cruise Control and Lane Centering work together to assist you by automatically controlling the accelerator, brake, and steering.

EYESIGHT

Advanced Adaptive Cruise Control

This system provides cruise control with the ability to keep a safe distance from the car in front of you. Using the EyeSight® camera, the Advanced Adaptive Cruise Control function identifies vehicles in front of you in the same lane, and your vehicle follows the vehicle in front (up to the maximum of your set speed). While following, your vehicle will automatically maintain a following distance that corresponds to the speed of the vehicle in front.

You can turn the Advanced Adaptive Cruise Control on or off using the Adaptive Cruise Control On/Off button on the right side of the steering wheel (see page 107). Once the system is turned on, a white Adaptive Cruise Control icon will be displayed on the Combination Meter Display (CMD). When all the operational conditions are met, “READY” appears underneath the Adaptive Cruise Control icon.

To set Advanced Adaptive Cruise Control, push down the “SET/-” switch on the right side of the steering wheel. The CMD will indicate a target speed and the icon will turn green. This speed can be adjusted up or down using the “RES +/SET -” switch (see page 107).

When a vehicle in front of you is identified, a Lead Vehicle indicator will be displayed on the Combination Meter Display (CMD). You can change the desired following distance from the lead vehicle by pressing the “Increase Distance” or “Decrease Distance” buttons (see page 107).

Automatic Transmission

On automatic transmission vehicles, Adaptive Cruise Control can be set at any speed above 0 mph.

Manual Transmission

On manual transmission vehicles, Adaptive Cruise Control can be set at speeds of 20 mph or higher, as long as the shift lever is in 2nd - 6th gear. You can switch gears freely while the system is operating.

Vehicle acceleration will be paused momentarily when the clutch pedal is depressed, but acceleration will resume when the clutch is engaged again. If the clutch pedal is pressed for more than 5 seconds, or if the select lever is placed in Neutral for more than 5 seconds, the Adaptive Cruise Control system will cancel. The system will also cancel if the engine RPM approaches the red line.

NOTE: If the vehicle speed falls below 16 mph, the Adaptive Cruise Control system will cancel and brake and/or clutch operation may be required.

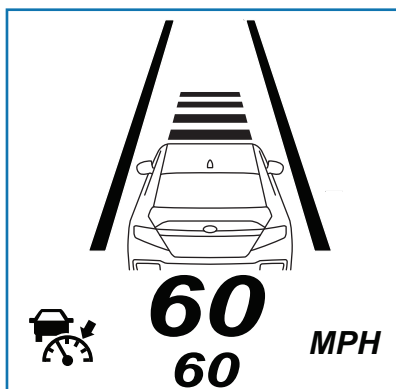

Lane Centering

The stereo camera detects lane markings (including Botts' dots) of the lane and the lead vehicle, and the system assists the steering operation by working with the electric power steering to help keep your vehicle in its lane when driving on expressways, freeways and interstate highways.

This function can be used by pressing the Lane Centering switch when Advanced Adaptive Cruise Control is activated. When driving at speeds of 0 mph to approximately 90 mph, the system detects the lane markings and/or the lead vehicle and assists you with steering in order to keep the vehicle close to the center of the lane.

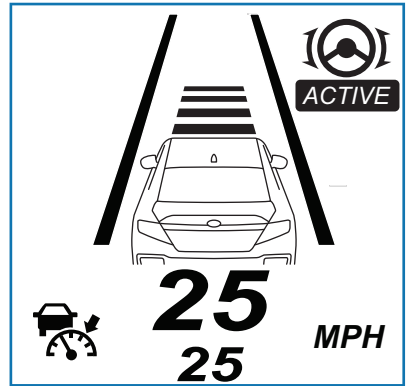

Conventional Cruise Control

Conventional Cruise Control maintains a constant traveling speed you set, but it does not adapt to the other vehicles in front of you. To activate Conventional Cruise Control, press the Adaptive Cruise Control On/Off button to set Advanced Adaptive Cruise Control into standby status. Then, with Advanced Adaptive Cruise Control in standby status, press and hold the "Increase Distance" or "Decrease Distance" button on the steering wheel for approximately two seconds.

The Cruise Control indicator on the Combination Meter Display (CMD) will change from the Adaptive Cruise Control icon to the Conventional Cruise Control icon, and the "READY" indicator appears when all operational conditions are met. Use the accelerator to reach the desired speed, then use the RES +/SET - switch to set the vehicle speed.

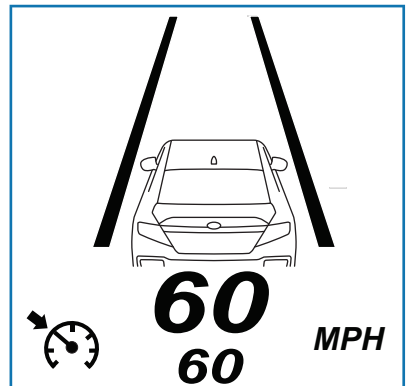

EYESIGHT

Lead Vehicle Start Alert

This function will provide a visual and audible alert when a stopped vehicle in front of you begins to move, and your vehicle remains stationary. Warnings are displayed in the Combination Meter Display (CMD) with audible beeps. Lead Vehicle Start Alert is helpful in situations where you may become temporarily distracted at a traffic light, and the vehicle ahead begins to move.

Navigate the CID (select “Settings”, and then the “Car” menu) to access the EyeSight® settings menu to turn this function on or off.

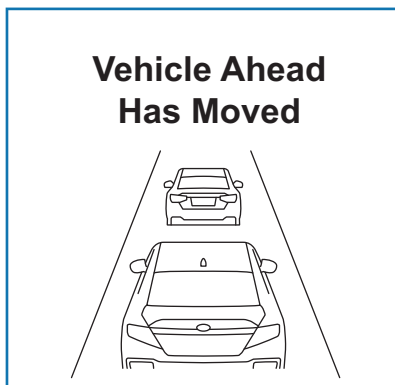

Automatic Transmission

This function only activates when the select lever is in the “D”, “M”, or “N” position.

Manual Transmission

This function only activates when the brake pedal is depressed. The system will activate even if the engine stalls.

STEERING WHEEL CONTROLS

Advanced Adaptive Cruise Control

- 1 **Adaptive Cruise Control On/Off:** Press to turn Advanced Adaptive Cruise Control on or off.
- 2 **Lane Centering:** Press to turn on or off Lane Centering when Advanced Adaptive Cruise Control is active.
- 3 **Increase Distance:** Press to increase the following distance setting while using Advanced Adaptive Cruise Control. Press and hold to change to Conventional Cruise Control.
- 4 **Decrease Distance:** Press to decrease the following distance setting while using Advanced Adaptive Cruise Control. Press and hold to change to Conventional Cruise Control.
- 5 **Resume (RES)/Increase Speed and Set (SET)/Decrease Speed:** Press the switch down to set an initial target speed. Once set, press up or down to adjust the target speed.
 - **Adjust by 1 mph:**
 - Briefly press the switch up to increase the target speed in increments of 1 mph.
 - Briefly press the switch down to decrease the target speed in increments of 1 mph.
 - **Adjust by 5 mph:**
 - Press and hold the switch up to increase the target speed in increments of 5 mph.
 - Press and hold the switch down to decrease the target speed in increments of 5 mph.



Advanced Adaptive Cruise Control Switches

EYESIGHT

Customizing EyeSight® Settings

The EyeSight® system features customization of certain preferences and warnings. Select “Settings”, and then “Car” or select the “Car Settings” icon to adjust a number of EyeSight® Settings in the Center Information Display, such as:

- Warning Volume: Min/Mid/Max
- Cruise Control Acceleration Characteristics (if equipped):
 - Lv. 1 Eco
 - Lv. 2 Comfort
 - Lv. 3 Standard
 - Lv. 4 Dynamic

EYESIGHT® ASSIST MONITOR (EAM) (if equipped)

The EyeSight® Assist Monitor (EAM) provides a heads-up display of EyeSight® system functions in the lower windshield area allowing you to keep your eyes on the road ahead.

The EAM indicators can be changed by selecting “Settings”, then “Car” to access the “EyeSight® Assist Monitor” settings menu in the Center Information Display. Below are the indications provided by the EAM function:

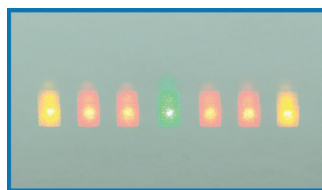

LED COLOR	PATTERN	WARNING CONDITION
Green	Solid illumination	A vehicle is detected ahead while Advanced Adaptive Cruise Control is operating.
Yellow	Flashing on one side	Lane Departure Warning is operating. The side where the vehicle has left its lane flashes, and the side that has not left its lane illuminates.
	Flashing alternately	Lane Sway Warning is operating.
	Flashing simultaneously	<ul style="list-style-type: none">• Steering wheel operation is not be detected for a certain period of time.• Lane Centering or Lane Departure Prevention Function was canceled automatically by the system (flashing rapidly).

LED COLOR	PATTERN	WARNING CONDITION
Red	Flashing simultaneously (4 indicators)	<ul style="list-style-type: none"> Following Distance Warning, Pre-Collision Braking System (first or secondary braking), Automatic Emergency Steering (if equipped), Obstacle Detected Warning, or Pre-Collision Throttle Management is operating. Lane Centering Function was canceled when there was no operation of the steering wheel.
	Flashing on one side	Lane Centering Function is active and the vehicle appears likely to depart the lane. The side where the vehicle has left its lane flashes, and the side that has not left its lane illuminates.

LANE DEPARTURE WARNING AND PRE-COLLISION BRAKING SYSTEM OFF

Lane Departure Warning OFF

Select the “Car Settings” icon, and then in the “Driving Assistance” menu, select “Lane Departure” to choose your desired operation setting for Lane Departure Prevention, Lane Departure Warning, and Lane Sway Warning.

Lane Departure Warning/Lane Sway Warning are turned on by selecting “All Functions” or “Warning Buzzer Only.” Lane Departure Warning/Lane Sway Warning are turned off by selecting “Lane Departure Prevention Function Only” or “OFF.”

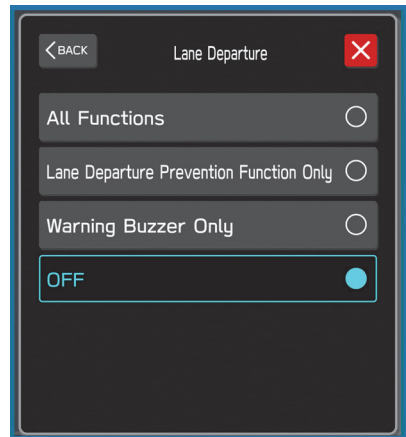

When these functions are off, a yellow Lane Departure Warning OFF indicator illuminates in the Combination Meter. It may be helpful to turn these functions off when lane markings on the road are inconsistent.



EYESIGHT

Pre-Collision Braking System OFF

Select the “Car Settings” icon, and then in the “Driving Assistance” menu, select “Pre-Collision Braking” to choose your desired setting for the Pre-Collision Braking functions.

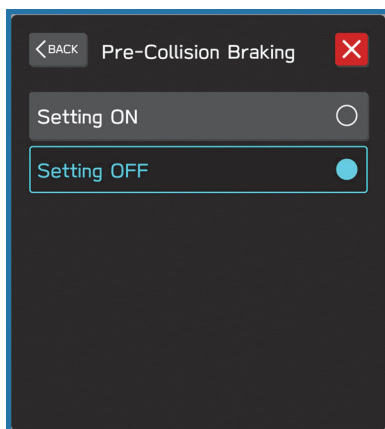

When these functions are off, a yellow Pre-Collision Braking OFF indicator illuminates in the Combination Meter. Deactivating the Pre-Collision Braking system also deactivates Automatic Emergency Steering, if equipped. When Automatic Emergency Steering is turned off, the Automatic Emergency Steering OFF indicator is displayed in the Combination Meter. It may be helpful to turn these functions off when using a drive-through carwash.



DRIVER ASSIST TECHNOLOGIES

REAR-VISION CAMERA

This function provides a clear view of the area behind the vehicle to help avoid obstacles. Using a wide-angle camera mounted on the rear of the vehicle, an image is automatically displayed on the multimedia screen when you place the select lever/shift lever in the “R” position. The displayed image features a centerline indicator, colored distance markers, and dynamic guidelines that move as the steering wheel is turned.

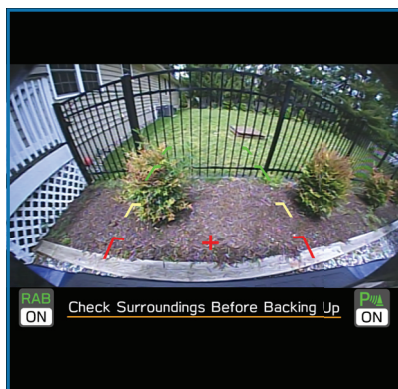

BLIND SPOT DETECTION (BSD) / REAR CROSS TRAFFIC ALERT (RCTA) (if equipped)

This system uses radar sensors mounted behind the rear bumper on the left and right sides that warn you if another vehicle is sensed in your blind spots. These functions provide additional awareness when changing lanes or driving in reverse.

Blind Spot Detection (BSD)

Blind Spot Detection senses if a vehicle is traveling at the same relative speed in your blind spot and provides a visual warning. If the system detects a vehicle in your blind spot, the BSD/RCTA approach indicator light in the corresponding side mirror frame illuminates. If you operate the turn signal lever in the direction the BSD/RCTA approach indicator light is illuminated, the system provides an additional level of warning by rapidly flashing the BSD/RCTA approach indicator light.



DRIVER ASSIST TECHNOLOGIES

Lane Change Assist (LCA)

Lane Change Assist (LCA) provides an additional level of protection by warning you of rapidly approaching vehicles in the neighboring lanes. If LCA detects a vehicle approaching at a high speed in the neighboring lanes, the BSD/RCTA approach indicator light in the corresponding side mirror frame illuminates. If you operate the turn signal lever in the direction the BSD/RCTA approach indicator light is illuminated, the system rapidly flashes the BSD/RCTA approach indicator light.

Rear Cross Traffic Alert (RCTA)

This function detects a vehicle approaching from either side as you reverse, helping you check the rear and side areas of the vehicle when moving backward. If RCTA detects a vehicle approaching from either side while moving backward, the system provides visual and audible warnings: The BSD/RCTA approach indicator light(s) on the side mirror(s) flash, the BSD/RCTA warning indicator appears in the upper corner of the Rear-Vision Camera display, and a warning buzzer sounds.



DRIVER ASSIST TECHNOLOGIES

Blind Spot Detection / Rear Cross Traffic Alert OFF

BSD/RCTA can be turned on or off in the Center Information Display (CID):

- 1 Select the “Car Settings” icon.
- 2 In the “Driving Assistance” menu, select “BSD/RCTA” to turn the function on or off.

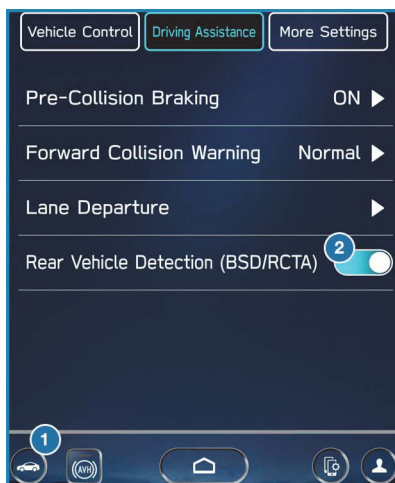

When these functions are off, a yellow BSD/RCTA OFF indicator will be displayed in the Combination Meter. Deactivating BSD/RCTA also deactivates Automatic Emergency Steering, if equipped. When Automatic Emergency Steering is turned off, the Automatic Emergency Steering OFF indicator is displayed in the Combination Meter.



DRIVER ASSIST TECHNOLOGIES

HIGH BEAM ASSIST (HBA)

This function uses the EyeSight® cameras to automatically switch the headlights between high and low beam settings, enhancing safety for both you and other drivers on the road. To activate High Beam Assist, set the headlight control switch to the “AUTO” position and push the headlight lever forward to the high beam position and release. The green HBA indicator illuminates on the Combination Meter.



HBA automatically activates the high beams when the following conditions are met:

- The forward area is dark
- There are no preceding/oncoming vehicles or sharp curves in the road
- Your speed is approximately 20 mph or greater (22 mph models without EyeSight®).

HBA automatically switches to low beams when the following conditions are met:

- A preceding/oncoming vehicle is detected
- The forward area is bright
- Your speed decreases to 10 mph or less (17 mph models without EyeSight®)
- The EyeSight® system is malfunctioning or is temporarily stopped.

STEERING RESPONSIVE HEADLIGHTS (SRH)

(if equipped)

The Steering Responsive Headlights (SRH) system aims the headlight beams in the direction you are steering, improving visibility at corners and intersections when driving at night. You can turn the SRH system on or off in the Center Information Display through the “Car Settings” icon.

 For more information, please refer to “Instruments and Controls” in your Owner’s Manual.

DRIVER ASSIST TECHNOLOGIES

REVERSE AUTOMATIC BRAKING (RAB) (if equipped)

This system uses four rear bumper mounted sonar sensors to detect objects when moving between 1 and 9 mph in reverse. RAB uses the Rear-Vision Camera image to display colored proximity alerts when an object is detected. As an object becomes closer to the rear of your vehicle, audible beeps provide additional awareness in progressive levels. If RAB determines that a collision with an object is possible, the system can automatically apply the brakes to help prevent or minimize the impact.

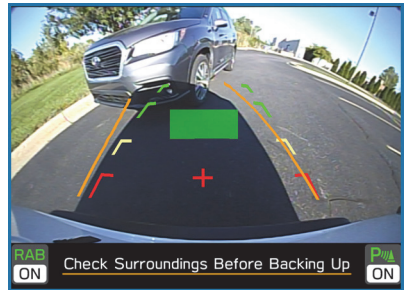

RAB is only available on vehicles with an automatic transmission.

Reverse Automatic Braking (RAB) OFF

In some cases, it may be helpful to temporarily turn the system off. RAB can be turned off using the buttons on the Touchscreen when the select lever is in the “R” position.

Select and hold the “RAB ON” button until it changes to “RAB OFF” to disable the automatic braking functions of the RAB system.

Select and hold the “P))) ON” button until it changes to “P))) OFF” to disable the audible beeping of the RAB system.



CARE AND LIMITATIONS

STEREO CAMERA PRECAUTIONS

Your EyeSight® stereo cameras are precision components that must be kept free from obstruction and contamination, such as fingerprints or cleaning solutions. When the system detects that the stereo camera lenses are impaired, a malfunction indicator will be displayed and EyeSight® functions will not be available.

When you are in the vicinity of the EyeSight® stereo cameras, always observe the following precautions:

- Do not touch or attempt to clean the EyeSight® camera lenses inside the vehicle. Extra caution should be used when cleaning the inside of the windshield. Over-spray from cleaning solutions may impair or even damage the camera lenses. When cleaning the inside of the windshield around the camera cover, do not spray cleaner directly onto the windshield. Instead, spray cleaner onto a cloth and then wipe the windshield. Please inform others who may attempt to clean the windshield, such as car wash staff, of these precautions.
- If the inside of the windshield in front of the stereo camera is dirty, do not try to clean the windshield yourself. Contact your Subaru retailer to have the vehicle inspected.
- If the camera system becomes hot, the cooling fans may operate. Do not block or insert anything into the ventilation holes. Do not touch the camera cover, because it may be hot due to heat generated by the camera system.
- Electronic Toll Collection devices, such as EZPass™, must be installed in an area that does not obstruct the stereo cameras' field of vision. See "Prohibited Area" on page 117.
- Adjust the rearview mirror so it does not obstruct the stereo cameras' field of vision.
- Do not install any interior rearview mirror accessories, such as a wide-type mirror or hanging objects. Only approved Genuine SUBARU accessories may be installed.

For more detailed information, please refer to your EyeSight® Owner's Manual.

WINDSHIELD GLASS AND DASHBOARD

Since the characteristics and limitations of the EyeSight® stereo cameras are similar to human eyes, it is important that the area in front of the cameras be kept free from dirt, scratches, cracks, fogging, or accessories mounted to the windshield, hood or dashboard. Visual impairments or reflections can affect EyeSight® system performance. Extra caution should be taken when cleaning the windshield to prevent over-spray from cleaning solutions.

The image in the following section outlines those areas that must be kept clean and free from obstruction. Please refer to the Owner's Manual for a complete listing of limitations.

WRX

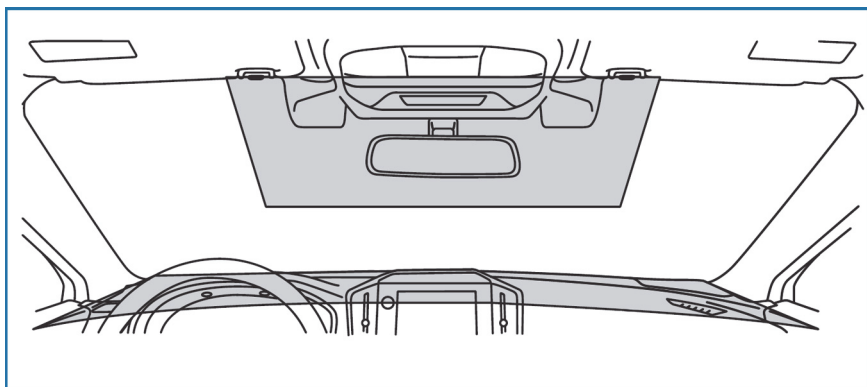

Do not place stickers or objects in the prohibited area (in gray).

EYESIGHT DISCLAIMER

EYESIGHT® DISCLAIMER

EyeSight® is a driver assist technology which may not operate optimally under all driving conditions. The driver is always responsible for safe and attentive driving. System effectiveness depends on many factors such as vehicle maintenance, weather and road conditions. See Owner's Manual for complete details on system operations and limitations.

The Pre-Collision Braking system is designed to provide automatic braking that either prevents a collision or reduces the severity of a frontal impact.

The Pre-Collision Throttle Management system is designed to reduce acceleration and minimize the severity of certain frontal impacts.

Advanced Adaptive Cruise Control and Brake Light Recognition are designed to assist the driver and are not substitutes for safe and attentive driving.

Lane Centering function operates only when used in conjunction with Advanced Adaptive Cruise Control.

Lane Departure Prevention operates only when the lane markings are visible, and system effectiveness depends on many factors.

Blind-Spot Detection, Lane Change Assist and Rear Cross Traffic Alert are systems designed to assist the driver by monitoring the rear and side areas of the vehicle during a lane change or reversing and are not a substitute for safe and attentive driving.

The Reverse Automatic Braking System is not a substitute for safe and attentive driving. System effectiveness depends on many factors, such as vehicle maintenance, weather and road conditions. Always exercise caution and use vehicle mirrors and the Rear-Vision Camera when backing up. See Owner's Manual for complete details on system operation and limitations.

HOW TO OVERVIEW

This “How To” appendix provides detailed, step-by-step instructions to easily connect with features of your WRX.

If you need some help with these features or want to learn more, we are here to assist you:

Your Subaru Owner’s Manuals:

Located in the glovebox

Online Subaru Owner’s Resources:

www.subaru.com/owners

Subaru Customer Support:

www.subaru.com/customer-support

1-800-782-2783 (1-800-SUBARU3)



Scan to learn more about **Owner's Resources**.



Scan to learn more about **Customer Support**.

SETTING THE CLOCK

Clock settings can be adjusted when the ignition is in the “ON” position. You can adjust the clock manually or set the clock to adjust automatically in the clock setting screen.

To directly access the clock setting screen, you can select the clock on the status bar at the top of the Center Information Display. Full directions for accessing the clock settings and adjusting the clock manually or automatically are given in the following sections.

 For more information, please refer to “Quick Guide” in your STARLINK® Owner’s Manual.

HOW TO APPENDIX

Manually

To set the clock manually:

- 1 Select the Clock Display in the Status Bar.



- 2 Select "Time Setting".

NOTE: On this screen, you can also adjust the clock format (12H or 24H) and, for vehicles with navigation, adjust the time zone and Daylight Saving Time. The recommended settings for these are "Auto."

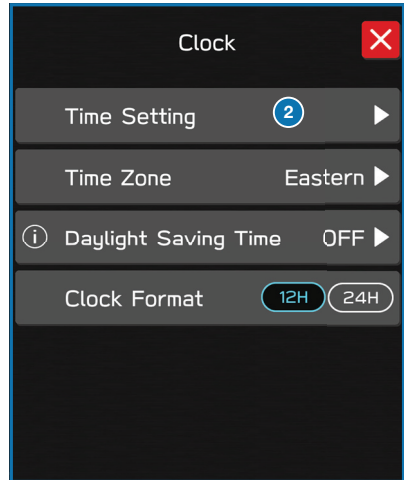

HOW TO APPENDIX

- 3 Select "Manual".
- 4 Adjust the time and date using the "Arrow Up" and "Arrow Down" buttons.
- 5 Once you are finished, select "OK".

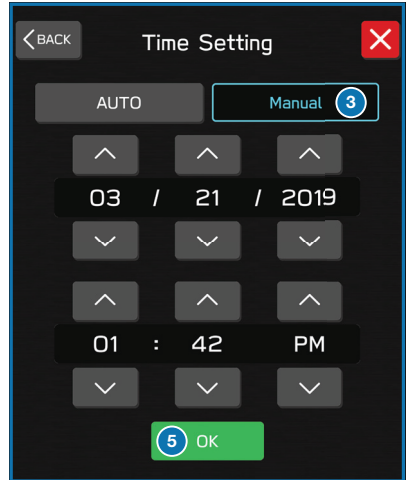

Automatically

To set the clock automatically:

- 1 Select the Clock Display in the Status Bar.

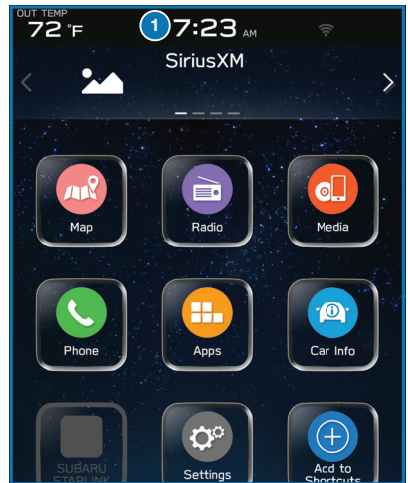

HOW TO APPENDIX

- 2 Select "Time Setting".

NOTE: On this screen, you can also adjust the clock format (12H or 24H) and, for vehicles with navigation, adjust the time zone and Daylight Saving Time. The recommended settings for these are "Auto."

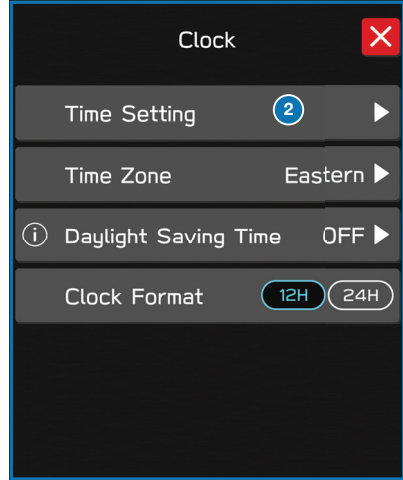

- 3 Select "Auto" or "Sync With Phone".

- 4 Select "Back".

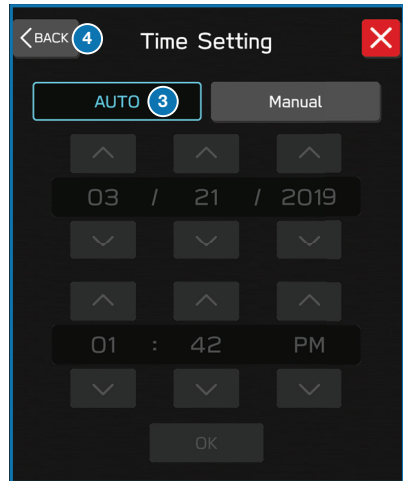

The clock automatically adjusts as follows:

- 11.6-inch display with navigation system: Automatically adjusts the clock when a GPS signal is available.
- 11.6-inch display without navigation system: Automatically adjusts the clock when a STARLINK® Safety and Security signal is available. Without STARLINK® Safety and Security, the clock automatically adjusts when a phone is paired and connected via Bluetooth®. “Phonebook Download” must be enabled in the Phone Settings.
- Dual 7.0-inch display: The clock automatically adjusts when a phone is paired and connected via Bluetooth®. “Phonebook Download” must be enabled in the Phone Settings.

WI-FI

Connecting to a Wi-Fi Network (Navigation Models Only)

- 1 On the Home Screen, select “Settings”.
- 2 In the “General” settings menu, select “Wi-Fi Settings”.



HOW TO APPENDIX

- 3 Make sure that Wi-Fi is enabled, then select “Available Wi-Fi Networks”.

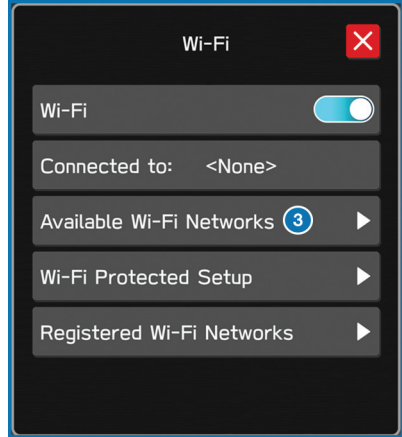

- 4 Select the desired network. When selecting a network with the lock icon, a screen will appear for you to enter the password, then select OK.

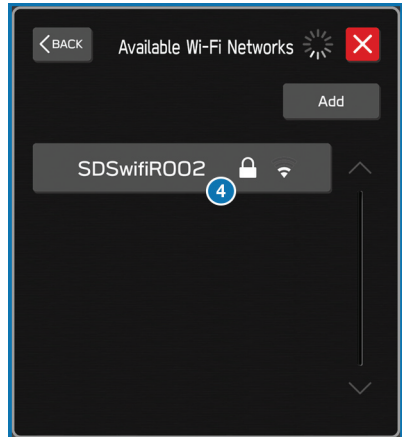

Wi-Fi Hotspot Subscription (if equipped)

Internet access is purchased separately through AT&T with monthly, per gigabyte, and unlimited data options available. Existing AT&T customers have the option to add an additional line to their AT&T Mobile Share plan. Available on select models.

Shortly after you take delivery of your new Subaru, you will receive an email from AT&T for a one month free trial and how to activate your free trial. To set up and enroll:

1. Select “Settings” on the Home screen.
2. Select “Wi-Fi Hotspot” to turn it on (if the Wi-Fi Hotspot is already on then proceed to the next step).
3. Adjust or update the following settings:
 - Wi-Fi Network Name (SSID)
 - SSID Broadcast (Network ON / OFF)
 - Security Type (WPA / WPA2)
 - Password
 - Connected Devices (Maximum of 8 devices)
 - Broadcast Frequency

How to enroll:

1. Connect your tablet, smartphone or laptop to the SUBARU STARLINK® Wi-Fi Hotspot network listed in the settings menu and open your preferred web browser on the device connected.
2. Once the SUBARU STARLINK® Wi-Fi Hotspot homepage loads, follow the on-screen instructions to create a new account or to add your vehicle to an already existing AT&T Wireless account. You can also subscribe to the Wi-Fi Hotspot from the MySubaru website or Mobile App.

 You can also visit an AT&T store or their website for more information at:
<https://myvehicle.att.com/#/subaru/learn?country=US&language=en>



Scan to learn
more about
AT&T plans

HOW TO APPENDIX

MAPS (if equipped)

Creating Home/Work

You can create a home address and work address through the Map screen:

- 1 Select the Map button on the home screen to display the map.

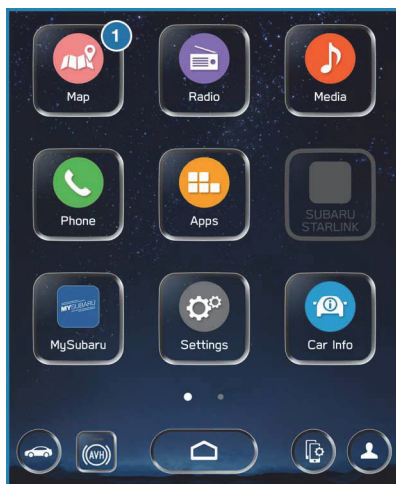

- 2 Select the Menu button.

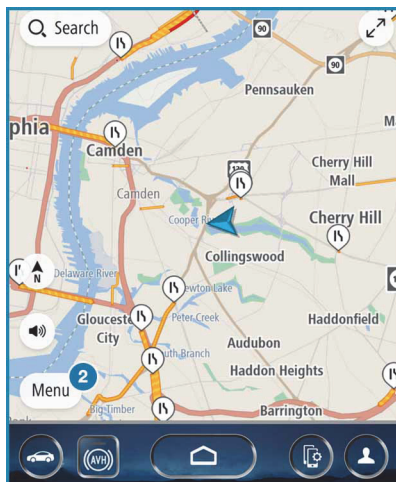

HOW TO APPENDIX

- 3 Select the Add Home or Add Work button.

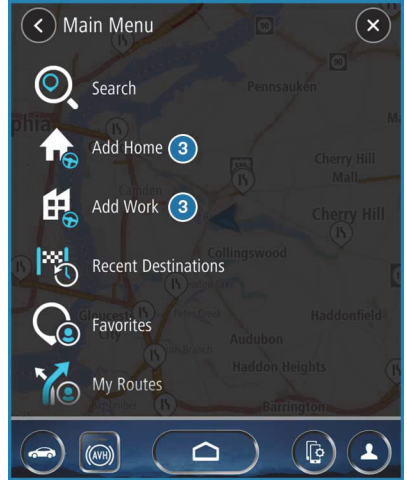

- 4 Use the keypad to enter the address. Results will be listed below. Select the address once it is displayed.

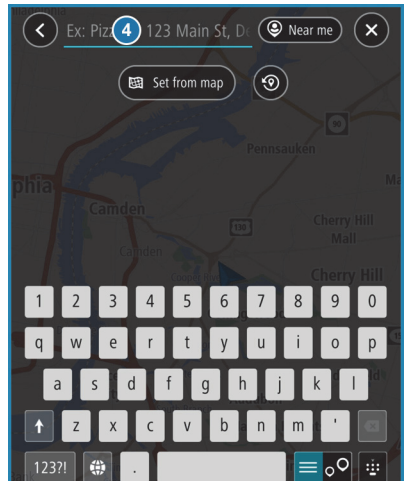

HOW TO APPENDIX

- 5 Select the Home or Work icon to save the location as home or work.

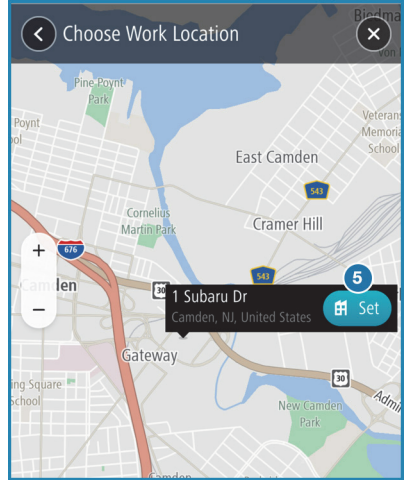

Searching for a Destination

Follow these steps to search for a destination:

- 1 Select the Map button on the home screen to display the map.

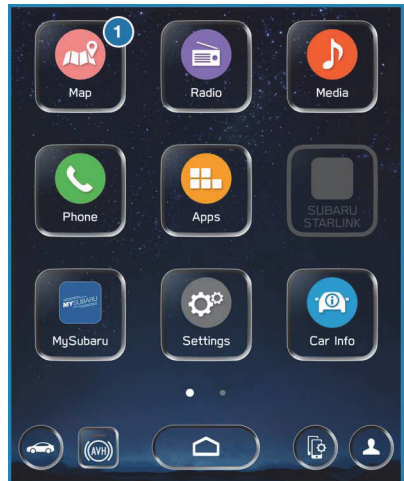

HOW TO APPENDIX

- 2 Select the search button to begin your search.

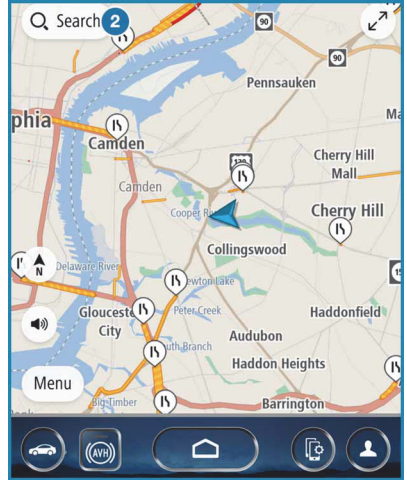

- 3 Use the keypad to enter the address or search by name/category (e.g., restaurant or park). Results will be listed below. Scroll, if needed, to find the address/destination, and select it.

- Selecting “Near Me” allows you to set the search radius filter. Once the filter is set, the search will only be performed for items within the chosen option: Whole Map, Near Me, In Town or City, Along Route, Near Destination, or Latitude/Longitude. You may need to change the setting if your destination is beyond the scope of the search radius filter.
- Selecting the “X” will exit the search and display the current vehicle location on the map.

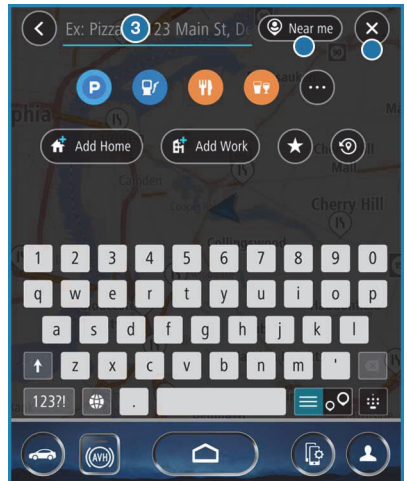

HOW TO APPENDIX

- 4 Select “Go” when the destination appears on the map.

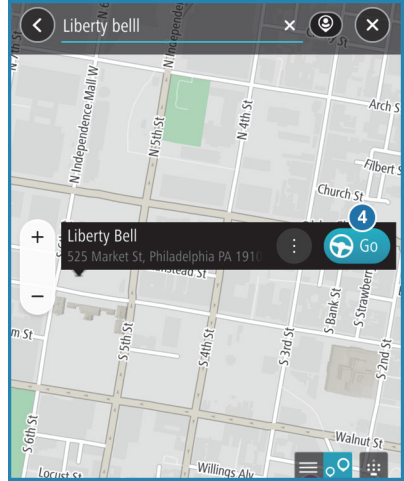

- 5 Three route options are provided for your destination. Choose your preferred route and select “Go” to begin route guidance.

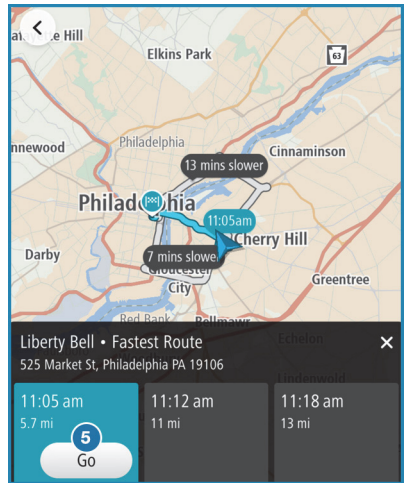

Finding a Location with What3Words

Follow these steps to search for a destination:

- 1 First, using your phone or computer, select your desired location in the What3Words website/app, which displays the three corresponding words.

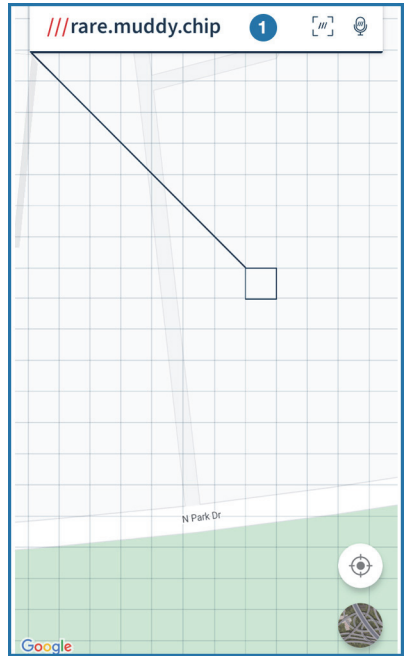

HOW TO APPENDIX

- 2 Next, open the map screen in the Center Information Display and select the Search button.

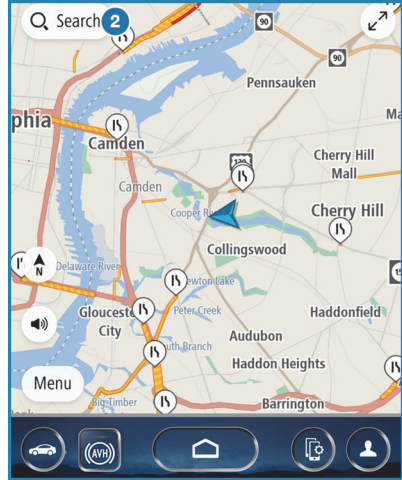

- 3 Use the keypad to enter the three words, separated by periods, associated with your location. Results will be listed below. Select the location.



HOW TO APPENDIX

- 4 Select “Go” when the location appears on the map.

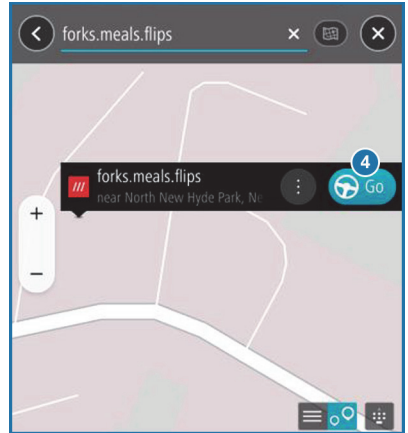

- 5 Three route options are provided for your destination. Choose your preferred route and select “Go” to begin route guidance.

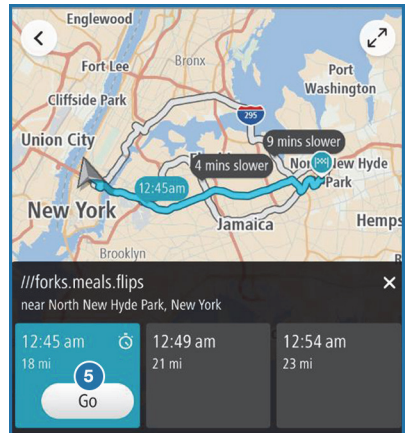

HOW TO APPENDIX

Route Options

You can set the navigation system to avoid certain types of routes:

- 1 On the home screen select “Settings”, then “Navigation”.
- 2 Select “Avoid”.



- 3 Select the desired item to avoid.

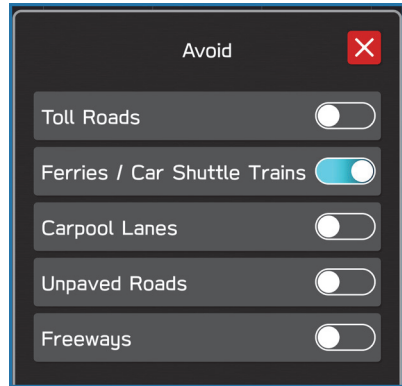

Route Preference

You can set the route preferences to search for the route that is fastest, shortest, or most eco-friendly:

- 1 On the home screen, select “Settings”.
- 2 Select “Navigation”.
- 3 Select “Route Preference”.

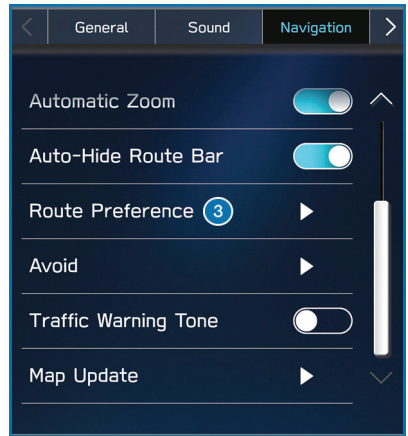

- 4 Select your route search preference.

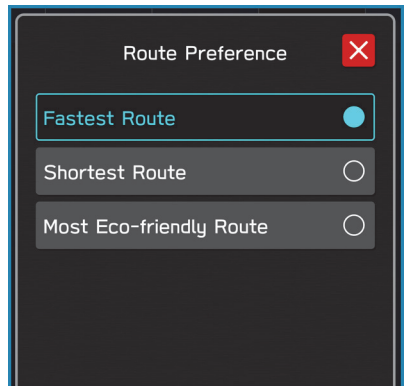

HOW TO APPENDIX

Saving Destination as a Favorite

The registered points can be set as a destination. To save a location from the Map screen:

- 1 Select the Menu button.

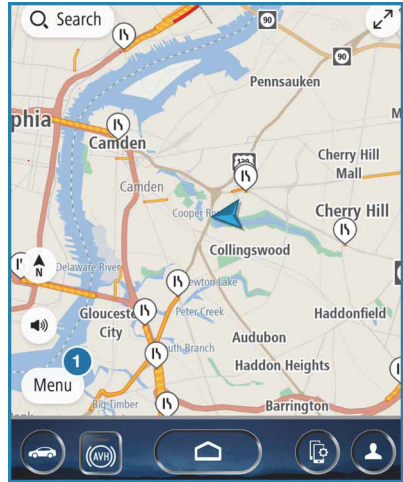

- 2 Select the Favorites button.

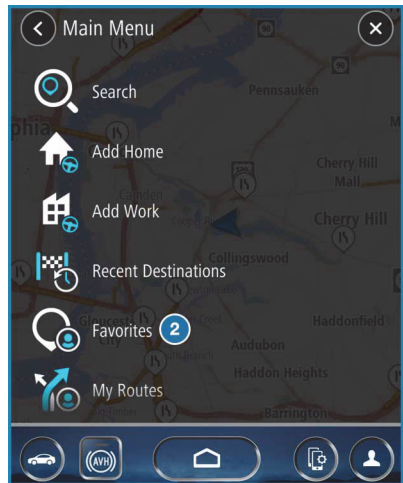

HOW TO APPENDIX

- 3 Select "Add".

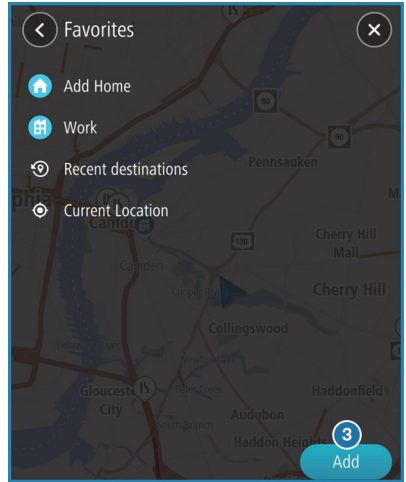

- 4 Type the address or name of the place you want to save. Results begin to appear below as you type. Select the address when it appears.

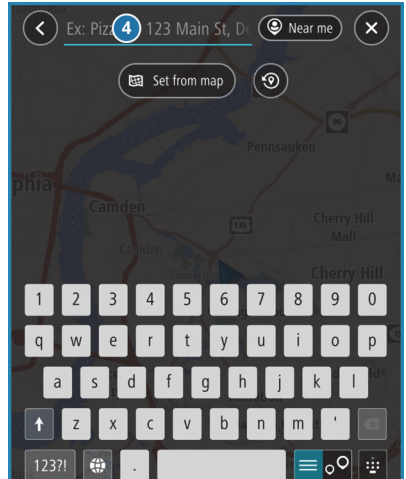

HOW TO APPENDIX

- 5 Select the icon on the address to save to favorites. You can rename the location or use the address as the location name. Select OK when finished.

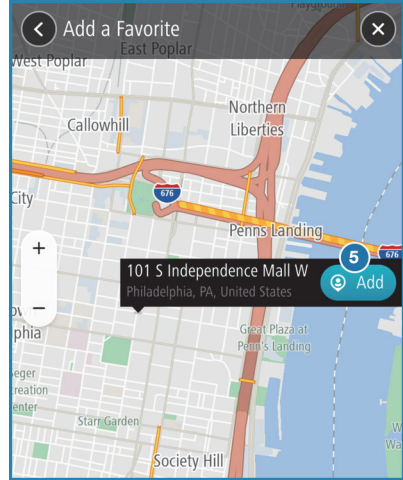

Guidance Screen Icons

These are the common icons used for the navigation guidance.

ICON	EXPLANATION	ICON	EXPLANATION
	Turn left/right.		Go straight ahead at the intersection.
	U-turn.		Exit at the junction.
	Keep left/right at the fork in the road.		Roundabout.
	Turn left/right & sharp curve.		You have arrived at your destination.
	Stay in the left/right lane.		You have arrived at your waypoint.

Map Zoom

You can zoom in or out on the map by “pinching-in” or “pinching-out.” Place two fingers on the screen and move them apart to zoom in. Place two fingers on the screen and move them closer together to zoom out. You can also zoom in or out on the map by tapping anywhere on the map, and then selecting the “+” or “-” buttons.

You can enlarge the map to cover the top portion of the screen by selecting the full screen button in the corner.

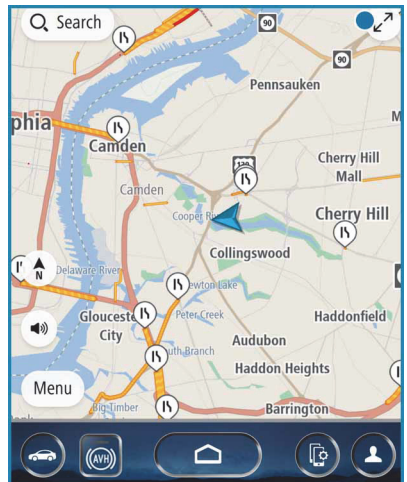
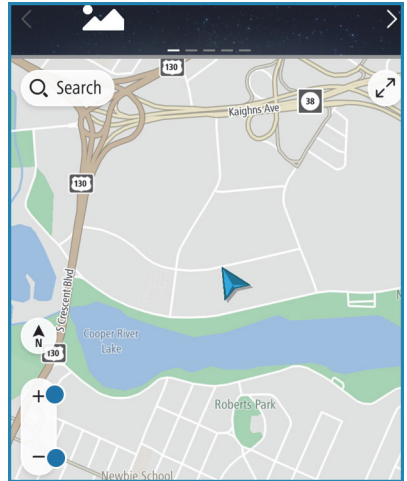

HOW TO APPENDIX

Map View/Perspectives

The orientation of the map can be changed between 2D north-up, 2D heading-up, and 3D heading-up. To change the view, select the map view icon. Each time the icon is touched, the view will change. The direction of the arrow indicates north when in 2D heading-up and 3D heading-up modes.

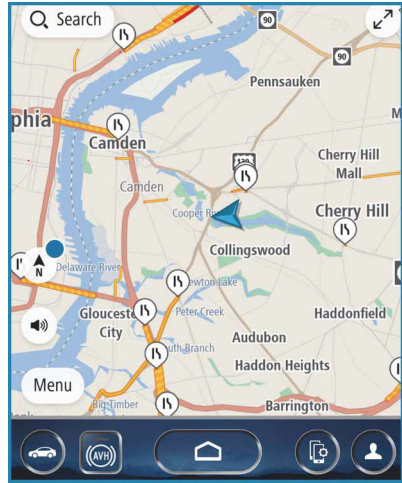

Traffic Information

Road sections affected by traffic conditions are displayed in a different color on the map, and a small icon representing the type of traffic condition is displayed above the road.

To receive the data service information in the vehicle, a subscription to the SiriusXM[®] Traffic Services is required following a free trial.

Nearest Gas Station

When driving on the highway during route guidance, information on gas stations, restaurants, or rest areas will be displayed on the right.

Select the desired item from the list, and then select “Add Stop” to add to your current trip. Select “GO” to change your destination to the new item.

Arrival Distance / Time

Displays the distance to the destination and/or the estimated arrival time at the destination.

This is customizable by selecting “Settings” on the home screen, then “Navigation” and finally “Arrival Distance / Time”.

Canceling Guidance

To cancel guidance, select “End”.

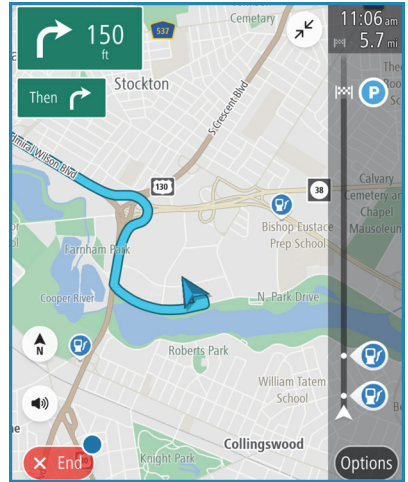

Map Updates

For vehicles with the 11.6-Inch Multimedia Navigation system, the maps can be updated over a Wi-Fi network, either manually or automatically.

1 For more information, please refer to “Navigation System (if equipped)” in your STARLINK® Owner’s Manual.

To update your maps automatically over Wi-Fi, follow this process:

- 1 First, make sure you are connected to a Wi-Fi Network (see page 123). Return to “Settings”, and then select the “Navigation” menu.
- 2 Select “Map Update”, select “Wi-Fi” and then select “Automatic Update”.

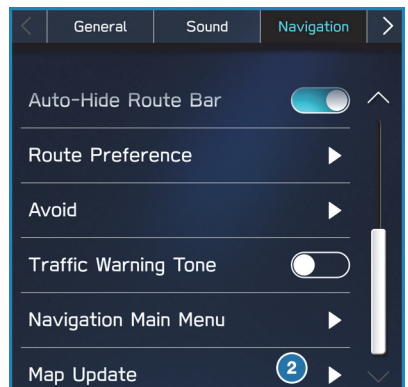

HOW TO APPENDIX

- 3 Select “Update maps automatically (at most 8 maps can be selected)” and then select the regions you would like to update.

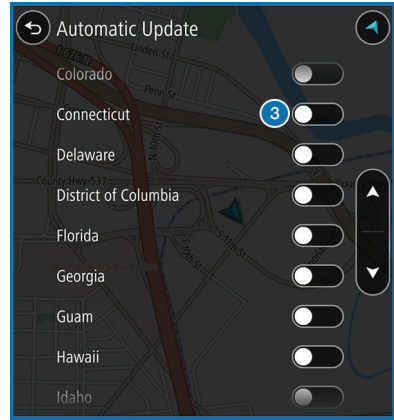

After the updates have been completed, turn the ignition switch to the “LOCK” / “OFF” position and exit the vehicle. Close the driver’s door and lock the doors. Then, move at least 10 feet away from the vehicle to prevent the key from interfering. After at least five minutes have elapsed, start the engine again. The new map data will be applied.

FIRMWARE AND SOFTWARE UPDATES

Software updates provide enhancements to the system, such as new features, added security, and upgraded functions. If you experience any issues or have questions related to updating your STARLINK[®] software, please contact your preferred Subaru Retailer.

For the 11.6-inch Multimedia Plus and the 11.6-inch Multimedia Navigation systems, system software can be updated via a Data Communication Module (DCM), if equipped. A STARLINK[®] Safety Plan subscription is also required. You will receive in-vehicle prompts and instructions on how to download and install the software update.

NOTE: System functionality will be restricted during installation, and you may need to reset radio station presets and volume settings after the update process.

To update the software via DCM:

1. Updated software will be downloaded automatically.
2. When the download is completed, a message asking if installation is desired or not will be displayed.
3. Select “Yes” to begin installation. Select “Remind Me Later” to delay installation.
4. When installation is complete, select “OK”.
5. Turn the ignition switch to the “LOCK” / “OFF” position and exit the vehicle.
6. Close the driver’s door and lock the doors, and then move at least 10 feet away from the vehicle to prevent the key from interfering.
7. After five minutes have elapsed, start the engine again, and the new software will be applied.

INDEX

2.4 L TURBO ENGINE 44

A

ACCESSORY CONNECTIONS 31
ADDING SHORTCUTS 55
ADVANCED ADAPTIVE CRUISE
CONTROL 16
AUDIO CONTROLS 14

B

BLIND SPOT DETECTION (BSD) / REAR
CROSS TRAFFIC ALERT (RCTA) . . 111
Blind Spot Detection (BSD) 111
Blind Spot Detection / Rear Cross
Traffic Alert OFF 113
Lane Change Assist (LCA) 112
Rear Cross Traffic Alert (RCTA) . . 112
BUTTONS 49
Controlling the Volume 49

C

CHILD SAFETY LOCKS 40
CLIMATE CONTROL 26
11.6-Inch Automatic Climate
Control 27
Dual 7-Inch Automatic Climate
Control 26
Heated Seats 30
Remote Engine Start with Climate
Control 30
CLOCK 97
COMBINATION METER 12
CREATING A DRIVER PROFILE 57
Retrieving a Driver Profile 60
CRUISE CONTROL 15

D

DRIVING THE VEHICLE 33
6-Speed Manual Transmission
(if equipped) 33

Drive Mode Select 35
Paddle Shift Control Switches
(if equipped) 34
SI-Drive 34
Subaru Performance Transmission . . 33

E

ELECTRONIC PARKING BRAKE
(EPB) 36
Auto Vehicle Hold (AVH)
(if equipped) 37
ENGINE OIL SPECIFICATIONS &
CAPACITIES 45
ENROLLMENT 92
EYESIGHT® DISCLAIMER 118
EYESIGHT® OVERVIEW 98
EYESIGHT® ASSIST MONITOR
(EAM) 108

F

FIRMWARE AND SOFTWARE
UPDATES 143
FLAT TIRE REPAIR KIT 43
FOLDING THE REAR SEATS 40
FUEL FILLER LID 39
FUEL SPECIFICATIONS AND
CAPACITY 39
FUNCTIONS 99
Advanced Adaptive Cruise Control
with Lane Centering 103
Automatic Emergency Steering . . . 101
Conventional Cruise Control 105
Lane Departure Prevention 103
Lane Departure Warning 102
Lane Sway Warning 102
Lead Vehicle Start Alert 106
Pre-Collision Brake Assist 101
Pre-Collision Braking 100
Pre-Collision Throttle Management . . 101

H

HIGH BEAM ASSIST (HBA)	114
HOME SCREEN ICONS	53
HOW TO OVERVIEW	119

I

IGNITION SWITCH	32
IMPORTANT SAFETY INFORMATION . . .	4
IN CASE OF EMERGENCY	5
Subaru Roadside Assistance	5
SUBARU STARLINK® Safety and Security (if equipped, subscription required)	5
INSTRUMENT PANEL SWITCHES	14
INTERNAL SAFETY TRUNK RELEASE WITH SELF-ILLUMINATING HANDLE	43
i SWITCH	17

K

KEYLESS ACCESS WITH PUSH BUTTON START	8
Locking Using Door Handles	8
Unlocking the Trunk	9
Unlocking Using Door Handles	8
KEYLESS ENTRY	7
Automatic Door Locking/Unlocking . .	7

L

LANE DEPARTURE WARNING AND PRE-COLLISION BRAKING SYSTEM OFF	109
Lane Departure Warning OFF	109
Pre-Collision Braking System OFF . .	110
LATCH/ANCHOR	41
LIGHT CONTROLS	18
Daytime Running Lights	19
Illumination Brightness	19

M

MAKING A CALL	84
MAPS	126
Arrival Distance / Time	140
Canceling Guidance	141
Creating Home/Work	126
Finding a Location with What3Words	131
Guidance Screen Icons	138
Map Updates	141
Map View/Perspectives	140
Map Zoom	139
Nearest Gas Station	140
Route Options	134
Route Preference	135
Saving Destination as a Favorite . .	136
Searching for a Destination	128
Traffic Information	140
MAPS/NAVIGATION	96
Checking for Map Updates	96
Updating Maps Using Your PC/MAC	97
Updating Over-the-Air	97
MAPS OVERVIEW	90
What3words	90
MEDIA	70
AUX Input	70
Bluetooth®	70
USB / iPod	70
MYSUBARU	88
Service Appointment Scheduler . . .	89
MYSUBARU INTEGRATION	92

N

NEW VEHICLE BREAK-IN	45
--------------------------------	----

O

OPERATION	99
OVERHEAD CONSOLE	21

INDEX

OVERVIEW OF YOUR MULTIMEDIA SYSTEM	48
Screen Layout	48
Various Systems	48
OWNER'S RESOURCES	4

REVERSE AUTOMATIC BRAKING (RAB)	115
Reverse Automatic Braking (RAB) OFF	115
ROOF MOLDING AND CROSSBAR	46

P

PAIRING AN ANDROID PHONE	72
Android Auto Best Practices	76
Android Auto Compatible Models and Cables	77
Bluetooth® Pairing and Android Auto	72
PAIRING AN iPhone	78
Apple CarPlay Best Practices	83
Bluetooth® Pairing and Apple CarPlay	78
iPhone Compatible Models and Cables	83
PAIRING A PHONE	71
PHONE	96
POWER EXTERIOR MIRRORS	24
POWER MOONROOF	25
Sliding the Moonroof	25
Tilting the Moonroof	25
POWER WINDOWS	25
PUSH-BUTTON IGNITION SWITCH	32

R

RADIO	64
AM/FM Radio	64
Presets	69
Satellite Radio	65
REARRANGING ICONS	54
REAR SEAT REMINDER	42
Passenger Occupant Detection and Seatbelt Reminders	42
REAR-VISION CAMERA	111
RECEIVING A CALL	85

S

SAFETY AND SECURITY OVERVIEW	91
SEATING	22
Head Restraint Adjustment	23
Manual Seats	22
Power Driver's Seat (if equipped)	22
Seatbelt Adjuster	23
SETTINGS AND UPDATES OVERVIEW	94
Connect to Home Wi-Fi (Navigation Models Only)	94
Performing Software Updates	94
SETTING THE CLOCK	119
Automatically	121
Manually	120
SOUND	95
STARTING THE VEHICLE	32
Without Push-button Ignition	32
With Push-button Ignition	32
STEERING RESPONSIVE HEADLIGHTS (SRH)	114
STEERING WHEEL CONTROLS	51
Advanced Adaptive Cruise Control	107
Customizing EyeSight® Settings	108
STEREO CAMERA PRECAUTIONS	116
SUBARU STARLINK® IN-VEHICLE APPS	87
Android Auto™	87
Apple CarPlay®	87
SiriusXM® Travel Link	88
SUBARU STARLINK® WI-FI HOTSPOT	93

T

TEXT MESSAGES	86
TILT AND TELESCOPIC STEERING	
COLUMN	24
TIRE PRESSURE MONITORING SYSTEM (TPMS)	46
TOUCHSCREEN	50
TOWING YOUR ALL-WHEEL DRIVE	
SUBARU	6
TRAILER TOWING CAPACITY	46
TURNING OFF THE VEHICLE	38
Without Push-button Ignition	38
With Push-button Ignition	38
TURN SIGNALS	20

V

VALET MODE	60
Activating Valet Mode	61
Deactivating Valet Mode	63
VOICE RECOGNITION	51
Common Commands	52
Tips	51

W

WARNING AND INDICATOR LIGHTS	13
WELCOME	4
WI-FI	123
Connecting to a Wi-Fi Network	123
Wi-Fi Hotspot Subscription (if equipped)	125
WINDSHIELD GLASS AND	
DASHBOARD	116
WINDSHIELD WIPERS	20
WRX	117

2.4 L TURBO ENGINE 44

A

ACCESSORY CONNECTIONS 31
 ADDING SHORTCUTS 55
 ADVANCED ADAPTIVE CRUISE CONTROL
 16
 AUDIO CONTROLS 14

B

BLIND SPOT DETECTION (BSD) / REAR
 CROSS TRAFFIC ALERT (RCTA) . . . 111
 Blind Spot Detection (BSD) 111
 Blind Spot Detection / Rear Cross Traffic
 Alert OFF 113
 Lane Change Assist (LCA) 112
 Rear Cross Traffic Alert (RCTA) . . . 112
 BUTTONS 49
 Controlling the Volume 49

C

CHILD SAFETY LOCKS 40
 CLIMATE CONTROL 26
 11.6-Inch Automatic Climate
 Control 27
 Dual 7-Inch Automatic Climate
 Control 26
 Heated Seats 30
 Remote Engine Start with Climate
 Control 30
 CLOCK 97
 COMBINATION METER 12
 CREATING A DRIVER PROFILE 57
 Retrieving a Driver Profile 60

CRUISE CONTROL 15

D

DRIVING THE VEHICLE 33
 6-Speed Manual Transmission (if
 equipped) 33
 Drive Mode Select 35
 Paddle Shift Control Switches (if
 equipped) 34
 SI-Drive 34
 Subaru Performance Transmission . . 33

E

ELECTRONIC PARKING BRAKE (EPB)
 36
 Auto Vehicle Hold (AVH) (if
 equipped) 37
 ENGINE OIL SPECIFICATIONS &
 CAPACITIES 45
 ENROLLMENT 92
 EYESIGHT® DISCLAIMER 118
 EYESIGHT® OVERVIEW 98
 EYESIGHT® ASSIST MONITOR (EAM)
 108

F

FIRMWARE AND SOFTWARE
 UPDATES 143
 FLAT TIRE REPAIR KIT 43
 FOLDING THE REAR SEATS 40
 FUEL FILLER LID 39
 FUEL SPECIFICATIONS AND
 CAPACITY 39
 FUNCTIONS 99
 Advanced Adaptive Cruise Control with
 Lane Centering 103
 Automatic Emergency Steering . . . 101
 Conventional Cruise Control 105
 Lane Departure Prevention 103
 Lane Departure Warning 102

INDEX

Lane Sway Warning	102
Lead Vehicle Start Alert	106
Pre-Collision Brake Assist	101
Pre-Collision Braking	100
Pre-Collision Throttle Management	101

H

HIGH BEAM ASSIST (HBA)	114
HOME SCREEN ICONS	53
HOW TO OVERVIEW	119

I

IGNITION SWITCH	32
IMPORTANT SAFETY INFORMATION	4
IN CASE OF EMERGENCY	5
Subaru Roadside Assistance	5
SUBARU STARLINK® Safety and Security (if equipped, subscription required)	5
INSTRUMENT PANEL SWITCHES	14
INTERNAL SAFETY TRUNK RELEASE WITH SELF-ILLUMINATING HANDLE	43
i SWITCH	17

K

KEYLESS ACCESS WITH PUSH BUTTON START	8
Locking Using Door Handles	8
Unlocking the Trunk	9
Unlocking Using Door Handles	8
KEYLESS ENTRY	7
Automatic Door Locking/Unlocking	7

L

LANE DEPARTURE WARNING AND PRE-COLLISION BRAKING SYSTEM OFF	109
Lane Departure Warning OFF	109

Pre-Collision Braking System OFF	110
LATCH/ANCHOR	41
LIGHT CONTROLS	18
Daytime Running Lights	19
Illumination Brightness	19

M

MAKING A CALL	84
MAPS	126
Arrival Distance / Time	140
Canceling Guidance	141
Creating Home/Work	126
Finding a Location with What3Words	131
Guidance Screen Icons	138
Map Updates	141
Map View/Perspectives	140
Map Zoom	139
Nearest Gas Station	140
Route Options	134
Route Preference	135
Saving Destination as a Favorite	136
Searching for a Destination	128
Traffic Information	140
MAPS/NAVIGATION	96
Checking for Map Updates	96
Updating Maps Using Your PC/MAC	97
Updating Over-the-Air	97
MAPS OVERVIEW	90
What3words	90
MEDIA	70
AUX Input	70
Bluetooth®	70
USB / iPod	70
MYSUBARU	88
Service Appointment Scheduler	89

MYSUBARU INTEGRATION 92

N

NEW VEHICLE BREAK-IN 45

O

OPERATION 99

OVERHEAD CONSOLE 21

OVERVIEW OF YOUR MULTIMEDIA

SYSTEM 48

Screen Layout 48

Various Systems 48

OWNER'S RESOURCES 4

P

PAIRING AN ANDROID PHONE 72

Android Auto Best Practices 76

Android Auto Compatible Models and

Cables 77

Bluetooth® Pairing and Android

Auto 72

PAIRING AN iPhone 78

Apple CarPlay Best Practices 83

Bluetooth® Pairing and Apple

CarPlay 78

iPhone Compatible Models and

Cables 83

PAIRING A PHONE 71

PHONE 96

POWER EXTERIOR MIRRORS 24

POWER MOONROOF 25

Sliding the Moonroof 25

Tilting the Moonroof 25

POWER WINDOWS 25

PUSH-BUTTON IGNITION SWITCH . . . 32

R

RADIO 64

AM/FM Radio 64

Presets 69

Satellite Radio 65

REARRANGING ICONS 54

REAR SEAT REMINDER 42

Passenger Occupant Detection and

Seatbelt Reminders 42

REAR-VISION CAMERA 111

RECEIVING A CALL 85

REVERSE AUTOMATIC BRAKING (RAB)

. 115

Reverse Automatic Braking (RAB)

OFF 115

ROOF MOLDING AND CROSSBAR . . . 46

S

SAFETY AND SECURITY OVERVIEW . . 91

SEATING 22

Head Restraint Adjustment 23

Manual Seats 22

Power Driver's Seat (if equipped) . . . 22

Seatbelt Adjuster 23

SETTINGS AND UPDATES OVERVIEW . . 94

Connect to Home Wi-Fi (Navigation

Models Only) 94

Performing Software Updates 94

SETTING THE CLOCK 119

Automatically 121

Manually 120

SOUND 95

STARTING THE VEHICLE 32

Without Push-button Ignition 32

With Push-button Ignition 32

STEERING RESPONSIVE HEADLIGHTS

(SRH) 114

STEERING WHEEL CONTROLS 51

Advanced Adaptive Cruise Control . . 107

Customizing EyeSight® Settings . . 108

STEREO CAMERA PRECAUTIONS . . 116

SUBARU STARLINK® IN-VEHICLE

APPS 87

Android Auto™ 87

Apple CarPlay® 87

SiriusXM® Travel Link 88

INDEX

SUBARU STARLINK® WI-FI HOTSPOT
..... 93

T

TEXT MESSAGES 86

TILT AND TELESCOPIC STEERING
COLUMN 24

TIRE PRESSURE MONITORING SYSTEM
(TPMS) 46

TOUCHSCREEN 50

TOWING YOUR ALL-WHEEL DRIVE
SUBARU 6

TRAILER TOWING CAPACITY 46

TURNING OFF THE VEHICLE 38
Without Push-button Ignition 38
With Push-button Ignition 38

TURN SIGNALS 20

V

VALET MODE 60

Activating Valet Mode 61

Deactivating Valet Mode 63

VOICE RECOGNITION 51

Common Commands 52

Tips 51

W

WARNING AND INDICATOR LIGHTS . . . 13

WELCOME 4

WI-FI 123

Connecting to a Wi-Fi Network . . . 123

Wi-Fi Hotspot Subscription (if
equipped) 125

WINDSHIELD GLASS AND

DASHBOARD 116

WINDSHIELD WIPERS 20

WRX 117

Subaru of America, Inc.
One Subaru Drive
Camden, NJ 08103-9800



MSA5B2405A
Issued December 2023
Printed in USA 12/23

