

Getting Started Guide

Outback

2024



Love. It's what makes Subaru, Subaru.



© 2023 Subaru of America, Inc. Printed in USA. All rights reserved. Contents may not be reproduced in whole or in part without prior written permission of publisher. Specifications in this Guide are based on the latest product information available at the time of publication. Some images shown are for illustration purposes only. Some equipment shown in photography within this Guide is optional at extra cost. Specific options may be available only in combination with other options. Specific combinations of equipment or features may vary from time to time, and by geographic area. Subaru of America, Inc. reserves the right to change or discontinue at any time, without notice: Prices, colors, materials, equipment, accessories, specifications, models, and packages, without incurring any obligation to make the same or similar changes on vehicles previously sold. Colors shown may vary due to reproduction and printing processes. Subaru of America, Inc. is not responsible for typographical errors.

Aha® is a registered trademark of Harman International Industries, Incorporated. Alcantara® is a registered trademark of Alcantara S.p.A., and Alcantara is produced by the Toray Group. App Store® is a registered trademark of Apple, Inc. Apple® is a registered trademark of Apple, Inc. Apple CarPlay® is a registered trademark of Apple, Inc. BBS® is a registered trademark of BBS Kraftfahrzeugtechnik, AG. Bluetooth® is a registered trademark of Bluetooth SIG, Inc. BRIN NAUB® is a registered trademark of TB Kawashima Co., Ltd. Brembo® is a registered trademark of Freni Brembo, S.p.A. Clari-Fi® is a registered trademark of Harman International Industries, Incorporated. Glympse® is a registered trademark of Glympse, Inc. Google, Android, Android Auto, and Google Play are trademarks of Google LLC. Grand Luxe® is a registered trademark of Seiren Co., Ltd. GreenEdge® is a registered trademark of Harman International Industries, Incorporated. HARMAN® is a registered trademark of HARMAN International Industries, Incorporated. Harman Kardon® is a registered trademark of Harman International Industries, Incorporated. Quantum logic™ is a trademark of Harman International Industries, Incorporated. HD Radio® is a registered trademark of iBiquity Digital Corporation. HomeLink® and the HomeLink® house icon are registered trademarks of Gentex Corporation. iHeartRadio® is a registered trademark of iHeartMedia, Inc. iPod® is a registered trademark of Apple, Inc. iTunes® is a registered trademark of Apple, Inc. Michelin® is a registered trademark of Compagnie Générale des Etablissements Michelin. Metal-Matrix Diaphragm (MMD®) is a registered trademark of Harman International Industries, Incorporated. MirrorLink™ is a trademark of Car Connectivity Consortium, LLC. Pandora® is a registered trademark of Pandora Media, Inc. Qi® is a registered trademark of Wireless Power Consortium, Inc. QR Code is a registered trademark of Denso Wave Incorporated. Subaru Solterra Connect™ is a trademark of Subaru Corporation. SACHS® is a registered trademark of ZF Friedrichshafen AG. Siri® is a registered trademark of Apple, Inc. Smart Way® is a registered trademark of the U.S. Environmental Protection Agency. Stitcher™ is a trademark of Stitcher™, Inc. TomTom® is a registered trademark of TomTom International BV. TORSEN LSD® is a registered trademark of JTEKT TORSEN North America, Inc. SiriusXM all related logos are trademarks of Sirius XM Radio Inc. and its respective subsidiaries. Other marks, channel names and logos are the property of their respective owners. All rights reserved. Ultrasuede® is a registered trademark of Toray Industries, Inc. WHAT3WORDS® is a registered trademark of WHAT3WORDS Ltd. Yelp® is a registered trademark of Yelp, Inc. Ascent, Added Security, DriverFocus, Crosstrek, Forester, Outback, StarTex and StarDrive are registered trademarks of Subaru of America, Inc. Subaru Wilderness™ logo is a trademark of Subaru Corporation. BRZ, EyeSight, Impreza, Lineartronic, Legacy, S209, Solterra, Subaru, SUBARU STARLINK, Starlink, SUBARU BOXER, tS (Design), WRX, STI, X-MODE and Wilderness are registered trademarks of Subaru Corporation.

TABLE OF CONTENTS



PURPOSE OF THIS GUIDE

WELCOME	4
IMPORTANT SAFETY INFORMATION	4
OWNER'S RESOURCES	4
IN CASE OF EMERGENCY	5
TOWING YOUR ALL-WHEEL DRIVE SUBARU	6

ENTRY AND EXIT

KEYLESS ENTRY	7
KEYLESS ACCESS WITH PUSH BUTTON START	8
POWER REAR GATE (PRG)	10

INSTRUMENT PANEL

GAUGES AND WARNING LIGHTS

COMBINATION METER	16
WARNING AND INDICATOR LIGHTS	17

CONTROLS

INSTRUMENT PANEL SWITCHES (LOWER LEFT)	18
AUDIO CONTROLS	18
ADVANCED ADAPTIVE CRUISE CONTROL	19
i SWITCH	19
LIGHT CONTROLS	20

TURN SIGNALS	21
--------------------	----

WINDSHIELD WIPERS	21
-------------------------	----

REAR WINDOW WIPER	22
-------------------------	----

OVERHEAD CONSOLE	23
------------------------	----

GETTING COMFORTABLE

SEATING	24
---------------	----

TILT AND TELESCOPIC STEERING COLUMN	27
---	----

POWER EXTERIOR MIRRORS ..	27
---------------------------	----

REAR VIEW MIRROR	29
------------------------	----

POWER WINDOWS	31
---------------------	----

CENTER CONSOLE STORAGE ..	31
---------------------------	----

POWER MOONROOF	32
----------------------	----

CLIMATE CONTROL	33
-----------------------	----

ACCESSORY CONNECTIONS ..	39
--------------------------	----

OPERATING THE VEHICLE

IGNITION SWITCH	40
-----------------------	----

PUSH-BUTTON IGNITION SWITCH	40
-----------------------------------	----

STARTING THE VEHICLE	40
----------------------------	----

DRIVING THE VEHICLE	41
---------------------------	----

AUTO START-STOP	42
-----------------------	----

ELECTRONIC PARKING BRAKE (EPB)	44
--------------------------------------	----

X-MODE®	46
---------------	----

TURNING OFF THE VEHICLE ..	49
----------------------------	----

TABLE OF CONTENTS

REFUELING	
FUEL FILLER LID	50
FUEL SPECIFICATIONS AND CAPACITY	50
PASSENGER/CARGO AREAS	
FOLDING THE REAR SEATS	51
CHILD SAFETY LOCKS	52
LATCH/ANCHOR	52
REAR SEAT REMINDER	53
CARGO COVER	54
SPARE TIRE	55
ENGINE COMPARTMENT	
HOOD PROP.	56
2.5L ENGINE	57
2.4L TURBO ENGINE	58
ADDITIONAL SPECIFICATIONS	
NEW VEHICLE BREAK-IN.	59
ENGINE OIL SPECIFICATIONS & CAPACITIES	59
ROOF RAIL / CROSS BAR CAPACITY	60
TRAILER TOWING CAPACITY	60
TIRE PRESSURE MONITORING SYSTEM (TPMS)	61
STARLINK OVERVIEW	
OVERVIEW OF YOUR MULTIMEDIA SYSTEM	63
BUTTONS	65
TOUCHSCREEN	66
STEERING WHEEL CONTROLS.	67
VOICE RECOGNITION	67
STARLINK HOME	
HOME SCREEN ICONS	69
REARRANGING ICONS	70
ADDING SHORTCUTS	70
DRIVER PROFILE	
CREATING A DRIVER PROFILE	72
VALET MODE	75
MULTIMEDIA	
RADIO	80
MEDIA	82
PHONE	
PAIRING A PHONE	83
PAIRING AN ANDROID PHONE	84
PAIRING AN IPHONE	91
MAKING A CALL	97
RECEIVING A CALL	98
TEXT MESSAGES	99
APPS	
SUBARU STARLINK® IN-VEHICLE APPS	100
MYSUBARU	101
MAPS (if equipped)	
MAPS OVERVIEW	103
STARLINK SAFETY AND SECURITY	
SAFETY AND SECURITY OVERVIEW	104
ENROLLMENT	105
MYSUBARU INTEGRATION	105
SUBARU STARLINK® WI-FI HOTSPOT	106
SETTINGS AND UPDATES	
SETTINGS AND UPDATES OVERVIEW	107
SOUND	108
PHONE	109
MAPS/NAVIGATION	109
CLOCK	111
EYESIGHT	
EYESIGHT® OVERVIEW	112
OPERATION	113
FUNCTIONS	113
STEERING WHEEL CONTROLS	119
EYESIGHT® ASSIST MONITOR (EAM)	121
LANE DEPARTURE WARNING AND PRE-COLLISION BRAKING SYSTEM OFF	122
DRIVER ASSIST TECHNOLOGIES	
REAR-VISION CAMERA	124
FRONT VIEW MONITOR	125
BLIND SPOT DETECTION (BSD) / REAR CROSS TRAFFIC ALERT (RCTA)	126

TABLE OF CONTENTS

HIGH BEAM ASSIST (HBA) . . .	128
STEERING RESPONSIVE HEADLIGHTS (SRH)	128
REVERSE AUTOMATIC BRAKING (RAB)	129

DRIVERFOCUS DISTRACTION MITIGATION SYSTEM

(if equipped)

DRIVERFOCUS® OVERVIEW . .	130
DRIVERFOCUS® COMPONENTS	130
DROWSY/INATTENTIVE WARNINGS	132
DRIVER PROFILE/CONVENIENCE SETTINGS	132
DRIVER MONITORING SYSTEM OFF	134

CARE AND LIMITATIONS

STEREO CAMERA PRECAUTIONS	135
WINDSHIELD GLASS AND DASHBOARD	135

FRONT VIEW

OUTBACK	136
-------------------	-----

EYESIGHT DISCLAIMER

EYESIGHT® DISCLAIMER	137
------------------------------	-----

HOW TO APPENDIX

HOW TO OVERVIEW	138
SETTING THE CLOCK	138
MEMORY HEIGHT	143
MEMORY DRIVER'S SEAT	145
WI-FI	147
MAPS	150

INDEX	167
------------------------	-----

PURPOSE OF THIS GUIDE

WELCOME

Congratulations on choosing a Subaru Outback and welcome to the Subaru family!

Subaru is more than a car company™. We are committed to making the world a better place, and the Subaru Love Promise is our vision to show love and respect to all people at every interaction with Subaru. We believe in building lifelong relationships with our customers, earning your trust and exceeding your expectations by providing customer service with integrity and compassion.

This Getting Started Guide will introduce you to your new Subaru Outback by providing information on the basic operation and key features of your Subaru as well as the STARLINK® and EyeSight® systems in your vehicle.

IMPORTANT SAFETY INFORMATION

The Getting Started Guide is not intended as a substitute for your Owner's Manuals. We strongly encourage you to review your Vehicle, STARLINK®, and EyeSight® Owner's Manuals to ensure complete understanding.

As part of routine maintenance and continuous improvement, Subaru releases updates to the firmware and software in your vehicle. Following the installation of these updates, the screens and menus in your vehicle may differ from what appears in this guide.

 For the most current information on firmware and software updates, please refer to the "Owner's Resources" in the following section or contact your Subaru Retailer.

OWNER'S RESOURCES

If you're having difficulty using any of the functions outlined in this guide, or want to learn more, you can get additional information from the following sources:

Your Subaru Owner's Manuals:

Located in the glovebox

Online Subaru Owner's Resources:

www.subaru.com/owners

Subaru Customer Support:

www.subaru.com/customer-support

1-800-782-2783 (1-800-SUBARU3)



Scan to learn more about Owner's Resources.



Scan to learn more about Customer Support.



Scan to get the **MySubaru** App.

PURPOSE OF THIS GUIDE

IN CASE OF EMERGENCY

SUBARU STARLINK® Safety and Security (if equipped, subscription required)

SOS Emergency: Press the red “SOS” button on the overhead console in the event of an emergency to speak with a SUBARU STARLINK® Customer Care Advisor.

Enhanced Roadside Assistance:

Press the blue “i” button on the overhead console or select the “MySubaru” button and then choose “Roadside Assistance” on the multimedia system. The “i” button also connects to the Concierge service, if subscribed.



SOS and Roadside Assistance Buttons

i For more information, please refer to “Safety and Security

Overview” on page 104 in this Getting Started Guide or “Introduction” in your SUBARU STARLINK® Safety and Security Owner’s Manual. Not available in all states. See Retailer for details.

Subaru Roadside Assistance

Subaru Roadside Assistance:

1-800-261-2155

Subaru Roadside Assistance is free and standard on your Subaru; there are no forms to complete. This service is available anytime during the 3-year/36,000-mile Subaru Limited Warranty, whichever comes first. See your Subaru Retailer for details and refer to the Roadside Assistance guide in the owner’s information kit for the details on this coverage. A Subaru Roadside Assistance decal has been affixed to the driver’s door window.

Roadside assistance helps with:

- Towing to the nearest authorized Subaru Retailer if you cannot safely drive your Subaru
- Jump-start if your battery is dead
- Gasoline delivery if you run out of gas
- Flat tire change to install your spare
- Emergency lockout service
- National Subaru Retailer locator service, with phone numbers and location of the nearest Subaru Retailer anywhere in the U.S. or Canada

NOTE: Specifically excluded from Subaru Roadside Assistance coverage are service requests or claims resulting from: accidents, vandalism, acts of God, violation of any laws, or vehicle modifications not recommended by the manufacturer.

PURPOSE OF THIS GUIDE

TOWING YOUR ALL-WHEEL DRIVE SUBARU

Since Subaru Symmetrical All-Wheel Drive distributes power to all four wheels, improper towing may damage your AWD system. The best way to tow your Outback is with a flatbed truck by your Subaru Retailer or a commercial towing service.

 For more information, please refer to “In Case of Emergency” in your Owner’s Manual.

KEYLESS ENTRY

1 Lock/Arm

- Press the lock/arm button to lock the doors, the rear gate, and the fuel filler lid and to activate the security alarm. A chirp sounds and the hazard warning lights flash once.
- If any of the doors or the rear gate are not fully closed, five rapid chirps sound and the hazard warning lights flash to alert you.
- Press the lock/arm button three times to activate the vehicle finder function. If you are within 30 feet of your Subaru, the horn sounds once, and the hazard warning lights flash three times.

2 Unlock/Disarm

- Press the unlock/disarm button once to unlock the driver's door and fuel filler lid. Two chirps sound and the hazard warning lights flash twice. To unlock all the doors and the rear gate, briefly press the button twice.
- The interior lights will illuminate when you press the unlock/disarm button if the interior light switch is set to the "DOOR" position on the overhead console.

3 Rear Gate

- Press the rear gate button to unlock the rear gate.
- If your Subaru has a Power Rear Gate, press and hold this button to open or close the rear gate.

4 Panic Alarm

- Press the panic alarm button to sound the horn and flash the hazard warning lights.
- Press any button on the access key fob or transmitter to deactivate the panic alarm.



Transmitter



Access Key Fob

Automatic Door Locking/Unlocking

This feature allows you to set when your Subaru automatically locks or unlocks the doors through the STARLINK® Touchscreen (select "Settings", and then select the "Car" menu). The available settings are listed in the table below.

		AVAILABLE SETTINGS			
AUTO DOOR LOCK/UNLOCK	AUTO DOOR LOCK	Vehicle Speed (12 mph)	Shift into or out of PARK	OFF	
	AUTO DOOR UNLOCK	Ignition OFF	Driver Door Open	Shift into or out of PARK	OFF

ENTRY AND EXIT

KEYLESS ACCESS WITH PUSH BUTTON START

(if equipped)

The Keyless Access with Push-Button Start system features the following touch-activated door locking or unlocking functions without the key ever leaving your pocket or purse. You can customize the touch-activated door locking or unlocking settings using the STARLINK[®] Touchscreen by selecting “Settings,” and then selecting the “Car” menu.

Unlocking Using Door Handles

Grip the driver’s door handle to unlock the driver’s door and fuel filler lid. Grip the front passenger’s door handle to unlock all doors, the fuel filler lid, and the rear gate. Two chirps sound and the hazard warning lights flash twice.

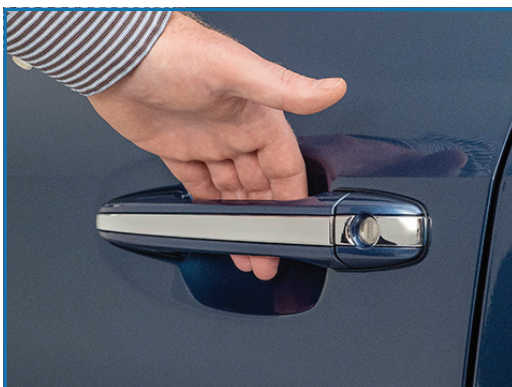

Door Unlock Sensor

Locking Using Door Handles

Close all the doors and the rear gate and touch the door lock sensor (two lines) on either front door handle. All doors and the rear gate lock. One chirp sounds and the hazard warning lights flash once.



Door Lock Sensor

Unlocking Using the Rear Gate

Press the rear gate opener button to unlock and open the rear gate. Two chirps sound and the hazard warning lights flash twice.



Rear Gate Opener Button

Locking Using the Rear Gate

Close all the doors and the rear gate and press the rear lock button. All doors and the rear gate lock. One chirp sounds and the hazard warning lights flash once.



Rear Lock Button

ENTRY AND EXIT

POWER REAR GATE (PRG) (if equipped)

The Power Rear Gate allows automatic opening, even when your arms are full, and a single touch of a button can close the gate and lock the entire vehicle. The opening height can also be adjusted for spaces where clearance is limited.

 You can learn more about the Power Rear Gate from the video linked in the QR code and “Keys and Doors” in your Owner’s Manual.



Scan to learn more about the Power Rear Gate.

Power Rear Gate Button

Opening the Power Rear Gate

Press and hold the Power Rear Gate Button on the instrument panel to automatically open the rear gate. Two chirps sound and the hazard warning lights flash twice.

Stopping the Power Rear Gate

If you briefly press the Power Rear Gate Button while the rear gate is opening, it will stop. Press and briefly hold the button again to close the rear gate.

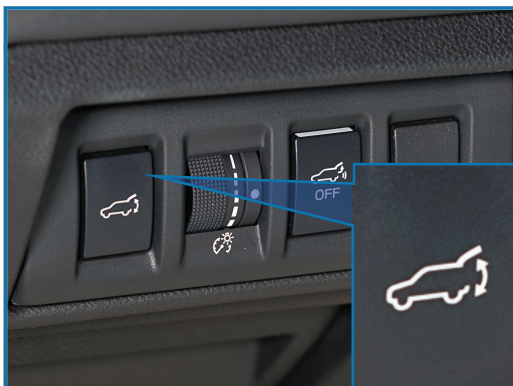

Power Rear Gate Button

Closing the Power Rear Gate

Press and hold the Power Rear Gate Button on the instrument panel to close the rear gate. If you briefly press the button while the rear gate is closing, it will open.

The operation of the Power Rear Gate is the same using the Power Rear Gate Button on the access key fob or transmitter.

NOTE: If the doors are locked when you operate the Power Rear Gate, you may hear three rapid beeps from the vehicle. In this case, unlock the doors and then operate the Power Rear Gate.

From the Rear of the Vehicle

Opening the Power Rear Gate

To open the rear gate, briefly press the Rear Gate Opener Button on the underside trim near the license plate, and the rear gate automatically opens.



Rear Gate Opener Button

Stopping the Power Rear Gate

If you briefly press the Power Rear Gate Close Button on the inside edge of the rear gate while the gate is opening, it will stop. Press the button again to close the rear gate.

Closing the Power Rear Gate

To close the rear gate, briefly press the Power Rear Gate Close Button on the inside edge of the rear gate. If you press the button while the gate is closing, it will open.



Power Rear Gate Close Button

ENTRY AND EXIT

Power Rear Gate Lock

Press the lock button on the inside edge of the rear gate. The Power Rear Gate will close, and all doors, the rear gate, and the fuel filler lid will lock.



Power Rear Gate Close and Lock Button

Hands-free Power Rear Gate

The Hands-free Power Rear Gate allows automatic opening even when your arms are full. Using the Subaru emblem, you can open the rear gate without even touching your Outback.

The Hands-free function operates when the ignition is OFF and you are carrying the access key fob. To open the Power Rear Gate with the Hands-free function:

1. Hold your hand or arm over the Subaru emblem on the rear gate, without touching it, until a chirp sounds.
2. Immediately after the chirp sounds, move your hand away.
3. The rear gate opens automatically.



ENTRY AND EXIT

The Hands-free Power Rear Gate function can be turned ON/OFF by pressing the Hands-free Power Rear Gate OFF button on the instrument panel. It may be helpful to turn this function off when washing your Outback or attaching a trailer or carrier.



Hands-free Power Rear Gate Off Button

i The Power Rear Gate also comes equipped with a memory height function, allowing you to set where the Power Rear Gate stops when it opens. For step by step instructions on setting the memory height, please refer to the how-to video linked in the QR code and to page 143 in this Getting Started Guide.



Scan to learn
how to set
**Power Rear Gate
Memory Height.**

INSTRUMENT PANEL

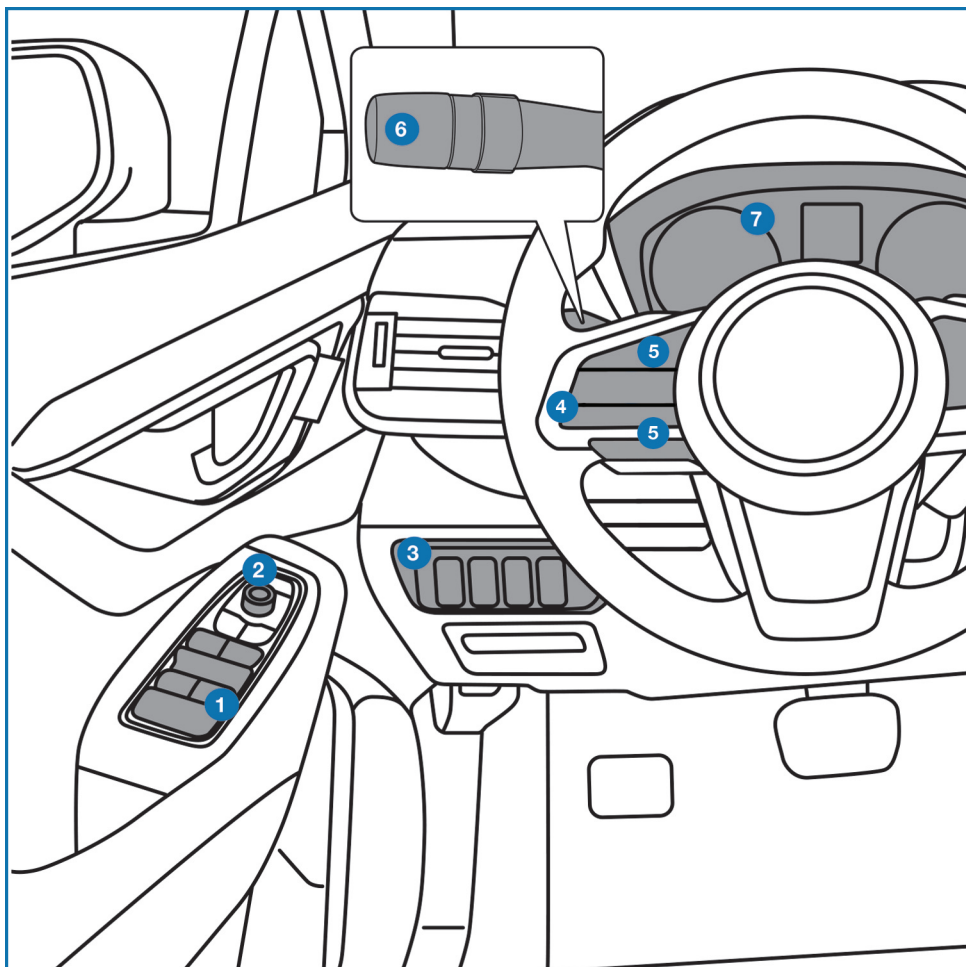

- ① Power Windows (p. 31)
- ② Power Exterior Mirrors (p. 27)
- ③ Instrument Panel Switches (p. 18)
- ④ I Switch (p. 19)
- ⑤ Audio Controls (p. 18)
- ⑥ Light Controls (p. 20)
- ⑦ Combination Meter (p. 16)

INSTRUMENT PANEL

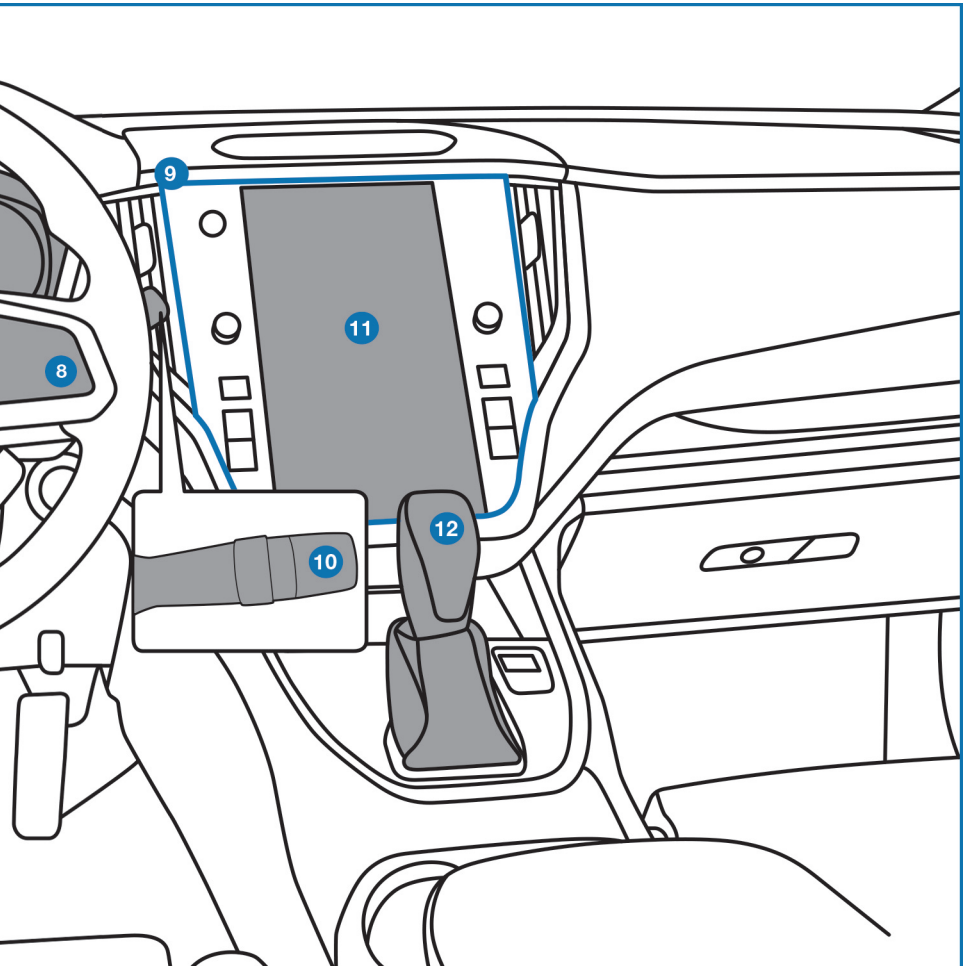

- ⑧ Advanced Adaptive Cruise Control (p. 19)
- ⑨ Center Information Display (CID) (p. 63)
- ⑩ Windshield Wipers (p. 21)
- ⑪ SUBARU STARLINK® Multimedia Touchscreen (p. 64)
- ⑫ CVT Select Lever (p. 41)

GAUGES AND WARNING LIGHTS

COMBINATION METER

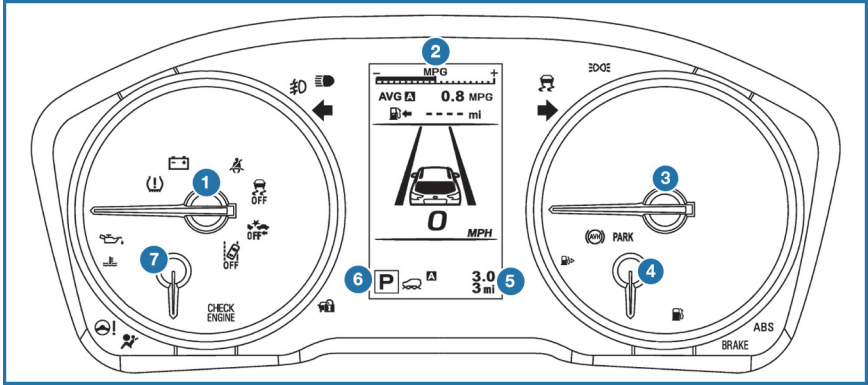



- 1** Tachometer
- 2** Combination Meter Display (CMD)
- 3** Speedometer
- 4** Fuel gauge
- 5** Trip meter and odometer
- 6** Select lever/gear position indicator
- 7** Engine coolant temperature gauge



GAUGES AND WARNING LIGHTS

WARNING AND INDICATOR LIGHTS

Red lights indicate immediate attention is required. Some examples are:

		BRAKE / (!)
Seatbelt warning	Door open indicator	Brake system warning

Yellow lights indicate caution. Some examples are:

		
Low fuel	Engine low oil level warning	Tire pressure warning

Green and **blue** lights are for information. Some examples are:

		
Headlight indicator	Auto Vehicle Hold	High beam indicator

CONTROLS

INSTRUMENT PANEL SWITCHES (LOWER LEFT)

The switches in the lower left of the instrument panel allow you to control convenient features. The switches include:

- 1 Power Rear Gate (p. 10)
- 2 Illumination Brightness (p. 20)
- 3 Hands-free Power Rear Gate OFF (p. 12)

For more information, please refer to “Keys and Doors” and “Instruments and Controls” in your Owner’s Manual.



AUDIO CONTROLS

- 1 Source
- 2 Presets/Skip
- 3 Info Switch
- 4 Arrow Switches
- 5 Call and End/Mute Switches
- 6 Talk Switch
- 7 Volume Switches

For more information about your audio system and controls, please refer to page 67 in this Getting Started Guide or “Quick Guide” in your STARLINK® Owner’s Manual.



ADVANCED ADAPTIVE CRUISE CONTROL

- 1 Adaptive Cruise Control On/Off
- 2 Lane Centering
- 3 Increase Distance
- 4 Decrease Distance
- 5 Resume (RES)/Increase Speed and Set (SET)/Decrease Speed

i For more information on the Advanced Adaptive Cruise Control switches, please refer to page 119 in this Getting Started Guide or “Advanced Adaptive Cruise Control” in your EyeSight® Owner’s Manual.



i SWITCH

The “i” switch and arrows allow you to cycle through useful driving information in the Combination Meter Display (CMD) such as fuel consumption, driving time, speed, and tire pressure, among others. You can change the information displayed by using the up and down arrows.

If there are some useful messages, such as vehicle information or warning screens, they will interrupt the current screen, and appear on the display, accompanied by a beep. If such a screen is displayed, take proper action according to the message shown on the screen. The warning screen will return to the original screen after a few seconds. Important vehicle information or warning screens may be able to be displayed when the “i” appears in the CMD. Press the “i” switch to access the important messages.

i For more information about the Combination Meter Display, please refer to “Instruments and Controls” in your Owner’s Manual.



CONTROLS

LIGHT CONTROLS



- 1 AUTO:** Rotate the end of the lever to set your headlights to automatically turn on or off, depending on the level of light outside. When in the “AUTO” position, the headlights will automatically turn on when the windshield wipers operate several times.

NOTE: The sensitivity of the automatic headlights can be adjusted through the STARLINK® multimedia display.

- 2 Parking Lights:** Rotate the end of the lever to turn on the instrument panel illumination, parking lights, side marker lights, tail lights, and license plate lights.
- 3 Headlights:** Rotate the end of the lever to turn on the headlights, instrument panel illumination, parking lights, side marker lights, tail lights, and license plate lights. To flash the headlights, pull the lever toward you, and then release. The high beams will stay on as long as you hold the lever. The headlight flasher works even with the headlight control switch in the off position.
- 4 High Beams:** Push the lever forward to change from low beam to high beam. When set to the “AUTO” position, pushing the lever forward also activates the High Beam Assist (HBA) system. Pull the lever back to center to return to low beam.
- 5 Fog Lights:** If equipped, rotate the dial to turn on the fog lights when the headlights are on low beams in the “” or “AUTO” position.



Illumination Brightness

When the light controls are on (in the “”, “”, or “AUTO” position), and ambient light is low, rotating the illumination brightness dial on the instrument panel upward will make the instrument panel illumination brighter. When the dial is fully rotated upward (dots aligned), the instrument panel illumination stays at full brightness. Rotating the dial downward dims the instrument panel illumination.



Illumination Brightness Dial

When the ambient light is bright, the illumination brightness is set to the maximum regardless of the position of the control dial.

- 1 For more information, please refer to “Instruments and Controls” in your Owner’s Manual.

Daytime Running Lights

The daytime running lights automatically turn on when the engine is running, the parking brake is fully released, the select lever is out of the “P” position, and the light switch is set to Off, “AUTO”, or “ DRL ”. Always turn on the headlights when it’s dark outside by rotating the dial to the “ D ” or “AUTO” position.

TURN SIGNALS

Push fully up for the right turn signal and fully down for the left turn signal. Your Subaru also has a one-touch lane changer feature: push slightly up and release to signal a right lane change or push slightly down and release to signal a left lane change.



WINDSHIELD WIPERS

- 1 **Intermittent:** Push the wiper control lever down one position for intermittent operation. When the lever is in the intermittent position, you can rotate the dial to adjust the operating interval of the wipers.
- 2 **Low Speed:** Push the wiper control lever down two positions for low speed wiper operation.
- 3 **High Speed:** Push the wiper control lever down three positions for high speed wiper operation.
- 4 **Mist:** Push the wiper up from the off position for a single wipe.
- 5 **Windshield Washer:** Pull the lever toward you to wash the windshield. The washer will spray and the wipers will operate while you pull the lever.



CONTROLS

REAR WINDOW WIPER

Rotate the end of the lever up one position for intermittent, or two positions for continuous operation.

When the lever is in the intermittent position, the wiper operates at intervals corresponding with vehicle speed. When you move the select lever to the “R” position, the wiper will switch to continuous operation. It will return to intermittent operation when you move the select lever out of “R”.

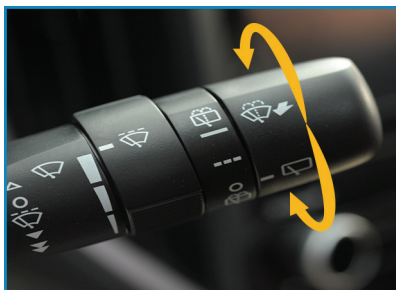

Rotate the dial up from the continuous operation position or down from the off position to spray washer fluid. The washer sprays and wiper operates until you release the dial, and then returns to the previous position.

Rear-vision Camera Washer

To help keep your vision clear, your Subaru comes equipped with a Rear-vision Camera Washer. To clean the Rear-vision Camera, simply use the rear window washer, and a stream of washer fluid will aid in cleaning the camera.

 For more information about the Rear-vision Camera and Rear-vision Camera Washer, please refer to page 124 in this Getting Started Guide or “Instruments and Controls” in your Owner’s Manual.



OVERHEAD CONSOLE

- 1 SOS Emergency Assistance (if equipped):** Press the red “SOS” button to connect with a SUBARU STARLINK® Customer Care Advisor (Subscription required). Press and hold the button for about two seconds to cancel the call.

i For more information, please refer to page 104 in this Getting Started Guide or “Introduction” in your SUBARU STARLINK® Safety and Security Owner’s Manual.

- 2 Enhanced Roadside Assistance (if equipped):** Press the blue “i” button to connect with a SUBARU STARLINK® Roadside Assistance Provider (Subscription required). Press and hold the button for about two seconds to cancel the call. The “i” button is also used for Concierge services, if subscribed.

i For more information, please refer to page 104 in this Getting Started Guide or “Introduction” in your SUBARU STARLINK® Safety and Security Owner’s Manual.

- 3 Automatic Illumination:** When the interior light switch is set to the “DOOR” position, the lights will automatically turn on and off depending on the locking and unlocking of the doors, the opening and closing of the doors, as well as the position of the ignition switch.

- 4 Power Moonroof Switch (if equipped):** Use this switch to operate the power moonroof.

i For more information, please refer to page 32 in this Getting Started Guide or “Keys and Doors” in your Owner’s Manual.

- 5 Map Lights:** Press a map light to turn it on or off.

NOTE: The map lights can remain on even when the ignition is off, key removed from vehicle and doors are locked.



GETTING COMFORTABLE

SEATING

Manual Seats

- 1 Forward/Backward:** Pull the lever below the seat up and slide the seat forward or backward. Release the lever and make sure the seat is locked into place.
- 2 Seat Height (Driver's Seat):** Pulling up or pushing down on the lever will raise or lower the seat cushion.
- 3 Recline Seatback:** Pull the lever up to adjust the seatback. Release the lever and make sure the seatback is locked into place.



Manual Seat Levers

GETTING COMFORTABLE

Power Driver's Seat (if equipped)

- 1 Seat Position:** Moving the switch forward or backward will adjust the seat in that direction. Pulling up or pushing down on the back of the switch will adjust the seat height up or down. Pulling up or pushing down on the front of the switch will adjust the angle of the seat cushion.
- 2 Recline Seatback:** Moving the top of the switch forward or backward will adjust the angle of the seatback.
- 3 Lumbar Support:** Press the front side of the switch to increase lower back support. Press the rear side of the switch to decrease support. If equipped, press the upper or lower side of the switch to adjust the lumbar support height.
- 4 Thigh Extension (if equipped):** Pull up on the lever below the seat cushion to adjust the length.



Power Seat Controls



Thigh Extension

- 1** If equipped, your Subaru can be programmed to automatically recall your preferred Power Driver's Seat and exterior mirror positions. For step by step instructions on setting the Power Memory Seat, please refer to page 145 in this Getting Started Guide.



Memory Seat Buttons

GETTING COMFORTABLE

Head Restraint Adjustment

Pull the head restraint up to raise it. To lower the head restraint, push it down while pressing the release button on the top of the seatback. Each head restraint should be adjusted so that the center of the head restraint is closest to the top of the occupant's ears.

The angle of the front head restraints can be adjusted by tilting them forward. You will hear a click when the restraint locks in place. Pulling the head restraint as far forward as it will go allows it to return to the fully upright position.

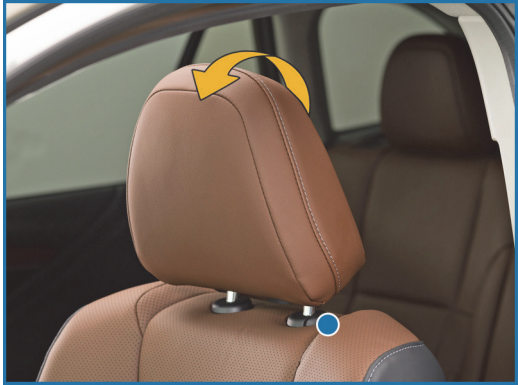

Release Button and Head Restraint Adjustment

Seatbelt Adjuster

To keep yourself comfortable and safe, always position the seatbelt adjuster so the shoulder belt passes over the middle of your shoulder without touching your neck. Press and hold the top of the adjuster and slide it up or down. Release the adjuster and make sure it is locked in place.



Seatbelt Adjustment Tab

GETTING COMFORTABLE

TILT AND TELESCOPIC STEERING COLUMN

You can adjust both the height and lengthwise position of the steering wheel. Pull the lever on the steering column down firmly to unlock, and then adjust the position of the steering wheel. Push the lever firmly back up to lock the steering wheel in place.



Steering Column Unlock

POWER EXTERIOR MIRRORS

The power mirror knob works with the ignition in the “ON” or “ACC” position. Turn the knob to “L” (left side) or “R” (right side) to select a mirror. Push the knob in the direction you want to move the mirror. Turn the knob back to the center position when finished.



Power Mirror Knob

GETTING COMFORTABLE

Power Folding Mirrors (if equipped)

The Power Folding Mirrors make it easy to protect your exterior mirrors when your Subaru is parked or being washed in an automated car wash. Press the switch to fold the exterior mirrors and press again to unfold. The switch works with the ignition in the "ON" or "ACC" positions.

NOTE: Always ensure the mirrors are unfolded before driving.



Power Folding Mirror Switch

If equipped, the power folding mirrors can also be set to automatically fold in and out. On the Center Information Display, select "Settings", then "Car". Select "Door Mirror Setting" to turn on or off the Auto Electric Folding function.

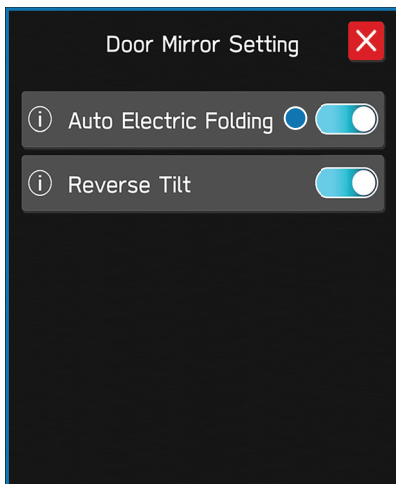

GETTING COMFORTABLE

Reverse Tilt Mirror (if equipped)

The passenger side mirror can be set to automatically tilt down when you move the select lever to the "R" position, giving better visibility when backing up. The mirror returns to its normal position a few seconds after you move the select lever out of the "R" position. This setting can also be turned on or off in "Door Mirror Setting" in the Center Information Display.



REAR VIEW MIRROR

Auto-dimming Mirror (if equipped)

The auto-dimming function senses distracting glare during nighttime driving and automatically dims to eliminate the glare and preserve your vision. Press the switch to turn auto-dimming on or off. A green LED indicator illuminates when the function is on.



GETTING COMFORTABLE

HomeLink® 5 Accessory Mirror (if equipped)

The HomeLink® 5 accessory mirror provides three buttons to replace devices such as garage door openers, gate openers, entry door locks, security systems, and home lighting. The “Instruments and Controls” chapter in your Owner’s Manual provides programming instructions, and www.subaru.com/homelink has a helpful “how to” video.



Scan to learn more about HomeLink®.

NOTE: HomeLink® 5 may not be compatible with some older door openers or additional equipment may be required.

Smart Rearview Mirror (if equipped)

The smart rearview mirror has two available modes: mirror mode is used as an ordinary mirror, and display mode is used for displaying a video image from the rear view camera. Pull the mode lever toward you to use display mode, showing the image from the camera mounted on the shark fin antenna. This mode is convenient if passengers or cargo in your Outback obscure your view in the mirror or when there is poor rear visibility in the evening or nighttime. Push the mode lever away from you to use the ordinary mirror mode, which also functions as an anti-dazzle mirror to help preserve your vision.



GETTING COMFORTABLE

POWER WINDOWS

To open or close a window, partially press down or pull up and hold the corresponding switch. The front windows have a one-touch auto up/down function, and the rear windows may also have auto up/down function, if equipped. Fully press down or pull up and release to automatically open or close a one-touch window.



Power Window Switches

CENTER CONSOLE STORAGE

The center console has two sections consisting of an upper tray, convenient for safely storing an iPod, cellphone, or other small quick-access items, and a larger storage compartment beneath. Use the button on the driver's side to access the upper tray and the button on the passenger side (with dotted surface) to access the lower compartment.



GETTING COMFORTABLE

POWER MOONROOF (if equipped)

With the ignition in the “ON” position, you can tilt or slide the moonroof.

Tilting the Moonroof

- 1 With the moonroof in the fully closed position, press, briefly hold, and then release the center of the moonroof switch to automatically tilt the moonroof up. Slide and hold the moonroof switch forward to lay the moonroof back down.



Opening/Closing the Moonroof

- 2 **Opening:** Slide the switch rearward, briefly hold, and then release to automatically open the moonroof. It will stop slightly before the fully-open position to reduce wind noise. Slide the switch rearward again to fully open it.
- 3 **Closing:** Slide the switch forward, briefly hold, and then release to automatically close the moonroof.

Sliding the switch either way while the moonroof automatically opens or closes will pause the moonroof.

CLIMATE CONTROL

Dual 7-Inch Automatic Climate Control

The climate control buttons appear on the lower portion of the bottom display and are similar to the 11.6 inch display.



- 1 Climate Control On/Off Button
- 2 Climate Control Mode Indicator

- 3 Customizable Icon
- 4 Fan Speed Controls



Select the Climate Control Mode Indicator to display and adjust the airflow mode, Auto mode, air inlet selection, A/C, and Max A/C controls. Temperature can be adjusted using the red and blue arrow buttons on the side of the Center Information Display.

GETTING COMFORTABLE

11.6-Inch Automatic Climate Control



The climate control system is equipped with convenient and customizable features. In automatic control mode, set your desired temperature and let the system make the adjustments for you. At any time, you can manually take control of the climate settings. You can also set separate temperatures for the driver and front passenger.

- 1 Climate Control On/Off Button:** This button turns the climate control on and off.
- 2 Temperature Control Buttons:** Push the red arrow button to increase the temperature or the blue arrow button to decrease the temperature. The temperature appears on the screen. You can also adjust the setting via touchscreen by selecting the climate control mode indicator and using the arrows or sliding the temperature control bar. You can set separate temperatures for the driver's side and passenger's side.
- 3 Rear Window Defogger Button:** Press this button to turn on the rear window defogger. If equipped, the outside mirror defogger and windshield wiper deicer will also activate. It will automatically turn off after about 15 minutes. If the window clears before then, press the button again to turn it off. You can customize this function for continuous operation through the STARLINK® touchscreen by selecting "Settings", then "Car".
- 4 Defroster Button:** Press the defroster button to defrost or dehumidify the windshield and front door windows.





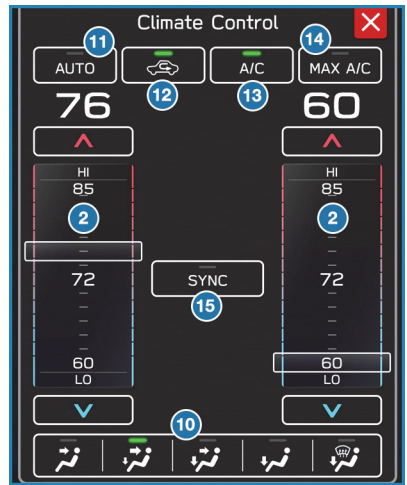

NOTE: When the defrost mode is selected, the air conditioning operates to defrost the windshield more quickly. However, the indicator on the air conditioner button may not illuminate.

GETTING COMFORTABLE

- 5 Customizable Button:** This button can be customized to be one of a number of buttons: A/C, Max A/C, Auto, Recirculation, or SYNC. On the Home Screen, select "Settings", "General", and then "Climate Control" to customize.
- 6 Fan Speed Control:** Select your preferred fan speed by using the fan speed arrow buttons on the climate control screen.
- 7 Heated Seat Button (if equipped):** Select this button to turn on the driver/passenger heated seat. Each time you press the button, the mode will change as follows: High, Mid, Low, Off. Yellow indicators illuminate indicating the level.
- 8 Ventilated Seat Button (if equipped):** Select this button to turn on the driver/passenger ventilated seat. Each time you press the switch, the mode will change as follows: High, Mid, Low, Off. Blue indicators illuminate indicating the level.
- 9 Climate Control Mode Indicator:** Select the Climate Control Mode Indicator to control the air flow mode, temperature, SYNC, A/C, Max A/C, Auto mode, and recirculation.
- 10 Airflow Mode Selection Buttons:** Press the button to select the desired airflow mode. The selected mode air flow mode is shown on the display.



GETTING COMFORTABLE

ICON	MODE	FUNCTION
	Ventilation	Instrument panel outlets
	Ventilation 2	Instrument panel outlets and less foot outlets than bi-level
	Bi-Level	Instrument panel outlets and foot outlets
	Feet	Foot outlets, both side outlets of the instrument panel and some through windshield defroster outlets
	Feet-Defrost	Windshield defroster outlets, foot outlets and both side outlets of the instrument panel
	Defrost	Windshield defroster outlets and both side outlets of the instrument panel

NOTE: The defroster button is used to activate the defrost airflow mode.

- 11 AUTO:** Select this button to activate automatic climate control operation. Set your preferred temperature, and the system will automatically control fan speed, airflow mode, air inlet selection, and air conditioner operation.
- 12 Air Inlet Selection Button:** Select this button to activate recirculation mode and recirculate the interior air inside the vehicle. Recirculation mode is helpful when driving on a dusty road or when you want cooling performance to increase. Select the button again to return to outside air circulation mode and allow outside air to be drawn into your Subaru.
NOTE: To prevent windshield fogging, do not remain in the recirculated mode for an extended period of time.
- 13 A/C:** Select this button to activate or deactivate the air conditioning.
- 14 MAX A/C Button:** Select this button for quickest cooling.
- 15 SYNC Button:** Select this button to synchronize the driver's and passenger's temperatures to the driver's temperature control. Select the SYNC button again or operate the passenger side temperature controls to cancel SYNC mode and adjust each side individually.

GETTING COMFORTABLE

Operation in Automatic Mode

When using automatic mode, the fan speed, airflow mode, air-inlet control and air conditioning operation are controlled automatically. To activate:

1. Select the climate control mode indicator, and then select the "AUTO" button.
2. Set your preferred temperature.

If you operate the fan speed control or the airflow mode, press the defroster button, or turn on Max A/C mode, the AUTO indicator will turn off and you can then manually control the system as desired. To change the system back to auto mode, select the "AUTO" button again.

Remote Engine Start with Climate Control (if equipped)



This feature can also be set through **MySubaru.com** or the **MySubaru App**



MySubaru App



MySubaru.com

You can remotely start your Subaru and adjust the temperature using the STARLINK® Safety and Security features through the **MySubaru App** (subscription required). Please refer to "SUBARU STARLINK Features" in your SUBARU STARLINK® Safety and Security Owner's Manual for a list of required vehicle conditions for this feature.

Heated Seats (if equipped)



There are separate buttons for the driver and passenger heated seats. Select the heated seat button located on the climate control screen. Each time you press the button the mode will change as follows: High, Mid, Low, and Off. The indicators illuminate indicating the level.

GETTING COMFORTABLE

Ventilated Seats (if equipped)



There are separate buttons for the driver and passenger ventilated seats. Select the ventilated seat button located on the climate control screen. Each time you press the button the mode will change as follows: High, Mid, Low, and Off. The indicators illuminate indicating the level.

Rear Heated Seats (if equipped)

There are separate heated seat switches for each side on the rear center console. Press the switch to activate the heated seat. The heating mode changes to High, Low, and Off each time you press the switch, and yellow indicators illuminate indicating the level.



Heated Steering Wheel (if equipped)

To activate, pull the heated steering wheel switch with the ignition in "ON" or "ACC". The indicator light on the switch illuminates. To deactivate, pull the switch again. The heater will stay on for approximately 30 minutes.

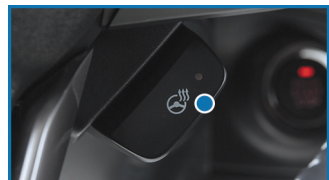

ACCESSORY CONNECTIONS

- 1 Auxiliary Input Jack:** The 3.5mm auxiliary input jack is located below the Center Information Display. You can connect a portable music player to the auxiliary jack and hear the music stored on it through your Subaru's speakers. Press the "Source" button located on the steering wheel or the "Media" button on the Touchscreen to select the auxiliary mode.



Connection Ports

i For more information,

please refer to page 82 in this Getting Started Guide or "Audio" in your STARLINK® Owner's Manual.

- 2 USB-C Port:** If equipped, USB-C charge ports are located below the Center Information Display and on the rear center console. The USB-C ports provide charging (DC 5 V / 3.0 A) to devices.
- 3 USB-A Port:** A USB-A port is located below the Center Information Display and, if equipped, on the rear center console. You can connect a variety of USB-equipped devices to the front port, such as portable music players or smartphones, to enjoy your favorite music or connect to Apple CarPlay® or Android Auto™. The USB-A port(s) provide charging (DC 5 V / 2.4 A) to devices. The port on the rear center console is for charging only.

i For more information, please refer to page 82 in this Getting Started Guide or "Audio" in your STARLINK® Owner's Manual.

i For more information and step-by-step set up instructions for Android Auto™ and Apple CarPlay®, please refer to the How To Appendix in this Getting Started Guide on page 84 for Android Auto™ and on page 91 for Apple CarPlay®.

Power Outlets:

Power outlets (12 V DC) are located in the glove box, cargo area, and, if equipped, the center console. Electrical power is available for use with in-vehicle electrical appliances with a maximum power rating of 120 W.

i For more information, please refer to "Interior Equipment" in your Owner's Manual.

OPERATING THE VEHICLE

IGNITION SWITCH

The ignition switch has four positions:

LOCK: You can only insert or remove the key in this position.

ACC (Accessory): Provides power to the audio system and accessory power outlets.

ON: All electrical systems are available. The key returns to this position after starting the engine.

START: Turn the key to this position to start the engine.

PUSH-BUTTON IGNITION SWITCH (if equipped)

Each time you press the ignition switch without depressing the brake pedal, the ignition position will change as follows: ACC, ON, OFF.

ACC (Accessory): Provides power to the audio system and accessory power outlets. Orange indicator illuminates.

ON: All electrical systems are available. Orange indicator illuminates.

OFF: Power off and indicator off.

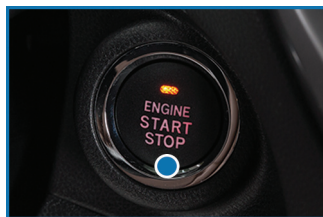

STARTING THE VEHICLE

Without Push-button Ignition

To start the engine:

1. Make sure the select lever is in the “P” position.
2. Using the key, turn the ignition switch to “START”.

NOTE: Do not depress the accelerator pedal. Release the key as soon as the engine starts.

With Push-button Ignition

To start the engine:

1. Sit in the driver's seat with the access key fob.
2. Make sure the select lever is in the “P” position.
3. Depress the brake pedal.
4. When the Engine START/STOP button indicator turns green, briefly press and release the Engine START/STOP button.

DRIVING THE VEHICLE

Automatic Transmission Shift Mode

The Continuously Variable Transmission (CVT) is electronically controlled and provides two different driving modes: normal and manual.

Normal Mode

When the select lever is in the “D” (Drive) position, the transmission is in normal shift mode. The select lever position indicator in the Combination Meter Display (CMD) shows “D” and the transmission automatically shifts into a suitable forward gear.

Manual Mode

In manual mode, you select the desired gear position to obtain necessary acceleration and engine braking. Move the select lever left from the “D” position into the “M” position to select manual mode. The gear position indicator in the Combination Meter Display (CMD) shows the currently selected gear. Arrow-shaped indicators show when upshifting or downshifting is available. To shift gears, use the paddle shift control switches behind the steering wheel.



Paddle Shift Control Switches

You can shift gears using the paddle shift control switches. To upshift to the next higher gear, pull the “+” paddle on the right toward you. To downshift to the next lower gear, pull the “-” paddle on the left toward you.

You can temporarily shift gears even when the select lever is in the “D” position by pulling either the “+” or “-” paddle toward you. Once vehicle speed stabilizes, the transmission will switch back to normal mode.



OPERATING THE VEHICLE

AUTO START-STOP

The Auto Start-Stop system is designed to automatically stop and restart the engine when the vehicle is stationary for a short period of time (while waiting for a traffic light or in a traffic jam) after the engine has warmed up. The system operates in order to reduce fuel consumption, exhaust emissions and undesired idling noise. You can learn more about using the Auto Start-Stop system from the how-to video linked in the QR code and from the sections below.



Scan to learn more about Auto Start-Stop.

Auto Start-Stop System ON/OFF

The Auto Start-Stop system can be turned on and off in the Center Information Display (CID) by using the Auto Start-Stop button on the Home screen.

NOTE: The system will default to ON after the vehicle has been shut off.



When the Auto Start-Stop system is turned OFF, the Auto Start-Stop OFF indicator light in the combination meter display will illuminate. This is a solid yellow indicator.



System Operation

So that it can be used safely and comfortably, in addition to driver operations, the Auto Start-Stop system is designed to constantly monitor the vehicle conditions as well as the environment inside and outside the vehicle, in order to control stopping and restarting of the engine.

OPERATING THE VEHICLE

After the vehicle has been completely stopped by depressing the brake pedal with the select lever in the “D” position, the engine will be automatically stopped. When you release the brake pedal with the select lever kept in the “D” position, the engine will be automatically restarted.

If the engine is temporarily stopped by the system, the Auto Start-Stop indicator light on the combination meter will illuminate in green. This indicator light will turn off when the system restarts the engine.



Auto Vehicle Hold (AVH) also integrates seamlessly with Auto Start-Stop functions. With AVH activated, your Subaru is held in place once you have stopped the vehicle, so you can sit without your foot on the brake pedal. To restart the engine, just gently press down on the accelerator pedal.

There are several operating conditions for this system to operate as intended. Please refer to “Starting and Operating” in your Owner’s Manual for further information.

Auto Start-Stop Screen

Approximate indications of the time that the engine has been stopped by the Auto Start-Stop System and the amount of fuel saved can be displayed on the Combination Meter Display using the arrow switches. The values are calculated from the most recent reset of the currently displayed trip meter.

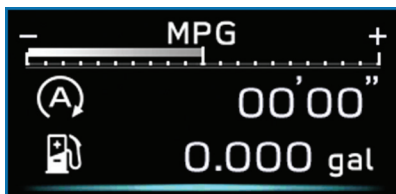

No Activity Detected Indicator Light

If the operational conditions are not met when the vehicle is stopped, the engine will not stop and the Auto Start-Stop No Activity Detected indicator light will illuminate. This indicator is solid white when illuminated. It will turn off when the vehicle begins to drive.







Auto Start-Stop Warning Light

The Auto Start-Stop warning light will illuminate in yellow when initially turning the ignition switch to the “ON” position. The light will turn off after the engine has started.



NOTE: If the Auto Start-Stop warning light does not turn off or is flashing yellow after the engine has started, the Auto Start-Stop system may be malfunctioning. We recommend that you contact your authorized SUBARU Retailer for an inspection.

OPERATING THE VEHICLE

INDICATOR	PATTERN	CONDITION
	Solid green	This indicator light illuminates when the engine has been temporarily stopped by the Auto Start-Stop system. It will turn off when the engine is restarted.
	Solid White	Operational conditions have not been met, the engine will not stop and this light will illuminate. The light goes out once the brake pedal is released.
	Solid Yellow	This light indicates that the system has been turned off. The light will turn off once the system is turned back on.
	Solid/Flashing Yellow	A fault has been detected with the Start-Stop system. Please contact your authorized Subaru Retailer.

ELECTRONIC PARKING BRAKE (EPB)

To apply the parking brake, depress the brake pedal and pull the parking brake switch up. The indicator light on the parking brake switch will illuminate and "PARK" will appear in the Combination Meter.

To release the parking brake manually, depress the brake pedal and push the parking brake switch down with the ignition in the "ON" position. To automatically release the parking brake, gently press the accelerator pedal.



NOTE: Automatic parking brake release will not work unless all the doors are closed and your seatbelt is fastened.

OPERATING THE VEHICLE

Auto Vehicle Hold (AVH)

Auto Vehicle Hold gives your feet a break by automatically holding your Subaru in place when it is at a complete stop, such as at a traffic signal, even after you release the brake pedal. The function works when the select lever is not in the “P” position.

To turn the function on, simply select the Auto Vehicle Hold button on the home screen in the Center Information Display. When the AVH function is on, the Auto Vehicle Hold indicator illuminates in the Combination Meter Display. Once you bring your Subaru to a complete stop by depressing the brake pedal, the function operates to keep your Subaru in place.

While your Subaru is being held by this function, the Auto Vehicle Hold indicator flashes. Depress the accelerator pedal or brake pedal to release the Auto Vehicle Hold function. Select the Auto Vehicle Hold button on the home screen again to turn AVH off.

NOTE:

- For this system to work, your driver's door must be closed, and your seatbelt must be fastened.
- **Make sure to turn off this function before entering an automatic car wash.**



ICON	
	
Illuminated Auto Vehicle Hold ON	Flashing Auto Vehicle Hold IN OPERATION

OPERATING THE VEHICLE

X-MODE®

X-MODE® is the integrated control system of the engine, All Wheel Drive, and Vehicle Dynamics Control (VDC) systems for driving with bad road conditions. Using X-MODE®, you can drive more comfortably even in slippery road conditions, such as mud or snow, including uphill and downhill.

You can activate the system when the vehicle speed is less than 12 mph. Display the Driving Statistics Screen (select the Car Info button on the home screen) to show steering angle, running condition, and vehicle posture. If the vehicle speed reaches 25 mph while X-MODE® is active, the system is cancelled.

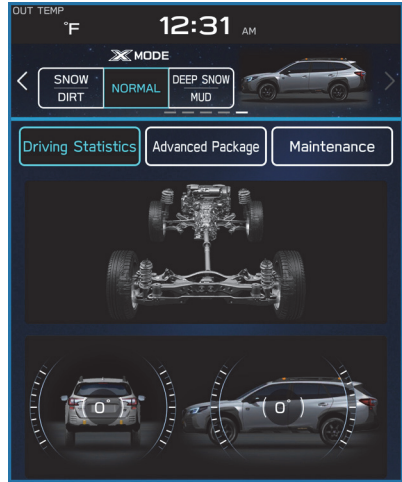

The X-MODE® Indicator appears in the Combination Meter Display when X-MODE® is activated.



X-Mode Indicator

OPERATING THE VEHICLE

Activating X-MODE®

X-MODE® can be quickly turned on or off in the Information Bar. Use the arrow button to navigate to X-MODE® and select the setting.

You can also turn X-MODE® on or off in the Vehicle Control Menu, giving you access to other important vehicle functions as well:

- 1 Select the “Car Settings” icon.
- 2 In the “Vehicle Control” menu, select “X-MODE®” to turn the function on or off.

In certain situations, such as navigating a vehicle stuck in mud or snow, it may be helpful to allow more wheel spin by turning off the Vehicle Dynamics Control system:

- 3 In the “Vehicle Control” menu, select “Vehicle Dynamics Control OFF”.

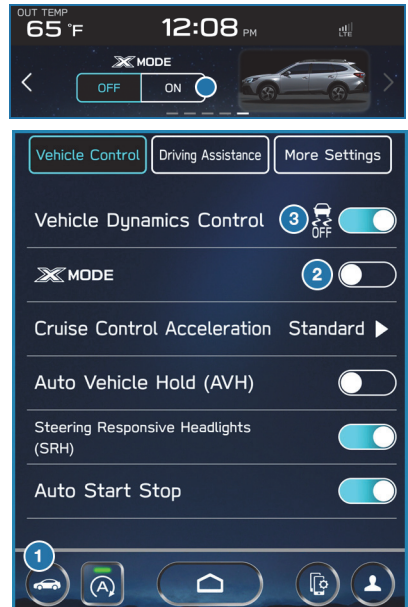

OPERATING THE VEHICLE

X-MODE® Dual Mode System

For vehicles with an X-MODE® Dual Mode System, select NORMAL, SNOW/DIRT or DEEP SNOW/MUD:

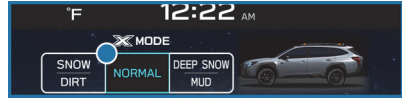

- SNOW/DIRT is suitable for driving on slippery road surfaces such as snow or gravel, where the points of contact between the tires and road surface are visible.



Snow/Dirt Indicator

- DEEP SNOW/MUD provides maximum torque from the engine and the optimal amount of slip in the driving wheels, enabling the vehicle to free itself more effectively. It is suitable for driving on a roads where the tires can become buried, such as deep snow, dry sand, or muddy roads.

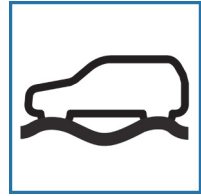

Deep Snow/Mud Indicator

Outback Wilderness

Outback Wilderness includes expanded functionality of the DEEP SNOW/MUD setting, with operation above 25 mph. This enhanced functionality automatically activates above 25 mph and returns to DEEP SNOW/MUD below 25 mph without any extra inputs needed, allowing you to focus on vehicle control.

Hill Descent Control (HDC)

The Hill Descent Control function helps maintain a consistent vehicle speed when driving down steep hills or declines. HDC is automatically activated and set in standby mode when X-MODE® is activated. The Hill Descent Control Indicator appears when in standby mode, and the indicator will flash when HDC is operating.

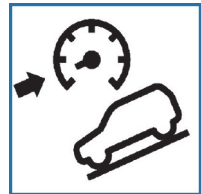

Hill Descent Control Indicator

TURNING OFF THE VEHICLE

Without Push-button Ignition

To stop the engine:

1. Stop your Subaru completely.
2. Move the select lever to the “P” position.
3. Turn the ignition switch to LOCK/OFF.

NOTE: Windows equipped with a one-touch auto up/down function will remain active for about 40 seconds or until a front door is opened, whichever occurs first.

With Push-button Ignition

To stop the engine:

1. Stop your Subaru completely.
2. Move the select lever to the “P” position.
3. Press the ignition switch to stop the engine.

NOTE: Windows equipped with a one-touch auto up/down function will remain active for about 40 seconds or until a front door is opened, whichever occurs first.

REFUELING

FUEL FILLER LID

The fuel filler lid is located toward the rear of the passenger side. To open the lid:

1. Make sure your Subaru is stopped and the select lever is placed in the “P” position. Then, turn the ignition to the off position.
2. The fuel filler lid is unlocked by using the unlock switch in the door, access key fob, or door handles.
3. Push the rear side of the lid.
4. When the lid opens slightly, open it further by hand.

While refueling, place the fuel filler cap on the cap holder inside the lid.

After refueling, put the cap back on and turn it clockwise until you hear a clicking noise. Be certain not to catch the tether under the cap while tightening.

To close the lid, press it until you hear it latch.

NOTE: The Check Engine warning light may illuminate if the fuel filler cap is not tightened properly.



Fuel Filler Lid and Cap

FUEL SPECIFICATIONS AND CAPACITY

2.5L Engine Fuel Specifications and Capacity

Fuel Octane Rating	87 AKI or higher
Ethanol Content Limit	No more than 10%
Fuel Tank Capacity	18.5 US Gallons
Low Fuel Warning Light	2.6 US Gallons

2.4L Engine Fuel Specifications and Capacity

Fuel Octane Rating	87 AKI or higher
Ethanol Content Limit	No more than 15%
Fuel Tank Capacity	18.5 US Gallons
Low Fuel Warning Light	2.6 US Gallons

PASSENGER/CARGO AREAS

FOLDING THE REAR SEATS

The rear seats can be folded down from the back seat or from the cargo area.

First, lower the headrests. Then, push the release button until you see the red marker around the button and fold down the seats. To return the seatback to its original position, raise the seatback until it locks into place. You will no longer be able to see the red marker when the seat is locked.

Release latches are located on either side of the cargo area. Pull the release latch on the seat side that you want to fold down.

You can also recline the rear seats by pulling up on the lever on the side of the seat and pushing back.

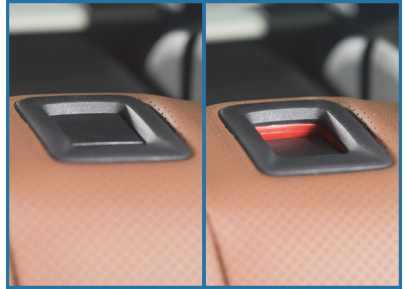

PASSENGER/CARGO AREAS

CHILD SAFETY LOCKS

The child safety locks are located on the inside edges of the rear doors. In the locked position, the rear doors can only be opened from the outside.



LATCH/ANCHOR

Your Subaru is equipped with Lower Anchors and Tethers for Children (LATCH). For maximum safety, first carefully read the LATCH system instructions from the device manufacturer, as well as the installation instructions in your Owner's Manual, to properly install the LATCH compatible restraint system. Use the appropriate seatbelts or anchorages provided in your Subaru. Children age 12 and under must properly occupy the rear seat at all times.

 For more information, please refer to "Seat, Seatbelt and SRS Airbags" in your Owner's Manual.

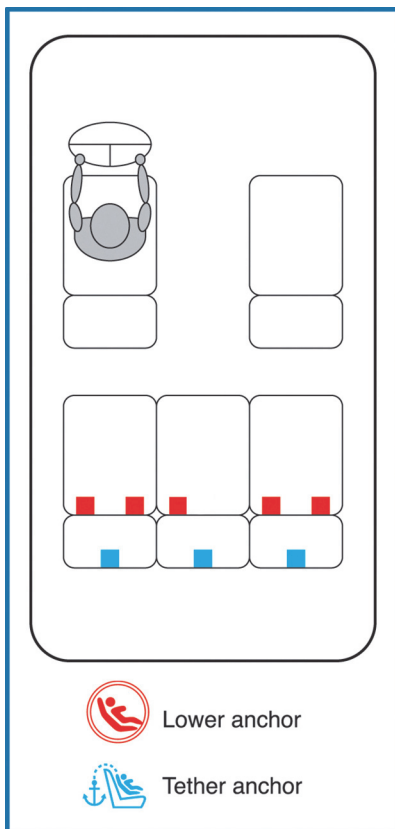

PASSENGER/CARGO AREAS

REAR SEAT REMINDER

The Rear Seat Reminder system assists you in preventing a child or pet from being left in your Subaru, prompting you to confirm the presence of passengers and cargo in the rear seats. The system monitors the opening and closing of the rear doors. It does not physically sense the presence of a child or pet.

The system activates when the rear doors are opened and closed. When the ignition switch is turned from the "ON" position to the "OFF" position, the system warns you with audible beeps and with a "Reminder, Look in Rear Seat" message in the Combination Meter Display (CMD).

You can turn the Rear Seat Reminder off in the Center Information Display (CID).



Passenger Occupant Detection and Seatbelt Reminders

To help keep your passengers safe, your Subaru has a passenger occupant detection and seatbelt reminder system for each seat, including the rear seats.

If passengers in the rear seats do not fasten their seatbelts while the ignition is in the "ON" position, the seatbelt warning lights illuminate and blink for the specific seat, and a warning chime may sound.



 For more information, please refer to "Instruments and Controls" in your Owner's Manual.

PASSENGER/CARGO AREAS

CARGO COVER (if equipped)

The cargo cover is provided to cover the cargo area and to protect its contents from direct sunlight. It has an easy lift-up function, eliminating the need to rewind the cover all the way when accessing the cargo. The cover can also be detached to make room for additional cargo. Hold the cover by the handle in the center, tilt it up and pull it out to extend the cover. Then insert the stoppers into the catches.



Cargo Cover Extended

To lift the cover to access cargo, pull down the handle in the center to release the stoppers from the catches, and allow the stoppers to slide up the grooves.



Cargo Cover Raised

Store the cover under the floor of the cargo area when not in use.



Cargo Cover Stowed

PASSENGER/CARGO AREAS

SPARE TIRE

The maintenance tools and spare tire are stored in the under-floor storage compartment. Hang the hook provided on the underside of the cargo area floor lid on the rear edge of the roof to keep the lid open. Outback Onyx XT and Wilderness come equipped with a full size spare tire.



Your vehicle is equipped with the following maintenance tools.

- Jack
- Jack handle
- Screwdriver
- Towing hook (eye bolt)
- Wheel nut wrench
- Torque wrench for roof rails (if equipped)

NOTE: The temporary spare tire, if equipped, must be used only on a rear wheel. If a front wheel tire gets punctured, replace the wheel with a rear wheel and install the temporary spare tire in place of the removed rear wheel.



 For more information, please refer to “In Case of Emergency” in your Owner’s Manual.

ENGINE COMPARTMENT

HOOD PROP

The hood prop is located on the left underside of the hood. Release it from the retainer and insert the end into the slot in the engine compartment.

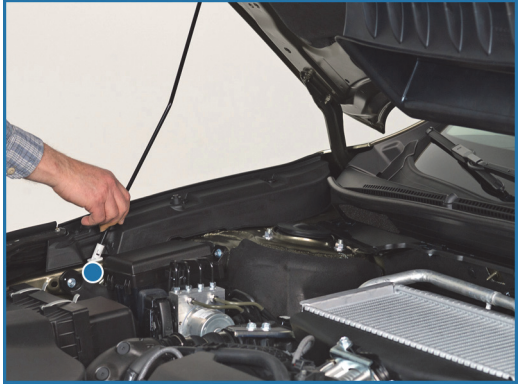

ENGINE COMPARTMENT

2.5L ENGINE

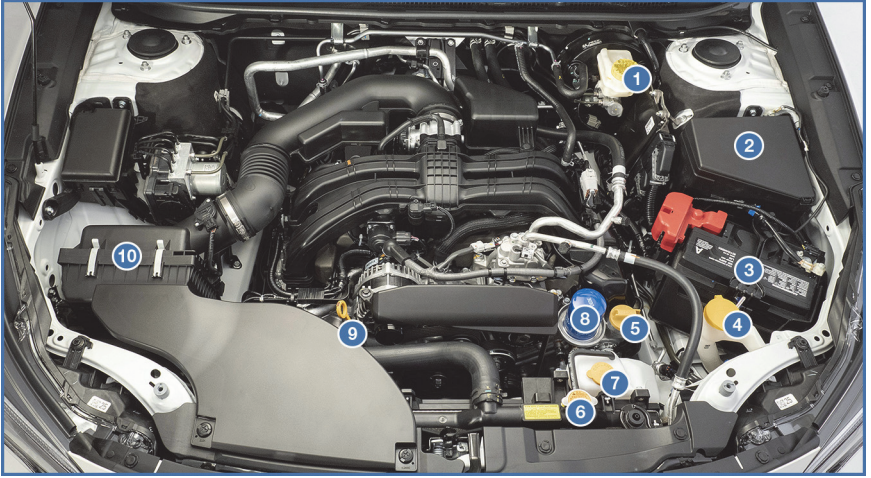

- 1 Brake Fluid Reservoir
- 2 Fuse Box
- 3 Battery
- 4 Windshield Washer Tank
- 5 Engine Oil Filler Cap
- 6 Radiator Cap
- 7 Engine Coolant Reservoir
- 8 Engine Oil Filter
- 9 Engine Oil Dipstick
- 10 Air Cleaner Element

1 The following table lists recommended first service items. Your maintenance needs may vary depending on your driving conditions. Please consult with your retailer and refer to the Warranty and Maintenance Booklet for complete information and recommended replacement intervals.

Maintenance Item	Maintenance Interval	
	6 months or 6,000 Miles	12 months or 12,000 Miles
Replace Engine Oil and Filter	•	•
Rotate and Inspect Tires	•	•
Replace HVAC System A/C filter		•
Inspect Brake System, Steering System, and Suspension Components		•

ENGINE COMPARTMENT

2.4L TURBO ENGINE



- 1 Brake Fluid Reservoir
- 2 Fuse Box
- 3 Battery
- 4 Windshield Washer Tank
- 5 Engine Oil Filler Cap
- 6 Radiator Cap
- 7 Engine Coolant Reservoir
- 8 Engine Oil Filter
- 9 Engine Oil Dipstick
- 10 Air Cleaner Element

1 The following table lists recommended first service items. Your maintenance needs may vary depending on your driving conditions. Please consult with your retailer and refer to the Warranty and Maintenance Booklet for complete information and recommended replacement intervals.

Maintenance Item	Maintenance Interval	
	6 months or 6,000 Miles	12 months or 12,000 Miles
Replace Engine Oil and Filter	•	•
Rotate and Inspect Tires	•	•
Replace HVAC System A/C filter		•
Inspect Brake System, Steering System, and Suspension Components		•

ADDITIONAL SPECIFICATIONS

NEW VEHICLE BREAK-IN

The performance and long life of your Subaru are dependent on how you handle and care for your Subaru while it is new.

Follow these instructions during the first 1,000 miles:

- Do not race the engine.
- Do not allow the engine speed to exceed 4,000 rpm except in an emergency.
- Do not drive at one consistent engine or vehicle speed for a long time, either fast or slow.
- Avoid starting suddenly and rapid acceleration, except in an emergency.
- Avoid hard braking, except in an emergency.

ENGINE OIL SPECIFICATIONS & CAPACITIES

Only use 0W-20 Synthetic Engine Oil, with one of the following specifications:

Engine	Capacity (during oil and filter change)
2.5L Model	4.4 US quarts
2.4L Model	4.8 US quarts

When the level is at the "low" mark, add approximately 1.1 quarts of engine oil in through the filler cap to bring the oil level to the "full" mark. For filler cap location see the engine compartment on page 57 or page 58.

- 1 Full Level
- 2 Low Level

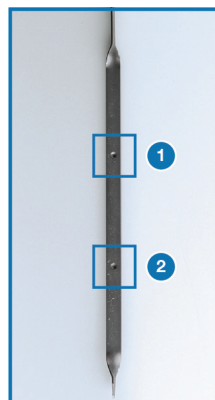

ADDITIONAL SPECIFICATIONS

ROOF RAIL / CROSS BAR CAPACITY

	Cross Bars Dynamic (if equipped)	Roof Rails Dynamic	Roof Rails Static	Rope Hooks
Outback (Except Wilderness)	150 Pounds	176 Pounds	176 Pounds	—
Outback (Wilderness)	150 Pounds	220 Pounds	700 Pounds	176 Pounds

 For more information, please refer to “Driving Tips” in your Owner’s Manual.

TRAILER TOWING CAPACITY

2.5L Models	
Maximum total trailer weight*	Maximum tongue weight*
2,700 pounds	270 pounds

2.4L Models	
Maximum total trailer weight*	Maximum tongue weight*
3,500 pounds	350 pounds

*Towing a trailer with brakes.

NOTE:

- For models equipped with the BSD (Blind Spot Detection) and RCTA (Rear Cross Traffic Alert) driving support systems, when towing a trailer, it may be necessary to select “BSD/RCTA” to deactivate the system. The system may not operate as expected due to obstruction of the radar waves. For details about how to turn BSD/RCTA off, refer to page 127 in this Getting Started Guide and/or “Starting and Operating” in your Owner’s Manual.
- For models equipped with the RAB (Reverse Automatic Braking) driving support system, when towing a trailer, it may be necessary to press the RAB button to deactivate the system. The system may not operate as expected due to obstruction of the sonar waves. For details about the RAB button, refer to page 129 in this Getting Started Guide and/or “Starting and Operating” in your Owner’s Manual.

 Please refer to “Driving Tips” in your Owner’s Manual for complete details, especially if you plan to use this vehicle for regular towing.

ADDITIONAL SPECIFICATIONS

TIRE PRESSURE MONITORING SYSTEM (TPMS)

Your Subaru has a Tire Pressure Monitoring System (TPMS) that tracks the pressure of each individual tire. You can learn more by scanning the QR code to see a video with tips and more information about your Subaru's TPMS.



Scan to learn more about the Tire Pressure Monitoring System.

The TPMS screen shows individual tire pressure in the Combination Meter Display. Use the "i" switch and arrows to display the TPMS screen.

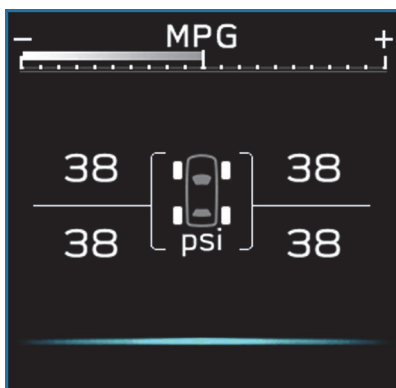

TPMS Screen

ADDITIONAL SPECIFICATIONS

Tire pressure specification is listed on the tire inflation pressure label located on the driver's side door pillar. For complete tire pressure specifications and information, please refer to the tire specifications in your Owner's Manual.



Tire Inflation Pressure Label

NOTE: The temporary spare tire, if equipped, must be used only on a rear wheel. If a front wheel tire gets punctured, replace the wheel with a rear wheel and install the temporary spare tire in place of the removed rear wheel. Outback Onyx XT and Wilderness are equipped with a full size spare tire.

OVERVIEW OF YOUR MULTIMEDIA SYSTEM

SUBARU STARLINK® Multimedia combines the radio along with the ability to connect your phone* through Bluetooth® to the multimedia system for making calls, sending text messages and listening to your favorite songs on your phone.

As part of routine maintenance and continuous improvement, Subaru releases updates to the firmware and software in your vehicle. Following the installation of these updates, the screens and menus in your vehicle may differ from what appears in this guide.

 For the most current information, please visit www.subaru.com/owners, www.subaru.com/customer-support, or contact your Subaru Retailer. Refer to page 4 for details on these resources.

* Compatible smartphone and application required. For applications to operate, latest version of each application required. Data provided by smartphone is displayed on the Touchscreen. Some state laws prohibit the operation of handheld electronic devices while operating a vehicle. Smartphone apps should only be launched when vehicle is safely parked. Your wireless carrier's rates may apply.

Various Systems

Depending on your model and trim level there are several types of SUBARU STARLINK® Multimedia systems. Some of the functions described in this guide will vary by system.

- Dual 7.0-inch Multimedia
- 11.6-inch Multimedia Plus
- 11.6-inch Multimedia Navigation

STARLINK OVERVIEW

Screen Layout

- 1 Status Bar:** The very top of the screen, which shows the outside temperature and clock. Tap on the clock display to adjust the time and other clock settings.
- 2 Information Bar:** Displays the radio station or music track you're listening to or several other screens of information. If you select the arrows on the right or left, you can scroll through the information displayed, including X-MODE® operation controls. Select the information bar to display the related screen.
- 3 Home Screen:** The main part of the display where maps, phone features, Apps and car information is accessed.
- 4 Home Buttons:** Provide shortcuts to frequently used screens:
 - Car Settings icon — Allows you to adjust a number of vehicle settings, even while driving.
 - Auto Start-Stop button — Allows you activate or deactivate Auto Start-Stop.
 - Home Button — Returns you to the home screen.
 - Manage Devices — Shortcut to the Manage Devices screen.
 - Driver Profile Button — Allows you to create or edit driver profiles.
- 5 Climate Control:** The bottom portion of the screen contains all the settings for climate control, including airflow mode, fan speed, and heated/ventilated seats, if equipped.



STARLINK OVERVIEW

Turning the Display Off: Select the Display Off button on the home screen to turn off the Center Information Display (pressing and holding the volume knob turns both the display and volume off). Briefly touch the display and operate the temperature buttons to display the standby screen, giving you access to the Auto Start-Stop button and Car Settings icon. Press and hold the volume knob to turn the screen back on.



BUTTONS

- 1 Volume:** Press the volume control knob to turn on the audio and rotate the knob to adjust the volume. Press the knob again to mute the audio.
- 2 Tune:** Rotate the knob to change the channels. Press and hold to access sound customization settings.
- 3 Car Settings:** Select to display the Car Settings menu.
- 4 Auto Vehicle Hold (AVH):** Press to activate or deactivate Auto Vehicle Hold.
- 5 Auto Start-Stop:** Press to activate or deactivate Auto Start-Stop.
- 6 Home:** Select to return to the Home screen.
- 7 Manage Devices:** Select to go directly to the manage devices screen.
- 8 Driver Profile:** Select to display, set up, or edit driver profiles.



Controlling the Volume





Adjusting the Volume: Turn the “VOLUME” knob to adjust the volume. The volume stays at your set level even after an ignition cycle.

Muting the Volume: Press and release the knob once to turn on or mute the audio.

STARLINK OVERVIEW

TOUCHSCREEN

Operations are performed by touching the screen directly with your finger.

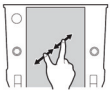
MOTION	ACTION	USE
	Touch Quickly touch and release once.	Changing and selecting various settings
	Double Touch with one finger* Quickly touch and release twice with one finger.	Enlarging the scale of the map screen
	Drag** Touch and drag your finger on the screen to move the screen to the desired position.	<ul style="list-style-type: none">• Scrolling lists• Scrolling the map screen*
	Drag with two fingers* Touch the screen with two fingers and move the displayed screen as desired.	Changing the displayed angle of the 3D map
	Swipe** Quickly move the screen by swiping with your finger.	<ul style="list-style-type: none">• Scrolling lists• Scrolling the map screen*
	Pinch* Move your two fingers further apart (pinch-out) to zoom in on the map. Move your two fingers closer together (pinch-in) to zoom out on the map.	Changing the scale of the map screen

* 11.6-inch with Navi system only

** The operations may not be performed on all screens.

STEERING WHEEL CONTROLS

- 1 Source:** Press the source button to change the audio sources between radio modes and media modes.
- 2 Presets/Skip:** Press to toggle through your presets or change a track or media file. Press and hold to scan radio stations or fast-forward/rewind.
- 3 Call and End/Mute:** Press to receive or end a call without taking your hands off the steering wheel. Press the End/Mute side to mute audio.



Starlink® Audio Controls

- 4 Voice Recognition:** Press to activate the built-in voice recognition function. Press and hold to activate the Apple CarPlay®/Android Auto™ voice recognition function.
- 5 Volume:** Press the “+” or “-” side to increase or decrease the volume.

VOICE RECOGNITION

With SUBARU STARLINK®, simple voice commands can control features like navigation, entertainment, phone calls, and, on select models, climate control. A microphone is located in the overhead console. You do not need to speak directly into it to activate the voice command features. Press the voice recognition switch to start the voice recognition system. Press and hold the switch to cancel it.

For help with what you can say with voice recognition, press the “Help” button on the screen or press the voice recognition button and say “Help”.

Tips

The system may not recognize the voice command due to various types of interference. The following are some causes for voice command interference:

- The command is spoken too quickly or at a low or high volume.
- The command is incorrect or unclear.
- The window is open, the climate control system is set on high, or the ventilation is directed toward the microphone.
- Passengers are talking while the command is spoken.

NOTE: The system is designed to recognize a variety of commands, but certain words, accents or speech patterns may be difficult for the system to recognize.



Scan to learn more about **Subaru Multimedia**.

STARLINK OVERVIEW

Common Commands

Below is a list of some of the common commands that you can use with the voice recognition system. Please refer to “Voice Recognition System” in your STARLINK® Owner’s Manual for a complete list.

VOICE COMMAND	FUNCTION	EXAMPLE
Dial [Number]	Places a call to the phone number	Dial 555-123-4567
Call [Name] [Phone Type]	Places a call to the contact name and phone type of the contact from the phonebook	Call John Doe mobile
Show Messages	Displays received text messages	Show Messages
Navigate to [House Number, Street, City, State] ¹	Sets a destination to the address	Navigate to 1234 Main Street, Lincoln, Washington
Show Map ¹	Displays the map screen	Show Map
Tune to [Frequency] (AM / FM)	Switches to AM/FM and tunes to spoken frequency	Tune to 99.5 FM
Tune to Preset [Number]	Switches to the preset channel	Tune to Preset 3
Satellite Channel [Number]	Switches to satellite channel number	Satellite Channel 58
USB	Switches source to USB	USB
Fan Speed [1-7]	Sets the fan speed to the spoken fan speed	Fan Speed 4
Set Temperature to [Number]	Sets the temperature to the spoken temperature	Set temperature to 70
Warmer	Increases the temperature	Warmer
Help	Changes to help screen	Help

¹ 11.6-inch Multimedia Navigation system only

HOME SCREEN ICONS

MySubaru – Whether you're on the road or planning adventures, the MySubaru app makes loving every part of owning your Subaru easy.

Apps – Entertainment and convenience applications to enhance your driving experience. The apps included are: MySubaru, Travel Link®, Android Auto™, and Apple CarPlay®.

Radio – Select a station to listen to as well as pause and playback live radio.

Car Info – Displays the operating status of vehicle functions, vehicle status, and vehicle inclination in the “Driving Statistics” screen. The current setting of various vehicle functions and a brief description of each function can be viewed in the “Advanced Package” screen and vehicle maintenance intervals in the “Maintenance” screen.

Map – Enter a destination and have route guidance to get you where you are going.

Media – Play CDs, USB/iPod music or Bluetooth® audio by connecting to the device.

Phone – Place and receive calls and text messages.

Settings – Change the settings to your personal choice for select systems inside the vehicle.



Home Screen Icons



Scan to learn more
about
SUBARU STARLINK®.

STARLINK HOME

REARRANGING ICONS

You can rearrange the home screen icons when in Edit Mode (first make sure "Home Screen Shortcuts" is enabled in "Settings").

To rearrange icons:

- 1 Select and hold the shortcut icon you want to move until "Edit Mode" is activated.
- 2 Drag the icon to the desired position and release.
- 3 To delete an icon, drag the icon to the area at the bottom of the screen labeled "DRAG HERE TO DELETE" and release.
- 4 To exit "Edit Mode" select the "Home" button.

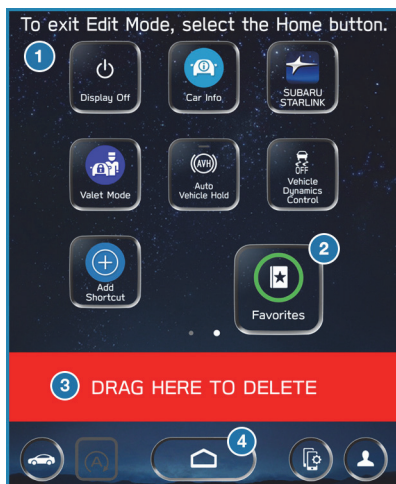

ADDING SHORTCUTS

You can add shortcut icons for various functions to the Home screen when the Home Screen Shortcut function is turned on. To turn on the Home Screen Shortcut function, go to "Settings", and then the "General" menu.

To add icons, press the "Home" button.

- 1 Select "Add Shortcut".

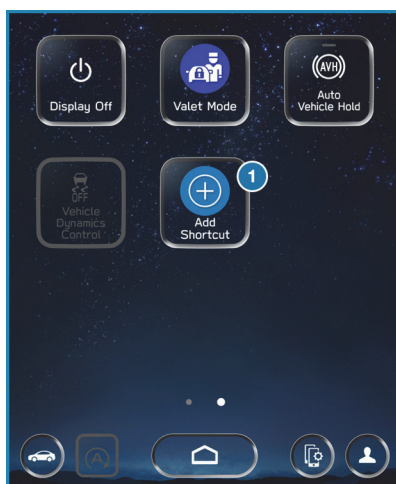

- 2 Select the desired function.

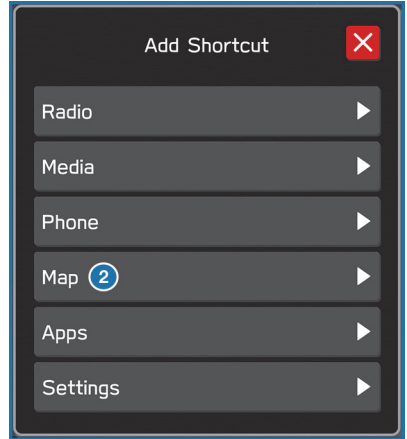

- 3 Select the desired shortcut function. Check that the shortcut icon is displayed on the Home screen.

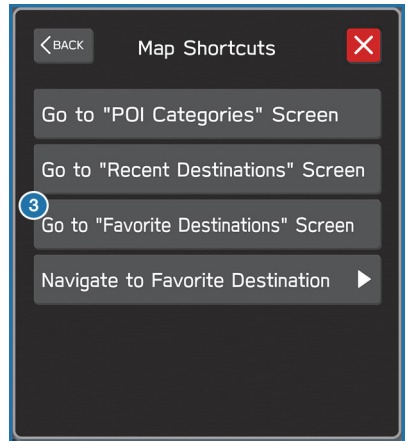

DRIVER PROFILE

CREATING A DRIVER PROFILE

Creating a Driver Profile provides many benefits beyond just pairing a phone. The profile records and remembers station presets, sound preferences, phone favorites, screen icons and placement.

To create a driver profile:

- 1 On the Home screen, select the Driver Profile button.
- 2 Select "Add".

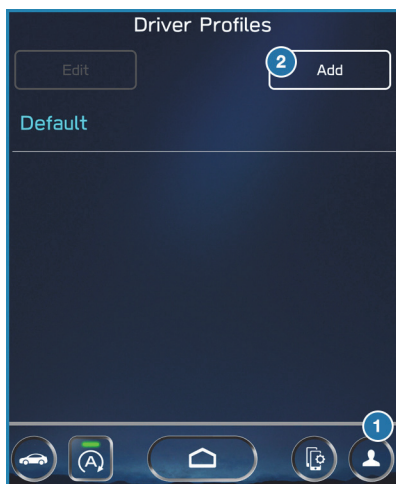

- 3 Select a language and then select "Next".



DRIVER PROFILE

- 4 Select "Driver's Name".

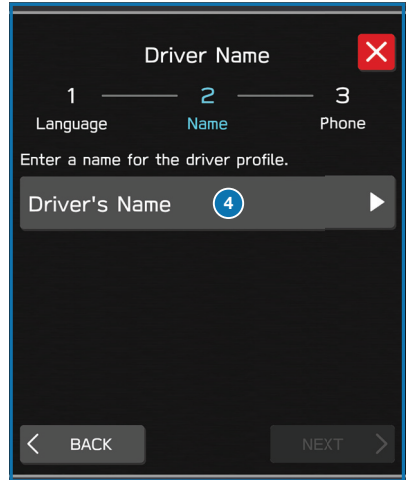

- 5 Type your name in using the keyboard screen, select "Next", and then select "Next" on the following screen to go to phone pairing.



DRIVER PROFILE

- 6 Select "Add Phone" to pair your phone to the system (see page 84 and 91 in this Getting Started Guide) or select your phone if it is already paired.
- 7 Select "Finish".

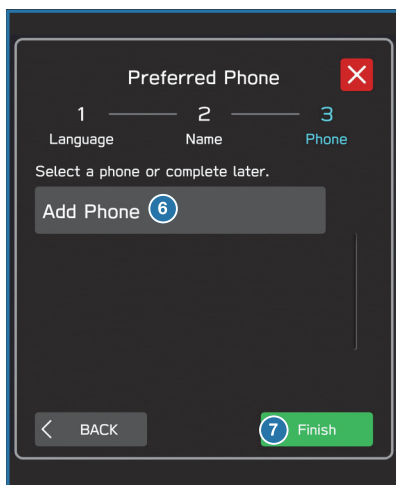

To edit a driver profile:

- 1 On the Home screen, select the Driver Profile button.
- 2 Select "Edit", then select a profile. You can then edit the profile according to same steps as creating a profile.

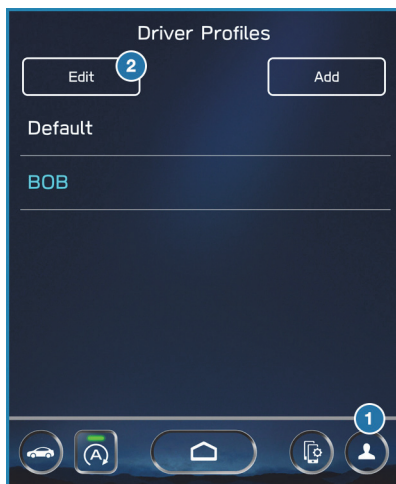

Retrieving a Driver Profile

There are two ways to retrieve a driver profile. The system may automatically retrieve the profile once you are in your Subaru with the multimedia system on and your phone's Bluetooth® active. You can also manually retrieve or change the profile by following these steps:

1. Press the "Driver Profile" button.
2. Select the profile you want. You will receive a pop up screen asking "Are you sure you want to activate this profile?"
3. Select "OK".

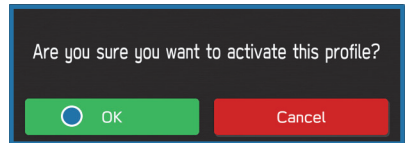

VALET MODE

The valet mode function prevents others from operating the navigation, audio, and vehicle settings in your Subaru, offering an increased level of security and peace of mind when using valet parking services. The passcode for valet mode can be set or changed in Settings in the General menu or through the MySubaru app, if subscribed.

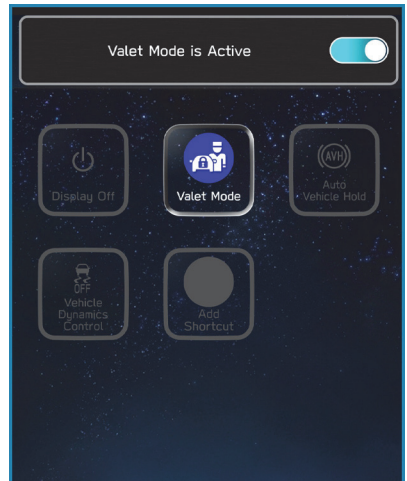

DRIVER PROFILE

Activating Valet Mode

Once you have set the passcode, valet mode can be quickly and easily activated on the home screen:

- 1 Select the “Valet Mode” button on the home screen.

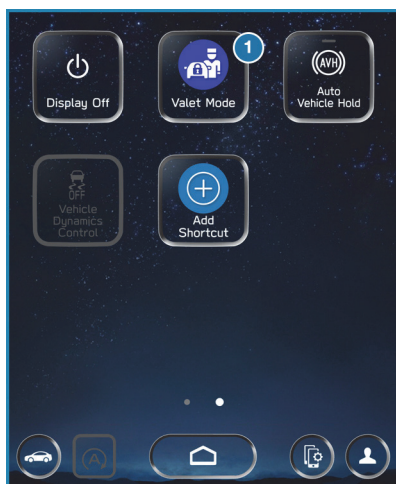

- 2 Enter your passcode using the keypad.

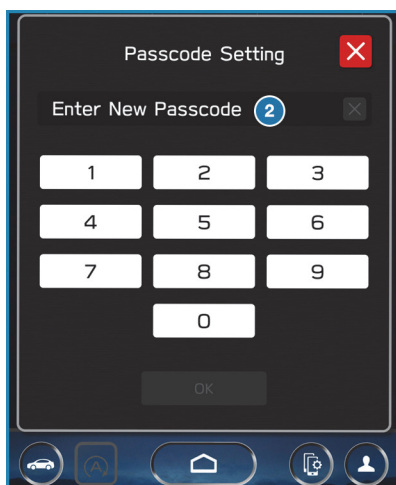

DRIVER PROFILE

- 3 Select "OK".

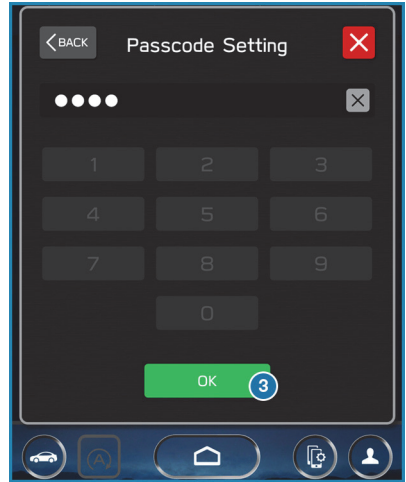

- 4 Valet mode is activated, securing your navigation, audio, and vehicle settings.

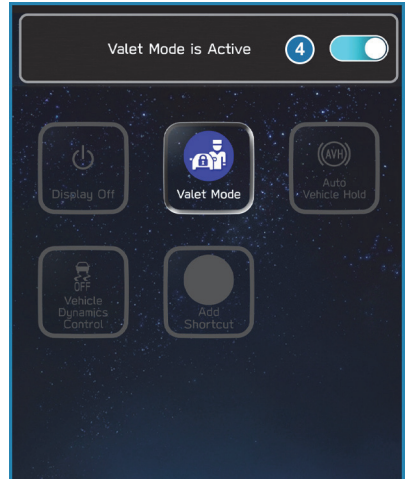

DRIVER PROFILE

Deactivating Valet Mode

Complete the following steps to deactivate valet mode and restore your personal settings:

- 1 Select the “Valet Mode” button on the home screen.

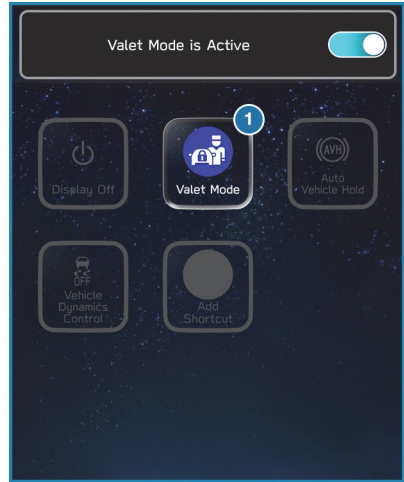

- 2 Enter your passcode using the keypad.

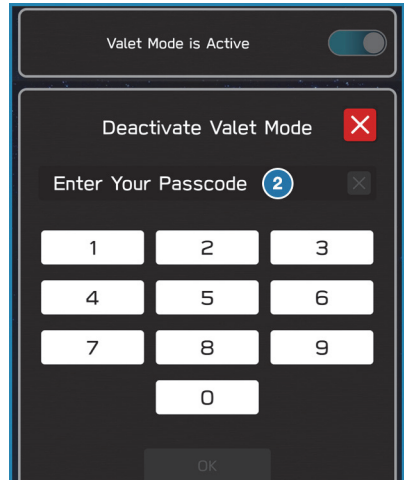

DRIVER PROFILE

- 3 Select "OK" to deactivate valet mode.

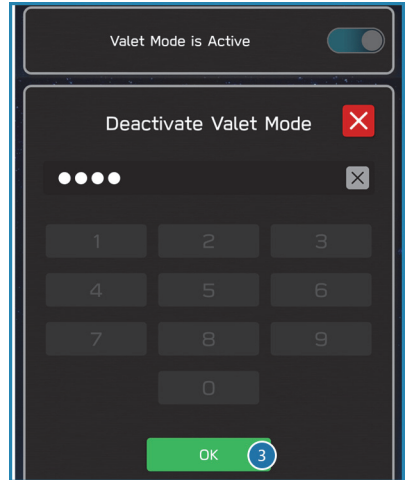

- 4 Select "OK" to initiate a facial scan from the Driver Monitoring system and restore your personal settings.

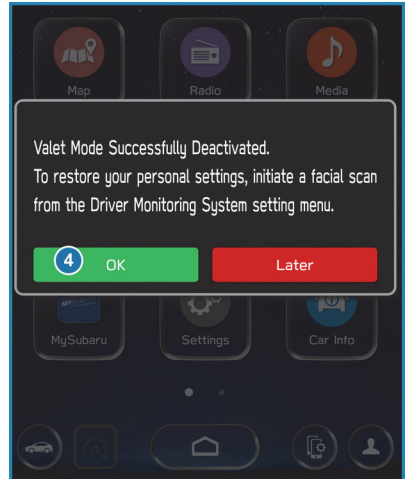

MULTIMEDIA

RADIO

AM/FM Radio

Your Subaru is equipped standard with AM/FM radio, which includes HD Radio®. HD Radio® technology is the digital evolution of analog AM/FM radio. Your radio has a special receiver which allows it to receive digital broadcasts (where available) in addition to the analog broadcasts it already receives. Digital broadcasts have better sound quality than analog broadcasts, as digital broadcasts provide free, crystal clear audio with no static or distortion.

 Visit www.hdradio.com for more information and a guide to available radio stations and programming.



Scan to learn more about HD Radio.

Satellite Radio

A SiriusXM® Satellite Radio is a tuner designed exclusively to receive broadcasts provided under a separate subscription. After a free trial period, a subscription is necessary to continue service.

For more information or to subscribe, visit www.siriusxm.com.



Presets

You can preset 18 stations. Presets can be set for SiriusXM®, FM, or AM stations, allowing you to switch among the three with the press of a single button. To preset a radio station:

1. Tune to the desired channel.
2. Press and hold one of the desired preset station buttons.



Scan to learn more about
SiriusXM Radio.



MULTIMEDIA

MEDIA

Bluetooth®

Your Subaru has Bluetooth® hands-free technology to manage your phone and audio systems. Bluetooth®-enabled mobile phones link directly through your Touchscreen automatically, once connected. Receive and initiate calls or play music directly from your device while keeping it stowed for safety.

To pair a Bluetooth® device to the Touchscreen, see page 84 for Android devices or page 91 for Apple devices.

CD (if equipped)

The CD player holds a single disc. To access the CD menu, put a CD in the player or on the Home Screen, select "Media", then select "CD". Depending on the CD format, the Touchscreen may show the CD album artwork.

USB / iPod

The USB connection is below the Center Information Display (CID). You can plug in a USB memory storage device or iPod. This will bring up the media screen with controls. If using an iPod, make sure to use an Apple certified cable or MFi certified cable for proper operation.

AUX Input

The AUX jack is a port that allows the input from an audio device such as MP3 players, portable music players and iPods. To access the AUX menu, plug in the device to the AUX jack and the menu will appear, or select the AUX menu from the Touchscreen under "Media".

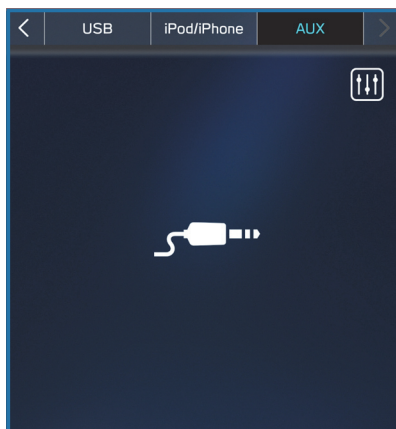

PAIRING A PHONE

Using a Bluetooth® connection with the Touchscreen allows you to use the voice recognition system to make and receive calls. It provides access to your phone book on your phone and can read incoming text messages as well as reply via voice recognition. It remembers your driver profile when your phone pairs via Bluetooth®.

Visit www.subaru.com/engineering/starlink/multimedia.html for more information on what is available by connecting a phone to the STARLINK® Multimedia system.

For instructions on how to pair your phone to the STARLINK® Multimedia system, see page 84 for Android devices or page 91 for Apple devices.



Scan to learn more
about **Subaru
Multimedia.**

PHONE

PAIRING AN ANDROID PHONE

Bluetooth® Pairing and Android Auto

- 1 Select the Manage Devices icon on your vehicle touchscreen display.
- 2 Select Add in the manage devices pop-up. Prompts appear on your vehicle touchscreen as you pair your device. Complete the actions on your phone, and then select the arrow on your vehicle touchscreen to move to the next step.

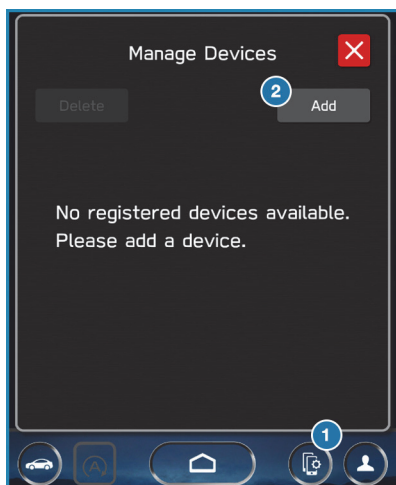

- 3 On your Android device, select "Settings" (it can be found under apps).

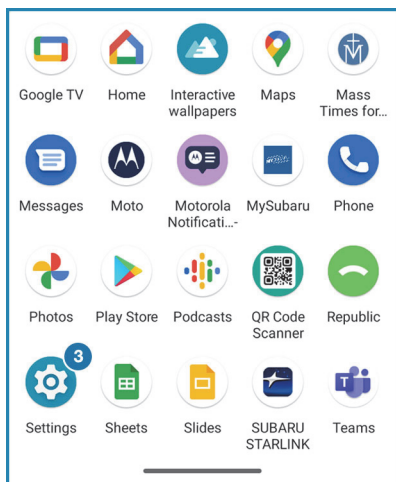

- 4 Next select Connected Devices / Bluetooth.

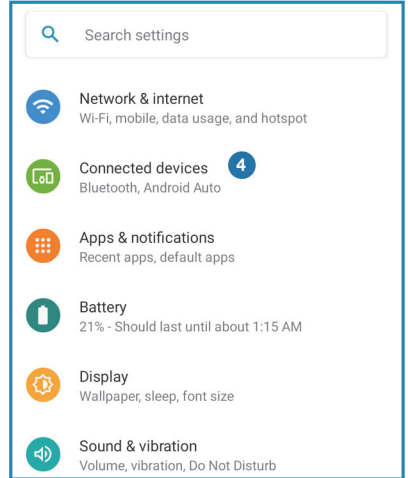

- 5 Select "Pair new device" or a list may already be showing of nearby devices to add.

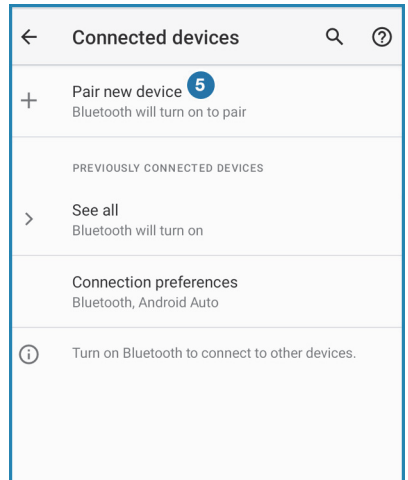

PHONE

- 6 Select your vehicle name from the list of available devices.

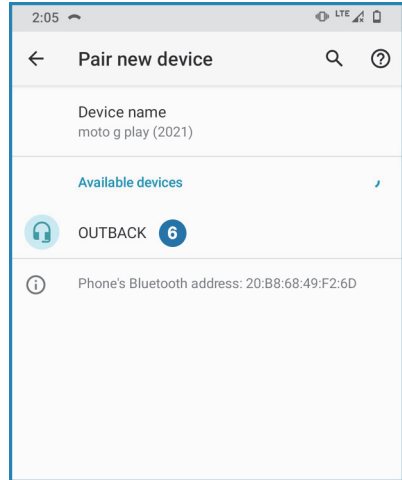

- 7 Confirm the PIN matches the numbers displayed on your vehicle touchscreen display and select "Pair" on your phone.

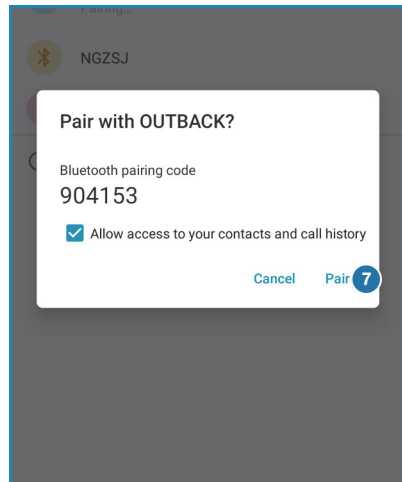

- 8 Select Allow on the “Allow Access to Messages” pop-up box on your Android phone, and select “Yes” if the “Contact Transfer” pop-up appears on your vehicle touchscreen display.

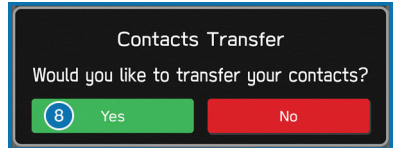
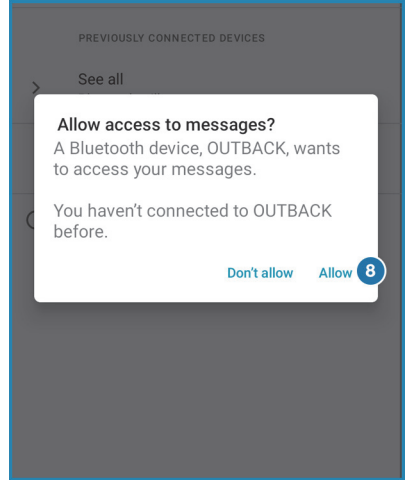

- 9 Select Yes on the “Start Android Auto” pop-up on your vehicle touchscreen display to connect to Android Auto. NOTE: If you do not wish to activate Android Auto, select No. Only Bluetooth® will be set up. You can still activate Android Auto later by selecting the Manage Devices icon on the home screen.

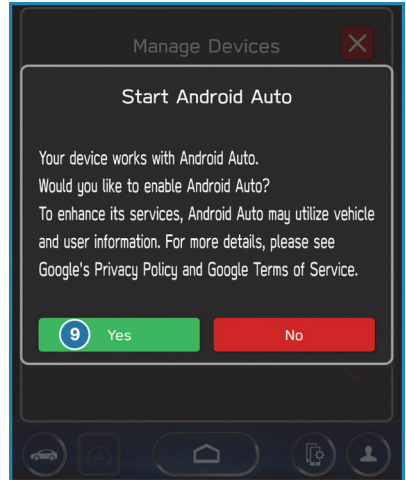

PHONE

- 10 Android Auto should auto launch on your vehicle touchscreen. If not, select the Home button, and then select the Android Auto button on the home screen.



Android Auto Best Practices

To get the best out of your Android Auto experience, make sure of the following:

- Ensure the Android Auto App is installed from the Play Store.
- If connecting with a USB cable for the first time, ensure it's a quality Android approved cable with no adapters or splitters in between your phone and the vehicle USB port.
- Ensure the Android phone operating system is fully up to date.
- Ensure all other apps that work on Android Auto are up to date (for example, Google Maps, Waze, Spotify, and others). Android Auto might not function correctly if one of these apps is outdated or having an issue. Apps can be updated in the "Play Store" app.

If Android Auto won't launch for the first time, follow these steps:

1. On your Android Phone, go to Settings, select Apps, and then select Android Auto.
2. Select Storage.
3. Select Clear Storage and Clear Cache
4. Select the Manage Devices icon on your vehicle touch screen display.
5. Select Delete, and then select the Android phone to delete it from the system.
6. Start the Connection process again or try connecting via USB cable to initiate the wireless Android Auto connection.
7. If issues persist, uninstall the Android Auto app from your phone and reinstall the app from the Play Store.

 Visit the Android Auto website for the latest info, FAQs and device compatibility:
<https://www.android.com/auto/>

PHONE

Android Auto Compatible Models and Cables

Android Auto™ is available on Android phones. To see if your phone is compatible, please refer to the Android Auto™ website:

<https://www.android.com/phones/>

When using a cable to connect to Android Auto™, always use a high-quality OEM USB cable. Ensure the Android phone is fully up to date. Also, verify that the Android Auto™ app, along with all other apps that work with Android Auto™, are up to date. Android Auto™ might not function properly if one of them is outdated or having an issue. The apps can be downloaded on Google Play.

 For more information, visit <https://www.android.com/auto/>



Scan to see if
your phone is
compatible with
Android Auto



Scan to learn
more about
Android Auto

PAIRING AN iPhone

Bluetooth® Pairing and Apple CarPlay

- 1 Select the Manage Devices icon on your vehicle touch screen display.
- 2 Select Add in the manage devices pop-up. Prompts appear on your vehicle touch screen as you pair your device. Complete the actions on your phone, and then select the arrow on your vehicle touchscreen to move to the next step.

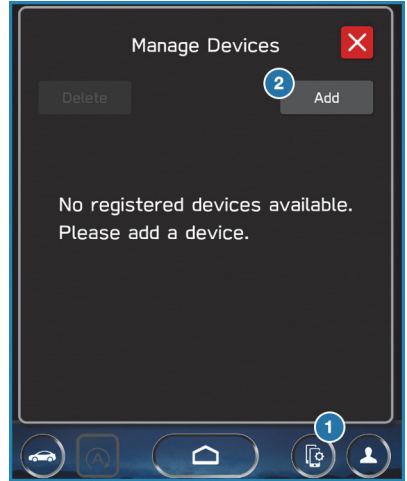

- 3 On your iPhone, select Settings.

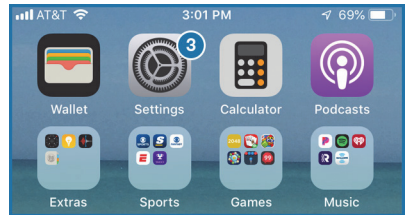

PHONE

- 4 Select "Bluetooth" on your iPhone.

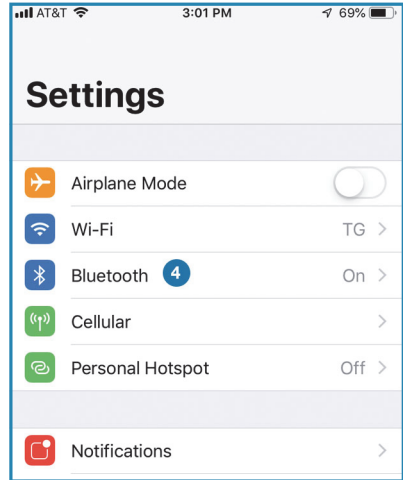

- 5 Select your vehicle from the device list.

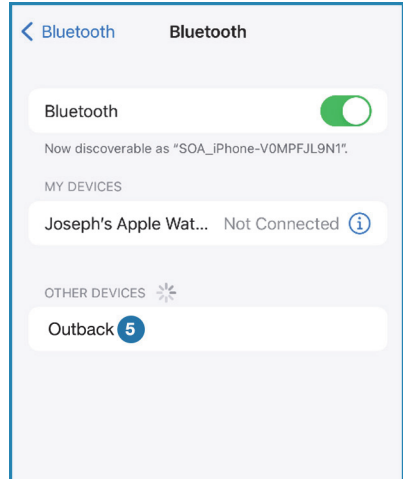

- 6 Verify your iOS/Apple device PIN is correct and select “Pair”.

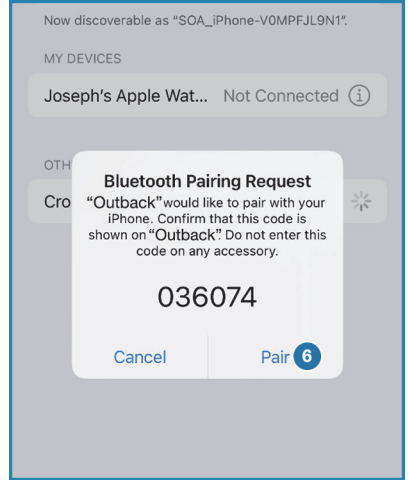

- 7 Select Allow for contacts and favorites to sync from your iPhone and select “Yes” if the “Contact Transfer” pop-up appears on your vehicle touch screen display.

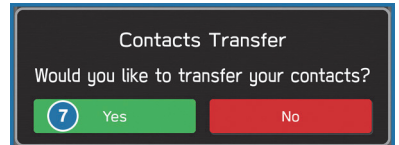
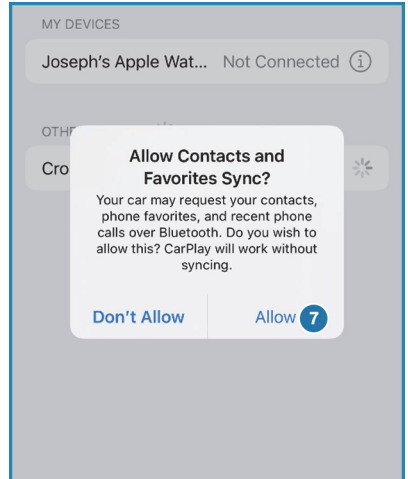

PHONE

- 8 Select Use CarPlay on your iPhone.

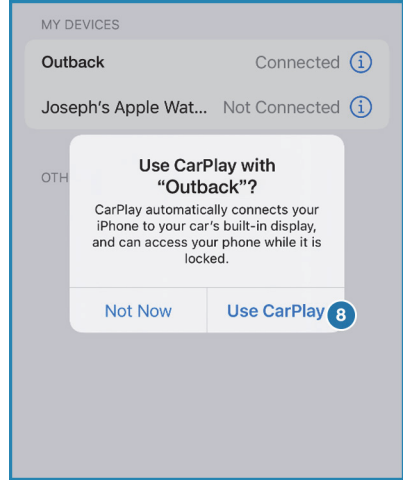

- 9 Select Yes on the "Apple CarPlay" pop-up on your vehicle touch screen display.
NOTE: If you do not wish to activate Apple CarPlay, select No. Only Bluetooth® will be set up. You can still activate CarPlay later by selecting the Manage Devices icon on the home screen. Be sure to wait for this prompt to appear on your vehicle touchscreen before changing gear positions.

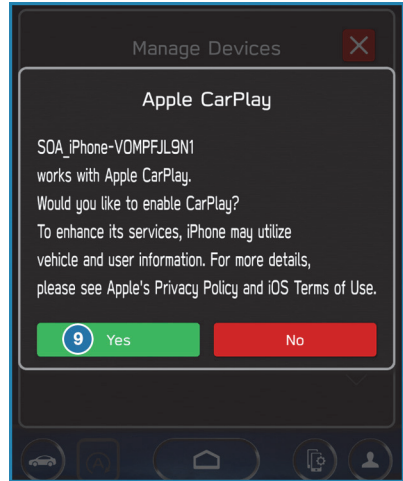

- 10 Select Yes on the Device Registration pop-up to set your iPhone to be the favorite device that will connect first when your vehicle is started.

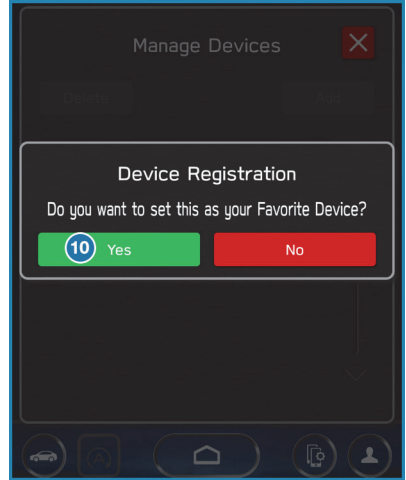

- 11 CarPlay will appear on the vehicle touchscreen. If not, select the Home button, and then select the Apple CarPlay button.



PHONE

Apple CarPlay Best Practices

To get the best out of your Apple CarPlay experience, make sure of the following:

- Ensure your iPhone is fully up to date.
- Ensure all other apps that work on Apple CarPlay are up to date (for example, Pandora, Apple Maps, Spotify, and others). Apple CarPlay might not function correctly if one of these apps is outdated or having an issue. Apps can be updated in the App Store app.

If CarPlay does not launch the first time, complete the following steps:

1. Confirm CarPlay is enabled on your iPhone by selecting Settings, then Screen Time, and then Content and Privacy Restrictions.
2. If “Content and Privacy Restrictions” are enabled, the slider will be green, which means apps like CarPlay may be disabled.
3. If so, select Allowed Apps, and ensure CarPlay is enabled (the slider is green).

If CarPlay does not launch after the above steps, try the following:

1. Go to the Settings on your iPhone and select Bluetooth®.
2. Select the blue “i” next to your vehicle.
3. Select Forget This Device.
4. Return to Settings, and now select General.
5. Select CarPlay.
6. If your vehicle is shown, select it, and then select Forget This Car.
7. On your vehicle touch screen display, select the Manage Devices icon.
8. Select Delete, and then select your iPhone to delete it from the system.
9. Start the pairing process over, or plug your iPhone into the USB port to try the process via USB connection.

iPhone Compatible Models and Cables

If using a cable to connect for Apple Carplay, the cable must be an 8-Pin Lightning MFi Certified cable (made for iPod/iPhone). Look for the “Works with Apple CarPlay®” or “Made for iPod, iPhone, iPad” icons when selecting a cable.

 For a list of all the Apple phones that are compatible with Apple CarPlay® and more information, please visit www.apple.com/ios/carplay/



Scan to learn
more about
Apple CarPlay

MAKING A CALL

With a paired phone, you can make a call through voice recognition by touching the “Voice Recognition Switch” on the steering wheel to start the voice recognition system. After pressing the “Voice Recognition Switch”, wait for the “Voice Guidance” screen to appear on the Touchscreen and say “Call [name and phone type]” or “Dial [number]”.

To make a call from the Touchscreen, start by pushing the “Home” button and then select “Phone”. After the phone screen displays, select the method you would like to use to make a call.

- Recents – Allows you to call someone that has recently called you or that you called.
- Favorites – Allows you to place a call to one of your registered favorites.
- Phonebook – Will display the phonebook that is on your phone.
- Messages – Allows you to call someone that recently sent you a text message.
- Keypad – Allow you to dial any number you would like.

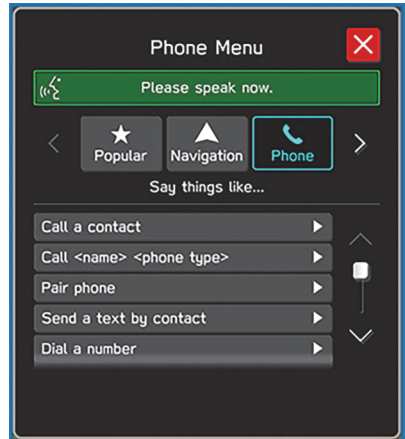

PHONE

RECEIVING A CALL

To receive a call, press the “Call” switch on the steering wheel or the “Accept” button on the Touchscreen.

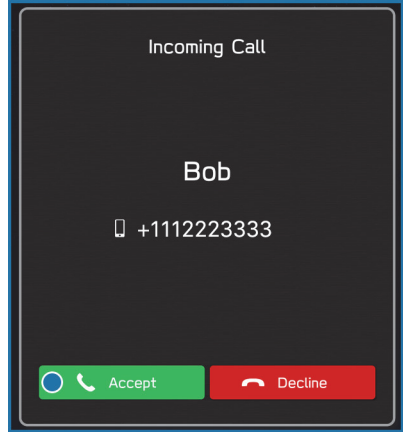

To reject a call, press the “End” switch on the steering wheel or the “Decline” button on the Touchscreen.

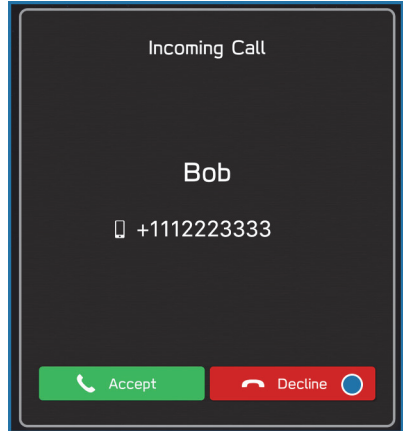

TEXT MESSAGES

Received messages can be forwarded from the connected Bluetooth® phone, enabling checking and replying using the system. To use this function, it is necessary to set the phonebook download function to ON.

When a Short Message Service (SMS)/ Multimedia Messaging Service (MMS) is received, the incoming message screen pops up with sound and is ready to be retrieved using the Touchscreen. Select “Play” to listen to the message. After listening to the message, you can also select the “Reply” button to reply to the sender using a generated message.

If there is more than one unread message, a screen will appear to allow you to either view your inbox or ignore the message.

Depending on the Bluetooth® phone type, the screen display may differ, messages may not be transferred to the message inbox, or it may not be possible to use certain functions.

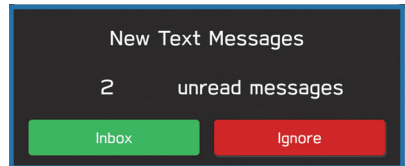
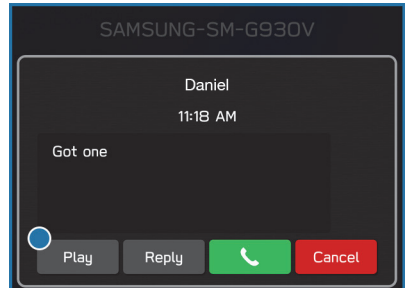

APPS

SUBARU STARLINK® IN-VEHICLE APPS

SUBARU STARLINK® Multimedia offers advanced connectivity through Apple CarPlay® or Android Auto™ apps. Wireless pairing and hands-free smartphone operation allow for safe and easy connection to your favorite apps and content.

For a complete list of all the apps available, visit www.subaru.com/engineering/starlink/multimedia.html



Scan to learn more about **Subaru Multimedia**.

Android Auto™

Android Auto™ can be used to view maps, play music, and place calls by connecting your Android device to the system. You can also run supported applications.

 For more information, please refer to page 84.

For details on the services or the operations, visit the Android Auto sites www.android.com/auto/ or www.support.google.com/androidauto/



Scan to learn more about **Android Auto**



Scan to learn more about **Android Auto Help**

To use Android Auto™ on your car display, you'll need an Android phone running Android 6 or higher, an active data plan, and the Android Auto™ app.

Apple CarPlay®

Apple CarPlay® can be used to view maps, play music, and place calls by connecting your iPhone to the system. You can also run supported applications.

 For more information, please refer to page 91.

For details on the services or the operations, check the Apple CarPlay® site: www.apple.com/ios/carplay/



Scan to learn more about **Apple CarPlay**

SiriusXM® Travel Link

SiriusXM® U.S. satellite and data services are available in the 48 states of the contiguous USA and DC.

Data service information, comprising fuel prices, sports, stocks, weather, weather alerts, and parking, can be received via the SiriusXM® Radio.

To receive the data service information in the vehicle, a subscription to the SiriusXM® Satellite Radio Service is necessary following a free trial.



MYSUBARU

Whether you're on the road or planning adventures, the MySubaru app makes loving every part of owning your Subaru easy. Although the mobile app is great when you are on the go, you can also visit www.MySubaru.com from your computer to access the same functions and to aid in planning your trip before you leave.

You can download the MySubaru app on Google Play or the Apple App Store on your phone by searching MySubaru.

By creating an account, you can:

- Schedule service with a Preferred Subaru Retailer
- Get vehicle service reminders, recall alerts, and exclusive coupons
- Track and record your service history
- Access resources like your owner's manuals, how to videos and more
- Have access to SUBARU STARLINK® Safety and Security features (must have an active SUBARU STARLINK® subscription)
- Get help from enhanced roadside assistance (requires active SUBARU STARLINK® subscription)



Scan to get the
MySubaru App.

APPS

Service Appointment Scheduler

The SUBARU STARLINK® Service Appointment Scheduler can help you set an appointment from the MySubaru website, Mobile App or the vehicle's Touchscreen. Getting your Subaru vehicle to the Subaru professionals for service is easy, no matter where you are. If you are away from your preferred Subaru Retailer for service, you can always use Service Appointment Scheduler to locate any of our certified Subaru Retailers near your location.

SUBARU STARLINK® Service Appointment Scheduler on your Touchscreen is a convenient way to set a service appointment. Simply select the MySubaru icon on the Home screen and choose "Make an Appointment" to get started.

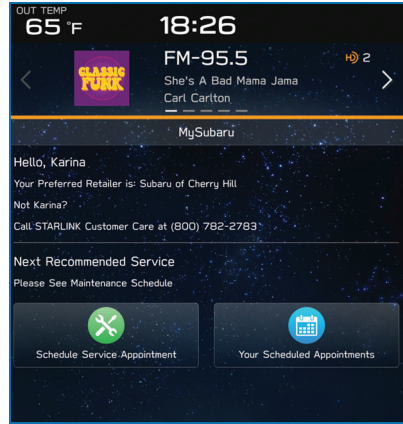

MAPS OVERVIEW

Your new SUBARU STARLINK® comes equipped with an integrated navigation system, powered by TomTom®. We hope you enjoy the state-of-the-art navigation technology and optimized mapping routes to guide you on safer, better, and more enjoyable journeys.

With your integrated navigation system, you can find destinations by address or search by points of interest, as well as save destinations in the system as favorites. You can also customize route options and settings and find the nearest gas station along your route with the touch of a button.



Scan to learn more about the features of your navigation system.

i For more information and step by step directions on using your navigation system, please refer to page 150 in this Getting Started Guide or “Navigation System (If equipped)” in your STARLINK® Owner’s Manual.

What3words

What3words is an innovative addressing system that divides the world into 3 meter (about 10 ft.) squares and assigns each square a unique combination of three words. This functionality is seamlessly integrated into your navigation system, making your everyday adventures easier than ever. For example, What3words enables you to conveniently find and share locations as specific as building entrances and parking spots with your friends, and provides easy location references in places with no street addresses, such as beaches, national parks, and remote hiking trails.



i For more information and step by step directions on using What3words with your navigation system, please refer to page 155 in this Getting Started Guide or “Navigation System (If equipped)” in your STARLINK® Owner’s Manual.

STARLINK SAFETY AND SECURITY

SAFETY AND SECURITY OVERVIEW (if equipped)



STARLINK® Safety and Security services* are designed to help in your time of need. These include Advanced Automatic Collision Notification, SOS Emergency Assistance, Enhanced Roadside Assistance, Stolen Vehicle Recovery, the added convenience of Remote Engine Start with Climate Control, and so much more.

With the SUBARU STARLINK® system integrated into your vehicle, advanced safety and security technology is just a button press away. The SUBARU STARLINK® experience includes in-vehicle call center support, maintenance and diagnostic alerts as well as remote services that keep you connected to your Subaru vehicle.

Located in the overhead console of most Subaru vehicles are the red SOS  and blue i-button . Both buttons link you to the SUBARU STARLINK® call centers that are there to support you 24 hours a day, 7 days a week.

The SOS button  is for SOS Emergency Assistance.

The i-button  is for Enhanced Roadside Assistance or Concierge (if subscribed).

- Press the SOS button  for SOS Emergency Assistance.*
- Press the i-button  for Enhanced Roadside Assistance* or Concierge* (if subscribed).*
- To cancel a SOS Emergency Assistance, Enhanced Roadside Assistance or a Concierge call, press and hold the same button for approximately two seconds or select the “End Call” button if displayed on the Touchscreen.



Head to www.Subaru.com/STARLINK to see all the SUBARU STARLINK® subscription services and packages.

* Access to STARLINK® Safety and Security services requires an active STARLINK® subscription. Not available in all States. See Retailer for details. Remote Engine Start available on keyless access with push-button start vehicles. Remote Engine Start with Climate Control is available on select models only. Not available on vehicles with manual transmission. See Retailer for details or visit the STARLINK® page on Subaru.com to learn more.



Scan to learn more about SUBARU STARLINK.

STARLINK SAFETY AND SECURITY

ENROLLMENT

To enroll in SUBARU STARLINK® and access remote services, a MySubaru account is required. MySubaru is the Subaru owner website that allows you to access vehicle remote services, user preferences, diagnostic alerts and other useful features enabled by your STARLINK® Safety Plus, STARLINK® Security Plus and STARLINK® Concierge subscription.

Your Retailer may have created an account for you during the delivery process. However, you can also create a MySubaru account at www.mysubaru.com.

Enrollment in SUBARU STARLINK® can be done online at MySubaru.com, through the MySubaru Mobile App, at your Subaru Retailer or by calling a STARLINK® Customer Care Representative at: 1-855-753-2495

NOTE: Please have your Vehicle Identification Number (VIN) available, as you will need it to complete this step. After the enrollment process, you will learn more about the features in detail at MySubaru.com.

MYSUBARU INTEGRATION

The connection between you and your Subaru has never been simpler, and the MySubaru website (MySubaru.com) and MySubaru Mobile Application are the best ways to stay in touch with your Subaru vehicle. From MySubaru, you can access the following information and STARLINK® Safety and Security services*:

- Remote Services
- Vehicle Health
- Usage Reports
- Service Appointment Scheduler
- Vehicle Maintenance Schedules
- Destination to Vehicle
- Service History
- Support Resources

* Activation with subscription required. Features and availability vary by vehicle and trim level. See your Retailer for details.

STARLINK SAFETY AND SECURITY

SUBARU STARLINK® WI-FI HOTSPOT (if equipped)

SUBARU STARLINK® in-vehicle Wi-Fi Hotspot* keeps you and your family connected using AT&T's 4G LTE nationwide cellular network. Whether watching movies, playing games or even listening to music, your family won't miss a beat with SUBARU STARLINK® in-vehicle Wi-Fi Hotspot. Set up is quick and easy.

 For more information on a subscription and step by step enrollment instructions, please refer to page 149 in this Getting Started Guide or visit:

<https://www.att.com/plans/connected-car/subaru.html>

* Internet access is purchased separately through AT&T with monthly, per gigabyte, and unlimited data options available. Existing AT&T customers have the option to add an additional line to their AT&T Mobile Share plan. Available on select models.



Scan to learn
more about **AT&T**
Wi-Fi Hotspot

SETTINGS AND UPDATES OVERVIEW

Many settings can be customized for different features in your Subaru. In this section you will find examples and instructions for some of the settings you can tailor to fit your preferences, as well as ways to keep your system updated.

Connect to Home Wi-Fi (Navigation Models Only)

Connecting to your Wi-Fi network can allow you to update the maps. Wi-Fi can be found from the Home Screen by selecting “Settings”. To access Wi-Fi settings and available networks:

- 1 In the “General” menu, select “Wi-Fi Settings”.
- 1 For step by step instructions on connecting to Wi-Fi, please refer to page 147 in this Getting Started Guide or “Settings” in your STARLINK® Owner’s Manual.



SETTINGS AND UPDATES

SOUND

To change the sound settings, press the “Home” button and select “Settings”, then “Sound”. Choose the setting you want to change.

SETTING	FUNCTION
Audio	<p>In the audio settings, you may have the following setting capabilities:</p> <ul style="list-style-type: none">• Sound Customization — This function allows you to set the Equalizer, Balance/Fader and Vocal Image Control.<ul style="list-style-type: none">• Equalizer — How good an audio program sounds is largely determined by the mix of the treble, mid and bass levels. In fact, different kinds of music and vocal programs usually sound better with different mixes of treble, mid and bass.• Balance/Fader — A good balance of the left and right stereo channels and of the front and rear sound levels is also important. Keep in mind that when listening to a stereo recording or broadcast, changing the right/left balance will increase the volume of 1 group of sounds while decreasing the volume of another.• Vocal Image Control — Extracts only vocal sound from whole sound and adjusts volume balance off vocals only.• Sound Restorer — This function plays compressed audio with quality near original sound by adding the complement signal of high tone.• Virtual Bass — This function corrects the bass sound by adding harmonic sound.• Dynamic Beat Enhancer — This function expands the dynamic range lost in data compression and creates a sharp beat sound.• Speed Volume Control — The system adjusts to the optimum volume and tone quality according to vehicle speed to compensate for increased vehicle noise.• AUX Volume Gain — Sets the AUX volume gain.
Navigation Guidance Volume	Sets the navigation prompt volume.
Notification Volume	Sets the interrupt guidance volume.
Beep Sound Setting	Turns the tone sound on or off.
Beep Sound Volume	Sets the tone sound volume.
Phone Ringtone Volume	Sets the ringtone volume.
Incoming Call Volume	Sets the volume of the received call.
Call Volume	Sets the call volume.

SETTINGS AND UPDATES

SETTING	FUNCTION
SMS/MMS Ringtone Volume	Sets the SMS/MMS ringtone volume.
SMS/MMS Read Out Volume	Sets the SMS/MMS read out volume.
Voice Volume	Sets the voice recognition prompts volume.
Last Audio Volume Memory	Select to enable/disable memorizing the volume level of the audio source last used when the audio system is turned off or when the audio sources are changed.

PHONE

This system supports Bluetooth[®], a wireless data system, allowing you to make and receive calls without taking your hands off the steering wheel.

In the settings menu, you will be able to manage devices, adjust phone book and message settings, and adjust other phone/Bluetooth[®] settings.

To access the phone settings screen, press the “Home” button, select “Settings”, then select the “Phone” menu.

MAPS/NAVIGATION

There are many settings that can be customized to your preference. These settings are under the “Setting” menu and then “Navigation”. Below are some of the common settings you may want to customize:

SETTING	FUNCTION
Show Along Route	Turn the display for parking lots, gas stations and rest areas on or off for the route being traveled during route guidance.
Arrival Distance/Time	Sets the display for the estimated remaining distance and estimated remaining time to the destination.
Freeway Exit Preview	Sets the freeway exit preview to on or off.
Automatic Zoom	Sets whether to automatically enlarge the map when approaching intersections or turning points during route guidance on or off.
Auto-Hide Route Bar	Sets the route bar auto-hide function to on or off.
Route Preference	Sets the preferred route type when searching for a new route.
Avoid	Sets avoidance criteria for the route calculation.
Traffic Warning Tone	Sets the traffic alert sound to on or off.
Map Update	Sets the updating of the map data.

SETTINGS AND UPDATES

Checking for Map Updates

You can update the maps to the latest information. The maps should be checked and updated regularly for the best possible navigation experience.

At www.subaru-maps.com, you can update the entire USA map at once via USB. The maps can also be updated over the air. When updating over the air, you can update eight regions at a time. This allows you to update your home state without having to download the entire map program for the United States. This option is great if you normally stay in your home state and/or surrounding states.

Updating Over-the-Air

To check for available updates over-the-air, first connect to a Wi-Fi network (see page 147). Map updates can be found by selecting “Settings”, then “Navigation” on the Touchscreen.

 For step by step directions for updating your maps through Wi-Fi, please refer to page 165.

Updating Maps Using Your PC/MAC

Maps can also be updated using a USB memory device, which will allow the entire map program to be updated at one time. This is a great option if you are going to take a cross-country trip and your maps have not been updated in a while.

To update the map using a USB memory device, start by going to www.subaru-maps.com.



Scan to learn
more about
Map Updates

SETTINGS AND UPDATES

CLOCK

Clock settings can be adjusted when the ignition is in the “ON” position. You can adjust the clock manually or set the clock to adjust automatically on the clock setting screen. To access the clock setting screen with a single step:

- 1 Select the clock on the status bar at the top of the Center Information Display.
- 1 For more information on clock settings and full step-by-step instructions on adjusting the clock both manually and automatically, please refer to page 138 in this Getting Started Guide.



EYESIGHT

EYESIGHT® OVERVIEW

Your Subaru features a variety of safety systems that are the culmination of everything Subaru Engineers know about safety. These systems are referred to as “Driver Assist Technologies” and add confidence to every trip you and your passengers take. Working together, these systems provide enhanced awareness, safety, and convenience in front, to the sides, and behind your Subaru. Subaru Driver Assist Technologies include:

- EyeSight® Driver Assist Technology
- Rear-Vision Camera
- Pre-Collision Braking
- Automatic Emergency Steering
- Front View Monitor
- Blind-Spot Detection (BSD)
- Rear Cross-Traffic Alert (RCTA)
- Reverse Automatic Braking (RAB)
- High Beam Assist (HBA)
- Lane Departure Prevention
- Steering Responsive Headlights (SRH)

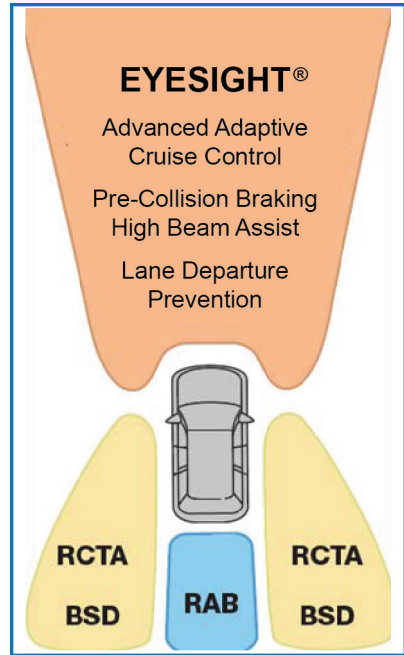

OPERATION

EyeSight® is a driver assist technology that uses dual stereo cameras, and if equipped, an additional wide-angle mono camera, to identify vehicles in front, pedestrians, traffic lanes, or other objects. If need be, the EyeSight® system can apply the brakes and/or reduce engine power to help avoid or reduce the severity of a collision. During these events, the system will provide audible and visual alerts to assist you in making decisions.

Since the characteristics and limitations of the EyeSight® cameras are similar to human eyes, it is important that the cameras, windshield, and area in front of the cameras are treated with special care. Please refer to “Care and Limitations” on page 135 in this Getting Started Guide for more details.



EyeSight® Cameras (inside)



EyeSight® Cameras (outside)

FUNCTIONS

The EyeSight® system features several distinct functions designed to provide extra awareness, improve safety, reduce fatigue, and add peace of mind every time you drive your Subaru. EyeSight® functions include:

- Pre-Collision Braking (PCB)
- Pre-Collision Brake Assist
- Automatic Emergency Steering
- Pre-Collision Throttle Management
- Lane Departure Warning (LDW)
- Lane Sway Warning
- Lane Departure Prevention
- Advanced Adaptive Cruise Control with Lane Centering
- Conventional Cruise Control
- Lead Vehicle Start Alert

EYESIGHT

Pre-Collision Braking

This function helps prevent or minimize a frontal collision with another vehicle, pedestrian, or other objects by providing visual and audible warnings. Warnings are displayed in the Combination Meter Display (CMD) with audible beeps. If you take no corrective action, the system automatically reduces engine power and applies the brakes with increasing force to help prevent or minimize the collision.

This system can be turned on or off in the Center Information Display (CID) (see page 123).



Pre-Collision Brake Assist

This function activates when the Pre-Collision Braking System is activated, the system determines that there is a high risk of collision with an obstacle in front, and you apply the brakes. The function assists by applying additional pressure to the braking system to decrease stopping distance.

This system can be turned on or off in the Center Information Display (CID) (see page 123).

Automatic Emergency Steering (if equipped)

The Automatic Emergency Steering function activates when the Pre-Collision Braking System has activated and there is an extremely high possibility of a collision with an obstacle ahead. When traveling at 50 mph or slower, the function uses the EyeSight[®] cameras and rear radar to determine if there is enough space to safely avoid a collision with the object ahead, detecting lane markings and making sure that there are no other objects in front as well as behind, such as oncoming vehicles or pedestrians.

Once activated, Automatic Emergency Steering provides automatic steering support to avoid the collision while staying within the lane. After a collision is avoided, the system continues steering assist and brake control to maintain the vehicle in its lane until the vehicle stops.

This function can be turned on or off by activating or deactivating the Pre-Collision Braking system (see page 123) or BSD/RCTA (see page 127).

Pre-Collision Throttle Management

This function is designed to help prevent you from unintentionally accelerating into a stopped vehicle or other obstacle by reducing engine power. Warnings are displayed in the Combination Meter Display (CMD) with audible beeps.

Pre-Collision Throttle Management is helpful when:

- You unintentionally place the select lever in the “D” position instead of the “R” position and start to accelerate toward a parked car, wall or parking structure.
- While you are at a stop, the vehicle ahead of you accelerates, but then suddenly slows down or stops as you begin to accelerate.

This system can be turned on or off in the Center Information Display (CID) (see page 123).

Lane Departure Warning

This function provides audible and visual warnings if you are about to depart your lane of travel. Using the EyeSight® camera, the Lane Departure Warning function identifies lane markings when traveling at speeds of approximately 30 mph or greater. These warnings are displayed in the Combination Meter Display (CMD) with audible beeps.

Lane Departure Warning does not provide any corrective actions.

You can turn this system on or off in the Center Information Display (CID) (see page 122).



EYESIGHT

Lane Sway Warning

This function detects repetitive or unusual side-to-side vehicle movement within a lane of travel that may indicate a drowsy or inattentive driver. Using the EyeSight® camera, the Lane Sway Warning function activates to identify lane markings when traveling at speeds of approximately 37 mph or greater and deactivates when vehicle speed falls below 25 mph. Warnings are displayed in the Combination Meter Display (CMD) with audible beeps. Lane Sway Warning does not provide any corrective actions.

You can turn this system on or off in the Center Information Display (CID) (see page 122).



Lane Departure Prevention

This function provides steering assistance to keep your Subaru in its lane of travel when cruising on expressways, freeways, and interstate highways. Using the EyeSight® cameras, the Lane Departure Prevention Function identifies lane markings when traveling at speeds of approximately 37 mph or greater.

Operate the Center Information Display (CID) to turn on the Lane Departure Prevention Function by selecting "All Functions" or "Lane Departure Prevention Function Only" on the "Lane Departure Prevention Function" screen of the EyeSight® settings.

As you drive the vehicle above the minimum speed, white lane marking graphics on the CMD indicate that right and/or left lane markings have been successfully identified by the EyeSight® camera.

If your Subaru is about to depart the driving lane, the system assists steering by gently guiding the vehicle back into your lane. When the system is actively providing assistance, the lane indicator on the side where the Lane Departure Prevention Function activated changes from white to yellow.



Advanced Adaptive Cruise Control with Lane Centering

Advanced Adaptive Cruise Control is a driving support system intended to reduce the burden on you when driving on an expressway (including during congestion and when driving at high speed). Advanced Adaptive Cruise Control and Lane Centering work together to assist you by automatically controlling the accelerator, brake, and steering.

Advanced Adaptive Cruise Control

This system provides cruise control with the ability to keep a safe distance from the car in front of you. Using the EyeSight® camera, the Advanced Adaptive Cruise Control function identifies vehicles in front of you in the same lane, and your vehicle follows the vehicle in front (up to the maximum of your set speed). While following, your vehicle will automatically maintain a following distance that corresponds to the speed of the vehicle in front.

You can turn the Advanced Adaptive Cruise Control on or off using the Adaptive Cruise Control On/Off button on the right side of the steering wheel (see page 119). Once the

system is turned on, a white Adaptive Cruise Control icon will be displayed on the Combination Meter Display (CMD). When all the operational conditions are met, “READY” appears underneath the Adaptive Cruise Control icon.

To set Advanced Adaptive Cruise Control, push down the “SET/-” switch on the right side of the steering wheel. The CMD will indicate a target speed and the icon will turn green. This speed can be adjusted up or down using the “RES +/SET -” switch (see page 119).

When a vehicle in front of you is identified, a Lead Vehicle indicator will be displayed on the Combination Meter Display (CMD). You can change the desired following distance from the lead vehicle by pressing the “Increase Distance” or “Decrease Distance” buttons (see page 119).



EYESIGHT

Lane Centering

The stereo camera detects lane markings (including Botts' dots) of the lane and the lead vehicle, and the system assists the steering operation by working with the electric power steering to help keep your vehicle in its lane when driving on expressways, freeways and interstate highways.

This function can be used by pressing the Lane Centering switch when Advanced Adaptive Cruise Control is activated. When driving at speeds of 0 mph to approximately 90 mph, the system detects the lane markings and/or the lead vehicle and assists you with steering in order to keep the vehicle close to the center of the lane.



Conventional Cruise Control

Conventional Cruise Control maintains a constant traveling speed you set, but it does not adapt to the other vehicles in front of you. To activate Conventional Cruise Control, press the Adaptive Cruise Control On/Off button to set Advanced Adaptive Cruise Control into standby status. Then, with Advanced Adaptive Cruise Control in standby status, press and hold the "Increase Distance" or "Decrease Distance" button on the steering wheel for approximately two seconds.

The Cruise Control indicator on the Combination Meter Display (CMD) will change from the Adaptive Cruise Control icon to the Conventional Cruise Control icon, and the "READY" indicator appears when all operational conditions are met. Use the accelerator to reach the desired speed, then use the RES +/SET - switch to set the vehicle speed.



Lead Vehicle Start Alert

This function will provide a visual and audible alert when a stopped vehicle in front of you begins to move, and your vehicle remains stationary. Warnings are displayed in the Combination Meter Display (CMD) with audible beeps. Lead Vehicle Start Alert is helpful in situations where you may become temporarily distracted at a traffic light, and the vehicle ahead begins to move.

Navigate the CID (select “Settings”, and then the “Car” menu) to access the EyeSight® settings menu to turn this function on or off.



STEERING WHEEL CONTROLS

Advanced Adaptive Cruise Control

- 1 **Adaptive Cruise Control On/Off:** Press to turn Advanced Adaptive Cruise Control on or off.
- 2 **Lane Centering:** Press to turn on or off Lane Centering when Advanced Adaptive Cruise Control is active.
- 3 **Increase Distance:** Press to increase the following distance setting while using Advanced Adaptive Cruise Control. Press and hold to change to Conventional Cruise Control.
- 4 **Decrease Distance:** Press to decrease the following distance setting while using Advanced Adaptive Cruise Control. Press and hold to change to Conventional Cruise Control.



Advanced Adaptive Cruise Control Switches

EYESIGHT

5 Resume (RES)/Increase Speed and Set (SET)/Decrease Speed: Press the switch down to set an initial target speed. Once set, press up or down to adjust the target speed.

• **Adjust by 1 mph:**

- Briefly press the switch up to increase the target speed in 1 mph increments.
- Briefly press the switch down to decrease the target speed in 1 mph increments.

• **Adjust by 5 mph:**

- Press and hold the switch up to increase the target speed in 5 mph increments.
- Press and hold the switch down to decrease the target speed in 5 mph increments.

Customizing EyeSight® Settings

The EyeSight® system features customization of certain preferences and warnings. Select “Settings”, and then “Car” or select the “Car Settings” icon to adjust a number of EyeSight® Settings in the Center Information Display, such as:

- Warning Volume: Min/Mid/Max
- Cruise Control Acceleration Characteristics:
 - Lv. 1 Eco
 - Lv. 2 Comfort
 - Lv. 3 Standard
 - Lv. 4 Dynamic

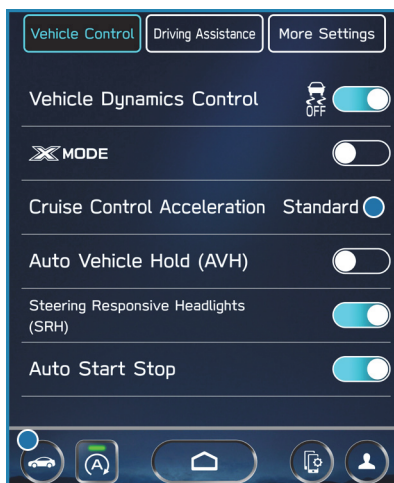

EYESIGHT® ASSIST MONITOR (EAM)

The EyeSight® Assist Monitor (EAM) provides a heads-up display of EyeSight® system functions in the lower windshield area allowing you to keep your eyes on the road ahead.

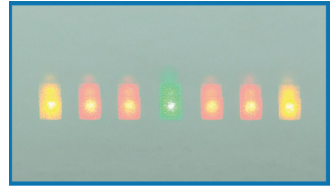

The EAM indicators can be changed by selecting “Settings”, then “Car” to access the “EyeSight® Assist Monitor” settings menu in the Center Information Display. Below are the indications provided by the EAM function:

LED COLOR	PATTERN	WARNING CONDITION
Green	Solid illumination	A vehicle is detected ahead while Advanced Adaptive Cruise Control is operating.
Yellow	Flashing on one side	Lane Departure Warning is operating. The side where the vehicle has left its lane flashes, and the side that has not left its lane illuminates.
	Flashing alternately	Lane Sway Warning is operating.
	Flashing simultaneously	<ul style="list-style-type: none"> Steering wheel operation is not be detected for a certain period of time. Lane Centering or Lane Departure Prevention Function was canceled automatically by the system (flashing rapidly).
Red	Flashing simultaneously (4 indicators)	<ul style="list-style-type: none"> Following Distance Warning, Pre-Collision Braking System (first or secondary braking), Automatic Emergency Steering (if equipped), Obstacle Detected Warning, or Pre-Collision Throttle Management is operating. Lane Centering Function was canceled when there was no operation of the steering wheel.
	Flashing on one side	Lane Centering Function is active and the vehicle appears likely to depart the lane. The side where the vehicle has left its lane flashes, and the side that has not left its lane illuminates.

EYESIGHT

LANE DEPARTURE WARNING AND PRE-COLLISION BRAKING SYSTEM OFF

Lane Departure Warning OFF

Select the “Car Settings” icon, and then in the “Driving Assistance” menu, select “Lane Departure” to choose your desired operation setting for Lane Departure Prevention, Lane Departure Warning, and Lane Sway Warning.

Lane Departure Warning/Lane Sway Warning are turned on by selecting “All Functions” or “Warning Buzzer Only.” Lane Departure Warning/Lane Sway Warning are turned off by selecting “Lane Departure Prevention Function Only” or “OFF.”

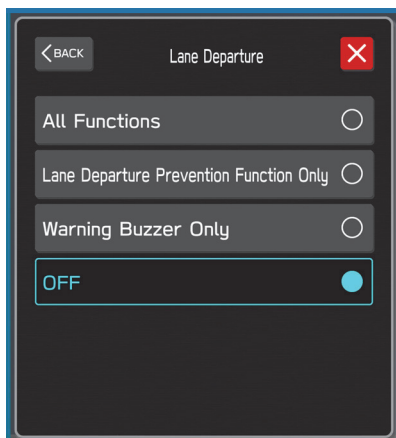

When these functions are off, a yellow Lane Departure Warning OFF indicator illuminates in the Combination Meter. It may be helpful to turn these functions off when lane markings on the road are inconsistent.



Pre-Collision Braking System OFF

Select the “Car Settings” icon, and then in the “Driving Assistance” menu, select “Pre-Collision Braking” to choose your desired setting for the Pre-Collision Braking functions.

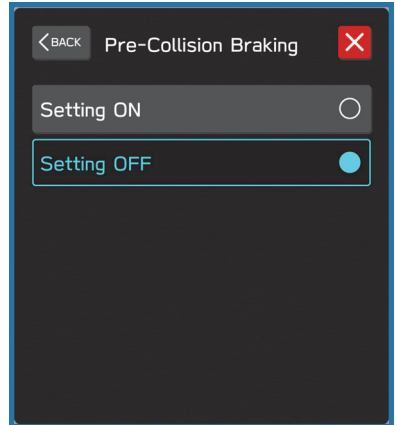

When these functions are off, a yellow Pre-Collision Braking OFF indicator illuminates in the Combination Meter. Deactivating the Pre-Collision Braking system also deactivates Automatic Emergency Steering, if equipped. When Automatic Emergency Steering is turned off, the Automatic Emergency Steering OFF indicator is displayed in the Combination Meter. It may be helpful to turn these functions off when using a drive-through carwash.



DRIVER ASSIST TECHNOLOGIES

REAR-VISION CAMERA

This function provides a clear view of the area behind the vehicle to help avoid obstacles. Using a wide-angle camera mounted on the rear of the vehicle, an image is automatically displayed on the multimedia screen when you place the select lever in the “R” position. The displayed image features a centerline indicator, colored distance markers, and dynamic guidelines that move as the steering wheel is turned.

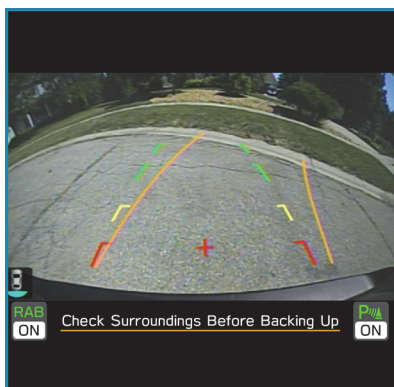

Rear-vision Camera Washer

To help keep your vision clear, your Subaru comes equipped with a Rear-vision Camera Washer. The Rear-vision Camera Washer is activated whenever the washer for the rear window is used. Rotate the end of the window wiper lever down from the off position, or up from the continuous operation position, to clean both the rear window and the Rear-vision Camera.

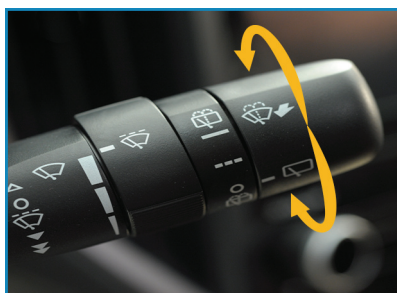

 For more information, please refer to “Instruments and Controls” in your Owner’s Manual.

DRIVER ASSIST TECHNOLOGIES

FRONT VIEW MONITOR (if equipped)

The Front View Monitor provides you with visibility from the front grille shown in the Center Information Display, improving visibility when making turns with an obstructed view or pulling into a narrow parking spot. A guide line is also displayed to provide distance and width references. The Front View Monitor can be displayed when vehicle speed is less than 12 mph and the select lever is in a position other than “R”.

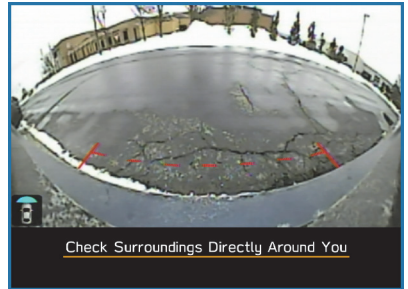

Press the Front View Monitor switch on the center console to display the Front View Monitor image on the Center Information Display (CID). You can manually turn off the Front View Monitor by pressing the Front View Monitor switch again or by pressing the Car Settings icon, Home button, or Driver Profiles icon. The function also automatically turns off.



Front View Monitor Switch

DRIVER ASSIST TECHNOLOGIES

BLIND SPOT DETECTION (BSD) / REAR CROSS TRAFFIC ALERT (RCTA) (if equipped)

This system uses radar sensors mounted behind the rear bumper on the left and right sides that warn you if another vehicle is sensed in your blind spots. These functions provide additional awareness when changing lanes or driving in reverse.

Blind Spot Detection (BSD)

Blind Spot Detection senses if a vehicle is traveling at the same relative speed in your blind spot and provides a visual warning. If the system detects a vehicle in your blind spot, the BSD/RCTA approach indicator light in the corresponding side mirror frame illuminates. If you operate the turn signal lever in the direction the BSD/RCTA approach indicator light is illuminated, the system provides an additional level of warning by rapidly flashing the BSD/RCTA approach indicator light.



Lane Change Assist (LCA)

Lane Change Assist (LCA) provides an additional level of protection by warning you of rapidly approaching vehicles in the neighboring lanes. If LCA detects a vehicle approaching at a high speed in the neighboring lanes, the BSD/RCTA approach indicator light in the corresponding side mirror frame illuminates. If you operate the turn signal lever in the direction the BSD/RCTA approach indicator light is illuminated, the system rapidly flashes the BSD/RCTA approach indicator light.

Rear Cross Traffic Alert (RCTA)

This function detects a vehicle approaching from either side as you reverse, helping you check the rear and side areas of the vehicle when moving backward. If RCTA detects a vehicle approaching from either side while moving backward, the system provides visual and audible warnings: The BSD/RCTA approach indicator light(s) on the side mirror(s) flash, the BSD/RCTA warning indicator appears in the upper corner of the Rear-Vision Camera display, and a warning buzzer sounds.

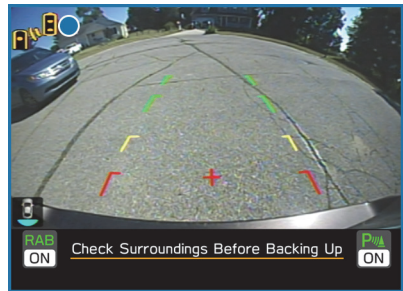

DRIVER ASSIST TECHNOLOGIES

Blind Spot Detection / Rear Cross Traffic Alert OFF

BSD/RCTA can be turned on or off in the Center Information Display (CID):

- 1 Select the “Car Settings” icon.
- 2 In the “Driving Assistance” menu, select “Rear Vehicle Detection (BSD/RCTA)” to turn the function on or off.

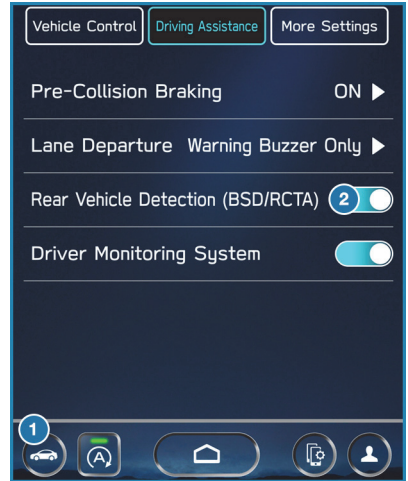

When these functions are off, a yellow BSD/RCTA OFF indicator will be displayed in the Combination Meter. Deactivating BSD/RCTA also deactivates Automatic Emergency Steering, if equipped. When Automatic Emergency Steering is turned off, the Automatic Emergency Steering OFF indicator is displayed in the Combination Meter.



DRIVER ASSIST TECHNOLOGIES

HIGH BEAM ASSIST (HBA)

This function uses the EyeSight® cameras to automatically switch the headlights between high and low beam settings, enhancing safety for both you and other drivers on the road. To activate High Beam Assist, set the headlight control switch to the “AUTO” position and push the headlight lever forward to the high beam position. The green HBA indicator illuminates on the Combination Meter.



HBA automatically activates the high beams when the forward area is dark, there are no preceding/oncoming vehicles or sharp curves in the road, and your speed is approximately 20 mph or greater. When a preceding/oncoming vehicle is detected, the forward area is bright, your speed decreases to 10 mph or less, or the EyeSight® system is malfunctioning or is temporarily stopped, HBA automatically switches to low beams.

STEERING RESPONSIVE HEADLIGHTS (SRH)

The Steering Responsive Headlights (SRH) system aims the headlight beams in the direction you are steering, improving visibility at corners and intersections when driving at night. You can turn the SRH system on or off in the Center Information Display through the “Car Settings” icon.

 For more information, please refer to “Instruments and Controls” in your Owner’s Manual.

DRIVER ASSIST TECHNOLOGIES

REVERSE AUTOMATIC BRAKING (RAB) (if equipped)

This system uses four rear bumper mounted sonar sensors to detect objects when moving between 1 and 9 mph in reverse. RAB uses the Rear-Vision Camera image to display colored proximity alerts when an object is detected. As an object becomes closer to the rear of your vehicle, audible beeps provide additional awareness in progressive levels. If RAB determines that a collision with an object is possible, the system can automatically apply the brakes to help prevent or minimize the impact.



Reverse Automatic Braking (RAB) OFF

In some cases, such as connecting a trailer, it may be helpful to temporarily turn the system off. RAB can be turned off using the buttons on the Touchscreen when the select lever is in the “R” position.

Select and hold the “RAB ON” button until it changes to “RAB OFF” to disable the automatic braking functions of the RAB system.

Select and hold the “P))) ON” button until it changes to “P))) OFF” to disable the audible beeping of the RAB system.



DRIVERFOCUS DISTRACTION MITIGATION SYSTEM (if equipped)

DRIVERFOCUS® OVERVIEW (if equipped)

Your Subaru features DriverFocus®, a state-of-the-art system that helps reduce distracted driving for both new and experienced drivers.

Working with our award-winning EyeSight® Driver Assist Technology, DriverFocus® is like having an attentive co-pilot along for the ride, available to give a helpful alert if a driver becomes distracted or drowsy. For added convenience, DriverFocus® can also recognize up to five drivers and remember their preferences, such as seat position, climate settings, and outside mirror positions.

For more information, please refer to the video linked in the QR code and to “Starting and Operating” in your Owner’s Manual.



Scan to learn more about DriverFocus®.

DRIVERFOCUS® COMPONENTS

Camera

DriverFocus® uses a near-infrared camera to focus on the driver’s eyes and head positions.



DRIVERFOCUS DISTRACTION MITIGATION SYSTEM (if equipped)

Center Information Display (CID)

The Center Information Display (CID) is used to register and delete users. Navigate the CID screens using the touch input on the CID screen.

Combination Meter Display (CMD)

The CMD provides audible signals, visual alerts, and reminders in the event you become drowsy or distracted. DriverFocus® status is also displayed in the CMD. The Status Icons Chart below explains the status icons.

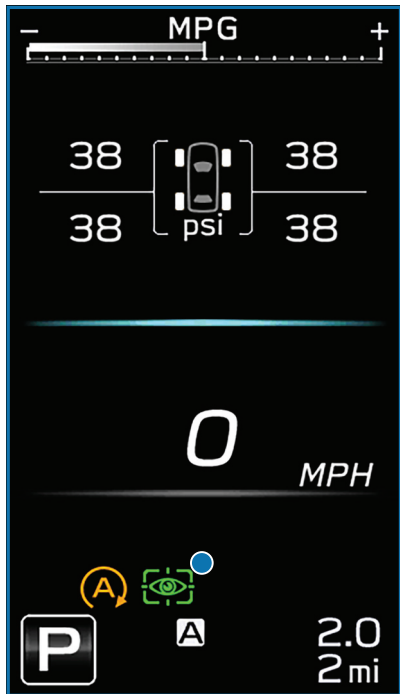

CMD

Status Icon	Indication
	DriverFocus is actively operating
	OFF (Switch was pressed)
	Temporary Stop (See Owner's Manual)
	Malfunction (Contact your Subaru Retailer)

Status Icons Chart

DROWSY/INATTENTIVE WARNINGS

DriverFocus® detects when the driver is possibly not paying attention or is becoming drowsy while driving. It works whether you are a registered user or not. The system does not provide alerts when the turn signals are operating or when the select lever is in the “R” position.

When the system perceives the driver is not paying attention, the “Keep Eyes on Road” warning will appear in the CMD along with three rapid beeps.

When the system perceives drowsy driving, various warnings will appear in the CMD along with beeps.



DRIVER PROFILE/CONVENIENCE SETTINGS

You can take advantage of convenience settings by becoming a registered driver. Preferences such as seat and side mirror memory settings, as well as some features in the Center Information Display (CID) and climate control, are uniquely linked to you.

Registering a Driver

1. With the ignition on, select “Settings” in the Center Information Display (CID).
2. In the tabs at the top of the screen, select “Car”.
3. Select “Driver Monitoring System”.
4. From the Driver Monitoring System menu, select “Register User” to add a new driver. Up to five drivers can be registered.
5. Select an open space 1-5.
6. Adjust the seat and door mirrors to your desired positions and select “Set”.
7. Face forward until you hear a beep.
NOTE: The system does not save images, audio or video.
8. Input your name and choose from an available icon.
9. Select “Set” to finish registration.

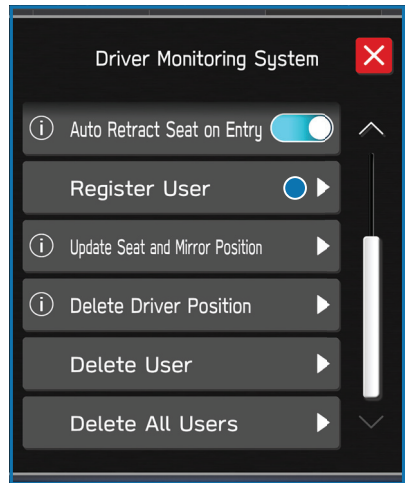

Recognizing a Driver

DriverFocus® will scan and recognize you as soon as you enter the vehicle. The Combination Meter Display will show a welcome screen with your user name and personal icon. The vehicle will also recall your user settings, such as driver seat and side mirror positions.

If the system does not automatically recognize a registered driver, you can repeat the facial scan by selecting "Settings", then selecting the "Car" menu. Select "Driver Monitoring System", then "Repeat Facial Scan".

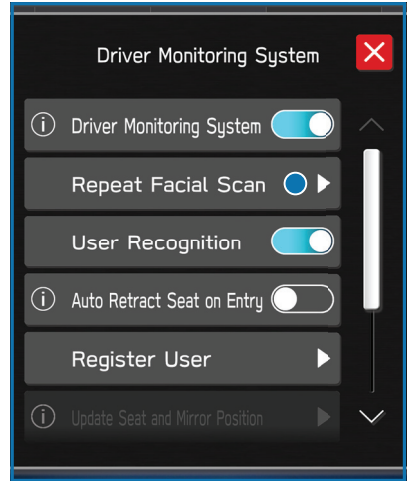

Deleting a Driver

1. With the ignition on, select "Settings" in the Center Information Display (CID).
2. In the tabs at the top of the screen, select "Car".
3. Select "Driver Monitoring System".
4. Scroll down and select "Delete User".
5. Select the driver you want to delete and select "Yes".

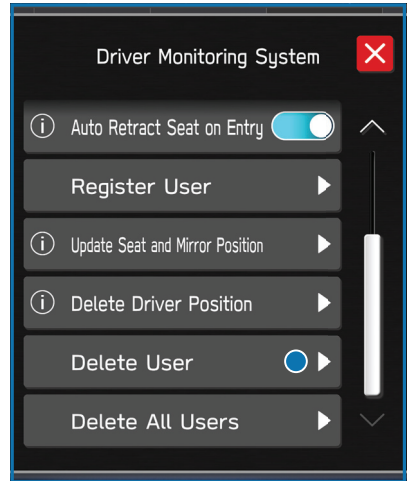

DRIVER MONITORING SYSTEM OFF

The Center Information Display (CID) is used to turn the Driver Monitoring System off or on and to customize settings. You can quickly turn the Driver Monitoring System off or on by selecting the “Car Settings” icon, and then in the “Driving Assistance” menu, selecting “Driver Monitoring System.”

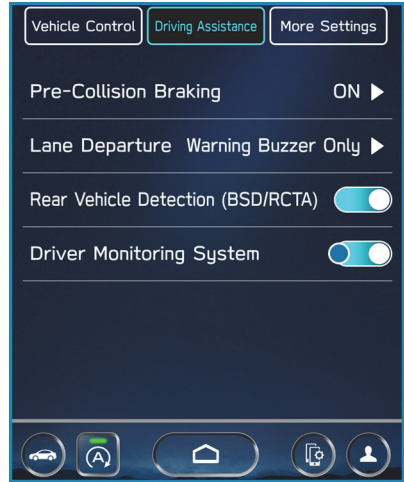

CARE AND LIMITATIONS

STEREO CAMERA PRECAUTIONS

Your EyeSight® stereo cameras are precision components that must be kept free from obstruction and contamination, such as fingerprints or cleaning solutions. When the system detects that the stereo camera lenses are impaired, a malfunction indicator will be displayed and EyeSight® functions will not be available.

When you are in the vicinity of the EyeSight® stereo cameras, always observe the following precautions:

- Do not touch or attempt to clean the EyeSight® camera lenses inside the vehicle. Extra caution should be used when cleaning the inside of the windshield. Over-spray from cleaning solutions may impair or even damage the camera lenses. Please inform others who may attempt to clean the windshield, such as car wash staff, of this precaution.
- Adjust the rearview mirror so it does not obstruct the stereo cameras' field of vision.
- Do not install any interior rearview mirror accessories, such as a wide-type mirror or hanging objects. Only approved Genuine SUBARU accessories may be installed.

 For more detailed information, please refer to your EyeSight® Owner's Manual.

WINDSHIELD GLASS AND DASHBOARD

Since the characteristics and limitations of the EyeSight® stereo cameras are similar to human eyes, it is important that the area in front of the cameras be kept free from dirt, scratches, cracks, fogging, or accessories mounted to the windshield, hood or dashboard. Visual impairments or reflections can affect EyeSight® system performance. Extra caution should be taken when cleaning the windshield to prevent over-spray from cleaning solutions.

The image in the following section outlines those areas that must be kept clean and free from obstruction. Please refer to the Owner's Manual for a complete listing of limitations.

FRONT VIEW

OUTBACK

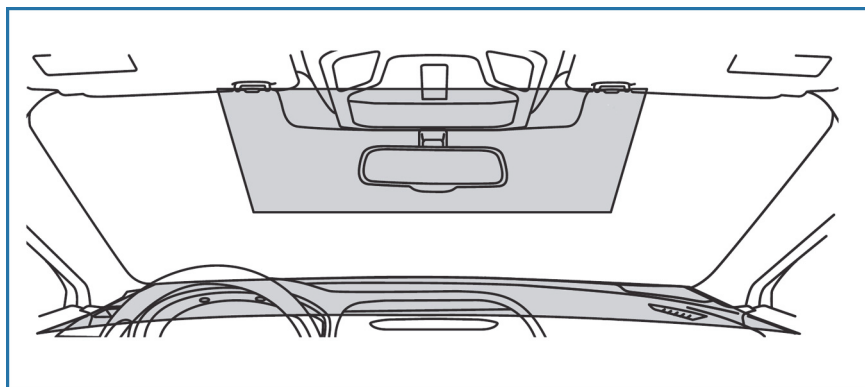

Do not place stickers or objects in the prohibited area (in gray).

EYESIGHT DISCLAIMER

EYESIGHT® DISCLAIMER

EyeSight® is a driver assist technology which may not operate optimally under all driving conditions. The driver is always responsible for safe and attentive driving. System effectiveness depends on many factors such as vehicle maintenance, weather and road conditions. See Owner's Manual for complete details on system operations and limitations.

The Pre-Collision Braking system is designed to provide automatic braking that either prevents a collision or reduces the severity of a frontal impact.

The Pre-Collision Throttle Management system is designed to reduce acceleration and minimize the severity of certain frontal impacts.

Advanced Adaptive Cruise Control and Brake Light Recognition are designed to assist the driver and are not substitutes for safe and attentive driving.

Lane Centering function operates only when used in conjunction with Advanced Adaptive Cruise Control.

Lane Departure Prevention operates only when the lane markings are visible, and system effectiveness depends on many factors.

Blind-Spot Detection, Lane Change Assist and Rear Cross Traffic Alert are systems designed to assist the driver by monitoring the rear and side areas of the vehicle during a lane change or reversing and are not a substitute for safe and attentive driving.

The Reverse Automatic Braking System is not a substitute for safe and attentive driving. System effectiveness depends on many factors, such as vehicle maintenance, weather and road conditions. Always exercise caution and use vehicle mirrors and the Rear-Vision Camera when backing up. See Owner's Manual for complete details on system operation and limitations.

The Driver Focus Distraction Mitigation System is a driver recognition technology designed to alert drivers if their attention to the road wavers or if the driver's face appears to turn away. The driver is always responsible for safe and attentive driving. System effectiveness may be affected by articles of clothing worn on the head or face. See Owner's Manual for complete details on system operation and limitations.

HOW TO APPENDIX

HOW TO OVERVIEW

This “How To” appendix provides detailed, step-by-step instructions to easily connect with features of your Outback.

If you need some help with these features or want to learn more, we are here to assist you:

Your Subaru Owner’s Manuals:

Located in the glovebox

Online Subaru Owner’s Resources:

www.subaru.com/owners

Subaru Customer Support:

www.subaru.com/customer-support

1-800-782-2783 (1-800-SUBARU3)



Scan to learn more
about **Owner's
Resources**.



Scan to learn more
about **Customer
Support**.

SETTING THE CLOCK

Clock settings can be adjusted when the ignition is in the “ON” position. You can adjust the clock manually or set the clock to adjust automatically in the clock setting screen. To directly access the clock setting screen, you can select the clock on the status bar at the top of the Center Information Display. Full directions for accessing the clock settings and adjusting the clock manually or automatically are given in the following sections.

 For more information, please refer to “Quick Guide” in your STARLINK® Owner’s Manual.

Manually

To set the clock manually:

- 1 Select the Clock Display in the Status Bar.



- 2 Select "Time Setting".

NOTE: On this screen, you can also adjust the clock format (12H or 24H) and, for vehicles with navigation, adjust the time zone and Daylight Saving Time. The recommended settings for these are "Auto."

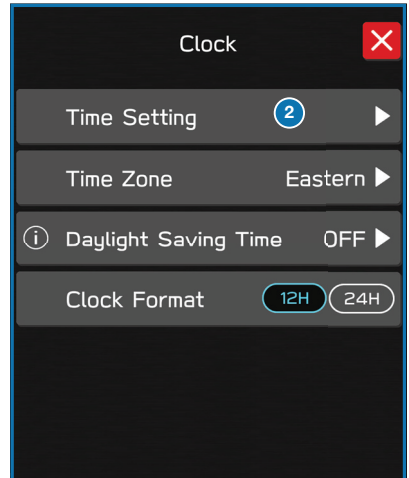

HOW TO APPENDIX

- 3 Select "Manual".
- 4 Adjust the time and date using the "Arrow Up" and "Arrow Down" buttons.
- 5 Once you are finished, select "OK".

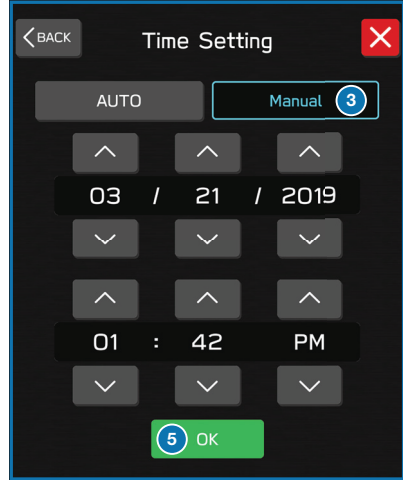

Automatically

To set the clock automatically:

- 1 Select the Clock Display in the Status Bar.



- 2 Select "Time Setting".

NOTE: On this screen, you can also adjust the clock format (12H or 24H) and, for vehicles with navigation, adjust the time zone and Daylight Saving Time. The recommended settings for these are "Auto."

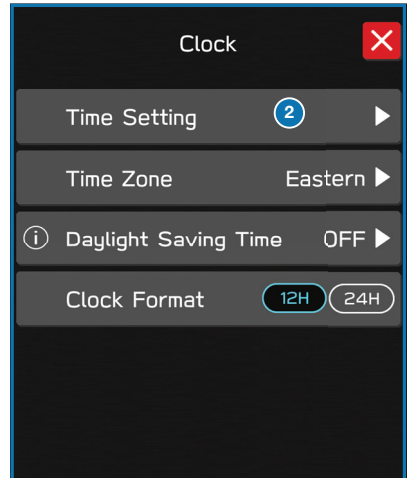

HOW TO APPENDIX

3 Select “Auto” or “Sync With Phone”.

4 Select “Back”.

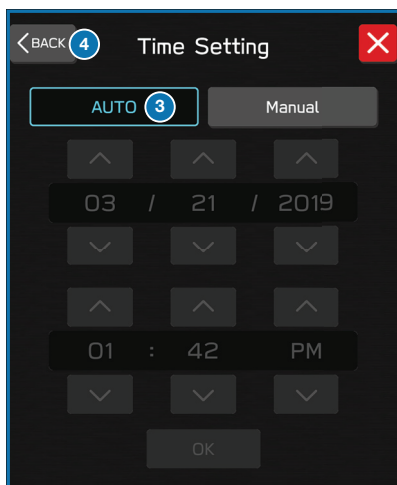

The clock automatically adjusts as follows:

- 11.6-inch display with navigation system: Automatically adjusts the clock when a GPS signal is available.
- 11.6-inch display without navigation system: Automatically adjusts the clock when a STARLINK® Safety and Security signal is available. Without STARLINK® Safety and Security, the clock automatically adjusts when a phone is paired and connected via Bluetooth®. “Phonebook Download” must be enabled in the Phone Settings.
- Dual 7.0-inch display: The clock automatically adjusts when a phone is paired and connected via Bluetooth®. “Phonebook Download” must be enabled in the Phone Settings.

For step-by-step procedure to pair a phone to the SUBARU STARLINK® Touchscreen, see page 84 for Android devices or page 91 for Apple devices in this Getting Started Guide.

MEMORY HEIGHT (if equipped)

With the Memory Height function, you can set where the Power Rear Gate stops when it opens. This is a great feature to limit the upward travel of the rear gate to ensure you can reach it or to prevent the rear gate from contacting a garage ceiling. You can learn more about setting the Power Rear Gate Memory Height from the how-to video linked in the QR code and the steps below.



Scan to learn how to set **Power Rear Gate Memory Height.**

To set the height:

- 1 On the Center Information Display (CID), press the “Home” Button.
- 2 Select “Settings”.
- 3 Navigate to the “Car” tab.
- 4 Find and select “Power Rear Gate”.

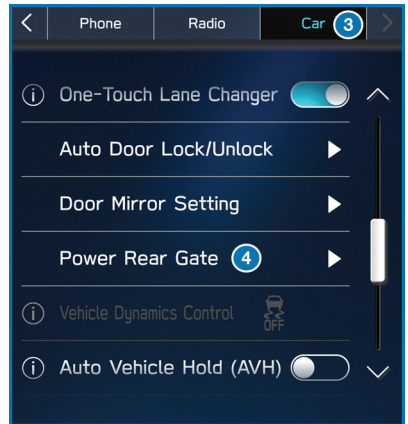

- 5 Turn off “Power Rear Gate Memory”.

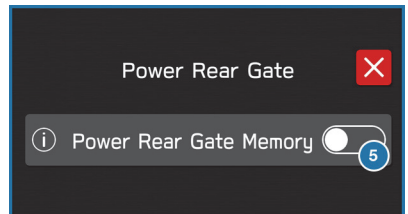

HOW TO APPENDIX

- 6** Open the rear gate using the Power Rear Gate Button. Pause the rear gate when it reaches the desired height by pressing the Power Rear Gate Button on the instrument panel, rear gate, or access key fob.

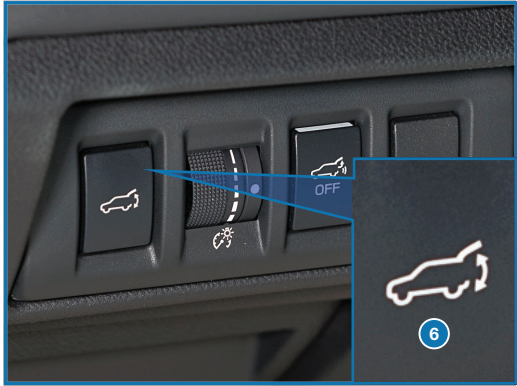

- 7** You can make gentle adjustments to the gate position by hand. With the rear gate at the desired height, press and hold the Power Rear Gate Close Button on the inside edge of the rear gate. A chirp sounds and the hazard warning lights flash to confirm the height is set. The Power Rear Gate memory is automatically saved and enabled in the Center Information Display (CID).



When “Power Rear Gate Memory” is enabled in the Center Information Display (CID), the rear gate will stop at the set memory height when you use any of the Power Rear Gate buttons.

NOTE: To adjust the memory height, perform the procedure again.

MEMORY DRIVER'S SEAT (if equipped)

You can set the seat and outside mirror position and retrieve them using the buttons on the driver's door or the access key fob. You can learn more about setting and retrieving your seat and mirror positions from the how-to video linked in the QR code and the following steps.



Scan to learn
how to set
**Memory Power
Seat and Mirrors.**

To set a seat position with a button:

1. Make sure the select lever is in the "P" position, with the parking brake applied and the ignition in the "ON" position.
2. Adjust your seat and outside mirrors to the desired position.
3. Register the position by either of the following procedures:
 - Press the "SET" button, and then press and hold either button "1" or "2". A chirp sounds when the position is registered.
 - While holding the "SET" button, press and hold either button "1" or "2". A chirp sounds when the position is registered.



Memory Seat Buttons

HOW TO APPENDIX

To retrieve the seat position set with a button:

1. Turn the ignition switch to “ON”.
2. Put the select lever in the “P” position and apply the parking brake. Then, press button “1” or “2”. The seat and outside mirrors are automatically recalled to your preferred positions.

To set a seat position with the access key fob:

1. Make sure the select lever is in the “P” position with the parking brake applied and the ignition “OFF”.
2. Adjust your seat and outside mirrors to the desired position.
3. While holding the “SET” button, press and hold the unlock button on the access key fob. A chirp sounds when the position is registered.

To retrieve the seat position set with the access key fob:

1. Hold the access key fob.
2. Unlock and open the driver’s door. The seat and outside mirrors are automatically recalled to your preferred positions.

WI-FI

Connecting to a Wi-Fi Network (Navigation Models Only)

- 1 On the Home Screen, select “Settings”.
- 2 In the “General” settings menu, select “Wi-Fi Settings”.



- 3 Make sure that Wi-Fi is enabled, then select “Available Wi-Fi Networks”.



HOW TO APPENDIX

- 4 Select the desired network. When selecting a network with the lock icon, a screen will appear for you to enter the password, then select OK.

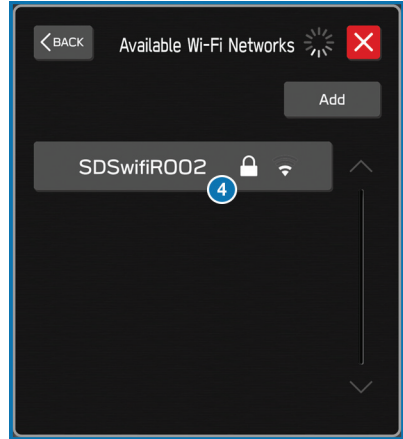

Wi-Fi Hotspot Subscription (if equipped)

Internet access is purchased separately through AT&T with monthly, per gigabyte, and unlimited data options available. Existing AT&T customers have the option to add an additional line to their AT&T Mobile Share plan. Available on select models.

Shortly after you take delivery of your new Subaru, you will receive an email from AT&T for a one month free trial and how to activate your free trial. To set up and enroll:

1. Select “Settings” on the Home screen.
2. Select “Wi-Fi Hotspot” to turn it on (if the Wi-Fi Hotspot is already on then proceed to the next step).
3. Select Wi-Fi Hotspot Settings to view or update the following settings:
 - Wi-Fi Network Name (SSID)
 - SSID Broadcast (Network ON / OFF)
 - Security Type (WPA / WPA2)
 - Password
 - Connected Devices (Maximum of 8 devices)
 - Broadcast Frequency

How to enroll:

1. Connect your tablet, smartphone or laptop to the SUBARU STARLINK® Wi-Fi Hotspot network listed in the settings menu and open your preferred web browser on the device connected.
2. Once the SUBARU STARLINK® Wi-Fi Hotspot homepage loads, follow the on-screen instructions to create a new account or to add your vehicle to an already existing AT&T Wireless account. You can also subscribe to the Wi-Fi Hotspot from the MySubaru website or Mobile App.

 You can also visit an AT&T store or their website for more information at:

<https://www.att.com/plans/connected-car/subaru.html>



Scan to learn
more about
AT&T plans

HOW TO APPENDIX

MAPS (if equipped)

Creating Home/Work

You can create a home address and work address through the Map screen:

- 1 Select the Map button on the home screen to display the map.



- 2 Select the Menu button.

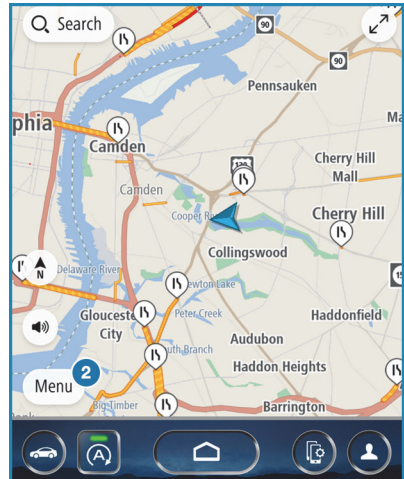

HOW TO APPENDIX

- 3 Select the Add Home or Add Work button.

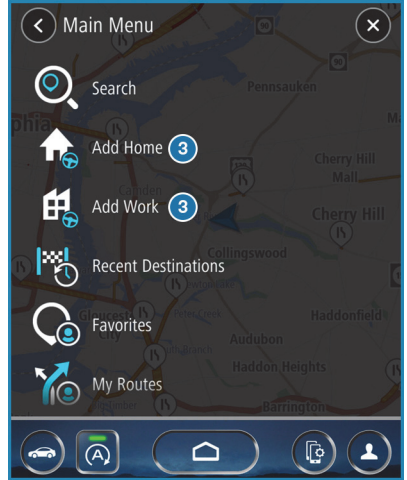

- 4 Use the keypad to enter the address. Results will be listed below. Select the address once it is displayed.

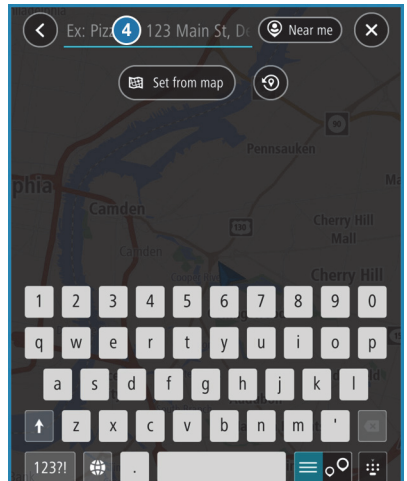

HOW TO APPENDIX

- 5 Select the Home or Work icon to save the location as home or work.

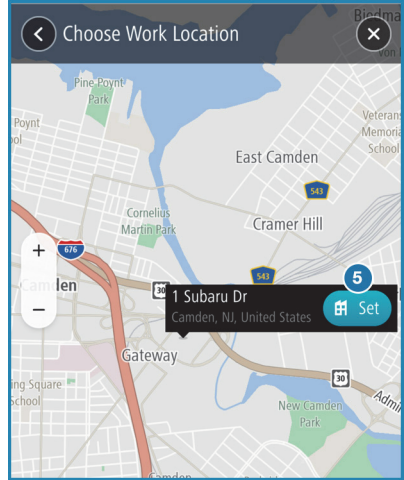

Searching for a Destination

Follow these steps to search for a destination:

- 1 Select the Map button on the home screen to display the map.



HOW TO APPENDIX

- 2 Select the search button to begin your search.

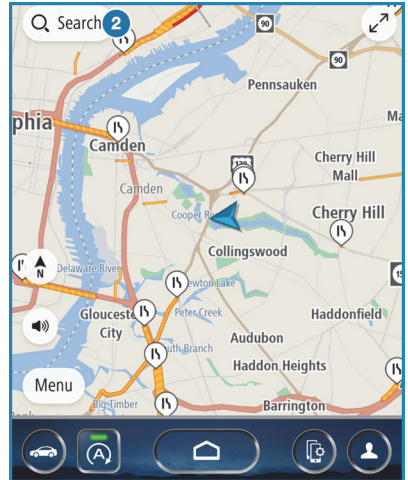

- 3 Use the keypad to enter the address or search by name/category (e.g., restaurant or park). Results will be listed below. Scroll, if needed, to find the address/destination, and select it.

- Selecting “Near Me” allows you to set the search radius filter. Once the filter is set, the search will only be performed for items within the chosen option: Whole Map, Near Me, In Town or City, Along Route, Near Destination, or Latitude/Longitude. You may need to change the setting if your destination is beyond the scope of the search radius filter.
- Selecting the “X” will exit the search and display the current vehicle location on the map.



HOW TO APPENDIX

- 4 Select “Go” when the destination appears on the map.

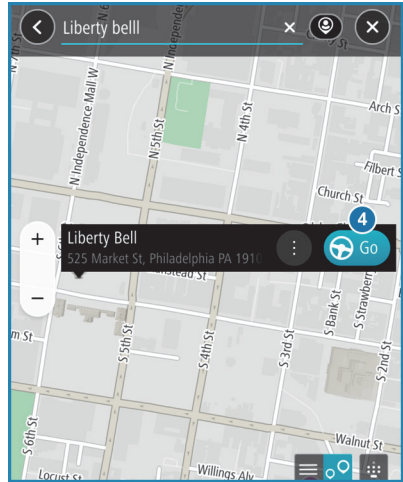

- 5 Three route options are provided for your destination. Choose your preferred route and Select “Go” to begin route guidance.

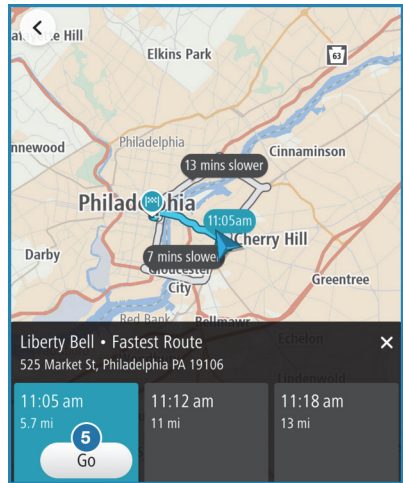

Finding a Location with What3Words

Follow these steps to search for a destination:

- 1 First, using your phone or computer, select your desired location in the What3Words website/app, which displays the three corresponding words.

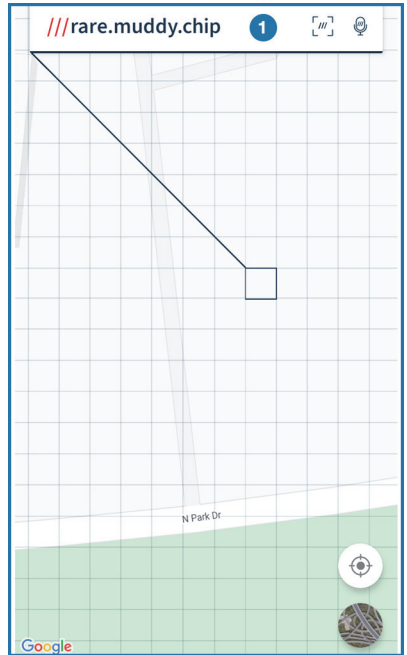

- 2 Next, open the map screen in the Center Information Display and select the Search button.

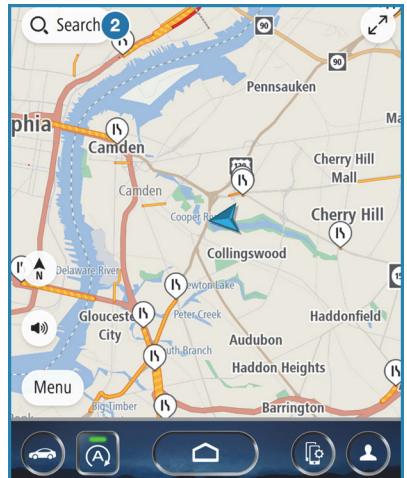

HOW TO APPENDIX

- 3 Use the keypad to enter the three words, separated by periods, associated with your location. Results will be listed below. Select the location.



- 4 Select "Go" when the location appears on the map.

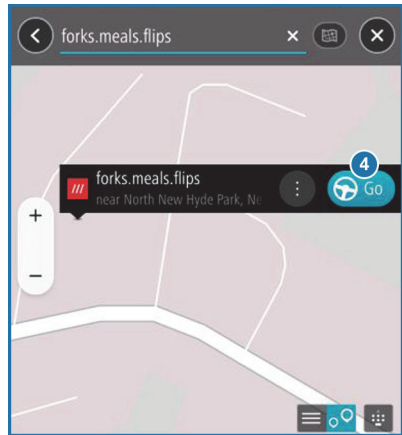

- 5 Three route options are provided for your destination. Choose your preferred route and Select “Go” to begin route guidance.

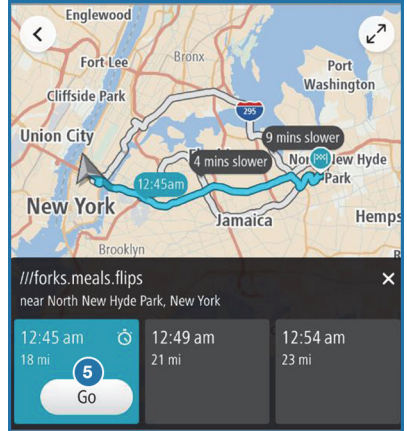

Route Options

You can set the navigation system to avoid certain types of routes:

- 1 On the home screen select “Settings”, then “Navigation”.
- 2 Select “Avoid”.

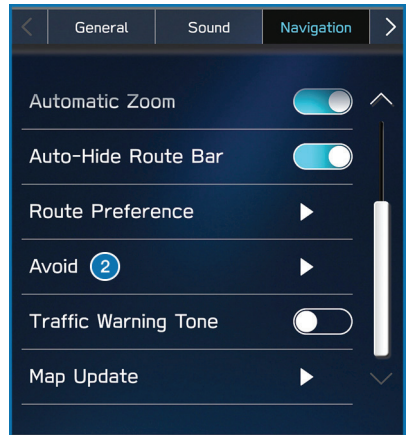

HOW TO APPENDIX

- 3 Select the desired item to avoid.

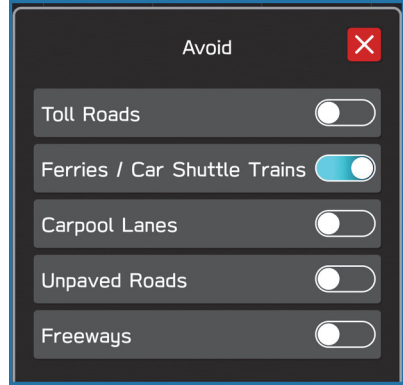

Route Preference

You can set the route preferences to search for the route that is fastest, shortest, or most eco-friendly:

- 1 On the home screen, select "Settings".
- 2 Select "Navigation".
- 3 Select "Route Preference".

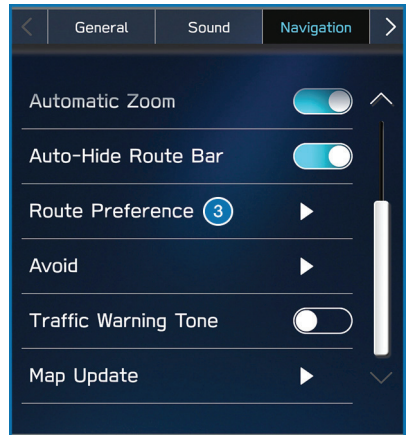

HOW TO APPENDIX

- 4 Select your route search preference.

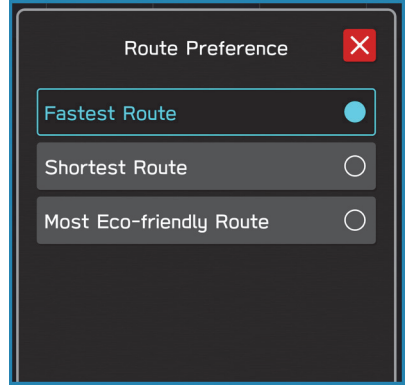

Saving Destination as a Favorite

The registered points can be set as a destination. To save a location from the Map screen:

- 1 Select the Menu button.

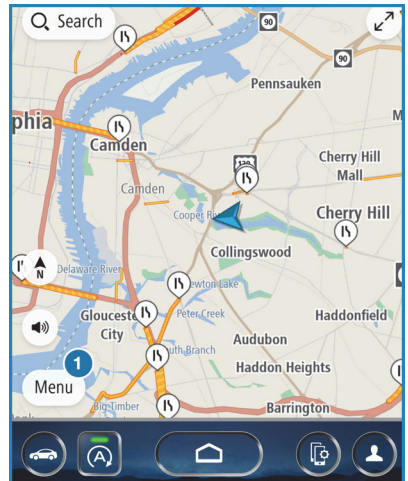

HOW TO APPENDIX

- 2 Select the Favorites button.

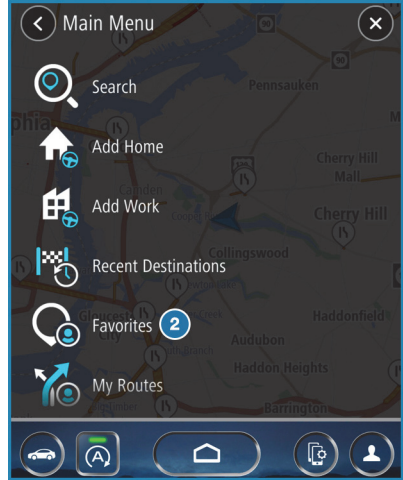

- 3 Select "Add".

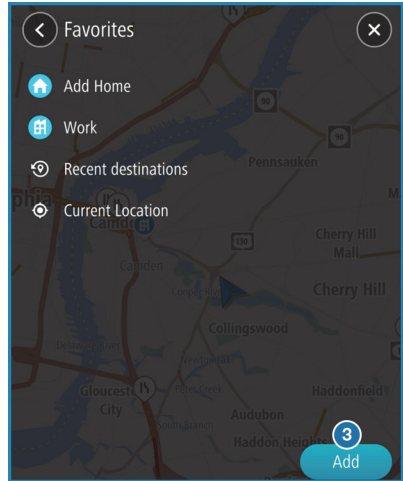

HOW TO APPENDIX

- 4 Type the address or name of the place you want to save. Results begin to appear below as you type. Select the address when it appears.

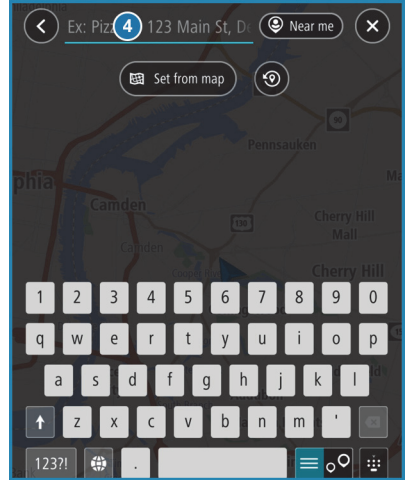



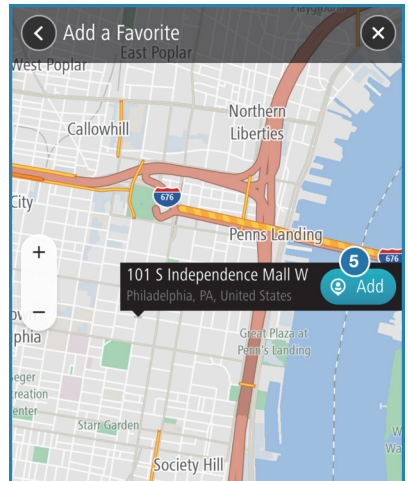







- 5 Select the icon on the address to save to favorites. You can rename the location or use the address as the location name. Select OK when finished.



HOW TO APPENDIX

Guidance Screen Icons

These are the common icons used for the navigation guidance.

ICON	EXPLANATION	ICON	EXPLANATION
	Turn left/right.		Go straight ahead at the intersection.
	U-turn.		Exit at the junction.
	Keep left/right at the fork in the road.		Roundabout.
	Turn left/right & sharp curve.		You have arrived at your destination.
	Stay in the left/right lane.		You have arrived at your waypoint.

Map Zoom

You can zoom in or out on the map by “pinching-in” or “pinching-out.” Place two fingers on the screen and move them apart to zoom in. Place two fingers on the screen and move them closer together to zoom out. You can also zoom in or out on the map by tapping anywhere on the map, and then selecting the “+” or “-” buttons.

You can enlarge the map to cover the top portion of the screen by selecting the full screen button in the corner.

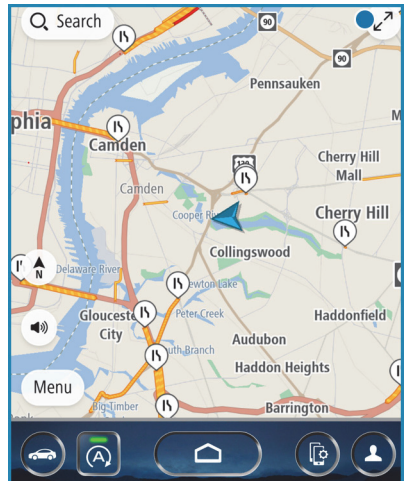
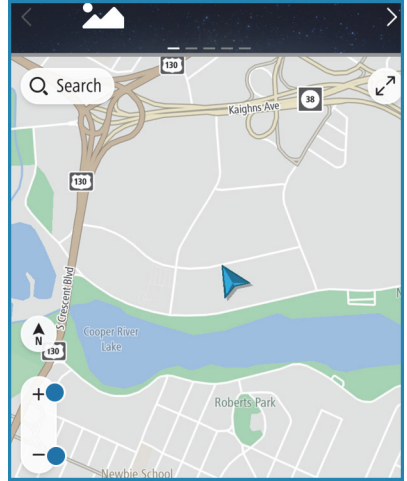

HOW TO APPENDIX

Map View/Perspectives

The orientation of the map can be changed between 2D north-up, 2D heading-up, and 3D heading-up. To change the view, select the map view icon. Each time the icon is touched, the view will change. The direction of the arrow indicates north when in 2D heading-up and 3D heading-up modes.

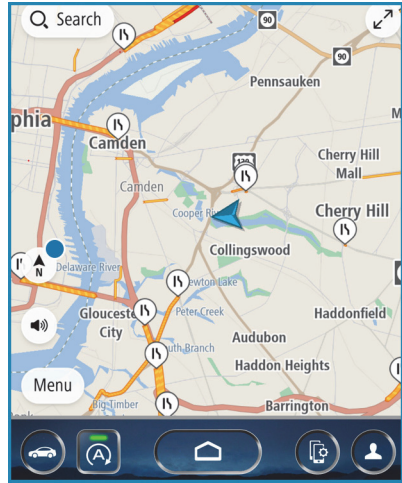

Traffic Information

Road sections affected by traffic conditions are displayed in a different color on the map, and a small icon representing the type of traffic condition is displayed above the road.

To receive the data service information in the vehicle, a subscription to the SiriusXM® Traffic Services is required following a free trial.

Nearest Gas Station

When driving on the highway during route guidance, information on gas stations, restaurants, or rest areas will be displayed on the right.

Select the desired item from the list, and then select “Add Stop” to add to your current trip. Select “GO” to change your destination to the new item.

Arrival Distance / Time

Displays the distance to the destination and/or the estimated arrival time at the destination.

This is customizable by selecting “Settings” on the home screen, then “Navigation” and finally “Arrival Distance / Time”.

Canceling Guidance

To cancel guidance, select “End”.

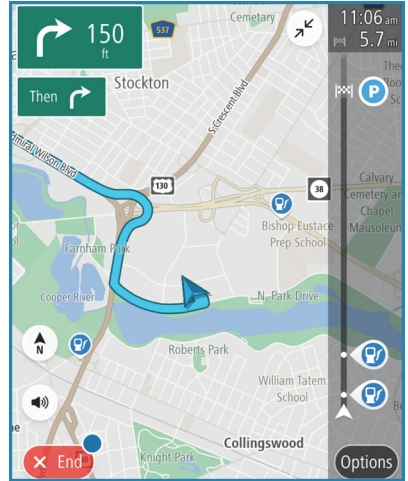

Map Updates

For vehicles with the 11.6 Multimedia Navigation system, the maps can be updated over a Wi-Fi network, either manually or automatically.

1 For more information, please refer to “Navigation System (if equipped)” in your STARLINK® Owner’s Manual.

To update your maps automatically over Wi-Fi, follow this process:

- 1** First, make sure you are connected to a Wi-Fi Network (see page 147). Return to “Settings”, and then select the “Navigation” menu.
- 2** Select “Map Update”, select “Wi-Fi” and then select “Automatic Update”.



HOW TO APPENDIX

- 3 Select “Update maps automatically (at most 8 maps can be selected)” and then select the regions you would like to update.

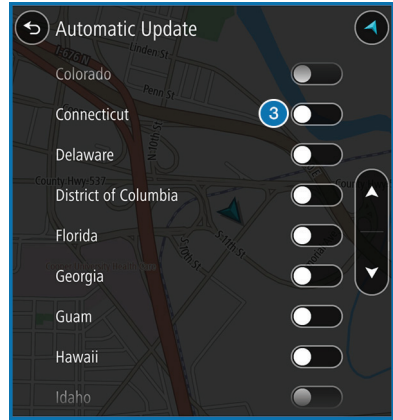

After the updates have been completed, turn the ignition switch to the “LOCK” / “OFF” position and exit the vehicle. Close the driver’s door and lock the doors. Then, move at least 10 feet away from the vehicle to prevent the key from interfering. After at least five minutes have elapsed, start the engine again. The new map data will be applied.

2.4L TURBO ENGINE 58
 2.5L ENGINE 57

A

ACCESSORY CONNECTIONS 39
 ADDING SHORTCUTS 70
 ADVANCED ADAPTIVE CRUISE
 CONTROL 19
 AUDIO CONTROLS 18
 AUTO START-STOP 42

B

BLIND SPOT DETECTION (BSD) / REAR
 CROSS TRAFFIC ALERT (RCTA) . . 126
 Blind Spot Detection (BSD) 126
 Blind Spot Detection / Rear Cross
 Traffic Alert OFF 127
 Lane Change Assist (LCA) 126
 Rear Cross Traffic Alert (RCTA) . . 126
 BUTTONS 65
 Controlling the Volume 65

C

CARGO COVER 54
 CENTER CONSOLE STORAGE 31
 CHILD SAFETY LOCKS 52
 CLIMATE CONTROL 33
 11.6-Inch Automatic Climate
 Control 34
 Dual 7-Inch Automatic Climate
 Control 33
 Heated Seats 37
 Heated Steering Wheel 38
 Rear Heated Seats 38
 Remote Engine Start with Climate
 Control 37
 Ventilated Seats 38

CLOCK 111
 COMBINATION METER 16
 CREATING A DRIVER PROFILE 72
 Retrieving a Driver Profile 75

D

DRIVERFOCUS® COMPONENTS . . . 130
 Camera 130
 Center Information Display (CID) . . 131
 Combination Meter Display (CMD) . . 131
 DRIVERFOCUS® OVERVIEW 130
 DRIVER MONITORING SYSTEM OFF . . 134
 DRIVER PROFILE/CONVENIENCE
 SETTINGS 132
 Deleting a Driver 133
 Recognizing a Driver 133
 Registering a Driver 132
 DRIVING THE VEHICLE 41
 Automatic Transmission Shift Mode . . 41
 Paddle Shift Control Switches 41
 DROWSY/INATTENTIVE WARNINGS . . 132

E

ELECTRONIC PARKING BRAKE (EPB) . . 44
 Auto Vehicle Hold (AVH) 45
 ENGINE OIL SPECIFICATIONS &
 CAPACITIES 59
 ENROLLMENT 105
 EYESIGHT® DISCLAIMER 137
 EYESIGHT® OVERVIEW 112
 EYESIGHT® ASSIST MONITOR
 (EAM) 121

F

FOLDING THE REAR SEATS 51
 FRONT VIEW MONITOR 125
 FUEL FILLER LID 50
 FUEL SPECIFICATIONS AND
 CAPACITY 50

INDEX

FUNCTIONS	113
Advanced Adaptive Cruise Control with Lane Centering	117
Automatic Emergency Steering	114
Conventional Cruise Control	118
Lane Departure Prevention	116
Lane Departure Warning	115
Lane Sway Warning	116
Lead Vehicle Start Alert	119
Pre-Collision Brake Assist	114
Pre-Collision Braking	114
Pre-Collision Throttle Management	115

H

HIGH BEAM ASSIST (HBA)	128
HOME SCREEN ICONS	69
HOOD PROP	56
HOW TO OVERVIEW	138

I

IGNITION SWITCH	40
IMPORTANT SAFETY INFORMATION	4
IN CASE OF EMERGENCY	5
Subaru Roadside Assistance	5
SUBARU STARLINK® Safety and Security (if equipped, subscription required)	5
INSTRUMENT PANEL SWITCHES (LOWER LEFT)	18
i SWITCH	19

K

KEYLESS ACCESS WITH PUSH BUTTON	
START	8
Locking Using Door Handles	8
Locking Using the Rear Gate	9
Unlocking Using Door Handles	8
Unlocking Using the Rear Gate	9
KEYLESS ENTRY	7
Automatic Door Locking/Unlocking	7

L

LANE DEPARTURE WARNING AND PRE-COLLISION BRAKING SYSTEM	
OFF	122
Lane Departure Warning OFF	122
Pre-Collision Braking System OFF	123
LATCH/ANCHOR	52
LIGHT CONTROLS	20
Daytime Running Lights	21
Illumination Brightness	20

M

MAKING A CALL	97
MAPS	150
Arrival Distance / Time	164
Canceling Guidance	165
Creating Home/Work	150
Finding a Location with What3Words	155
Guidance Screen Icons	162
Map Updates	165
Map View/Perspectives	164
Map Zoom	163
Nearest Gas Station	164
Route Options	157
Route Preference	158
Saving Destination as a Favorite	159
Searching for a Destination	152
Traffic Information	164
MAPS/NAVIGATION	109
Checking for Map Updates	110
Updating Maps Using Your PC/MAC	110
Updating Over-the-Air	110
MAPS OVERVIEW	103
What3words	103
MEDIA	82
AUX Input	82
Bluetooth®	82
CD	82
USB / iPod	82

MEMORY DRIVER'S SEAT 145
 MEMORY HEIGHT 143
 MYSUBARU 101
 Service Appointment Scheduler . . . 102
 MYSUBARU INTEGRATION 105

N

NEW VEHICLE BREAK-IN 59

O

OPERATION 113
 OVERHEAD CONSOLE 23
 OVERVIEW OF YOUR MULTIMEDIA
 SYSTEM 63
 Screen Layout 64
 Various Systems 63
 OWNER'S RESOURCES 4

P

PAIRING AN ANDROID PHONE 84
 Android Auto Best Practices 89
 Android Auto Compatible Models and
 Cables 90
 Bluetooth® Pairing and Android
 Auto 84
 PAIRING AN iPhone 91
 Apple CarPlay Best Practices 96
 Bluetooth® Pairing and Apple
 CarPlay 91
 iPhone Compatible Models and
 Cables 96
 PAIRING A PHONE 83
 PHONE 109
 POWER EXTERIOR MIRRORS 27
 Power Folding Mirrors 28
 Reverse Tilt Mirror 29
 POWER MOONROOF 32
 Opening/Closing the Moonroof . . . 32
 Tilting the Moonroof 32

POWER REAR GATE (PRG) 10
 From the Rear of the Vehicle 11
 Hands-free Power Rear Gate 12
 Power Rear Gate Button 10
 Power Rear Gate Lock 12
 POWER WINDOWS 31
 PUSH-BUTTON IGNITION SWITCH . . . 40

R

RADIO 80
 AM/FM Radio 80
 Presets 81
 Satellite Radio 81
 REARRANGING ICONS 70
 REAR SEAT REMINDER 53
 Passenger Occupant Detection and
 Seatbelt Reminders 53
 REAR VIEW MIRROR 29
 Auto-dimming Mirror 29
 HomeLink® 5 Accessory Mirror . . . 30
 Smart Rearview Mirror 30
 REAR-VISION CAMERA 124
 Rear-vision Camera Washer 124
 REAR WINDOW WIPER 22
 Rear-vision Camera Washer 22
 RECEIVING A CALL 98
 REVERSE AUTOMATIC BRAKING
 (RAB) 129
 Reverse Automatic Braking (RAB)
 OFF 129
 ROOF RAIL / CROSS BAR CAPACITY . . 60

S

SAFETY AND SECURITY
 OVERVIEW 104
 SEATING 24
 Head Restraint Adjustment 26
 Manual Seats 24
 Power Driver's Seat (if equipped) . . 25
 Seatbelt Adjuster 26

INDEX

SETTINGS AND UPDATES	
OVERVIEW	107
Connect to Home Wi-Fi (Navigation Models Only)	107
SETTING THE CLOCK 138	
Automatically	141
Manually	139
SOUND 108	
SPARE TIRE 55	
STARTING THE VEHICLE 40	
Without Push-button Ignition	40
With Push-button Ignition	40
STEERING RESPONSIVE HEADLIGHTS (SRH) 128	
STEERING WHEEL CONTROLS 67	
Advanced Adaptive Cruise Control	119
Customizing EyeSight® Settings	120
STEREO CAMERA PRECAUTIONS 135	
SUBARU STARLINK® IN-VEHICLE	
APPS	100
Android Auto™	100
Apple CarPlay®	100
SiriusXM® Travel Link	101
SUBARU STARLINK® WI-FI	
HOTSPOT	106

T

V	
VALET MODE 75	
Activating Valet Mode	76
Deactivating Valet Mode	78
VOICE RECOGNITION 67	
Common Commands	68
Tips	67

W

WARNING AND INDICATOR LIGHTS 17	
WELCOME 4	
WI-FI 147	
Connecting to a Wi-Fi Network	147
Wi-Fi Hotspot Subscription (if equipped)	149
WINDSHIELD GLASS AND DASHBOARD 135	
WINDSHIELD WIPERS 21	

X

X-MODE® 46	
Hill Descent Control (HDC)	48

NOTES

Subaru of America, Inc.
One Subaru Drive
Camden, NJ 08103-9800



MSA5B2404A
Issued March 2023
Printed in USA 03/23

