

Getting Started Guide
WRX
WRX STI
2021



Love. It's what makes Subaru, Subaru.



© 2020 Subaru of America, Inc. Printed in USA. All rights reserved. Contents may not be reproduced in whole or in part without prior written permission of publisher. Specifications in this Guide are based on the latest product information available at the time of publication. Some images shown are for illustration purposes only. Some equipment shown in photography within this Guide is optional at extra cost. Specific options may be available only in combination with other options. Specific combinations of equipment or features may vary from time to time, and by geographic area. Subaru of America, Inc. reserves the right to change or discontinue at any time, without notice: Prices, colors, materials, equipment, accessories, specifications, models and packages, without incurring any obligation to make the same or similar changes on vehicles previously sold. Colors shown may vary due to reproduction and printing processes. Subaru of America, Inc. is not responsible for typographical errors. Aha™ is a trademark of Harman International Industries, Incorporated. Alcantara® is a registered trademark of Alcantara S.p.A., and Alcantara is produced by the Toray Group. App Store® is a registered trademark of Apple, Inc. Apple® is a registered trademark of Apple, Inc. Apple CarPlay® is a registered trademark of Apple, Inc. Android Auto™ is a trademark of Google, LLC. BBS® is a registered trademark of BBS Kraftfahrzeugtechnik, AG. Bluetooth® is a registered trademark of Bluetooth SIG, Inc. Brembo® is a registered trademark of Freni Brembo, S.p.A. GreenEdge® is a registered trademark of Harman International Industries, Incorporated. Glympse® is a registered trademark of Glympse, Inc. Grand Luxe® is a registered trademark of Seiren Co., Ltd. HARMAN® is a registered trademark of HARMAN International Industries, Incorporated. Harman Kardon® is a registered trademark of Harman International Industries, Incorporated. Quantum logic™ is a trademark of Harman International Industries, Incorporated. HD Radio® is a registered trademark of iBiquity Digital Corporation. HomeLink® and the HomeLink® house icon are registered trademarks of Gentex Corporation. iHeartRadio® is a registered trademark of iHeartMedia, Inc. iPod® is a registered trademark of Apple, Inc. iTunes® is a registered trademark of Apple, Inc. Magellan® is a registered trademark of MiTAC International Corporation. Michelin® is a registered trademark of Compagnie Générale des Etablissements Michelin. Metal-Matrix Diaphragm (MMD®) is a registered trademark of Harman International Industries, Incorporated. MirrorLink™ is a trademark of Car Connectivity Consortium, LLC. Pandora® is a registered trademark of Pandora Media, Inc. SACHS® is a registered trademark of ZF Friedrichshafen AG. Siri® is a registered trademark of Apple, Inc. Smart Way® is a registered trademark of the U.S. Environmental Protection Agency. Stitcher™ is a trademark of Stitcher™, Inc. TomTom® is a registered trademark of TomTom International BV. TORSEN LSD® is a registered trademark of JTEKT TORSEN North America, Inc. SiriusXM® All Access Radio is a registered trademark of Sirius XM Radio, Inc. SiriusXM Traffic® is a registered trademark of Sirius XM Radio, Inc. SiriusXM Travel Link® is a registered trademark of SiriusXM Radio, Inc. Ultrasuede® is a registered trademark of Toray Industries, Inc. Yelp® is a registered trademark of Yelp, Inc. Ascent, DriverFocus, and StarDrive, are trademarks of Subaru of America, Inc. Added Security, Crosstrek, Forester, Outback, StarTex and XV Crosstrek are registered trademarks of Subaru of America, Inc. BRZ, Confidence in Motion, EyeSight, Impreza, Lineartronic, Legacy, S209, Subaru, SUBARU STARLINK®, SUBARU BOXER, tS (Design), WRX, STI and X-MODE are registered trademarks of Subaru Corporation.

TABLE OF CONTENTS



PURPOSE OF THIS GUIDE

WELCOME	4
IMPORTANT SAFETY INFORMATION	4
OWNER'S RESOURCES	4
IN CASE OF EMERGENCY	5
TOWING YOUR ALL-WHEEL DRIVE SUBARU	6

ENTRY AND EXIT

KEYLESS ENTRY	7
KEYLESS ACCESS WITH PUSH BUTTON START	8

INSTRUMENT PANEL

GETTING COMFORTABLE

SEATING	12
TILT AND TELESCOPIC STEERING COLUMN	14
POWER EXTERIOR MIRRORS ..	14
REAR VIEW MIRROR	15
POWER WINDOWS	16
POWER MOONROOF	17
CLIMATE CONTROL	18
ACCESSORY CONNECTIONS ..	23

CONTROLS

INSTRUMENT PANEL SWITCHES (LOWER LEFT)	24
AUDIO CONTROLS	24
CRUISE CONTROL	25

ADAPTIVE CRUISE CONTROL ..	25
I/SET SWITCH	26
ENTER SWITCH	26
LIGHT CONTROLS	27
TURN SIGNALS	28
WINDSHIELD WIPERS	28
OVERHEAD PANEL	29

GAUGES AND WARNING LIGHTS

COMBINATION METER	31
WARNING AND INDICATOR LIGHTS	31

OPERATING THE VEHICLE

IGNITION SWITCH	32
PUSH-BUTTON IGNITION SWITCH	32
STARTING THE VEHICLE	32
DRIVING THE VEHICLE	33
ELECTRONIC PARKING BRAKE (EPB)	37
TURNING OFF THE VEHICLE ..	39

REFUELING

FUEL FILLER LID	40
FUEL	40
FUEL CAPACITY	40

PASSENGER/CARGO AREAS

FOLDING THE REAR SEATS ..	41
CHILD SAFETY LOCKS	41

TABLE OF CONTENTS

LATCH/ANCHOR	42	MYSUBARU	68
INTERNAL SAFETY TRUNK RELEASE WITH SELF- ILLUMINATING HANDLE	42	MAPS (if equipped) MAPS OVERVIEW	69
SPARE TIRE AND JACK	43	CREATING HOME AND WORK PROFILES	69
ENGINE COMPARTMENT 2.0 L ENGINE (WRX)	44	STARLINK SAFETY AND SECURITY SAFETY AND SECURITY OVERVIEW	70
2.5 L ENGINE (WRX STI)	45	ENROLLMENT	71
ADDITIONAL SPECIFICATIONS NEW VEHICLE BREAK-IN	46	MYSUBARU INTEGRATION	72
ENGINE OIL	46	SUBARU STARLINK® WI-FI HOTSPOT	72
ENGINE OIL CAPACITY	46	SETTINGS AND UPDATES SETTINGS AND UPDATES OVERVIEW	73
ROOF RAIL CAPACITY	47	SOUND	74
TRAILER TOWING CAPACITY ..	47	PHONE	74
TIRE PRESSURE MONITORING SYSTEM (TPMS)	48	MAPS/NAVIGATION	75
STARLINK OVERVIEW OVERVIEW OF YOUR MULTIMEDIA SYSTEM	49	CLOCK	77
BUTTONS	49	EYESIGHT EYESIGHT® OVERVIEW	78
TOUCHSCREEN	51	OPERATION	78
STEERING WHEEL CONTROLS	52	FUNCTIONS	79
VOICE RECOGNITION	53	STEERING WHEEL CONTROLS	84
STARLINK HOME HOME SCREEN ICONS	55	EYESIGHT® ASSIST MONITOR (EAM)	85
REARRANGING ICONS	55	LANE DEPARTURE WARNING AND PRE-COLLISION BRAKING SYSTEM OFF SWITCHES	86
ADDING SHORTCUTS	56	DRIVER ASSIST TECHNOLOGIES REAR-VISION CAMERA	87
DRIVER PROFILE CREATING A DRIVER PROFILE ..	57	BLIND-SPOT DETECTION (BSD)/ REAR CROSS-TRAFFIC ALERT (RCTA)	87
MULTIMEDIA RADIO	59	HIGH BEAM ASSIST (HBA)	88
MEDIA	60	STEERING RESPONSIVE HEADLIGHTS (SRH)	88
PHONE PAIRING A PHONE	61	REVERSE AUTOMATIC BRAKING (RAB)	89
MAKING A CALL	61		
RECEIVING A CALL	62		
TEXT MESSAGES	63		
APPS SUBARU STARLINK® IN-VEHICLE APPS	64		
SUBARU STARLINK® MOBILE APP	66		

TABLE OF CONTENTS

CARE AND LIMITATIONS	
STEREO CAMERA	
PRECAUTIONS	90
WINDSHIELD GLASS AND	
DASHBOARD	90
FRONT VIEW	
WRX/STI	91
EYESIGHT DISCLAIMER	
EYESIGHT® DISCLAIMER	92
HOW TO APPENDIX	
HOW TO OVERVIEW	93
BLUETOOTH® PAIRING	93
ANDROID AUTO™	101
APPLE CARPLAY®	103
WI-FI	105
MAPS	107
FIRMWARE AND SOFTWARE	
UPDATES	115
INDEX	116

PURPOSE OF THIS GUIDE

WELCOME

Congratulations on choosing a Subaru WRX/WRX-STI and welcome to the Subaru family!

Subaru is more than a car company™. We are committed to making the world a better place, and the Subaru Love Promise is our vision to show love and respect to all people at every interaction with Subaru. We believe in building lifelong relationships with our customers, earning your trust and exceeding your expectations by providing customer service with integrity and compassion.

This Getting Started Guide will introduce you to your new Subaru WRX/WRX-STI by providing information on the basic operation and key features of your Subaru as well as the STARLINK® and EyeSight® systems in your vehicle.

IMPORTANT SAFETY INFORMATION

The Getting Started Guide is not intended as a substitute for the Owner's Manuals. We strongly encourage you to review the vehicle, STARLINK®, and EyeSight® Owner's Manuals to ensure complete understanding.

OWNER'S RESOURCES

If you're having difficulty using any of the functions outlined in this guide, or to learn more, you can get more information from the following sources:

Your Subaru Owner's Manuals:

Located in the glovebox

Online Subaru Owner's Resources:

www.subaru.com/owners

Subaru Customer Support:

www.subaru.com/customer-support

1-800-782-2783 (1-800-SUBARU3)



Scan to learn more about Owner's Resources.



Scan to learn more about Customer Support.



Scan to get the **MySubaru** App.



Scan to get the **SUBARU STARLINK®** App.

PURPOSE OF THIS GUIDE

IN CASE OF EMERGENCY

SUBARU STARLINK® Safety and Security (subscription required)

SOS Emergency: Press the red “SOS” button on the overhead console in the event of an emergency to speak with a SUBARU STARLINK® Customer Care Advisor.

Enhanced Roadside Assistance: Press the blue “i” button on the overhead console or select the “Roadside Assistance” option in the “MySubaru” menu on the multimedia system.



SOS and Roadside Assistance Buttons

i For more information, please refer to “Safety and Security Overview” on page 70 or the SUBARU STARLINK® Safety and Security Owner’s Manual.

Subaru Roadside Assistance

Subaru Roadside Assistance:

1-800-261-2155

Subaru Roadside Assistance is free and standard on your Subaru; there are no forms to complete. This service is available anytime during the 3-year/36,000-mile Subaru Limited Warranty, whichever comes first. See your retailer for details and refer to the Roadside Assistance guide in the owner’s information kit for the details on this coverage. A Subaru Roadside Assistance decal has been affixed to the driver’s door window.

Roadside assistance helps with:

- Towing to the nearest authorized Subaru retailer if you cannot safely drive your Subaru
- Jump-start if your battery is dead
- Gasoline delivery if you run out of gas
- Flat tire change to install your spare
- Emergency lockout service
- National Subaru retailer locator service, with phone numbers and location of the nearest retailer anywhere in the U.S. or Canada

NOTE: Specifically excluded from Subaru Roadside Assistance coverage are service requests or claims resulting from: accidents, vandalism, acts of God, violation of any laws, or vehicle modifications not recommended by the manufacturer.

PURPOSE OF THIS GUIDE

TOWING YOUR ALL-WHEEL DRIVE SUBARU

Since Subaru Symmetrical All-Wheel Drive distributes power to all four wheels, improper towing may damage your AWD system. The best way to tow your WRX/STI is with a flatbed truck by your Subaru retailer or a commercial towing service.

KEYLESS ENTRY

1 Lock/Arm

- Press the lock/arm button to lock the doors and trunk and to activate the security alarm. A chirp sounds and the hazard warning lights flash once.
- If any of the doors or the trunk are not fully closed, five rapid chirps sound and the hazard warning lights will flash to alert you.
- Press the lock/arm button three times to activate the vehicle finder function. If you are within 30 feet of your Subaru, the horn sounds once, and the hazard warning lights flash three times.

2 Unlock/Disarm

- Press the unlock/disarm button once to unlock the driver's door. To unlock all the doors and the trunk, briefly press the button twice. Two chirps sound and the hazard warning lights flash twice.
- The interior lights will illuminate when you press the unlock/disarm button if they are set to the "DOOR" position on the overhead console.

3 Trunk

- Press and hold the trunk button to open the trunk.

4 Panic Alarm

- Press the panic alarm button to sound the horn and flash the hazard warning lights.
- Press any button on the access key fob or transmitter to deactivate the panic alarm.



Transmitter



Access Key Fob

ENTRY AND EXIT

KEYLESS ACCESS WITH PUSH BUTTON START

(if equipped)

The Keyless Access with Push-Button Start system features touch-activated door locking or unlocking and push-button start functions without the key ever leaving your pocket or purse. You can customize the touch-activated door locking or unlocking settings in the Multi-Function Display. Operate the ENTER button to navigate to “Car Setting” then “Keyless Access Settings”.

Unlocking Using Door Handles

Grip the driver’s door handle to unlock the driver’s door (or all doors depending on the setting). Grip the front passenger’s door handle to unlock all doors and the trunk. Two chirps sound and the hazard warning lights flash twice.



Door Unlock Sensor

Locking Using Door Handles

Close all the doors and the trunk and touch the door lock sensor (two lines) on either front door handle. All doors and the trunk lock. One chirp sounds and the hazard warning lights flash once.



Door Lock Sensor

Unlocking the Trunk

Press the trunk opener button to unlock and open the trunk. Two chirps sound and the hazard warning lights flash twice.



Trunk Opener Button

INSTRUMENT PANEL

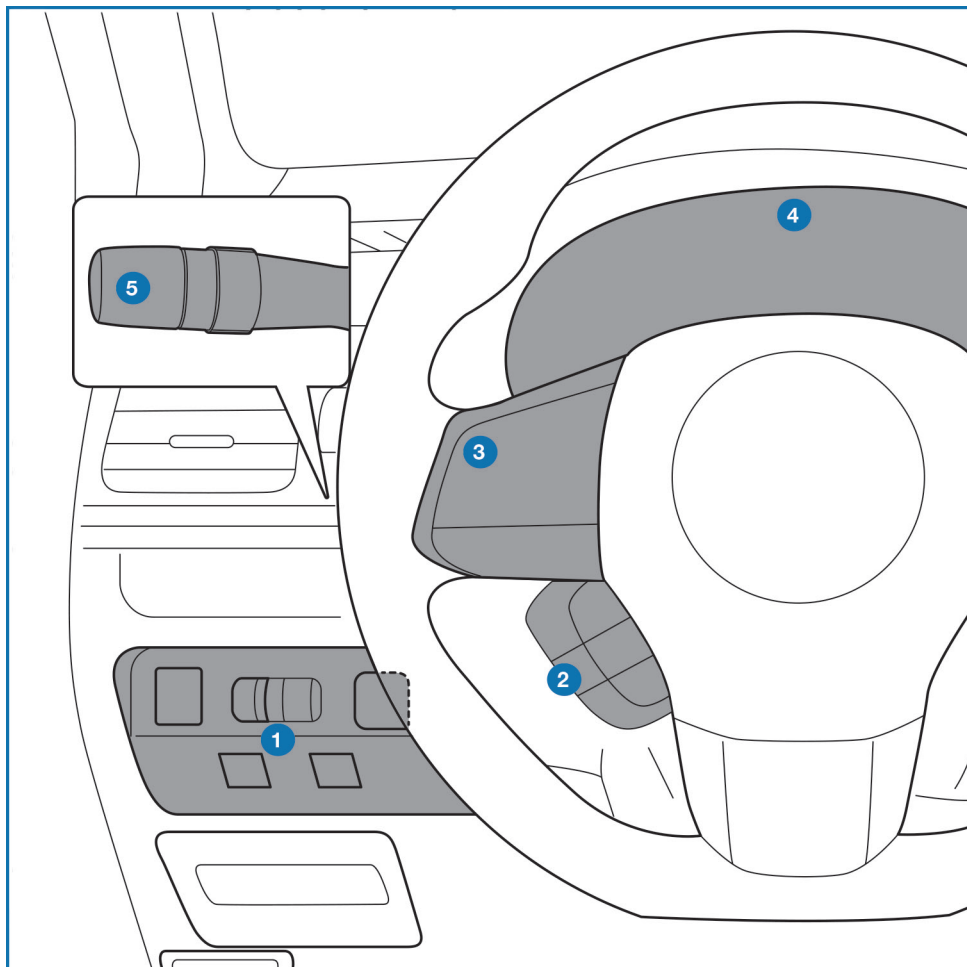

- ① Instrument Panel Switches (p. 24)
- ② I/Set Switch (p. 26)
- ③ Audio Controls (p. 24)
- ④ Combination Meter (p. 31)
- ⑤ Light Controls (p. 27)

INSTRUMENT PANEL

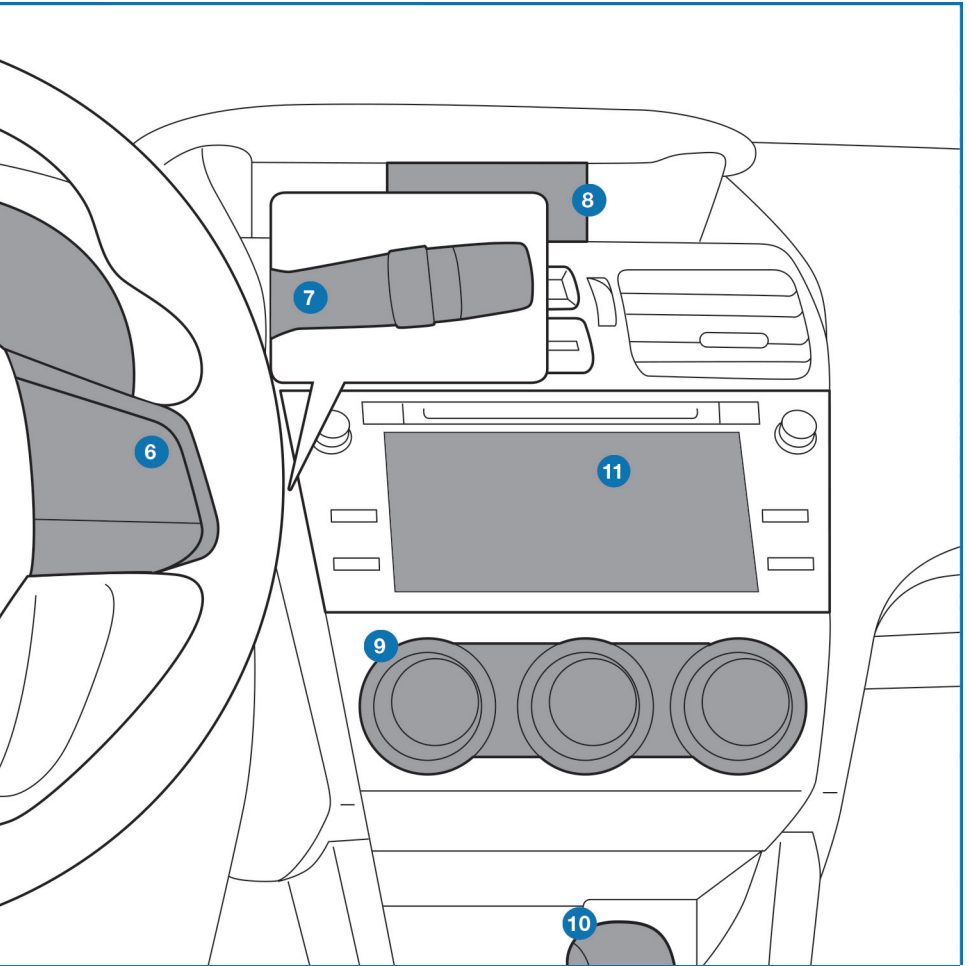

- ⑥ Cruise Control or Adaptive Cruise Control (p. 25)
- ⑦ Windshield Wipers (p. 28)
- ⑧ Multi-Function Display (MFD) (p. 26)
- ⑨ Climate control system (p. 18)
- ⑩ Shifter (MT) or CVT Select Lever (p. 33)
- ⑪ STARLINK® Multimedia Touchscreen (p. 49)

GETTING COMFORTABLE

SEATING

Manual Seats

- 1 Forward/Backward:** Pull the lever below the seat up and slide the seat forward or backward. Release the lever and make sure the seat is locked into place.
- 2 Seat Height (Driver's Seat):** Pulling up or pushing down on the lever will raise or lower the seat cushion.
- 3 Recline Seatback:** Pull the lever up to adjust the seatback. Release the lever and make sure the seatback is locked into place.



Manual Seat Levers

Power Driver's Seat (if equipped)

- 1 Seat Position:** Moving the switch forward or backward will adjust the seat in that direction. Pulling up or pushing down on the back of the switch will adjust the seat height up or down. Pulling up or pushing down on the front of the switch will adjust the angle of the seat cushion.
- 2 Recline Seatback:** Moving the top of the switch forward or backward will adjust the angle of the seatback.
- 3 Lumbar Support (if equipped):** Pressing the front of the switch will increase support. Pressing the rear of the switch will decrease support.



Power Seat Controls

GETTING COMFORTABLE

Head Restraint Adjustment

Pull the head restraint up to raise it. To lower the head restraint, push it down while pressing the release button on the top of the seatback. Each head restraint should be adjusted so that the center of the head restraint is closest to the top of the occupant's ears.

The angle of the front head restraints can be adjusted by tilting them forward. You will hear a click when the restraint locks in place. Pulling the head restraint as far forward as it will go allows it to return to the fully upright position.



Release Button and Head Restraint Adjustment

Seatbelt Adjuster

To keep yourself comfortable and safe, always position the seatbelt adjuster so the shoulder belt passes over the middle of your shoulder without touching your neck. Pull the tab out and slide the adjuster up or down to set the position. Release the tab and make sure the adjuster is locked in place.



Seatbelt Adjustment Tab

GETTING COMFORTABLE

TILT AND TELESCOPIC STEERING COLUMN

You can adjust both the height and lengthwise position of the steering wheel. Pull the lever on the side of the steering column down firmly to unlock, then adjust the position of the steering wheel. Push the lever firmly back up to lock the steering column in place.



Steering Column Unlock

POWER EXTERIOR MIRRORS

The power mirror knob works with the ignition in the "ON" or "ACC" position. Turn the knob to "L" (left side) or "R" (right side) to select a mirror. Push the knob in the direction you want to move the mirror. Turn the knob back to the center position when finished.



Power Mirror Knob

GETTING COMFORTABLE

REAR VIEW MIRROR

Auto-dimming Mirror (if equipped)

The auto-dimming function senses distracting glare during nighttime driving and automatically dims to eliminate the glare and preserve your vision. Press the switch to turn auto-dimming on or off. A green LED indicator on the switch illuminates when the function is on.



HomeLink® 5 Accessory Mirror (if equipped)

The HomeLink® 5 accessory mirror provides three buttons to replace devices such as garage door openers, gate openers, entry door locks, security systems, and home lighting. The Owner's Manual provides programming instructions, and www.subaru.com/homelink has a helpful "how to" video.



NOTE: HomeLink® 5 may not be compatible with some older door openers or additional equipment may be required.



Scan to learn more about HomeLink®.

GETTING COMFORTABLE

POWER WINDOWS

To open or close a window, partially press down or pull up and hold the corresponding switch. The front windows have a one-touch auto up/down function. Fully press down or pull up and release to automatically open or close a one-touch window.



Power Window Switches

GETTING COMFORTABLE

POWER MOONROOF (if equipped)

With the ignition in the "ON" position, you can tilt and slide the moonroof.

Tilting the Moonroof

- 1 Opening:** Press, briefly hold, and release the switch to automatically tilt the moonroof.
- 2 Closing:** Press and hold the switch to lower the moonroof.

Sliding the Moonroof

- 3 Opening:** Press, briefly hold, and release the switch to open the moonroof. It will stop slightly before the fully-open position to reduce wind noise. Press and release the switch again to fully open it.
- 4 Closing:** Press, briefly hold, and release the switch to close the moonroof. To pause the moonroof as it opens or closes, briefly press either side of the switch.

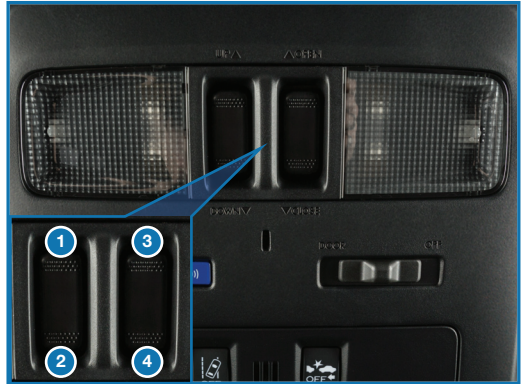

GETTING COMFORTABLE

CLIMATE CONTROL

Automatic Climate Control (WRX)

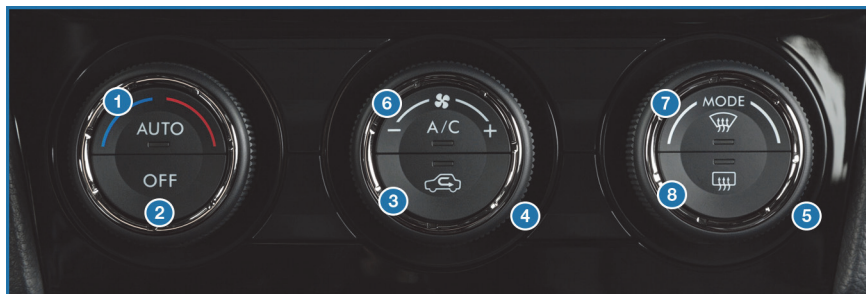

Set your desired temperature and let the system automatically make the adjustments for you. At any time, you can manually take control of the climate settings.

Operation in Automatic Mode

- 1 Automatic Control Button:** This system automatically controls all of the climate system except defogging. Press “AUTO” to activate. Press “OFF” to turn off the system.
- 2 Temperature Control Dial:** Turn the dial clockwise to increase the temperature or counterclockwise to decrease the temperature. The temperature will appear on the screen.

When using “Full Auto” mode, the fan speed, airflow distribution, air-inlet control and air conditioning compressor are controlled automatically. To activate “FULL AUTO” mode:

- Press the “AUTO” button. The indicator “FULL AUTO” illuminates on the Multi-Function Display (MFD).
- Set the preferred temperature using the temperature control dial.





If you operate any of the buttons other than “OFF”, the rear window defogger, or the temperature control dial, the “FULL” indicator will turn off. The “AUTO” indicator will remain. You can then manually control the system as desired. Press the “AUTO” button to change back to “FULL AUTO” mode.

Operation in Manual Mode

- 3 Recirculated/Outside Air Button:** Press this button to prevent outside air from entering your Subaru. Press the button again to allow outside air into your Subaru. NOTE: To prevent windshield fogging, do not remain in the recirculated mode for an extended period of time.
- 4 Fan Speed Control Dial:** Turn the fan speed control dial to increase or decrease fan speed.

GETTING COMFORTABLE

- 5 Airflow Mode Selection Dial:** Turn the dial to select the desired airflow mode. The selected air flow mode – ventilation, bi-level, feet or feet-defrost – is shown on the display.

ICON	MODE	FUNCTION
	Ventilation	Instrument panel outlets
	Bi-Level	Instrument panel outlets and foot outlets
	Feet	Foot outlets, both side outlets of the instrument panel and some through windshield defroster outlets
	Feet-Defrost	Windshield defroster outlets, foot outlets and both side outlets of the instrument panel
	Defrost	Windshield defroster outlets and both side outlets of the instrument panel

NOTE: The defroster button is used to activate the defrost airflow mode.

- 6 Air Conditioner Button:** Press this button to activate or deactivate the air conditioning.
- 7 Defroster Button:** Press this button to defrost or dehumidify the windshield and front door windows.
NOTE: The air conditioning compressor operates automatically to defrost the windshield more quickly. However, the indicator on the air conditioner button may not illuminate.
- 8 Rear Window Defogger Button:** Press this button to turn on the defogger. The outside mirror defogger and the windshield wiper deicer, if equipped, will also activate. It will automatically turn off after about 15 minutes. If the window clears before then, press the button again to turn it off. You can customize this function for continuous operation through the Multi-Function Display (MFD).

GETTING COMFORTABLE

Dual-zone Automatic Climate Control (WRX STI)



You can set separate temperatures for the driver and passenger seats. Set your desired temperature and let the system automatically make the adjustments for you. At any time, you can manually take control of the climate settings.

Operation in Automatic Mode

- 1 Automatic Control Button:** This system automatically controls all of the climate systems except defogging. Press “AUTO” to activate. Press “OFF” to turn off the system.
- 2 Temperature Control Dial:** Turn the dial clockwise to increase the temperature or counterclockwise to decrease the temperature. The temperature will appear on the screen. You can adjust separate temperature settings for the driver’s side and passenger’s side.

When using “Full Auto” mode, the fan speed, airflow distribution, air-inlet control and air conditioning compressor are controlled automatically. To activate “FULL AUTO” mode:

- Press the “AUTO” button. The indicator “FULL AUTO” illuminates on the Multi-Function Display (MFD).
- Set the preferred temperature using the temperature control dial.





If you operate any of the buttons other than “OFF”, rear window defogger, or the temperature control dial, the “FULL” indicator light will turn off. The “AUTO” light will remain illuminated. You can then manually control the system as desired. Press the “AUTO” button to change back to “FULL AUTO” mode.

Operation in Manual Mode

- 3 Recirculated/Outside Air Button:** Press this to prevent outside air from entering your Subaru. Press the button again to allow outside air into your Subaru.
NOTE: To prevent windshield fogging, do not remain in the recirculated mode for an extended period of time.
- 4 Fan Speed Control Dial:** Turn the fan speed control dial to increase or decrease fan speed.

GETTING COMFORTABLE

- 5 Airflow Mode Selection Button:** Press the button to select the desired airflow mode. The selected mode – ventilation, bi-level, feet or feet-defrost – is shown on the display.

ICON	MODE	FUNCTION
	Ventilation	Instrument panel outlets
	Bi-Level	Instrument panel outlets and foot outlets
	Feet	Foot outlets, both side outlets of the instrument panel and some through windshield defroster outlets
	Feet-Defrost	Windshield defroster outlets, foot outlets and both side outlets of the instrument panel
	Defrost	Windshield defroster outlets and both side outlets of the instrument panel

NOTE: The defroster button is used to activate the defrost airflow mode.

- 6 Dual Button:** Press the button to activate or deactivate the dual mode. Dual mode makes it possible to have separate temperature settings for the driver's side and passenger's side.
- 7 Air Conditioner Button:** Press this button to activate or deactivate the air conditioning.
- 8 Defroster Button:** Press this button to defrost or dehumidify the windshield and front door windows.
NOTE: The air conditioning compressor automatically operates to defrost the windshield more quickly. However, the indicator on the air conditioner button may not illuminate.
- 9 Rear Window Defogger Button:** Press this button to turn on the defogger. The outside mirror defogger and windshield wiper deicer will also activate. It will automatically turn off after about 15 minutes. If the window clears before, then press the button again to turn it off. You can customize this function for continuous operation through the Multi-Function Display (MFD).

GETTING COMFORTABLE

Heated Seats (if equipped)

The heated seat switches are located between the driver and passenger seats. There is a separate switch for the driver and passenger. Press the “HI” button for more rapid heating or press the “LO” button for normal heating. Return the switch to the center position to turn off the heated seat.



Heated Seat Switches

ACCESSORY CONNECTIONS

1 Power Outlets:

Power outlets (12V) are located below the climate control dials and in the center console storage compartment. Electrical power is available for use with in-vehicle electrical appliances with a maximum power rating of 120W. These outlets cannot be used to connect to the SUBARU STARLINK® multimedia system.

For more information, please refer to your Owner's Manual.

2 Auxiliary Input Jack:

The 3.5mm auxiliary input jack is located inside the center console storage compartment. You can connect a portable music player to the auxiliary jack and hear the music stored on it through your Subaru's speakers. Press the "Source" button located on the steering wheel or the "Media" button on the STARLINK® Touchscreen to select the auxiliary mode.

For more information, please refer to page 60 or your SUBARU STARLINK® Owner's Manual.

3 Dual USB Ports:

The USB ports are located in the center console storage compartment. You can connect a variety of USB-equipped device, such as portable music players or smartphones, to enjoy your favorite music through your Subaru's speakers. These ports also provide charging (5V, 2.1A) to devices.

For more information, please refer to page 60 or your SUBARU STARLINK® Owner's Manual.



Connection Ports

CONTROLS

INSTRUMENT PANEL SWITCHES (LOWER LEFT)

The switches in the lower left of the instrument panel allow you to control several convenient and important features. Knowing their location and function will improve your driving experience.

- 1 Blind Spot Detection/Rear Cross Traffic Alert OFF (if equipped, p. 88)
 - 2 Illumination Brightness (p. 27)
 - 3 Trunk lid release
 - 4 Vehicle Dynamics Control OFF
- For more information, please refer to your EyeSight® and vehicle Owner's Manuals.



AUDIO CONTROLS

- 1 Volume
 - 2 Presets/Skip
 - 3 Mute
 - 4 Source
 - 5 Voice Recognition
 - 6 Call/End
- For more information about your audio system and controls, please refer to page 52 or the SUBARU STARLINK® Owner's Manual.



CRUISE CONTROL

- 1 Resume (RES)/Increase Speed
 - 2 Set (SET)/Decrease Speed
 - 3 Cruise Control On/Off
 - 4 CANCEL
- ↑ For more information, please refer to your Owner's Manual.



ADAPTIVE CRUISE CONTROL (if equipped)

- 1 Resume (RES)/Increase Speed
 - 2 Set (SET)/Decrease Speed
 - 3 Lane Keep Assist
 - 4 Following Distance
 - 5 Adaptive Cruise Control On/Off
 - 6 SI-Drive (if equipped)
- ↑ For more information on SI-Drive, please refer to page 35 or your Owner's Manual.
- ↑ For more information on Adaptive Cruise Control, please refer to page 84 or the EyeSight® Owner's Manual.



CONTROLS

I/SET SWITCH

The “i/Set” switch allows you to cycle through useful driving information in the Combination Meter Display such as fuel consumption, driving time, and speed. You can change the information displayed using the up and down arrows.

When the Menu Entering Screen is displayed, pull and hold the “i/Set” switch to enter the Menu Screen for the ability to modify a number of vehicle settings.

 For more information, please refer to “Combination Meter Display” in your Subaru Owner’s Manual.

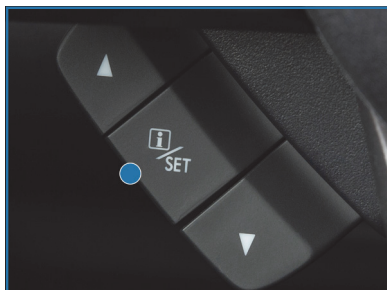

ENTER SWITCH

Push the switch up or down to cycle through useful information in the Multi-Function Display (MFD). Navigate to the guidance screen, then push and hold the “ENTER” switch to adjust a number of MFD settings.

 For more information, please refer to “Multi-Function Display” in your Subaru Owner’s Manual.



LIGHT CONTROLS

- 1 AUTO:** If equipped, rotate the end of the lever to set your headlights to automatically turn on or off, depending on the level of light outside.
NOTE: The sensitivity of the automatic headlights can be adjusted through the Multi-Function Display (MFD).
- 2 Parking Lights:** Rotate the end of the lever to turn on the instrument panel lights, parking lights, side marker lights, tail lights, and license plate lights.
- 3 Headlights:** Rotate the end of the lever to turn on the headlights, instrument panel lights, parking lights, side marker lights, tail lights, and license plate lights.
- 4 High Beams:** Push the lever forward to change from low beam to high beam. When set to the “AUTO” position, pushing the lever forward also activates the High Beam Assist (HBA) system, if equipped. Pull the lever back to center to return to low beam.
- 5 Fog Lights:** If equipped, rotate the dial to turn on the fog lights when the headlights are on.

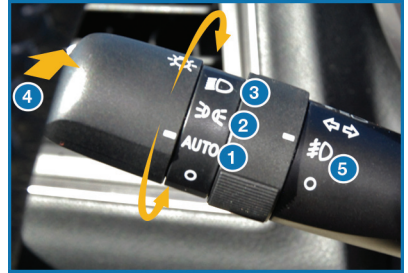

Illumination Brightness

When the light controls are on (in the D0E , D , or “AUTO” position), and ambient light is low, rotating the illumination brightness dial on the instrument panel upward will make the instrument panel illumination brighter. When the dial is fully rotated upward (dots aligned), the instrument panel illumination stays at full brightness. Rotating the dial downward dims the instrument panel illumination.



Illumination Brightness Dial

When the ambient light is bright, the illumination brightness is set to the maximum regardless of the position of the control dial.

CONTROLS

Daytime Running Lights

The daytime running lights automatically turn on when the engine is running, the parking brake is released, the select lever is out of the “P” position, and the light switch is set to Off, “AUTO” (if equipped), or “ DRL ”. Always turn on the headlights when it’s dark outside by rotating the dial to the “ D ” or “AUTO” position.

TURN SIGNALS

Push fully up for the right turn signal and fully down for left turn signal. Your Subaru also has a one-touch lane changer feature: push slightly up and release to signal a right lane change or push slightly down and release to signal a left lane change.



WINDSHIELD WIPERS

To turn on the wipers, press the wiper control lever down one position for intermittent, two positions for low speed, or three positions for high speed. When the lever is in the intermittent position, rotate the dial to adjust the operating interval of the wipers. To turn the wipers off, return the lever to the “OFF” position. For a single wipe, move the lever up from the “OFF” position.

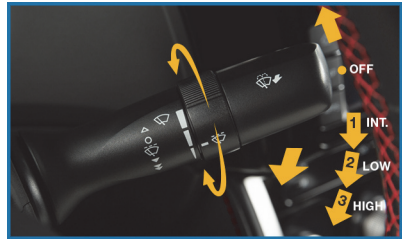

Pull the lever toward you to wash the windshield. The washer will spray and the wipers will operate while you pull the lever.

OVERHEAD PANEL

1 SOS Emergency

Assistance: Press the “SOS” button to connect with a SUBARU STARLINK® Customer Care Advisor (Subscription required). Press and hold the button for about two seconds to cancel the call.

For more information, please refer to page 70 or the SUBARU STARLINK® Safety and Security Owner’s Manual.

2 Enhanced Roadside

Assistance: Press the “i” button to connect with a SUBARU STARLINK® Roadside Assistance Provider (Subscription required). Press and hold the button for about two seconds to cancel the call.

For more information, please refer to page 70 or the SUBARU STARLINK® Safety and Security Owner’s Manual.

3 Automatic Illumination: When the switch is in the “DOOR” position, the map lights illuminate when any door is opened, the doors are unlocked using the remote keyless entry system or keyless access function, or the ignition is turned from “ON” or “ACC” to “LOCK”/“OFF”.

4 Map Lights: For WRX, press a map light to turn it on or off.

5 Lane Departure Warning OFF switch: Press and hold this switch for two seconds to turn off the Lane Departure Warning and the Lane Sway Warning functions. Press and hold the switch again for two seconds to turn the systems back on.

For more information, please refer to page 86 or the EyeSight® Owner’s Manual.



WRX



WRX STI

CONTROLS

- 6 Pre-Collision Braking System OFF switch:** Press and hold this switch for two seconds to turn off the Pre-Collision Braking System and Pre-Collision Throttle Management. Press and hold the switch again for two seconds to turn the systems back on.
- For more information, please refer to page 86 or the EyeSight® Owner's Manual.
- 7 Power Moonroof:** Use these switches to operate the power moonroof.
- For more information, please refer to page 17 or your Owner's Manual.
- 8 Map Light Button:** For STI, press the button to turn the light on or off.
- NOTE: These lights can remain on even when the ignition is off, key removed from vehicle, and doors are locked.

GAUGES AND WARNING LIGHTS

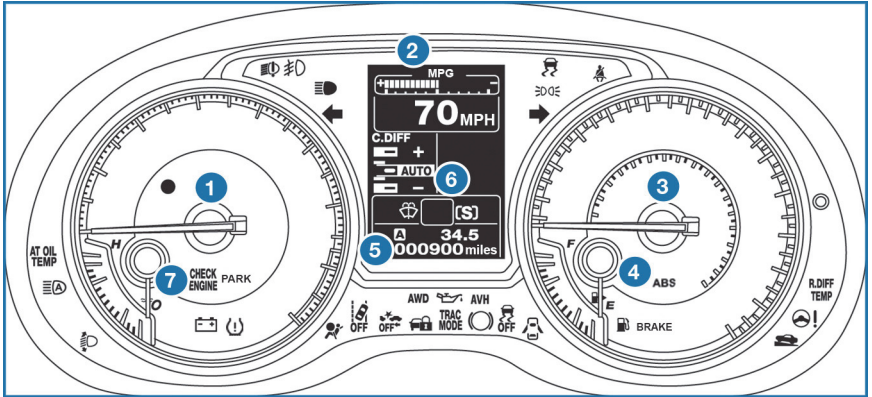

COMBINATION METER





- 1 Tachometer
- 2 Combination Meter Display (CMD)
- 3 Speedometer
- 4 Fuel gauge
- 5 Trip meter and odometer
- 6 Select lever/gear position indicator
- 7 Engine coolant temperature gauge

WARNING AND INDICATOR LIGHTS

Red lights indicate immediate attention is required. Some examples are:

	Seatbelt warning		Door open	BRAKE / 	Brake system
---	------------------	---	-----------	--	--------------

Yellow lights indicate caution. Some examples are:

	Low fuel		Engine oil level warning light		Tire pressure warning light
---	----------	---	--------------------------------	---	-----------------------------

Green and blue lights are for information. Some examples are:

	Headlight indicator light	AVH	Auto Vehicle Hold ON		High beam indicator light
---	---------------------------	------------	----------------------	---	---------------------------

OPERATING THE VEHICLE

IGNITION SWITCH

The ignition switch has four positions:

LOCK: You can only insert or remove the key in this position.

ACC (Accessory): Provides power to the radio and accessory power outlets.

ON: All electrical systems are available. The key returns to this position after starting the engine.

START: Turn the key to this position to start the engine.

PUSH-BUTTON IGNITION SWITCH (if equipped)

Each time you press the ignition switch without depressing the brake pedal, the ignition position will change as follows: ACC, ON, OFF.

ACC (Accessory): Provides power to the radio and accessory power outlets. Orange indicator illuminates.

ON: All electrical systems are available. Orange indicator illuminates.

OFF: Power off and indicator off.



STARTING THE VEHICLE

Without Push-button Ignition

To start the engine:

1. Make sure the select lever is in the "P" position (or neutral position and depress the clutch for manual transmission vehicles).
2. Using the key, turn the ignition switch to "START".

NOTE: Do not depress the accelerator pedal. Release the key as soon as the engine starts.

With Push-button Ignition

To start the engine:

1. Sit in the driver's seat with the access key fob.
2. Make sure the select lever is in the "P" position or neutral for manual transmission vehicles.
3. Depress the brake pedal (and clutch pedal for manual transmission vehicles).
4. When the Engine START/STOP button indicator turns green, briefly press and release the Engine START/STOP button.

DRIVING THE VEHICLE

6-Speed Manual Transmission

This manual transmission is a fully synchronised 6-forward and 1-reverse speed transmission. To shift into the “R” position, raise and hold the slider ring, move the lever into the “R” position, then release the slider ring. Only pull the slider ring up when shifting into reverse gear.



Automatic Transmission Shift Mode (if equipped)

The Continuously Variable Transmission (CVT) is electronically controlled and provides two different driving modes: normal and manual.

Normal Mode

When the select lever is in the “D” (Drive) position, the transmission is in normal shift mode. The select lever position indicator in the Combination Meter Display (CMD) shows “D” and the transmission automatically shifts into a suitable forward gear.

Manual Mode

In manual mode, you select the desired gear position to obtain necessary acceleration and engine braking. Move the select lever left from the “D” position into the “M” position to select manual mode. The gear position indicator in the Combination Meter Display (CMD) shows the currently selected gear. Arrow-shaped indicators show when upshifting or downshifting is available. To shift, use the paddle shift control switches behind the steering wheel.



OPERATING THE VEHICLE

Paddle Shift Control Switches

You can shift gears using the paddle shift control switches. To upshift to the next higher gear, pull the “+” paddle on the right toward you. To downshift to the next lower gear, pull the “-” paddle on the left toward you.

You can temporarily shift gears even when the select lever is in the “D” position by pulling either the “+” or “-” paddle toward you. Once vehicle speed stabilizes, the transmission will switch back to normal mode.



REV Alarm System (WRX STI only)

The REV alarm system automatically issues a warning using the REV indicator light whenever the tachometer needle enters the red zone. This feature can be turned on or off using the Combination Meter Display (CMD). The REV alarm level can be set for an engine speed of your choosing between 2,000 and 6,700 rpm. The Combination Meter Display (CMD) is also used to select a warning alarm buzzer in addition to the light.



 Please refer to your Owner's Manual for more detailed instructions on setting the engine speed alarm level and selecting the warning buzzer.

OPERATING THE VEHICLE

SI-Drive (if equipped)

SI-Drive has 3 modes; Intelligent (I), Sport (S) and Sport Sharp (S#). Each mode is designed for different types of driving:

- **Intelligent:** The Intelligent (I) mode provides well balanced performance with greater fuel efficiency and smooth driveability without stress. Power delivery is moderate during acceleration for maximum fuel efficiency.
- **Sport:** The Sport (S) mode provides the engine power desired by those who want to make the driving experience their own personal adventure.
- **Sport Sharp:** The Sport Sharp (S#) mode offers an exhilarating level of engine performance and control. The throttle becomes more responsive regardless of the engine speed. Delivering maximum driving enjoyment, this mode is ideal for driving on twisting roads and for merging or overtaking other vehicles on the freeway with confidence.

WRX STI

To select Sport (S) mode, turn the selector toward “S”. For Sport Sharp (S#) mode turn toward “S#”. Press down on the selector button for Intelligent mode.



WRX

The control switches for the WRX are on the steering wheel on the right side.

To select Sport (S) mode when in a different mode press the “S/I” button. To select Sport Sharp (S#) mode when in a different mode select the “S#/I” button. To select Intelligent (I) mode when in Sport (S) mode press the “S/I” button, when in Sport Sharp (S#) mode press the “S#/I” button.



OPERATING THE VEHICLE

Driver Control Center Differential (DCCD) (WRX STI only)

This electronically controlled system adjusts the power-distribution ratio between the front and rear wheels. The system is designed to provide optimum differential control for improved vehicle cornering, stability, and handling control to suit driving and road surface conditions. The DCCD can be operated automatically or manually.



When the system is in the automatic mode, the “AUTO” indicator light in the combination meter illuminates. The DCCD can be taken out of “AUTO” mode and used manually by pressing the “AUTO MANU” switch located on the center console. Pressing the “AUTO MANU” switch again will return the system to “AUTO” mode.

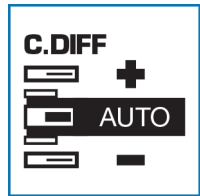

When in “AUTO” mode you can use the “C.DIFF” switch to change between AUTO [+], AUTO, and, AUTO [-]. To change to AUTO [+] push the C.DIFF switch forward. To change to AUTO [-] push the C.DIFF switch rearward.

- **AUTO [+]:** This mode emphasizes traction control and strengthens the limitation of differential action that is suitable for driving on slippery roads for vehicle stability.
- **AUTO:** This mode is suitable for most driving situations.
- **AUTO [-]:** This mode is suitable when you seek quick response from the steering wheel and smooth driving.

To use manual mode press the “AUTO MANU” switch then push the “C.DIFF” switch forward to increase the Limited Slip Differential (LSD) torque or rearward to reduce the LSD torque

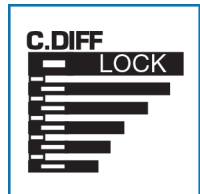

When using the system manually, if the control switch is set closer to or at the “Lock” position, the powertrain may make a vibration or noise when the vehicle is in tight turns at slow speeds (system binding). In addition, if the rear differential oil exceeds a certain temperature, the DCCD will automatically cancel the current torque-distribution ratio setting and adopt its minimum ratio.

ELECTRONIC PARKING BRAKE (EPB) (if equipped)

To apply the parking brake, depress the brake pedal and pull the parking brake switch up. The indicator light on the parking brake switch will illuminate and "PARK" will appear in the Combination Meter.

To release the parking brake manually, depress the brake pedal and push the parking brake switch down. To automatically release the parking brake, gently press the accelerator pedal with the select lever in the "D" or "R" position.



NOTE: Automatic parking brake release will not work unless all the doors are closed and your seatbelt is fastened.

OPERATING THE VEHICLE

Auto Vehicle Hold (AVH) (CVT models — if equipped)

Auto Vehicle Hold gives your feet a break by automatically holding your Subaru in place when at a complete stop, such as a traffic signal, even after you release the brake pedal. Press the Auto Vehicle Hold switch on the center console to turn on the function. The AVH indicator in the combination meter will illuminate.

While your Subaru is being held by this function, the operation indicator in the combination meter will illuminate. The function is canceled when you depress the accelerator pedal or the brake pedal.

Press the switch again to turn it off. The function works with the select lever in either the “D” or “R” position.

NOTE:

- For this system to work your seatbelt must be fastened.
- Make sure to turn off this function before entering an automatic car wash.



ICON	MODE
AVH	Auto Vehicle Hold ON
	Auto Vehicle Hold IN OPERATION

TURNING OFF THE VEHICLE

Without Push-button Ignition

To stop the engine:

1. Stop your Subaru completely.
2. Move the select lever to the “P” position or set the parking brake for manual transmission vehicles.
3. Turn the ignition switch to “OFF”.

NOTE: The front windows will remain active for about 40 seconds and the SUBARU STARLINK® Multimedia System will remain on for about three minutes or until a door is opened, whichever occurs first.

With Push-button Ignition

To stop the engine:

1. Stop your Subaru completely.
2. Move the select lever to the “P” position or set the parking brake for manual transmission vehicles.
3. Press the ignition switch.

NOTE: The front windows will remain active for about 40 seconds and the SUBARU STARLINK® Multimedia System will remain on for about three minutes or until a door is opened, whichever occurs first.

REFUELING

FUEL FILLER LID

To open the fuel filler lid, pull up the fuel filler lid release lever located on the floor to the left of the driver's seat.

The fuel filler lid is located toward the rear of the passenger side.

While refueling, place the fuel filler cap on the cap holder inside the lid.

After refueling, put the cap back on and turn it clockwise until you hear a clicking noise. Be certain not to catch the tether under the cap while tightening.

To close the lid, press it until you hear it latch.

NOTE: If the fuel filler cap is not tightened until it clicks or if the tether is caught under the cap, the Check Engine warning light may illuminate.



Fuel Filler Lid Release



Fuel Filler Lid and Cap

FUEL

WRX: use premium unleaded gasoline with an octane rating of 91 AKI or higher. If 91 AKI fuel is not readily available, regular unleaded gasoline with an octane rating of 87 AKI or higher may be temporarily used. However, depending on your driving habits and conditions, you may notice a decrease in engine performance, fuel economy and slight engine vibration or knocking. Do not use fuels with more than 10% ethanol.

WRX STI: use premium unleaded gasoline with an octane rating of 93 AKI or higher. If 93 AKI fuel is not readily available in your area, premium unleaded gasoline with an octane rating of 91 AKI may be used with no detriment to engine durability or driveability. However, you may notice a slight decrease in maximum engine performance while using 91 AKI fuel. Do not use fuels with more than 10% ethanol.

 For more information, please refer to the Owner's Manual.

FUEL CAPACITY

	Capacity
Full Fuel Tank	15.9 US gallons
Low Fuel Warning Light	2.6 US gallons

PASSENGER/CARGO AREAS

FOLDING THE REAR SEATS

First, lower the headrests. Then, pull up on the release knob until you can see the red at the bottom of the knob and fold down the seats.

To return the seatback to its original position, raise the seatback until it locks into place. You will no longer be able to see the red at the bottom of the knob when the seat is locked.



Seat Release Knob

CHILD SAFETY LOCKS

The child safety locks are located on the inside edges of the rear doors. In the locked position, the rear doors can only be opened from the outside.



PASSENGER/CARGO AREAS

LATCH/ANCHOR

Your Subaru is equipped with Lower Anchors and Tethers for Children (LATCH). For maximum safety, first carefully read the LATCH system instructions from the device manufacturer, as well as the installation instructions in your Owner's Manual, to properly install the LATCH compatible restraint system. Use the appropriate seatbelts or anchorages provided in your Subaru. Children age 12 and under must properly occupy the rear seat at all times.

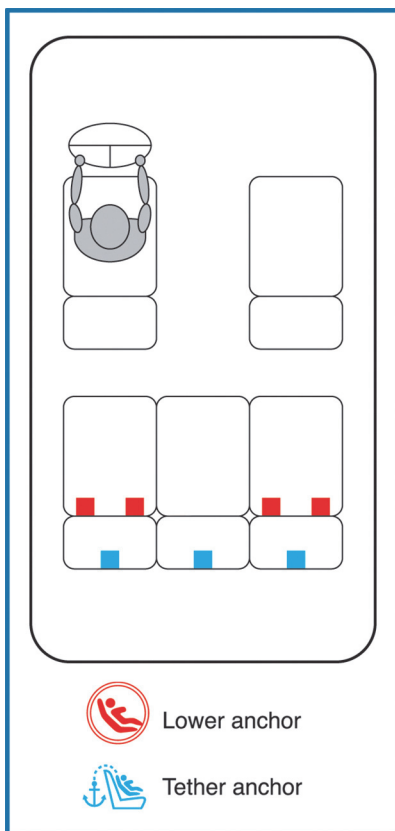

INTERNAL SAFETY TRUNK RELEASE WITH SELF-ILLUMINATING HANDLE

In the event that children or adults become locked inside the trunk, this luminescent handle allows them to open the lid from inside the trunk. To open, simply pull the yellow handle as indicated by the arrow on the handle and then push up on the lid.



SPARE TIRE AND JACK

A jack and other maintenance tools are stored in the tool bucket in the center of the spare tire, located under the cargo floor.

Your vehicle is equipped with the following maintenance tools.

- Jack
- Jack handle
- Screwdriver
- Towing hook (eye bolt)
- Wheel nut wrench



 For more information, please refer to “Maintenance Tools” in your Owner’s Manual.

ENGINE COMPARTMENT

2.0 L ENGINE (WRX)



- | | | | |
|---|------------------------|---|--------------------------|
| 1 | Brake Fluid Reservoir | 6 | Engine Coolant Reservoir |
| 2 | Main Fuse Box | 7 | Radiator Cap |
| 3 | Battery | 8 | Engine Oil Dipstick |
| 4 | Windshield Washer Tank | 9 | Air Cleaner Element |
| 5 | Engine Oil Filler Cap | | |

 Please refer to the Warranty and Maintenance Booklet for recommended replacement intervals.

ENGINE COMPARTMENT

2.5 L ENGINE (WRX STI)



- | | |
|--|-----------------------------------|
| 1 Brake Fluid Reservoir/Clutch Fluid Reservoir | 6 Engine Coolant Reservoir |
| 2 Main Fuse Box | 7 Coolant Filler Tank Cap |
| 3 Battery | 8 Engine Oil Dipstick |
| 4 Windshield Washer Tank | 9 Air Cleaner Element |
| 5 Engine Oil Filler Cap | 10 Power Steering Fluid Reservoir |

 Please refer to the Warranty and Maintenance Booklet for recommended replacement intervals.

ADDITIONAL SPECIFICATIONS

NEW VEHICLE BREAK-IN

The performance and long life of your Subaru are dependent on how you handle and care for your Subaru while it is new.

Follow these instructions during the first 1,000 miles:

- Do not race the engine.
- Do not drive at one consistent engine or vehicle speed, either fast or slow.
- Avoid starting suddenly and rapid acceleration, except in an emergency.
- Avoid hard braking, except in an emergency.

ENGINE OIL

Use 5W-30 synthetic, with one of the following specifications:

- API classification SN or SN PLUS with the words "RESOURCE CONSERVING".
- ILSAC GF-5, which can be identified with the ILSAC certification mark (Starburst mark).

ENGINE OIL CAPACITY

Engine	Capacity (during oil and filter change)
WRX 2.0L	5.4 US quarts
WRX STI 2.5L	4.5 US quarts

When the level is at the "low" mark, add approximately 1 quart of engine oil in through the filler cap to bring the oil level to the "full" mark. For filler cap location see the engine compartment on page 44 or page 45.

- 1 Full Level
- 2 Low Level

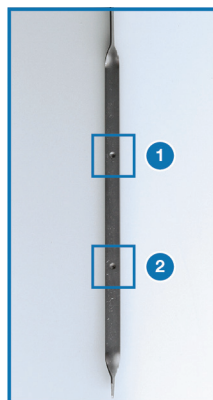

ADDITIONAL SPECIFICATIONS

ROOF RAIL CAPACITY (if equipped)

Cargo can be carried after securing a roof crossbar kit to the roof molding and installing the appropriate carrying attachment. When installing the roof crossbar kit, follow the manufacturer's instructions and make sure that the total weight of the crossbars, carrying attachment, and cargo does not exceed the maximum load limit. The maximum total load on the roof (including crossbars, carrying attachments and cargo) must not exceed 88 pounds.

 For more information, please refer to your Owner's Manual.

TRAILER TOWING CAPACITY

Your Subaru is neither designed nor intended to be used for trailer towing. Therefore, never tow a trailer with your vehicle.

 For more information, please refer to your Owner's Manual.

ADDITIONAL SPECIFICATIONS

TIRE PRESSURE MONITORING SYSTEM (TPMS)

Your Subaru has a Tire Pressure Monitoring System (TPMS).

A low tire pressure warning light illuminates in the Combination Meter when one or more of your tires is significantly under-inflated. When the warning light illuminates, stop and check your tires as soon as possible, and inflate them to the proper pressure.



Tire pressure specification is listed on the tire specification placard located on the driver's side door pillar.



Tire Specification Placard

OVERVIEW OF YOUR MULTIMEDIA SYSTEM

SUBARU STARLINK® Multimedia combines the radio along with the ability to connect your phone* through Bluetooth® to the multimedia system for making calls, sending text messages and listening to your favorite songs on your phone.

* Compatible smartphone and application required. For applications to operate, latest version of each application required. Data provided by smartphone is displayed on the Touchscreen. Some state laws prohibit the operation of handheld electronic devices while operating a vehicle. Smartphone apps should only be launched when vehicle is safely parked. Your wireless carrier's rates may apply.

Various Systems

Depending on your model and trim level there are several types of SUBARU STARLINK® Multimedia systems. Some of the functions described in this guide will vary by system.

- 6.5-inch Multimedia Plus
- 7.0-inch Multimedia Plus
- 7.0-inch Multimedia Navigation

BUTTONS

Radio Functions

1 Power/Volume Control

Press the power/volume control knob to mute or un-mute the audio. Rotate the knob left to decrease or right to increase the volume.

2 Tune

Rotate the knob to change the radio station or select the next track/media file. Press and hold the knob to display the sound settings screen.

3 Radio

Press the RADIO button to display the AM/FM/SXM screen. The different tuner modes can be selected by touching the source you want to hear.

4 Seek

Press the seek up or seek down button to seek the next or previous radio frequency. You can also use the seek up or down buttons to select different audio tracks from media sources. Press and hold to fast-forward or rewind.



STARLINK OVERVIEW

CD Player Functions

5 Load

Insert the disc into the loading slot. The CD will automatically be drawn in and begin playing the first track.

6 Eject

Press the Eject button on the left side of the loading slot to remove the CD from the player.

Other Functions

7 Home

Displays the Home screen apps. The Home screen allows you to customize which apps appear and rearrange the icons in a personalized order.

8 Map (if equipped)

Displays the map and navigation features available on the screen.

9 Apps

Displays the installed apps that are available on your vehicle.

Controlling the Volume

Adjusting the Volume: Turn the VOLUME knob to adjust the volume. The volume stays at the level you set after an ignition cycle.







Muting the Volume: You can mute the audio system by pressing the volume knob once, and un-mute the audio by pressing the knob again. It will un-mute automatically after an ignition cycle.

Turning the System Off: To turn the audio system off, press and hold the volume knob for about three seconds. The system remains off after an ignition cycle. Press the volume knob again to turn the audio system back on.

STARLINK OVERVIEW

TOUCHSCREEN

Operations are performed by touching the screen directly with your finger.

MOTION	ACTION	USE
	Touch Quickly touch and release once.	Changing and selecting various settings
	Double Touch with one finger* Quickly touch and release twice with one finger.	Enlarging the scale of the map screen
	Double Touch with two fingers* Quickly touch and release twice with two fingers.	Reducing the scale of the map screen
	Drag** Touch and drag your finger on the screen to move the screen to the desired position.	<ul style="list-style-type: none">• Scrolling the lists• Scrolling the map screen*
	Swipe** Quickly move the screen by swiping with your finger.	<ul style="list-style-type: none">• Scrolling the lists• Scrolling the map screen*
	Pinch* Move your two fingers further apart (pinch-out) to zoom in on the map. Move your two fingers closer together (pinch-in) to zoom out on the map.	Changing the scale of the map screen

* 7-inch with Navi system only

** The operations may not be performed on all screens.

STARLINK OVERVIEW

STEERING WHEEL CONTROLS

- 1 Volume:** Press the plus side to increase volume and the minus side to decrease volume.
- 2 Presets/Skip:** Press to toggle through your preset radio stations or change a track/media file. Press and hold to scan radio stations or fast-forward/rewind media files.
- 3 Mute:** Press to mute audio.
- 4 Source:** Press the source button to change the audio sources between radio modes and media modes.
- 5 Voice Recognition:** Press to initiate the built-in voice recognition system. Press and hold to cancel voice recognition. If connected to an iPhone, press and hold the voice recognition button to initiate Siri.
- 6 Call/End:** Press to receive or end a call without taking your hands off of the steering wheel.



Starlink Audio Controls

VOICE RECOGNITION

With SUBARU STARLINK[®], simple voice commands can control features like navigation, entertainment, phone calls, and, on select models, climate control. A microphone is located in the overhead console; however, you do not need to speak directly into it to activate the voice command features.

 Visit

www.subaru.com/engineering/starlink/multimedia.html for more information.

Press the Voice Recognition button on the steering wheel to start the voice recognition system. Press and hold the button to cancel the system.

For help with what features are available with voice recognition, press the "Help" button on the screen or press the voice recognition button and say "Help".

Tips

The system may not recognize the voice command due to various types of interference. Some causes for voice command interference are:

- The command is spoken too quickly or at a low or high volume.
- The command is incorrect or unclear.
- The window is open, the climate control system is set on high, or the ventilation is directed toward the microphone.
- Passengers are talking while the command is spoken.

In some cases, you may not be able to use voice commands if the system cannot properly recognize the command. For example, the command is incorrect or unclear.

NOTE: The system is designed to recognize a variety of commands, but certain words, accents or speech patterns may be difficult for the system to recognize.

Google Assistant: May not work with all devices or may not be compatible with the audio system.

Siri Eyes Free: Press and hold the Voice Recognition Button when your phone is connected via bluetooth for Siri Eyes Free.



Scan to learn more
about **Subaru
Multimedia.**

STARLINK OVERVIEW

Common Commands

Below are examples of common commands that can be used with the voice recognition system. Please refer to your SUBARU STARLINK[®] Owner's Manual for a complete list.

VOICE COMMAND	FUNCTION	EXAMPLE
Dial [Number]	Places a call to the phone number	Dial 555-123-4567
Call [Name] [Phone Type]	Places a call to the contact name and phone type of the contact from the phonebook	Call John Doe mobile
Navigate to [House Number, Street, City, State] ¹	Sets a destination to the address	Navigate to 1234 Main Street, Lincoln, Washington
Show Map ¹	Displays the map screen	Show Map
Where am I ¹	Displays current location on map	Where am I
Tune to [Frequency] (AM / FM)	Switches to AM/FM and tunes to spoken frequency	Tune to 99.5 FM
Preset [Number]	Switches to the preset channel	Preset 3
Satellite Channel [Name / Channel Number]	Switches to satellite channel number	Satellite Channel Prime Country 55
Set Fan Speed to [1-7] ²	Sets the fan speed to the spoken fan speed	Set fan speed to 4
Set Temperature to [Number] ^{2,3}	Sets the temperature to the spoken temperature	Set temperature to 70
Help	Changes to help screen	Help
Phone Help	Displays a list of voice commands related to controlling your phone	Phone Help
Media Help	Displays a list of commands related to the media	Media Help
Radio Help	Displays a list of commands related to the radio	Radio Help
Navigation Help ¹	Displays a list of voice commands related to navigation	Navigation Help

1 7.0-inch Multimedia Navigation system only

2 7.0-inch Multimedia Plus and 7.0-inch Multimedia Navigation system only

3 When the A/C is off, the A/C setting will not change even if the voice command is accepted

HOME SCREEN ICONS

Phone – Allows you to place and receive calls and text messages.

Map – Allows you to enter a destination and have route guidance to get you where you are going.

Settings – Allows you to change the settings to your personal choice for select systems inside the vehicle.

Add Shortcut – Allows you to add icons for various functions to the home screen.

Apps – Entertainment and convenience applications that can be used to enhance your driving experience. The apps included are: MySubaru, Pandora®, Travel Link®, Android Auto™, SUBARU STARLINK®, aha™, and Apple Car Play®.

Media – Allows you to play CDs, USB/iPod music, or Bluetooth® audio by connecting to the device.

Radio – Allows you to select a station to listen to as well as pause and playback live radio.

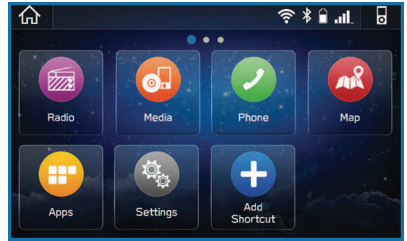

Home Screen Icons



Scan to learn more
about
SUBARU STARLINK®.

REARRANGING ICONS

You can rearrange the icons on the Home Screen when the Home Screen Shortcuts function is turned on. You can turn on the Home Screen Shortcuts function by selecting “Settings”, then the “General” tab.

To rearrange icons on the Home Screen:

1. Select and hold the icon you want to move.
2. Drag the icon to the desired position and release.
3. To delete an icon, drag the icon to the bottom of the screen and release.

STARLINK HOME

ADDING SHORTCUTS

You can add shortcut icons for various functions to the Home Screen when the Home Screen Shortcut function is turned on. You can turn on the Home Screen Shortcuts function by selecting "Settings", then the "General" tab.

To add shortcut icons to the Home Screen, press the "Home" button.

1. Select "Add Shortcut".

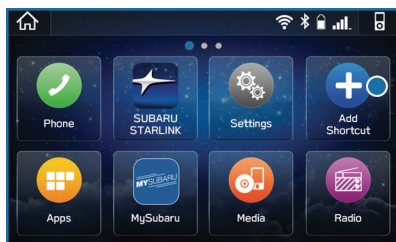

2. Select the desired function.

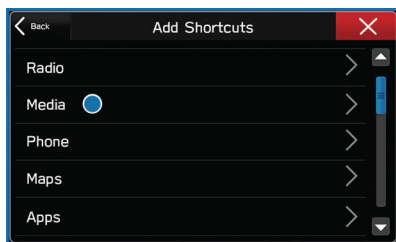

3. Select the desired shortcut function.
4. Check that the shortcut icon is displayed on the Home screen.

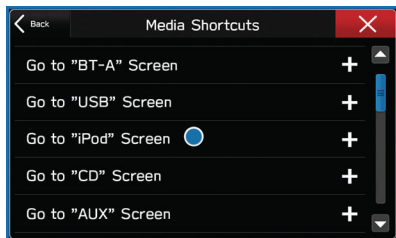

CREATING A DRIVER PROFILE

Creating a Driver Profile provides many benefits beyond just pairing a phone. The profile records and remembers station presets, sound preferences, home and work address (if equipped with navigation), phone favorites, screen icons and placement, and the background wallpaper.

To create a driver profile:

1. On the Home screen, select “Settings”.
Then, in the General menu, select “Driver Profile”.

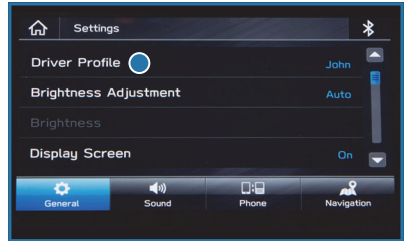

2. Select “Add New Profile”.

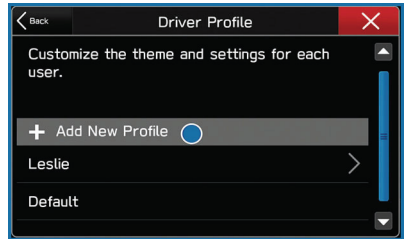

3. Select “Enter Name” to display the keyboard screen then type your name.
Now select “Next” on this screen and the following screen.

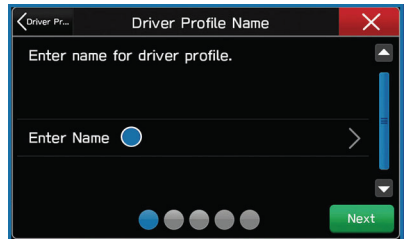

DRIVER PROFILE

4. Select a paired phone or pair a new phone (see page 93 and page 97 in the How To Appendix). Then select “Next”.

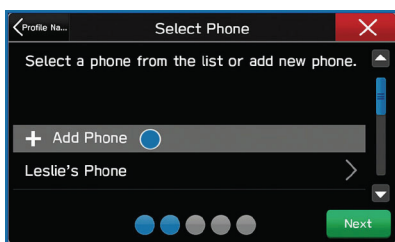

5. Enter a Home Address and Work Address (if equipped with navigation). Then select “Next”.

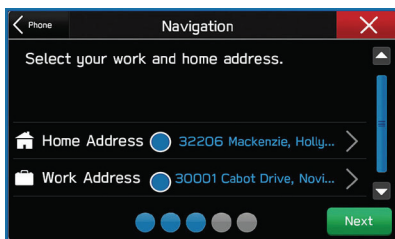

6. Select a Wallpaper then select “Next”.
7. Select “Finish”.

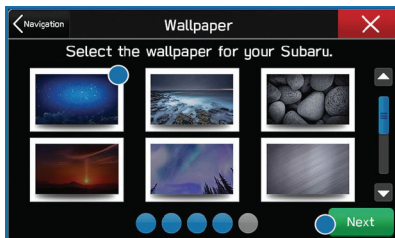

Retrieving a Driver Profile

The system automatically retrieves the profile once you are in your Subaru with the STARLINK® multimedia system on and your phone's Bluetooth® active. You can also manually retrieve or change the profile by following these steps:

1. Press the “Home” button and then select “Settings”.
2. In the General menu, select “Driver Profile”.
3. Select the profile you want to use, and then select “Activate”.

RADIO

AM/FM Radio

Your Subaru is equipped standard with AM/FM radio, including HD Radio®. HD Radio® technology allows you to receive digital broadcasts (where available) in addition to analog broadcasts. Digital broadcasts provide free, crystal clear audio with no static or distortion.

➤ Visit www.hdradio.com for more information and a guide to available radio stations and programming.



Scan to learn more about HD Radio.

Satellite Radio

A SiriusXM® Satellite Radio is a tuner designed exclusively to receive broadcasts provided under a separate subscription. After a free trial period, a subscription is necessary to continue service.

➤ For more information or to subscribe, visit www.siriusxm.com.

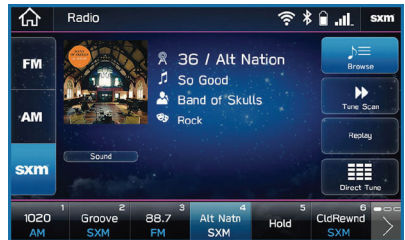

Scan to learn more about SiriusXM Radio.

MULTIMEDIA

Presets

You can preset 18 stations. Presets can be set for SiriusXM®, FM, or AM stations, allowing you to switch among the three with the press of a single button. To preset a radio station:

1. Tune to the desired channel.
2. Press and hold the desired preset station button at the bottom of the screen.

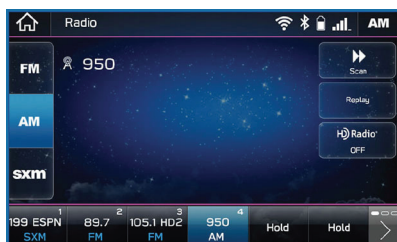

MEDIA

Bluetooth®

Your Subaru has Bluetooth® hands-free technology to manage your phone and audio systems. Bluetooth®-enabled mobile phones link directly through your Touchscreen automatically once connected. Bluetooth® Hands-free allows you to receive and initiate calls, or play music directly from your device while keeping it stowed for safety.

For step-by-step instructions on how to pair a Bluetooth® device to the Touchscreen, please see page 93 for Android devices or page 97 for Apple devices. A QR code and link to more information on pairing a Bluetooth® device can also be found on page 61.

CD

The CD player holds a single disc. To access the CD menu, put a CD in the player or select the CD icon on the “Media” Screen. Depending on the CD format, the CD album art work may appear on the Touchscreen.

USB / iPod

You can plug in a USB memory storage device or iPod into the USB ports. This will bring up the media screen with controls. If using an iPod, make sure to use an Apple certified cable or MFi certified cable for proper operation.

Aux Input

The Aux jack is a port that allows input from an audio device such as MP3 players, portable music players, and iPods. To access the Aux menu, plug in the device to the Aux jack and the menu will appear, or select the Aux menu from the “Media” Screen.

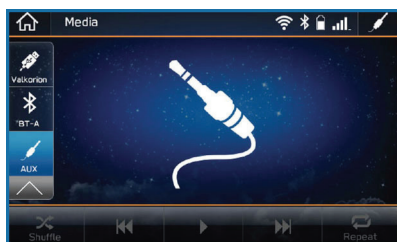

PAIRING A PHONE

To begin using your Bluetooth® Hands-free device you must first pair your phone with the system. Phone pairing provides access to the contact list on your phone and allows you to use the voice recognition system to make and receive calls. The system can also read incoming text messages, as well as allowing you to reply to texts or send short messages. The system automatically reconnects to your Bluetooth® device and will remember your driver profile.

i For instructions on how to pair your phone to the Touchscreen, see page 93 for Android devices or page 97 for Apple devices.

Visit <https://www.subaru.com/owners/index.html> for complete details on what is available by connecting a phone to the Touchscreen.



Scan to learn more about **Pairing a Phone**.

MAKING A CALL

Once your phone is paired, you can make a call through voice recognition by pressing the “Voice Recognition Switch” on the steering wheel. After pressing the “Voice Recognition Switch”, wait for the “Voice Guidance” screen to appear on the Touchscreen and say “Call [name and phone type]” or “Dial [number]”.

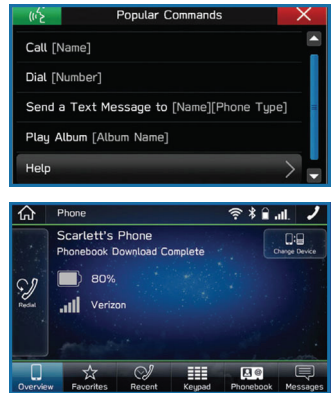

To make a call from the Touchscreen, start by pushing the “Home” button and then select “Phone”. After the phone screen displays, select the method you would like to use to make a call.

- Overview – Allows you to call the last number.
- Favorites – Allows you to place a call to one of your favorites on your phone.
- Recent – Allows you to call someone that has recently called you or that you called.
- Keypad – Allows you to dial any number you would like.
- Phonebook – Displays the phonebook from your phone.

PHONE

RECEIVING A CALL

To receive a call, press the “Talk Switch” on the steering wheel or the “Talk Button” on the Touchscreen.

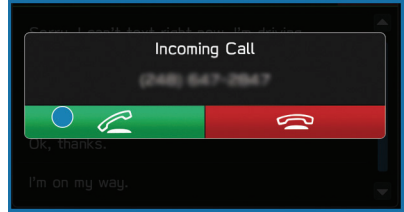

To reject a call, press the “End Switch” on the steering wheel or the “End Button” on the Touchscreen.

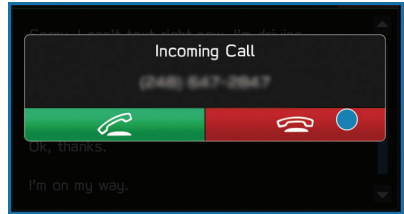

TEXT MESSAGES

Received messages can be forwarded from the connected Bluetooth® phone, enabling checking and replying using the system. To use this function, it is necessary to set the phonebook download function to ON. When a Short Message Service (SMS)/ Multimedia Messaging Service (MMS) is received, the incoming message screen pops up with sound and is ready to be retrieved using the Touchscreen. Select “Play” to listen to the message or “View” to see the message on the screen. This button may not be available if the vehicle is moving.

If there is more than one unread message, a screen will appear allowing you to either view your inbox or ignore the message.

Depending on the type of Bluetooth® phone connected, received messages may not be transferred to the message inbox. If the phone does not support the message function, this function cannot be used.

Depending on the Bluetooth® phone type, the screen display may differ, and it may not be possible to use certain functions.

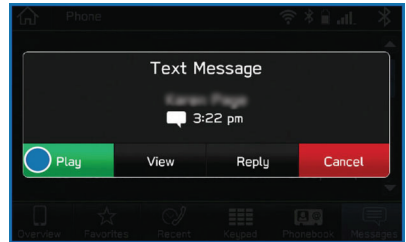

APPS

SUBARU STARLINK® IN-VEHICLE APPS

SUBARU STARLINK® Multimedia offers advanced connectivity through Apple CarPlay®, Android Auto™, aha™ and Pandora® apps. Wireless pairing and hands-free smartphone operation allow for safe and easy connection to your favorite apps and content. You can access news, navigation, music, podcasts, and more through the available SUBARU STARLINK® app.

For a complete list of all the apps available, visit www.subaru.com/engineering/starlink/multimedia.html.



Scan to learn more about **Subaru Multimedia**.

aha™ by HARMAN

aha is a cloud-based application that connects to the system and gives you access to your favorite web content safely and easily. There are thousands of available stations spanning internet radio, personalized music, audiobooks, Facebook, Twitter, restaurant and hotel searches, weather and more. For more about aha, visit www.aharadio.com.

To use the aha application, connect your iPhone or Android device via Bluetooth®. When connecting an iPhone or Android device with the aha application installed, you can control, view, and hear aha content through the system.

With the 7.0-inch Multimedia Navigation function, you may also display Points Of Interest (POI) information from the aha application on the map screen and route to these POIs.

Pandora®

Pandora is a free, personalized radio that offers effortless and endless music enjoyment. To use the Pandora application, first install the Pandora application on your smartphone. Then connect your iPhone or Android device via Bluetooth®.

NOTE: Some vehicles might be incompatible with this app depending on difference between models and software version.



Scan to learn more about **aha radio** or **to get the app**.

Android Auto™

Android Auto can be used to view maps, play music, and place calls by connecting your Android device to the system. You can also run supported applications. To use the Android Auto application, connect your Android device to the USB port.

 For more information on connecting your phone, please refer to page 101.

For details on services or operations, visit the Android Auto sites: www.android.com/auto/ or www.support.google.com/androidauto/



Scan to learn more about **Android Auto**



Scan to learn more about **Android Auto Help**

Apple CarPlay®

Apple CarPlay can be used to view maps, play music, and place calls by connecting your iPhone to the system. You can also run supported applications. To use the Apple CarPlay application, connect your iPhone to the USB port.

 For more information on connecting your iPhone, please refer to page 104.

For details on services or operations, check the Apple CarPlay site: www.apple.com/ios/carplay/



Scan to learn more about **Apple CarPlay**

SiriusXM® Travel Link

SiriusXM® U.S. satellite and data services are available only in the 48 states of the contiguous USA and DC.

Data service information, which is comprised of sports, weather, stocks and fuel prices, can be received via the SiriusXM® Radio, with the option to turn on or off weather alerts.

To receive the data service information in the vehicle, a subscription to the SiriusXM® Satellite Radio Service is necessary following a free trial.

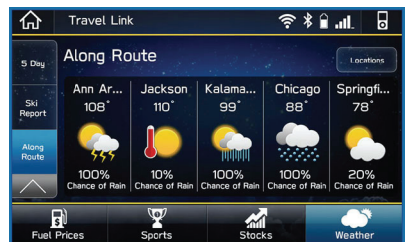

APPS

SUBARU STARLINK® MOBILE APP

There are several key applications that can be loaded to your phone and used while in your Subaru to help you while you drive. You must also download and log in to the SUBARU STARLINK® app on your phone to use these apps.

To download the SUBARU STARLINK® app, go to the Apple App Store or the Google Play Store and search for SUBARU STARLINK® in the menu.

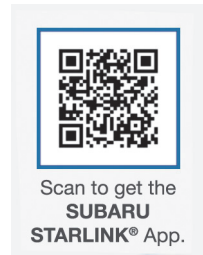
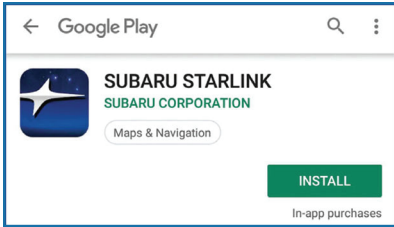

Below are a few apps that you may find helpful.

Quick Reference Guide

This is the digital version of the original printed Getting Started Guide that is standard in all new Subaru vehicles. The app features In-Vehicle Help (IVH) that provides an interactive, searchable, model-specific concierge through the Touchscreen.

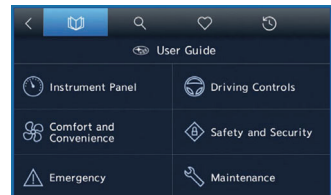
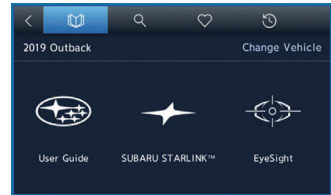

Yelp

Yelp is a local guide powered by a community of reviewers that helps you find great local businesses.

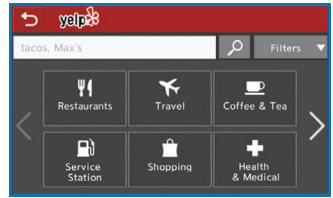

Chimani

Get the most comprehensive guide to all 417 national parks in the United States. Quickly learn about each park's history and highlights.

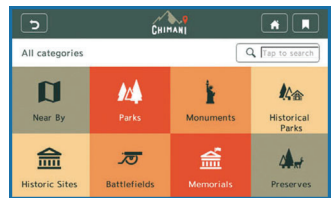

eBird

Exclusive to Subaru vehicles, the eBird app tells you what birds are being seen near you in real time. Based on a database of millions of bird sightings, eBird acts as a “digital coach” for finding birds. Use the app to decide where to go based on the distance to a great birding location and the species being seen there. For example, the app may tell you the nearest sighting of a certain species is 8 miles away and navigate you to the last place it was seen. Full-screen photos help you confirm your sightings.

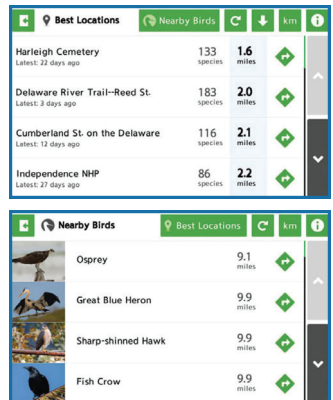

APPS

MYSUBARU

Whether you're on the road or planning adventures, the MySubaru app makes loving every part of owning your Subaru easy. Although the mobile app is great when you are on the go, you can also visit www.MySubaru.com from your computer to access the same functions and to aid in planning your trip before you leave.

You can download the MySubaru app from the Google Play Store or the Apple App Store on your phone by searching MySubaru.

By creating an account, you can:

- Schedule service with a preferred Subaru retailer
- Get vehicle service reminders, recall alerts, and exclusive coupons
- Track and record your service history
- Access resources like your owner's manuals, how to videos and more
- Have access to SUBARU STARLINK® Safety and Security features (must have an active SUBARU STARLINK® subscription)
- Get help from 24-hour roadside assistance (24-hour roadside is included in standard 3-year warranty, and after 3 years with a Concierge package)



Scan to get the
MySubaru App.

Service Appointment Scheduler

The SUBARU STARLINK® Service Appointment Scheduler can help you set an appointment from the MySubaru website, Mobile App or the vehicle's Touchscreen. Getting your Subaru vehicle to the Subaru professionals for service is easy, no matter where you are. If you are away from your preferred Subaru retailer for service, you can always use Service Appointment Scheduler to locate any of our certified Subaru retailers near your location.

STARLINK® Service Appointment Scheduler on your Touchscreen is a convenient way to set a service appointment. Simply select the MySubaru icon on the home screen and choose "Make an Appointment" to get started.

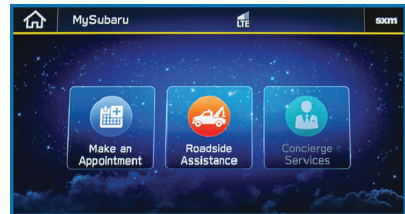

MAPS OVERVIEW

Your new SUBARU STARLINK® comes equipped with an integrated navigation system, powered by TomTom. We hope you enjoy the state-of-the-art navigation technology and optimized mapping routes to guide you on safer, better, and more enjoyable journeys.

With your integrated navigation system, you can find destinations by address or search by points of interest, as well as save destinations in the system as favorites. You can also customize route options and settings and find the nearest gas station along your route with the touch of a button.

 For more information and step by step directions on using your navigation system, please refer to page 107 or the STARLINK® Owner's Manual.

CREATING HOME AND WORK PROFILES

Creating a driver profile allows you to save your home address and work address in the navigation system for ease of use.



 For step by step instructions on creating a driver profile, please refer to page 57.

STARLINK SAFETY AND SECURITY

SAFETY AND SECURITY OVERVIEW

STARLINK® Safety and Security services* are designed to help in your time of need. These include Advanced Automatic Collision Notification, SOS Emergency Assistance, Enhanced Roadside Assistance, Stolen Vehicle Recovery, and so much more.



With the SUBARU STARLINK® system integrated into your vehicle, advanced safety and security technology is just a button press away. The SUBARU STARLINK® experience includes in-vehicle call center support, maintenance and diagnostic alerts as well as remote services that keep you connected to your Subaru vehicle.

Located in the overhead console of most Subaru vehicles are the red SOS  and blue i-button . Both buttons link you to the SUBARU STARLINK® call centers that are there to support you 24 hours a day, 7 days a week.

The SOS button  is for SOS Emergency Assistance.

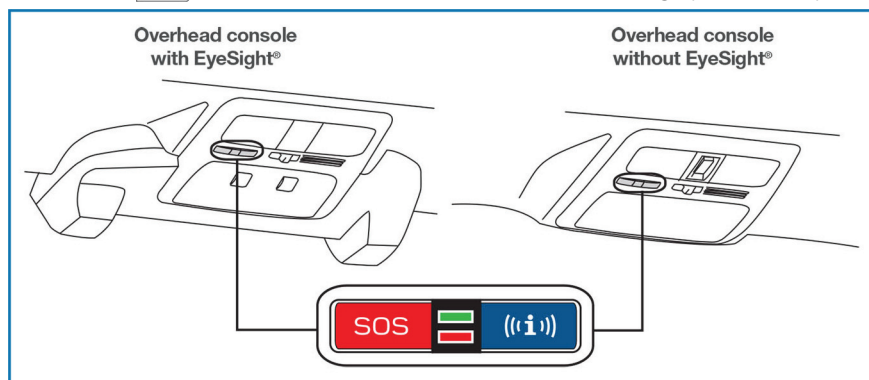
The i-button  is for Enhanced Roadside Assistance or Concierge (if subscribed).



- Press the SOS button  for SOS Emergency Assistance.*
- Press the i-button  for Enhanced Roadside Assistance* or Concierge* (if subscribed).*
- To cancel a SOS Emergency Assistance, Enhanced Roadside Assistance or a Concierge call, press and hold the same button for approximately two seconds or select the "End Call" button if displayed on the Touchscreen.

STARLINK SAFETY AND SECURITY

Head to www.Subaru.com/STARLINK to see all the SUBARU STARLINK® subscription services and packages.

* Access to STARLINK® Safety and Security services requires an active STARLINK® subscription. Remote Engine Start available on keyless access with push-button start vehicles. Remote Engine Start with Climate Control available on vehicles with keyless access with push-button start and automatic climate control. Not available on vehicles with manual transmission.



Scan to learn more
about **SUBARU
STARLINK.**

ENROLLMENT

To enroll in SUBARU STARLINK® and access remote services, a MySubaru account is required. MySubaru is the Subaru owner website that allows you to access vehicle remote services, user preferences, diagnostic alerts and other useful features enabled by your STARLINK® Safety Plus, STARLINK® Security Plus and STARLINK® Concierge subscription.

Your retailer may have created an account for you during the delivery process. However, you can also create a MySubaru account on www.mysubaru.com.

Enrollment in SUBARU STARLINK® can be done online at MySubaru.com, through the MySubaru Mobile App, at your Subaru retailer or by calling a STARLINK® Customer Care Representative at: 1-855-753-2495

NOTE: Please have your Vehicle Identification Number (VIN) available, as you will need it to complete this step. After the enrollment process, you will learn more about the features in detail at MySubaru.com.

STARLINK SAFETY AND SECURITY

MYSUBARU INTEGRATION

The connection between you and your Subaru has never been simpler, and the MySubaru website (MySubaru.com) and MySubaru Mobile Application are the best ways to stay in touch with your Subaru vehicle. From MySubaru, you can access the following information and STARLINK® Safety and Security services*:

- Remote Services
- Vehicle Health
- Usage Reports
- Service Appointment Scheduler
- Vehicle Maintenance Schedules
- Destination to Vehicle
- Service History
- Support Resources

* Internet access is purchased separately through AT&T with monthly, per gigabyte, and unlimited data options available. Existing AT&T customers have the option to add an additional line to their AT&T Mobile Share plan. Available on select models.

SUBARU STARLINK® WI-FI HOTSPOT

SUBARU STARLINK® in-vehicle Wi-Fi Hotspot keeps you and your family connected using AT&T's 4G LTE nationwide cellular network. Whether watching movies, playing games or even listening to music, your family won't miss a beat with SUBARU STARLINK® in-vehicle Wi-Fi Hotspot. Set up is quick and easy.

 For more information on a subscription and step by step enrollment instructions, please refer to page 106 or visit: <https://www.att.com/plans/connected-car/subaru.html>



Scan to learn
more about **AT&T**
Wi-Fi Hotspot

SETTINGS AND UPDATES

SETTINGS AND UPDATES OVERVIEW

Many settings can be customized for different features in your Subaru. In this section you will find examples and instructions for some of the settings you can tailor to fit your preferences, as well as ways to keep your system updated.

Connect to Home Wi-Fi

Connecting to your Wi-Fi network can allow you to update the software and maps. To connect to Wi-Fi, first go to the “Settings” screen, select “General”, and then select “Wi-Fi Settings”.

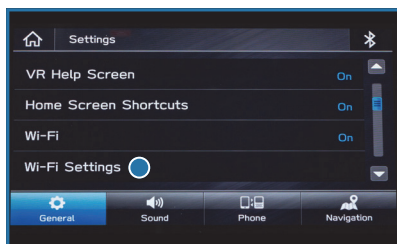

 For step by step instructions on connecting to Wi-Fi, please refer to page 105 or your STARLINK[®] Owner's Manual.

Performing Software Updates

Software updates provide enhancements to the system such as new features, added security, and upgraded functions.

You can ask your preferred Subaru retailer to update the system software. For the 7.0-inch Multimedia Plus and the 7.0-inch Multimedia Navigation systems, the system software can be updated via a Wi-Fi network or using the aha application on your smartphone (depending on your smartphone communication and transfer speed). The update process involves downloading and installing the software update.

NOTE: System functionality will be restricted during installation.

 For step-by-step instructions and more information, please refer to page 115 or your STARLINK[®] Owner's Manual.

SETTINGS AND UPDATES

SOUND

To change the sound settings, press the “Home” button, then select “Settings”, and then select “Sound”. Choose the setting you want to change.

SETTING	FUNCTION
EQ and Sound Position	Select to set sound settings.
Entertainment Volume	Select to set audio volume.
Aux Volume Gain	Select to set AUX volume gain.
Microphone Volume	Select to adjust the mic sensitivity. This adjusts the speaker's voice during hands-free communication.
Navigation Volume	Select to set the navigation prompt volume. (Navigation-equipped vehicles only).
Phone Volume	Select to adjust the default volume of the other party's voice.
Ringtone Volume	Select to adjust the ringtone volume.
Speech/VR Volume	Select to set the voice recognition prompts volume.
Alert Sounds	Select to turn the Alert Sound on/off for traffic, weather, or SXM game information updates.
Beep Sounds	Select to turn the sound beeps on/off.
Speed Volume	Select to set the speed volume. The system adjusts to the optimum volume and tone quality according to vehicle speed to compensate for increased vehicle noise.

PHONE

This system supports Bluetooth[®], a wireless data system. The hands-free system lets you make and receive calls without taking your hands off the steering wheel.

In the sound settings menu, you can adjust the microphone, ringtone, and phone volume.

On the Home Screen, select "Settings", then select the "Phone" menu to manage connected devices and access other phone settings.

SETTINGS AND UPDATES

MAPS/NAVIGATION

There are many programmable map/navigation features that can be customized. These settings are located under the "Settings" menu and then "Navigation". Listed in the table below are some common settings you can customize for your convenience.

SETTING	FUNCTION
Route Setting	Allows you to select Fastest, Shortest or Economic.
Avoid	Allows you to avoid things like highways, tolls, ferries, carpool lanes and unpaved roads.
Map Display	Allows you to change the brightness by selecting auto, day or night.
Save as Home	Allows you to input your home address.
Save as Work	Allows you to input your work address.
POI Icons	Allows you to turn the icons on/off.
Arrival Time	Allows you to select either 12 hour time or 24 hour (military) time.
Auto Zoom	Allows you to turn on/off.

Checking for Map Updates

You can update the maps to the latest information. The maps should be checked and updated regularly for the best possible navigation experience.

At www.subaru-maps.com, you can update the entire USA map at once via USB. The maps can also be updated over the air. When updating over the air, you can update eight regions at a time. This allows you to update your home state without having to download the entire map program for the United States. This option is great if you normally stay in your home state and/or surrounding states.

Updating Maps Over-the-Air

To update your maps over the air, first Connect to a Wi-Fi network (see page 105). Map updates can be found by selecting "Settings", then "Navigation" on the Touchscreen.

 For more step by step directions for updating your maps through Wi-Fi, please refer to page 113.

SETTINGS AND UPDATES

Updating Maps Using Your PC/MAC

Maps can also be updated using a USB memory device, which will allow the entire map program to be updated at one time. This is a great option if you are going to take a cross-country trip and your maps have not been updated in a while.

To update the map using a USB memory device, start by going to www.subaru-maps.com.



Scan to learn
more about
Map Updates

SETTINGS AND UPDATES

CLOCK

The clock can be set using the Enter Button on the instrument panel to operate the Multi-Function Display (MFD). To set the clock, follow the steps below:

1. Turn the ignition switch to “ON”.
2. Use the Enter Button to navigate the Multi-Function Display to the guidance screen. Then, press and hold the Enter Button to access the settings screen.

3. Select “Time/Date” and push the Enter Button.



4. Select “Date” and push the Enter Button.



5. Select the item you would like to change, and press the Enter Button to adjust the item.

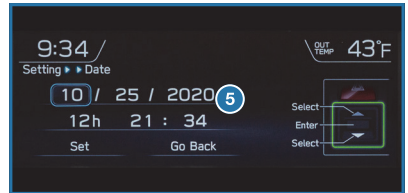

6. Select “Set” and push the Enter Button to complete your clock settings. Selecting “Go Back” will return to the previous screen without saving your settings.

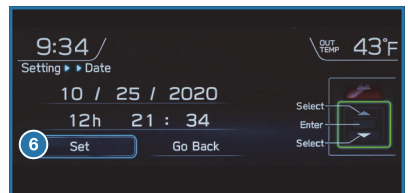

EYESIGHT

EYESIGHT® OVERVIEW

Your Subaru features a variety of safety systems that are the culmination of everything Subaru Engineers know about safety. These systems are referred to as “Driver Assist Technologies” and add confidence to every trip you and your passengers take. Working together, these systems provide enhanced awareness, safety, and convenience in front, to the sides, and behind your Subaru. Subaru Driver Assist Technologies include:

- EyeSight® Driver Assist Technology
- Rear-Vision Camera
- Pre-Collision Braking
- Blind-Spot Detection (BSD)
- Rear Cross-Traffic Alert (RCTA)
- Reverse Automatic Braking (RAB)
- High Beam Assist (HBA)
- Lane Keep Assist (LKA)
- Steering Responsive Headlights (SRH)

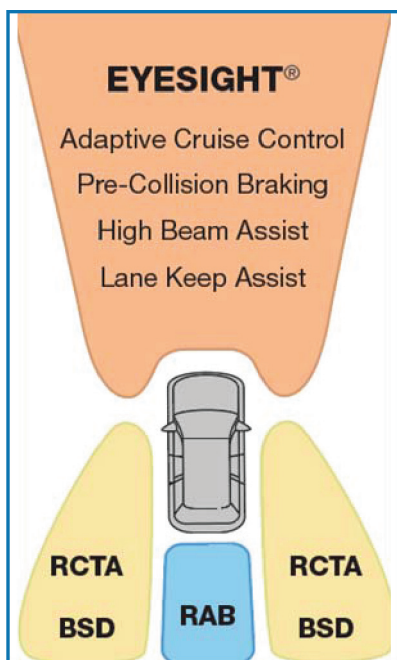

OPERATION

EyeSight® is a driver assist technology that uses dual color cameras to serve as an extra pair of eyes on the road ahead to identify vehicles in front, pedestrians, traffic lanes, or other objects. If need be, the EyeSight® system can apply the brakes and/or reduce engine power to help avoid or reduce the severity of a collision. During these events, the system will provide audible and visual alerts to assist you in making decisions.

Since the characteristics and limitations of the EyeSight® color cameras are similar to human eyes, it is important that the cameras, windshield, and area in front of the cameras are treated with special care. Please refer to “Care and Limitations” on page 90 for more details.



EyeSight Cameras (inside)



EyeSight Cameras (outside)

FUNCTIONS

The EyeSight® system features several distinct functions designed to provide extra awareness, improve safety, reduce fatigue, and add peace of mind every time you drive your Subaru. EyeSight® functions include:

- Pre-Collision Braking
- Pre-Collision Brake Assist
- Pre-Collision Throttle Management
- Lane Departure Warning
- Lane Sway Warning
- Lane Keep Assist
- Adaptive Cruise Control
- Conventional Cruise Control
- Lead Vehicle Start Alert

Pre-Collision Braking

This function helps prevent or minimize a frontal collision with another vehicle, pedestrian, or other objects by providing visual and audible warnings. Warnings are displayed in the Combination Meter Display (CMD) with audible beeps. If you take no corrective action, the system automatically reduces engine power and applies the brakes with increasing force to help prevent or minimize the collision.

This system can be turned on or off by using the Pre-Collision Braking System OFF switch (see page 86).

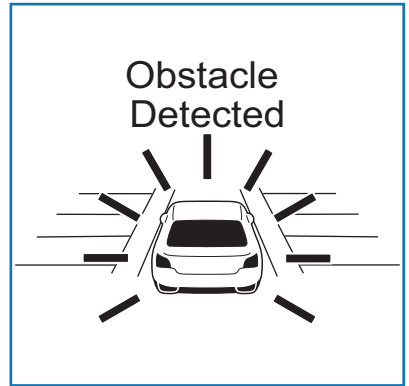

Pre-Collision Brake Assist

This function recognizes a possible collision with another vehicle, a pedestrian, or object in front while you are applying the brakes. If the system determines not enough force is applied, it can assist by applying additional pressure to the braking system to decrease stopping distance.

This system can be turned on or off by using the Pre-Collision Braking System OFF switch (see page 86).

EYESIGHT

Pre-Collision Throttle Management

This function is designed to help prevent you from unintentionally accelerating into a stopped vehicle or other obstacle by reducing engine power. Warnings are displayed in the Combination Meter Display (CMD) with audible beeps.

Pre-Collision Throttle Management is helpful when:

- You unintentionally place the select lever in the “D” position instead of the “R” position and start to accelerate toward a parked car, wall or parking structure.
- While you are at a stop, the vehicle ahead of you accelerates, but then suddenly slows down or stops as you begin to accelerate.

This system can be turned on or off by using the Pre-Collision Braking System OFF switch (see page 86).

Lane Departure Warning

This function provides audible and visual warnings if you are about to depart your lane of travel. Using the EyeSight® camera, the Lane Departure Warning function identifies lane markings when traveling at speeds of approximately 30 mph or greater. These warnings are displayed in the Combination Meter Display (CMD) with audible beeps. Lane Departure Warning does not provide any corrective actions.

You can turn this system on or off by using the Lane Departure Warning OFF switch (see page 86).

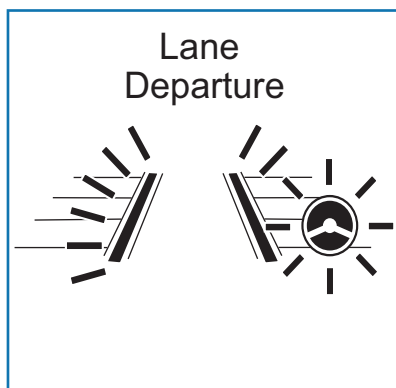

Lane Sway Warning

This function detects repetitive or unusual side-to-side vehicle movement within a lane of travel that may indicate a drowsy or inattentive driver. Using the EyeSight® camera, the Lane Sway Warning function activates to identify lane markings when traveling at speeds of approximately 37 mph or greater. Warnings are displayed in the Combination Meter Display (CMD) with audible beeps. Lane Sway Warning does not provide any corrective actions.

You can turn this system on or off by using the Lane Departure Warning OFF switch (see page 86).



Lane Keep Assist (LKA)

This function provides steering assistance to keep you in the lane of travel when driving on expressways, freeways, and interstate highways at approximately 37 mph or greater. Lane Keep Assist uses the EyeSight® camera to identify lane markings and assists steering operation to help prevent lane departure.

This function is turned on or off using the Lane Keep Assist button on the right side of the steering wheel. Once the system is turned on, a white Lane Keep Assist icon will be displayed on the Combination Meter Display (CMD). Lane marking graphics on the CMD change to white to indicate that the right and/or left lane markings have been successfully identified by the EyeSight® camera. If the vehicle is about to depart the driving lane, the system assists steering by gently guiding the vehicle back into your lane. When the system is actively providing assistance, the Lane Keep Assist icon in the CMD will change from white to green.

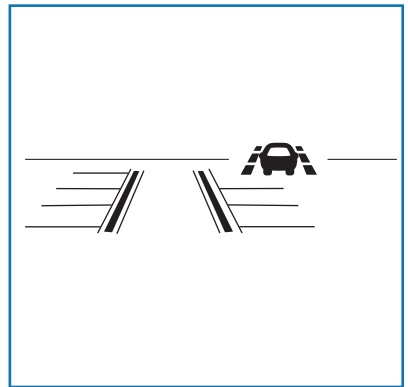

EYESIGHT

Adaptive Cruise Control (ACC)

This system provides cruise control with the ability to keep a safe distance from the car in front of you. Using the EyeSight® camera, the Adaptive Cruise Control function identifies vehicles in front of you in the same lane, and your vehicle follows the vehicle in front (up to the maximum of your set speed). While following, your vehicle will automatically maintain a following distance that corresponds to the speed of the vehicle in front. The vehicle is capable of being controlled at a speed between 0 mph and approximately 90 mph.

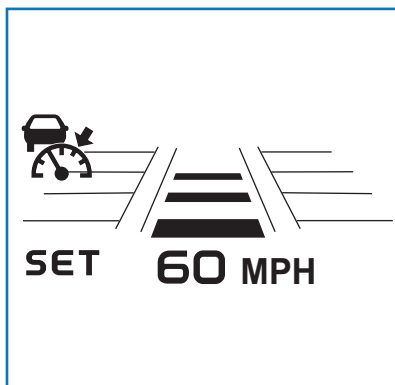

You can turn the Adaptive Cruise Control on or off using the Adaptive Cruise Control On/Off button on the right side of the steering wheel (see page 84). Once the system is turned on, a white Adaptive Cruise Control icon will be displayed on the Combination Meter Display (CMD). When all the operational conditions are met, “READY” appears underneath the Adaptive Cruise Control icon.

To set Adaptive Cruise Control, push down the “SET/-” switch on the right side of the steering wheel. The CMD will indicate a target speed and the “SET” indicator appears. This speed can be adjusted up or down using the “RES/SET” switch (see page 84).

When a vehicle in front of you is identified, a Lead Vehicle icon will be displayed on the Combination Meter Display (CMD). You can change the desired following distance from the lead vehicle by pressing the Following Distance Button (see page 84).

Conventional Cruise Control

Conventional Cruise Control maintains a constant traveling speed you set, but it does not adapt to the other vehicles in front of you. To activate Conventional Cruise Control, press the Adaptive Cruise Control On/Off button to set Adaptive Cruise Control into standby status. Then, with Adaptive Cruise Control in standby status, press and hold the Following Distance Button on the steering wheel for approximately two seconds.

The Cruise Control indicator on the Combination Meter Display (CMD) will change from the Adaptive Cruise Control icon to the Conventional Cruise Control icon, and the “READY” indicator appears when all operational conditions are met. Use the accelerator to reach the desired speed, then use the RES +/SET - switch to set the vehicle speed.

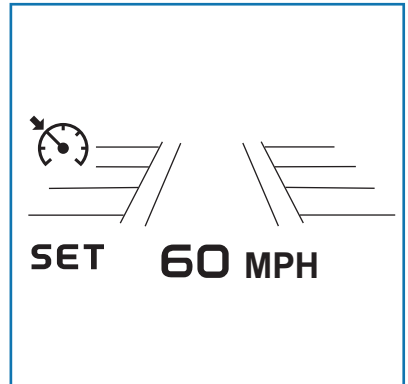

Lead Vehicle Start Alert

This function will provide a visual and audible alert when a stopped vehicle in front of you begins to move, and your vehicle remains stationary. Warnings are displayed in the Combination Meter Display (CMD) with audible beeps. Lead Vehicle Start Alert is helpful in situations where you may become temporarily distracted at a traffic light, and the vehicle ahead begins to move.

This function can be customized. To change this setting, use the steering wheel mounted “i/SET” switches to access the EyeSight® settings menu on the CMD.

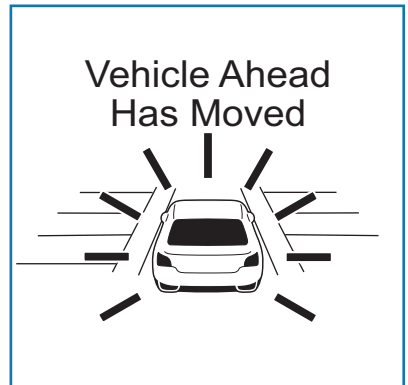

EYESIGHT

STEERING WHEEL CONTROLS

Adaptive Cruise Control

- 1 Adaptive Cruise Control On/Off:** Press to turn Adaptive Cruise Control (ACC) on or off.
- 2 Lane Keep Assist:** Press to turn Lane Keep Assist on or off.
- 3 Following Distance:** Press to set the following distance in three stages while using Adaptive Cruise Control. Press and hold to change to Conventional Cruise Control.
- 4 Resume (RES)/Increase Speed and Set (SET)/Decrease Speed:** Press the switch down to set an initial target speed. Once set, press up or down to adjust the target speed.
 - Adjust by 5 mph:
 - Briefly press the switch up to increase the target speed by 5 mph.
 - Briefly press the switch down to decrease the target speed by 5 mph.
 - Adjust by 1 mph:
 - Press and hold the switch up to increase the target speed in 1 mph increments.
 - Press and hold the switch down to decrease the target speed in 1 mph increments.



Adaptive Cruise Control Switches

Customizing EyeSight® Settings

The EyeSight® system features customization of certain preferences and warnings. Use the steering wheel mounted “i/Set” and arrow switches to navigate through the Combination Meter Display (CMD) to adjust settings such as:

- Warning Volume: Min/Mid/Max
- Lead Vehicle Acquisition Sound: On/Off

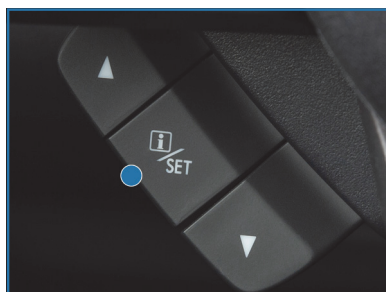

i/Set and Arrow Switches

EYESIGHT® ASSIST MONITOR (EAM) (if equipped)

The EyeSight® Assist Monitor (EAM) provides a heads-up display of EyeSight® system functions in the lower windshield area allowing you to keep your eyes on the road ahead.

The EAM indicators can be changed using the steering wheel mounted “i/SET” switches to access the EyeSight® settings menu on the Combination

Meter Display (CMD). Below are the indications provided by the EAM function:

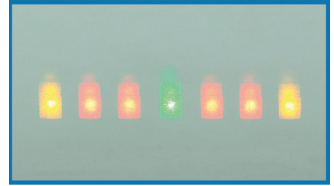

LED COLOR	PATTERN	WARNING CONDITION
Green	Solid illumination	A lead vehicle is detected ahead while Adaptive Cruise Control is operating.
Yellow	Flashing on one side	The Lane Departure Warning is operating. The side where the vehicle has left its lane flashes, and the side that has not left its lane illuminates.
	Flashing alternately	Lane Sway Warning is operating.
	Flashing simultaneously	Steering wheel operation is not be detected for a certain period of time.
Red	Flashing simultaneously (4) indicators	Following Distance Warning, Pre-Collision Braking System, Obstacle Detected Warning, or Pre-Collision Throttle Management is operating.

LANE DEPARTURE WARNING AND PRE-COLLISION BRAKING SYSTEM OFF SWITCHES

Lane Departure Warning OFF Switch

Press and hold this switch on the overhead console for two seconds to turn off the Lane Departure Warning and Lane Sway Warning functions. Press and hold the switch again for two seconds to turn the functions on.

When these functions are off, a yellow Lane Departure Warning OFF indicator will be illuminated in the Combination Meter. It may be helpful to turn these functions off when lane markings on the road are inconsistent.



Pre-Collision Braking System OFF Switch

Press and hold this switch on the overhead console for two seconds to turn off the Pre-Collision Braking, Pre-Collision Brake Assist, and Pre-Collision Throttle Management functions. Press and hold the switch again for two seconds to turn the functions on.

When these functions are off, a yellow Pre-Collision Braking OFF indicator illuminates in the Combination Meter. It may be helpful to turn these functions off when using a drive-through carwash.



DRIVER ASSIST TECHNOLOGIES

REAR-VISION CAMERA

This function provides a clear view of the area behind the vehicle to help avoid obstacles. Using a wide-angle camera mounted on the rear of the vehicle, an image is automatically displayed on the multimedia screen when you place the select lever in the “R” position. The displayed help lines, with a centerline indicator and colored distance markers, are guides to help you realize the actual distance and course from the screen image.



BLIND-SPOT DETECTION (BSD)/ REAR CROSS-TRAFFIC ALERT (RCTA) (if equipped)

This system uses radar sensors mounted behind the rear bumper on the left and right sides that warn you if another vehicle is sensed in your blind spots. These functions provide additional awareness when changing lanes or driving in reverse.

Blind-Spot Detection (BSD)

This function senses if a vehicle is in your blind spot and provides a visual warning. If the system detects a vehicle in your blind spot, the BSD/RCTA approach indicator light on the corresponding mirror illuminates.

Lane Change Assist (LCA)

Lane Change Assist (LCA) works with Blind Spot Detection to provide an additional level of warning if you attempt to change lanes with a vehicle in your blind spot. LCA will rapidly flash the corresponding side mirror indicator if you operate your turn signal when a vehicle is sensed in your blind spot.



DRIVER ASSIST TECHNOLOGIES

Rear Cross-Traffic Alert (RCTA)

This function detects a vehicle approaching from either side as you reverse and provides audible and visual warnings. The BSD/RCTA approach indicator on the outside mirror flashes, and audible beeping will sound.

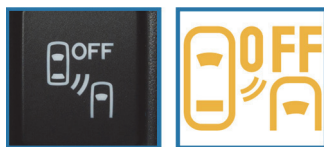

BSD/RCTA can be turned on or off by pressing the BSD/RCTA OFF switch in the instrument panel. When this function is off, a yellow BSD/RCTA OFF indicator will be displayed in Combination Meter.

HIGH BEAM ASSIST (HBA) (if equipped)

This function uses the EyeSight® cameras to automatically switch the headlights between high and low beam settings when an oncoming vehicle is detected, enhancing safety for both you and other drivers on the road.



To activate High Beam Assist, set the headlight control switch to the “AUTO” position and push the headlight lever forward to the high beam position. The green HBA indicator will illuminate on the Combination Meter. When vehicle speed is above approximately 20 mph, HBA will automatically switch between high and low beams. When the high beams are activated, the blue high beam indicator will be displayed in the Combination Meter.

STEERING RESPONSIVE HEADLIGHTS (SRH) (if equipped)

The Steering Responsive Headlights (SRH) system aims the headlight beams in the direction you are steering, improving visibility at corners and intersections when driving at night. You can turn the SRH system on or off using the steering wheel mounted “i/SET” switches to access the settings menu on the Combination Meter Display (CMD).

DRIVER ASSIST TECHNOLOGIES

REVERSE AUTOMATIC BRAKING (RAB) (if equipped)

This system uses four rear bumper mounted sonar sensors to detect objects when moving between 1 and 9 mph in reverse. RAB uses the Multi-Function Display to show colored proximity alerts when an object is detected. As an object becomes closer to the rear of your vehicle, audible beeps provide additional awareness in three progressive levels. If RAB determines that a collision with an object is possible, the system can automatically apply the brakes to help prevent or minimize the impact.

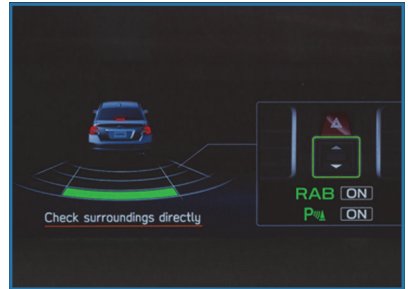

In some cases, it may be helpful to temporarily turn the system off. RAB can be turned off using the Multi-Function Display when the select lever is in the "R" position.

Select the "RAB ON" button in the Multi-Function Display and push the Enter Button to change it to "RAB OFF" to disable the automatic braking functions of the RAB system.

Select the "P))) ON" button in the Multi-Function Display and push the Enter Button to change it to "P))) OFF" to disable the audible beeping of the RAB system.

CARE AND LIMITATIONS

STEREO CAMERA PRECAUTIONS

Your EyeSight® stereo cameras are precision components that must be kept free from obstruction and contamination, such as fingerprints or cleaning solutions. When the system detects that the stereo camera lenses are impaired, a malfunction indicator will be displayed and EyeSight® functions will not be available.

When you are in the vicinity of the EyeSight® stereo cameras, always observe the following precautions:

- Do not touch or attempt to clean the EyeSight® camera lenses inside the vehicle. Extra caution should be used when cleaning the inside of the windshield. Over-spray from cleaning solutions may impair or even damage the camera lenses. Please inform others who may attempt to clean the windshield, such as car wash staff, of this precaution.
- Electronic Toll Collection devices, such as EZPass™, must be installed in an area that does not obstruct the stereo cameras' field of vision. See "Prohibited Area" on page 91.
- Adjust the rearview mirror so it does not obstruct the stereo cameras' field of vision.
- Do not install any interior rearview mirror accessories, such as a wide-type mirror or hanging objects. Only approved Genuine SUBARU accessories may be installed.

For more detailed information, please refer to your EyeSight® Owner's Manual.

WINDSHIELD GLASS AND DASHBOARD

Since the characteristics and limitations of the EyeSight® stereo cameras are similar to human eyes, it is important that the area in front of the cameras be kept free from dirt, scratches, cracks, fogging, or accessories mounted to the windshield, hood or dashboard. Visual impairments or reflections can affect EyeSight® system performance. Extra caution should be taken when cleaning the windshield to prevent over-spray from cleaning solutions.

The image in the following section outlines those areas that must be kept clean and free from obstruction. Please refer to the Owner's Manual for a complete listing of limitations.

FRONT VIEW

WRX/STI

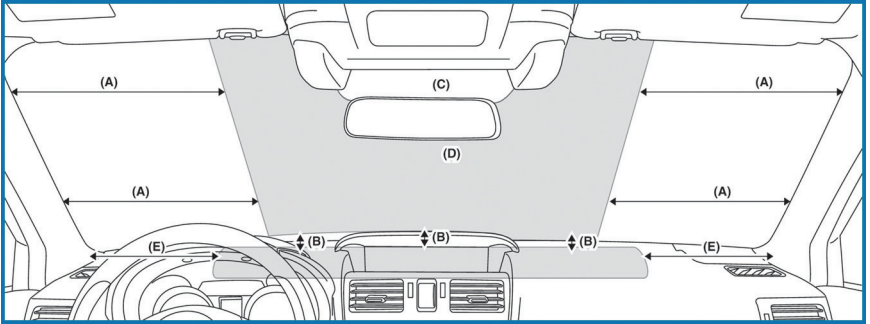

(A) 13.2 in (355 mm)
(B) 5.5 in (139 mm)
(C) 9.6 in (243 mm)

(D) Prohibited area (in gray)
(E) 7.9 in (200 mm)

EYESIGHT DISCLAIMER

EYESIGHT® DISCLAIMER

EyeSight® is a driver assist technology which may not operate optimally under all driving conditions. The driver is always responsible for safe and attentive driving. System effectiveness depends on many factors such as vehicle maintenance, weather and road conditions. See Owner's Manual for complete details on system operations and limitations.

The Pre-Collision Braking system is designed to provide automatic braking that either prevents a collision or reduces the severity of a frontal impact.

The Pre-Collision Throttle Management system is designed to reduce acceleration and minimize the severity of certain frontal impacts.

Adaptive Cruise Control and Brake Light Recognition are designed to assist the driver and are not substitutes for safe and attentive driving.

Lane Keep Assist operates only when the lane markings are visible, and system effectiveness depends on many factors.

Blind-Spot Detection, Lane Change Assist and Rear Cross Traffic Alert are systems designed to assist the driver by monitoring the rear and side areas of the vehicle during a lane change or reversing and are not a substitute for safe and attentive driving.

The Reverse Automatic Braking System is not a substitute for safe and attentive driving. System effectiveness depends on many factors, such as vehicle maintenance, weather and road conditions. Always exercise caution and use vehicle mirrors and the Rear-Vision Camera when backing up. See Owner's Manual for complete details on system operation and limitations.

HOW TO OVERVIEW

This “How To” appendix provides detailed, step-by-step instructions to easily connect with features of your WRX/STI.

If you need some help with these features or want to learn more, we are here to assist you:

Your Subaru Owner’s Manuals:

Located in the glovebox

Online Subaru Owner’s Resources:

www.subaru.com/owners

Subaru Customer Support:

www.subaru.com/customer-support

1-800-782-2783 (1-800-SUBARU3)



Scan to learn more about Owner's Resources.



Scan to learn more about Customer Support.

BLUETOOTH® PAIRING

Pairing an Android Device

1. Start by selecting “Settings” on the Home screen.

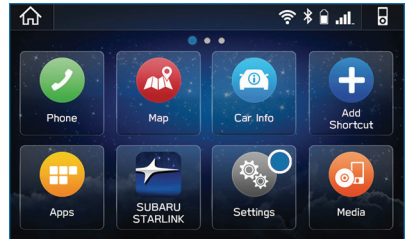

2. Select the Phone menu, then select “Add Device”.

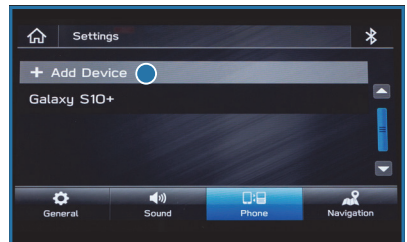

HOW TO APPENDIX

- This screen will be displayed when pairing mode is in progress. The device name will most likely be Subaru BT, but be sure to make note of what name it is, so you can find it on your phone.



- On your Android device, go to “Settings”. (It can be found under apps.) Then select “Connected Devices” or “Connections”.

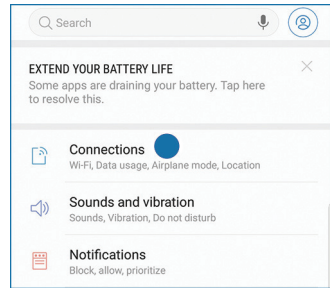
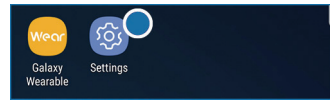

- Now select “Bluetooth”. This will show a screen to “Pair New Device” or it will be showing the nearby devices to add. Select “Subaru BT” if shown on the list or “Pair New Device”.

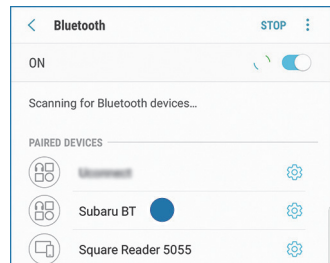
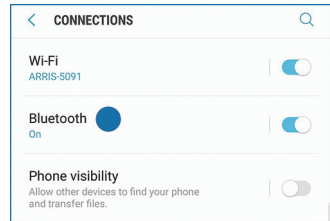

HOW TO APPENDIX

6. Now select "OK" to pair with Subaru BT and select "Confirm" on the Touchscreen if the PIN matches the phone.

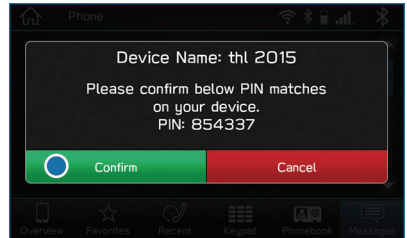
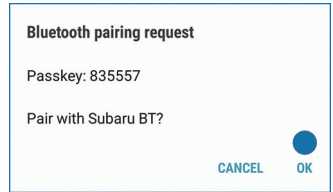

7. Make sure to allow access to your contacts and call history and select "Download" to download the phonebook contacts.

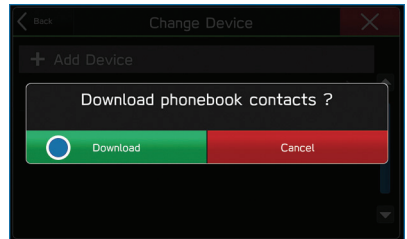
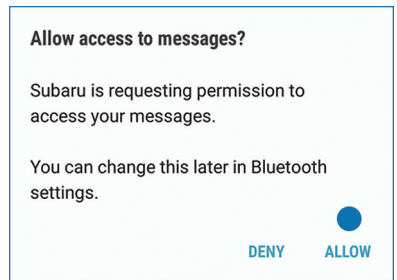

HOW TO APPENDIX

8. If your phonebook or messages are not appearing, press the “Phone” icon on the Home screen. Next, select “Change Device” in the Overview menu and ensure the “Phonebook Download” is enabled.



9. If you still cannot access your phonebook or messages, go back to your phone's Bluetooth® settings and select the gear icon next to your vehicle's device name and ensure all settings are enabled.

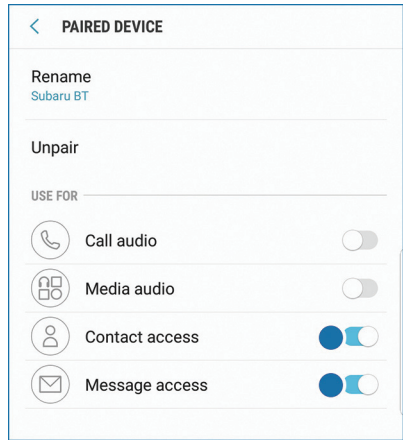

Pairing an iOS/Apple Device

1. Start by selecting “Settings” on the Home screen.

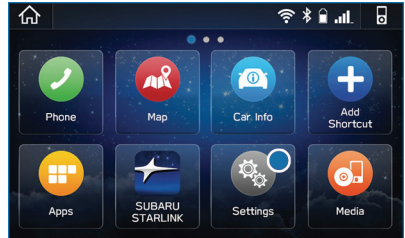

2. In the “Phone” menu, select “Add Device”.

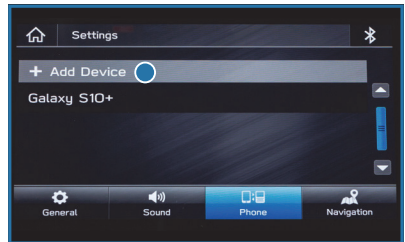

3. This screen will be displayed when pairing mode is in progress. The device name will most likely be Subaru BT, but be sure to make note of what name it is, so you can find it on your phone.



4. On your iOS/Apple device, select “Settings”. The location on the Home screen will vary.

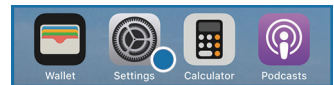

HOW TO APPENDIX

5. Select “Bluetooth”.

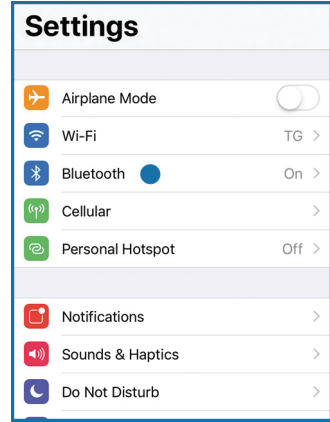

6. Now select the device name (usually “Subaru BT”) on the Touchscreen.

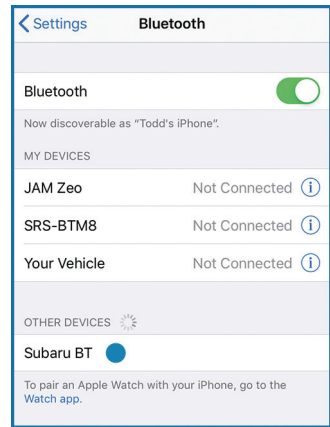

HOW TO APPENDIX

7. Verify your iOS/Apple device PIN is correct and select “Pair” on your phone and “Confirm” on the Touchscreen.

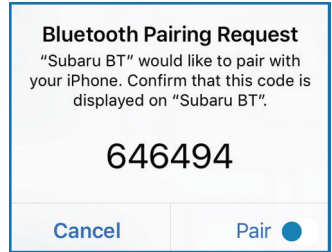

8. Select “Allow” on the “Allow Contacts and Favorites Sync?” screen, then select “Download” to download the phonebook contacts.

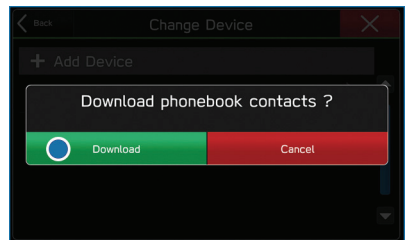
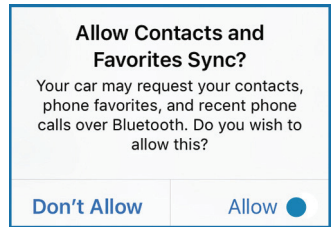

HOW TO APPENDIX

9. On your iOS/Apple device, SubaruBT should now be listed under “Bluetooth Settings”. Select the blue “i” next to the device name. Then ensure “Show Notifications” and “Sync Contacts” are enabled.

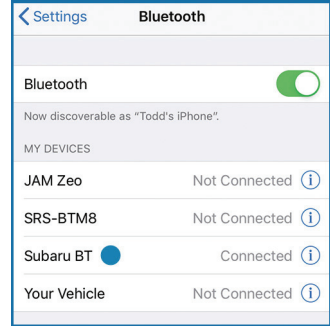

10. Your iOS/Apple device is now paired. It is recommended that you restart your Subaru to complete the process and ensure everything is fully synced.

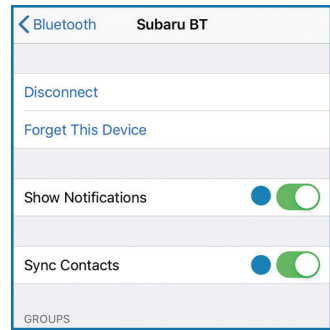

11. If your phonebook or messages are not appearing, press the “Phone” icon on the Home screen. Next, select “Change Device” in the Overview menu and ensure the “Phonebook Download” is enabled.

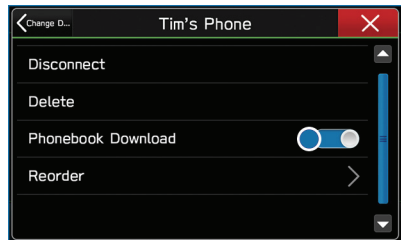
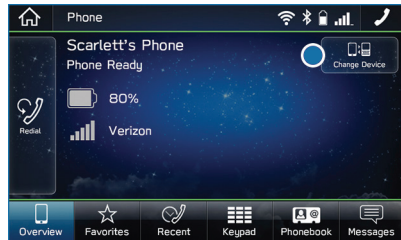

ANDROID AUTO™

Cables

Always use a high-quality OEM USB cable.

Ensure the Android phone is fully up to date. Also verify that the Android Auto app, along with all other apps that work with Android Auto, are up to date. Android Auto might not function properly if one of them is outdated or having an issue. The apps can be downloaded from the Play Store.

📍 For more information, visit: www.android.com/auto/



Scan to learn more about **Android Auto**

Connecting an Android Phone

1. To set up Android Auto, first plug the Android phone into the USB port of the vehicle using a quality OEM cable. The first time you plug in, this message will appear. Select “Accept”. After that, select “Accept” to any other prompts that appear. Android Auto might also need to download before functioning on the vehicle; allow it to do so.

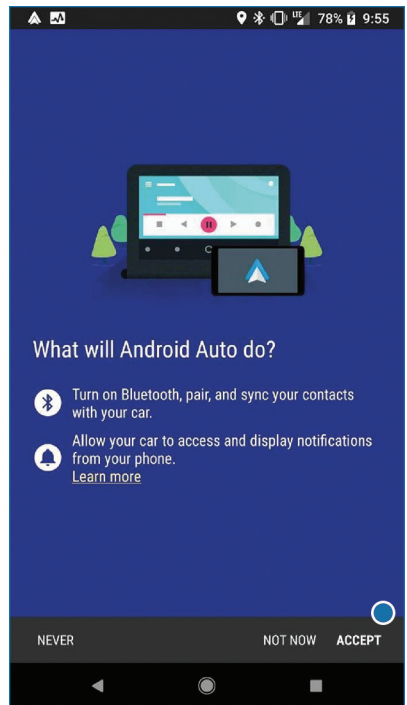

HOW TO APPENDIX

2. On the vehicle display screen, Android Auto should auto launch the first time. If not, select the Android Auto Icon on the display. Select “Show Me How” for a quick guide on using Android Auto, or select “Skip” if you want to start using the app right away.

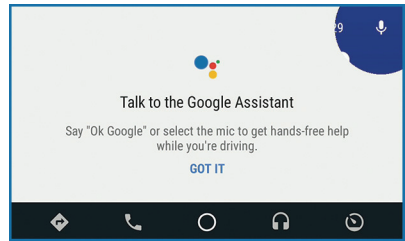
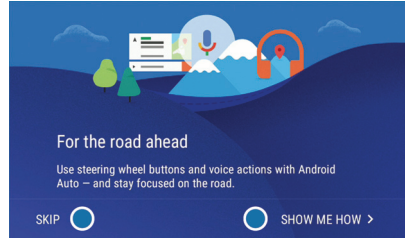

3. You will then be taken to the Home screen of the Android Auto app for your phone.

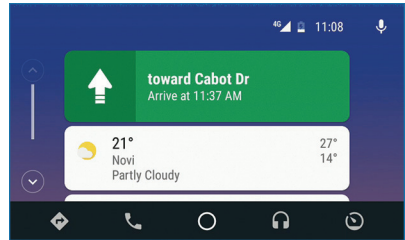

4. If Android Auto won't launch, open the Android Auto app on the phone, then select the top left menu button. Select “Settings”, then “Connected Cars”, and finally select the top right menu icon and choose “Forget all cars”.

If this does not work, uninstall the Android Auto app from the phone and reinstall from the Play Store.

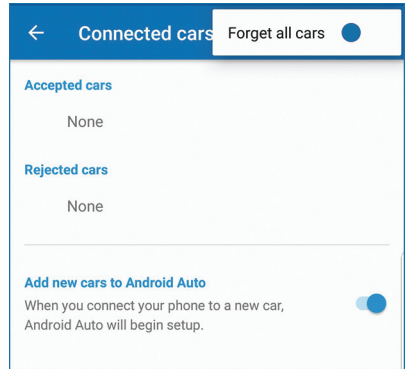

Compatible Models

Android Auto is available on Android phones. To see if your phone is compatible, please refer to the Android Auto website:

<https://www.android.com/phones/>



Scan to see if
your phone is
compatible with
Android Auto

APPLE CARPLAY®

Cables

Apple CarPlay requires compatible iPhones to be connected via your Subaru's USB port. Cables must be an 8-Pin Lightning MFi Certified cable (made for iPod/iPhone). Look for the Works with Apple CarPlay or Made for iPod, iPhone, iPad icons when selecting a cable.

 For more information, visit: www.apple.com/ios/carplay/



Scan to learn
more about
Apple CarPlay

HOW TO APPENDIX

Connecting an iPhone

1. To set up Apple CarPlay, you will need to plug the iOS/Apple phone into the USB port of the vehicle. Make sure to use an MFi certified cable.
2. Select "Allow" on the iOS/Apple phone when prompted.

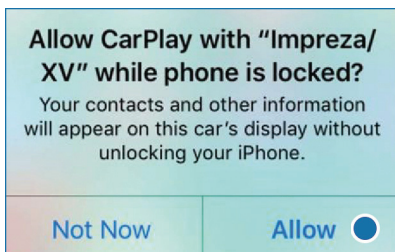

3. Select Apple CarPlay on the vehicle screen. This will bring you to the home screen of your phone in Apple CarPlay.

Ensure the iOS/Apple phone is fully up to date. Also ensure all apps that work on Apple CarPlay are up to date. Apple CarPlay might not function correctly if one of the apps is outdated or having an issue. Apps can be updated in the App Store.

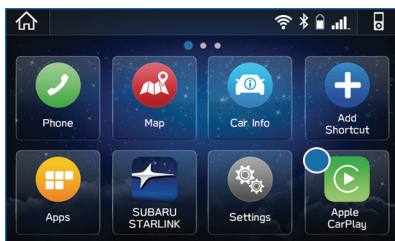

Compatible Models

For a list of all the Apple phones that are compatible with Apple CarPlay, visit: www.apple.com/ios/carplay/



Scan to learn more about Apple CarPlay

WI-FI

Connecting to a Wi-Fi Network

1. Display the General Settings screen by pressing the “Home” button, then select “Settings”. Make sure Wi-Fi is on.
2. Under the “General” tab, select “Wi-Fi Settings”.
3. Select the desired network. If the network is a secure network, a lock symbol appears on the right side of the screen.
4. Select “Connect” to connect to the network (or “Disconnect” to disconnect). “Forget This Network” deletes the network. If you are connecting to a secure network, enter the password and select “Join”.
5. Check that a confirmation message appears when the connection is complete. If an error message appears, follow the guidance on the screen to try again.

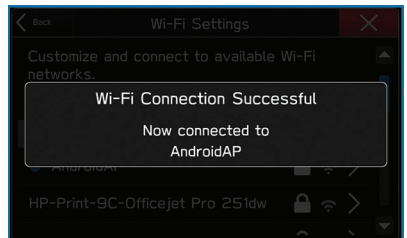
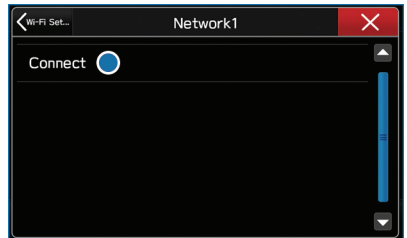
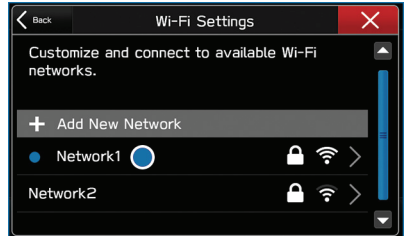

HOW TO APPENDIX

Wi-Fi Hotspot Subscription

Internet access is purchased separately through AT&T with monthly, per gigabyte, and unlimited data options available. Existing AT&T customers have the option to add an additional line to their AT&T Mobile Share plan. Available on select models.

Shortly after you take delivery of your new Subaru, you will receive an email from AT&T for a one month free trial and how to activate your free trial. To set up and enroll:

1. Select “Settings” on the Home screen.
2. Select “Wi-Fi Hotspot” to turn it on (if the Wi-Fi Hotspot is already on then proceed to the next step).
3. Select Wi-Fi Hotspot Settings to view or update the following settings:
 - Wi-Fi Network Name (SSID)
 - SSID Broadcast (Network ON / OFF)
 - Security Type (WPA / WPA2)
 - Password
 - Connected Devices (Maximum of 8 devices)

How to enroll:

1. Connect your tablet, smartphone or laptop to the SUBARU STARLINK® Wi-Fi Hotspot network listed in the settings menu and open your preferred web browser on the device connected.
2. Once the SUBARU STARLINK® Wi-Fi Hotspot homepage loads, follow the on-screen instructions to create a new account or to add your vehicle to an already existing AT&T Wireless account. You can also subscribe to the Wi-Fi Hotspot from the MySubaru website or Mobile App.

 You can also visit an AT&T store or their website for more information at:
<https://www.att.com/plans/connected-car/subaru.html>



Scan to learn
more about
AT&T plans

MAPS (if equipped)

Finding a Destination by Address

To search by address:

1. Start by pushing the “Map” button to display the map screen. Then, select “Menu”. Next select “Search for Destination Enter Address”.

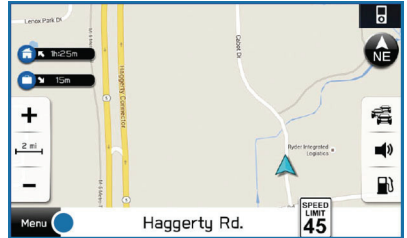

2. The keypad screen displays. As you type the address or name of the destination, suggestions will display. Select the desired destination.



3. The route calculation screen displays three recommended routes at the bottom left of the screen. Select the desired route, then select “GO”. You can also press and hold the route on the map to begin navigation.

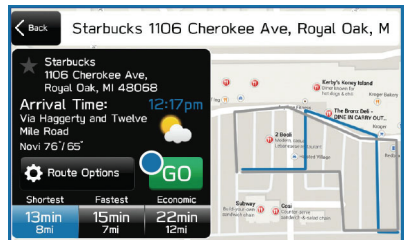

HOW TO APPENDIX

Finding a Destination by POI

To search by Points Of Interest (POI):

1. Push the “Map” button to display the map screen. Then, select “Menu”, followed by “Nearby Places List of POI”.



2. Categories are listed alphabetically. Use the scroll bar on the right, if needed, to display more categories, then make your selection.

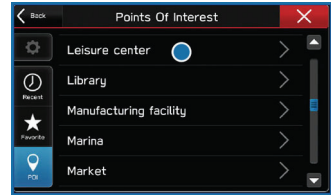
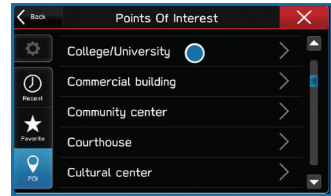

3. Select the desired item from the list, then select “GO”.

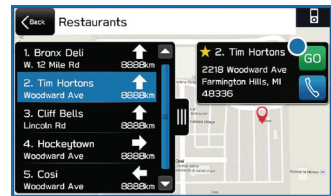

4. The route calculation screen displays three recommended routes at the bottom left of the screen. Select the desired route, then select “GO”. You can also press and hold the route on the map to begin navigation.

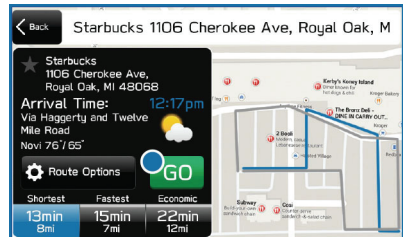

Route Options

You can set the navigation system to avoid various types of routes:

1. Select “Route Options” on the route calculation screen.
2. Select the desired item to avoid.
3. Select the check mark in the upper right corner.

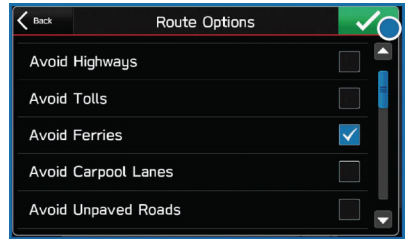

NOTE: The avoidance criteria for the route calculation can also be set from the navigation settings screen.

Shortest/Fastest/Economic

You can set the route preferences to search for the shortest, fastest, or most economic route. To do this:

1. Select “Settings” from the Home screen.
2. Select “Navigation”.
3. Select “Route Settings”.
4. Select the preference you would like to use: Shortest, Fastest, or Most Economic.

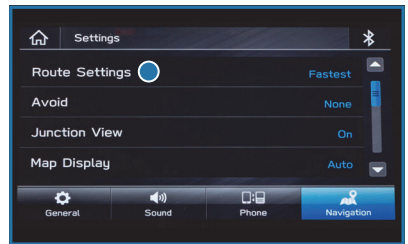

Saving Destination as a Favorite

Registered points can be set as a destination. To save a location as a favorite once you have arrived:



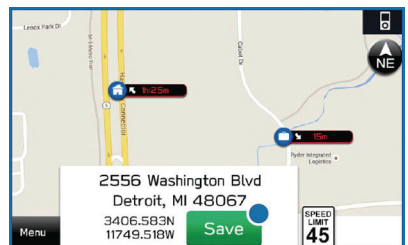













1. Select the current street name.
2. Select “Save”.
3. Select to save as Home, Work, or Favorite.



HOW TO APPENDIX

Guidance Screen Icons

The Guidance Screen Icons are the common icons used for the navigation guidance:

ICON	EXPLANATION	ICON	EXPLANATION
	Turn left.		Stay in the left lane.
	Turn right.		Stay in the right lane.
	U-Turn Left.		Straight ahead at the intersection.
	U-Turn right.		Turn left at the T junction.
	Keep left at the fork in the road.		Turn right at the T junction.
	Keep right at the fork in the road.		Go left at the roundabout.
	Turn left & sharp curve.		You are half way to your destination.
	Turn right & sharp curve.		You have arrived at your destination.

Map Zoom

Once on the map screen, you can zoom in or out by touching the “+” or “-” buttons on the screen. You can also use two fingers on the screen and move them apart to zoom in or together to zoom out.

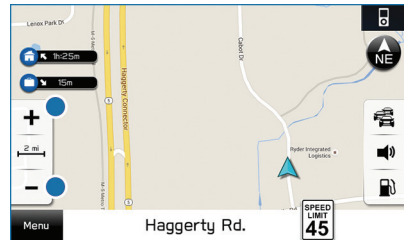

Map View/Perspective

The perspective of the map can be changed between 2D north-up, 2D heading-up, and 3D. To change the view, select the icon at the upper right of the screen. Each time the icon is selected, the view will change as well as the icon to match the map perspective.

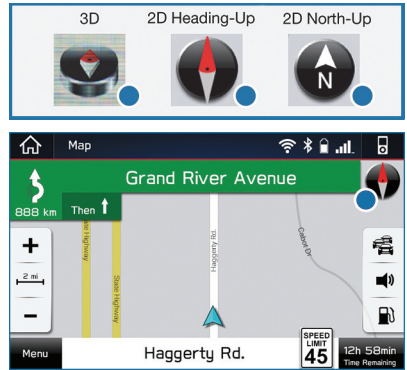

Traffic Information

Road sections affected by traffic conditions are displayed in a different color on the map, and a small icon representing the type of traffic condition is displayed above the road.

A subscription to the SiriusXM[®] Satellite Radio Service is necessary to receive the data service in the vehicle (3 years included).

HOW TO APPENDIX

Nearest Gas Station

To find the nearest gas station, select any point on the map and then select the fuel icon in the lower right corner.

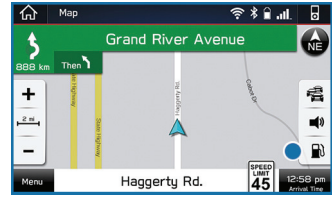

When driving on the highway during route guidance, information on gas stations, restaurants, or rest areas near the next three highway exits will be displayed.

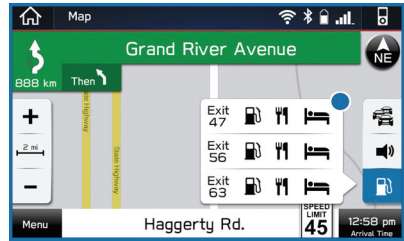

Select the desired item from the list, and then select "GO" to navigate to the closest selected place.

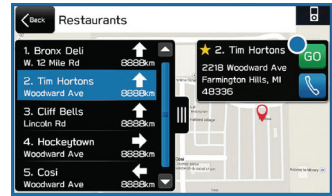

Arrival Time/Distance

Displays the distance to the destination, the estimated travel time to the destination, or the estimated arrival time at the destination. Select the information box in the lower right corner to change between modes.



Canceling Guidance

To cancel guidance, select "Menu" and then select "Cancel".

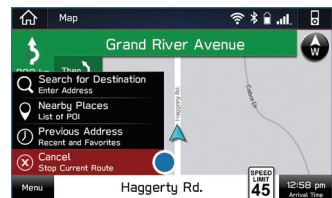

Map Updates

You can update the entire USA map at once via USB by going to: www.subaru-maps.com

Maps can also be updated over a Wi-Fi network. To update your maps via Wi-Fi, follow this process:

- 1 Connect to a Wi-Fi network. If you need help with this, see page 105.
- 2 On the Home screen, select “Settings” then “Navigation”. Next, select “Map Update” on the navigation setting screen.
- 3 Select “Select Region (Max up to 8)” to select the regions you would like to update.



Scan to learn more about **Map Updates**

- 4 Select the regions for which maps are to be updated.

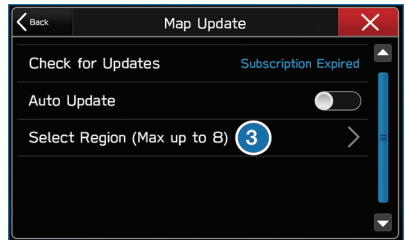

- 5 Select “Back”.



HOW TO APPENDIX

- 6 Select “Check for Updates”.

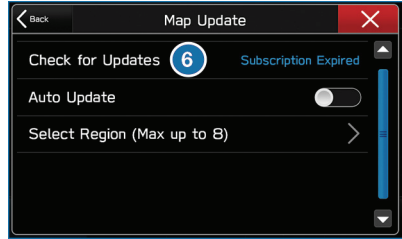

- 7 Check the confirmation message, then select “Yes”.

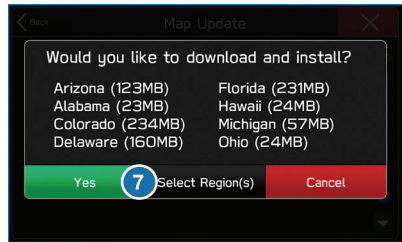

- 8 This screen is displayed simultaneously with the start of the download and installation. Select the “X” in the upper right corner if you need to stop the download and installation.

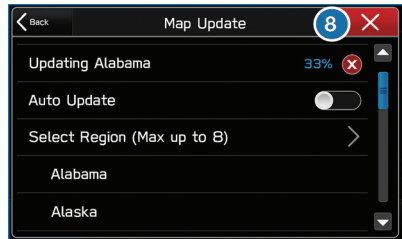

FIRMWARE AND SOFTWARE UPDATES

For 7.0-inch Multimedia Plus and the 7.0-inch Multimedia Navigation systems, you can update the system software via a Wi-Fi connection or the aha™ application on your smartphone (depending on your smartphone communication and transfer speed). The update process involves downloading and installing the software update. System functionality will be restricted during installation.

1. Connect to a Wi-Fi network or start the aha application on your smartphone (see page 105).
2. Return to the general settings screen (if needed, press the “Home” button, select “Settings”, and then select “General”).
3. Select “Check for Updates”.
 - If “Automatically Check for Updates” is turned on at the general settings screen, an update check will be performed automatically before proceeding to the next step.
 - If “Automatically Download Updates” is turned on at the general settings screen, the software update will be downloaded automatically before proceeding to “Update Installation”.
4. If the “Software Update Ready to Download” pop-up is displayed, select “Download Now” to begin the download. The download status progress is displayed in the upper right of the screen.
5. Select “Install Now” to start the installation process. The installation process will take several minutes to complete. If you need to stop the installation process, press “Cancel”.
6. When the installation is complete, select “I Agree” on the confirmation message to complete the update process. By selecting “I Agree”, the system will restart automatically.

INDEX

2.0 L ENGINE (WRX)	44
2.5 L ENGINE (WRX STI)	45

A

ACCESSORY CONNECTIONS	23
ADAPTIVE CRUISE CONTROL	25
ADDING SHORTCUTS	56
ANDROID AUTO™	101
Cables	101
Compatible Models	103
Connecting an Android Phone	101
APPLE CARPLAY®	103
Cables	103
Compatible Models	104
Connecting an iPhone	104
AUDIO CONTROLS	24

B

BLIND-SPOT DETECTION (BSD)/ REAR	
CROSS-TRAFFIC ALERT (RCTA)	87
Blind-Spot Detection (BSD)	87
Lane Change Assist (LCA)	87
Rear Cross-Traffic Alert (RCTA)	88
BLUETOOTH® PAIRING	93
Pairing an Android Device	93
Pairing an iOS/Apple Device	97
BUTTONS	49
CD Player Functions	50
Controlling the Volume	50
Other Functions	50
Radio Functions	49

C

CHILD SAFETY LOCKS	41
CLIMATE CONTROL	18
Automatic Climate Control (WRX)	18
Dual-zone Automatic Climate Control (WRX STI)	20
Heated Seats (if equipped)	22

CLOCK	77
COMBINATION METER	31
CREATING A DRIVER PROFILE	57
Retrieving a Driver Profile	58
CREATING HOME AND WORK	
PROFILES	69
CRUISE CONTROL	25

D

DRIVING THE VEHICLE	33
6-Speed Manual Transmission	33
Automatic Transmission Shift Mode (if equipped)	33
Driver Control Center Differential (DCCD) (WRX STI only)	36
Paddle Shift Control Switches	34
REV Alarm System (WRX STI only)	34
SI-Drive	35

E

ELECTRONIC PARKING BRAKE	
(EPB)	37
Auto Vehicle Hold (AVH) (CVT models — if equipped)	38
ENGINE OIL	46
ENGINE OIL CAPACITY	46
ENROLLMENT	71
ENTER SWITCH	26
EYESIGHT® DISCLAIMER	92
EYESIGHT® OVERVIEW	78
EYESIGHT® ASSIST MONITOR (EAM)	85

F

FIRMWARE AND SOFTWARE	
UPDATES	115
FOLDING THE REAR SEATS	41
FUEL	40
FUEL CAPACITY	40
FUEL FILLER LID	40

FUNCTIONS	79
Adaptive Cruise Control (ACC)	82
Conventional Cruise Control	83
Lane Departure Warning	80
Lane Keep Assist (LKA)	81
Lane Sway Warning	81
Lead Vehicle Start Alert	83
Pre-Collision Brake Assist	79
Pre-Collision Braking	79
Pre-Collision Throttle Management	80

H

HIGH BEAM ASSIST (HBA)	88
HOME SCREEN ICONS	55
HOW TO OVERVIEW	93

I

IGNITION SWITCH	32
IMPORTANT SAFETY INFORMATION	4
IN CASE OF EMERGENCY	5
Subaru Roadside Assistance	5
SUBARU STARLINK® Safety and Security	5
INSTRUMENT PANEL SWITCHES	24
INTERNAL SAFETY TRUNK RELEASE WITH SELF-ILLUMINATING HANDLE	42
I/SET SWITCH	26

K

KEYLESS ACCESS WITH PUSH BUTTON START	8
Locking Using Door Handles	8
Unlocking the Trunk	9
Unlocking Using Door Handles	8
KEYLESS ENTRY	7

L

LANE DEPARTURE WARNING AND PRE-COLLISION BRAKING SYSTEM	
OFF	86
Lane Departure Warning OFF Switch	86
Pre-Collision Braking System OFF Switch	86
LATCH/ANCHOR	42
LIGHT CONTROLS	27
Daytime Running Lights	28
Illumination Brightness	27

M

MAKING A CALL	61
MAPS	107
Arrival Time/Distance	112
Canceling Guidance	112
Finding a Destination by Address	107
Finding a Destination by POI	108
Guidance Screen Icons	110
Map Updates	113
Map View/Perspective	111
Map Zoom	110
Nearest Gas Station	112
Route Options	109
Saving Destination as a Favorite	109
Shortest/Fastest/Economic	109
Traffic Information	111
MAPS/NAVIGATION	75
Checking for Map Updates	75
Updating Maps Over-the-Air	75
Updating Maps Using Your PC/MAC	76
MAPS OVERVIEW	69
MEDIA	60
Aux Input	60
Bluetooth®	60
CD	60
USB / iPod	60

INDEX

MYSUBARU	68
Service Appointment Scheduler	68
MYSUBARU INTEGRATION	72

N

NEW VEHICLE BREAK-IN	46
--------------------------------	----

O

OPERATION	78
OVERHEAD PANEL	29
OVERVIEW OF YOUR MULTIMEDIA SYSTEM	49
Various Systems	49
OWNER'S RESOURCES	4

P

PAIRING A PHONE	61
PHONE	74
POWER EXTERIOR MIRRORS	14
POWER MOONROOF	17
Sliding the Moonroof	17
Tilting the Moonroof	17
POWER WINDOWS	16
PUSH-BUTTON IGNITION SWITCH	32

R

RADIO	59
AM/FM Radio	59
Presets	60
Satellite Radio	59
REARRANGING ICONS	55
REAR VIEW MIRROR	15
Auto-dimming Mirror	15
HomeLink® 5 Accessory Mirror	15
REAR-VISION CAMERA	87
RECEIVING A CALL	62

REVERSE AUTOMATIC BRAKING (RAB)	89
ROOF RAIL CAPACITY	47

S

SAFETY AND SECURITY OVERVIEW	70
SEATING	12
Head Restraint Adjustment	13
Manual Seats	12
Power Driver's Seat (if equipped)	12
Seatbelt Adjuster	13
SETTINGS AND UPDATES OVERVIEW	73
Connect to Home Wi-Fi	73
Performing Software Updates	73
SOUND	74
SPARE TIRE AND JACK	43
STARTING THE VEHICLE	32
Without Push-button Ignition	32
With Push-button Ignition	32
STEERING RESPONSIVE HEADLIGHTS (SRH)	88
STEERING WHEEL CONTROLS	52
Adaptive Cruise Control	84
Customizing EyeSight® Settings	84
STEREO CAMERA PRECAUTIONS	90
SUBARU STARLINK® IN-VEHICLE APPS	64
aha™ by HARMAN	64
Android Auto™	65
Apple CarPlay®	65
Pandora®	64
SiriusXM® Travel Link	65
SUBARU STARLINK® MOBILE APP	66
Chimani	67
eBird	67
Quick Reference Guide	66
Yelp	67
SUBARU STARLINK® WI-FI HOTSPOT	72

T

TEXT MESSAGES	63
TILT AND TELESCOPIC STEERING	
COLUMN	14
TIRE PRESSURE MONITORING SYSTEM (TPMS)	48
TOUCHSCREEN	51
TOWING YOUR ALL-WHEEL DRIVE	
SUBARU	6
TRAILER TOWING CAPACITY	47
TURNING OFF THE VEHICLE	39
Without Push-button Ignition	39
With Push-button Ignition	39
TURN SIGNALS	28

V

VOICE RECOGNITION	53
Common Commands	54
Tips	53

W

WARNING AND INDICATOR LIGHTS	31
WELCOME	4
WI-FI	105
Connecting to a Wi-Fi Network	105
Wi-Fi Hotspot Subscription	106
WINDSHIELD GLASS AND	
DASHBOARD	90
WINDSHIELD WIPERS	28
WRX/STI	91

Subaru of America, Inc.
One Subaru Drive
Camden, NJ 08103-9800



MSA5B2105A
Issued January 2021
Printed in USA 01/21

