

KIT CONTENTS:

Activity Mount

Driver Side Plate

Passenger Side Plate

Blocker Plate (2)

Hardware Kit

- 8 M12-1.25 x 35 Hex Bolt
- 8 M12 Conical Toothed Washer
- 1 U Shaped Edging

Customer Care Card

TORQUE EXTENSION CALCULATOR*

Formula: $\frac{TA \times L}{L + A} = TW$

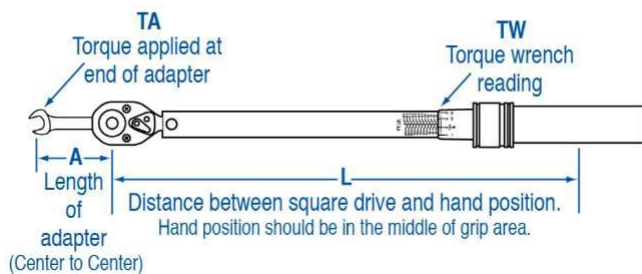



SUBARU

INSTALLATION INSTRUCTIONS

PART NUMBER: PT97442231

DESCRIPTION: Activity Mount

TOOLS REQUIRED:

Cut Resistant Gloves

Flat Blade Screw Driver

Torque Wrench- 0-100 lbf-ft

Tin Snips- For cutting bumper

3/8" drive socket wrench-14mm

3/8" drive socket – 19mm

¼" drive socket

19mm end wrench

DESCRIPTION
Activity Mount Assembly





ISSUE
00

DATE
04/12/22

SUBARU OF AMERICA

PAGE
2 / 22

MEANING OF CHARACTERS:

-  STOP: Damage to the vehicle may occur. Do not proceed until process has been complied with.
 -  STOP: Damage to the vehicle may occur. Do not proceed until process has been complied with.
 -  CAUTION: A process that must be carefully observed to reduce the risk of damage to the accessory/vehicle and to ensure a quality installation
 -  SAFETY TORQUE: This mark indicates that torque is related to safety.
-

INSTRUCTIONS:

Push Pin
Removal Tool

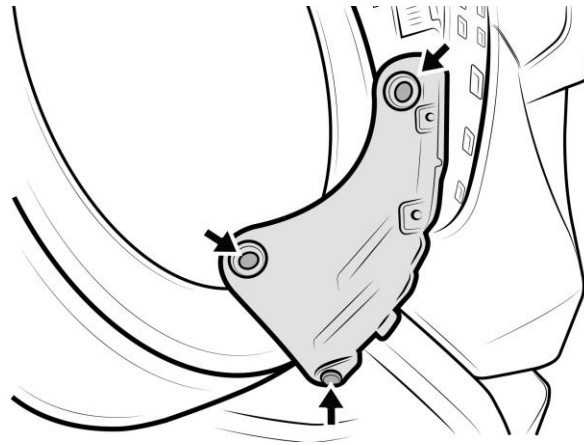

Fig 2-1

1. Preparation

-  (a) Wear safety glasses
- (b) Verify the kit contents.
- (c) Lift Vehicle to comfortable working height
- (d) Disconnect Battery

Fig 2-2

2. Remove Rear Bumper Side Seal LH/RH

- (a) Remove 2 push pins & 1 bolt (Fig. 2-1)
- (b) Repeat on RH
- (c) Add tape to lower bumper before wheel arch removal for protection.

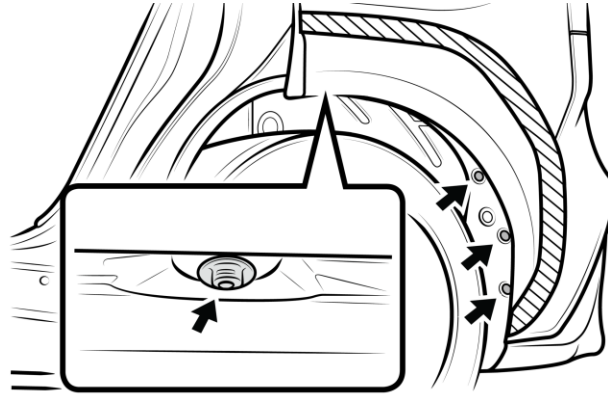

Fig 3-1

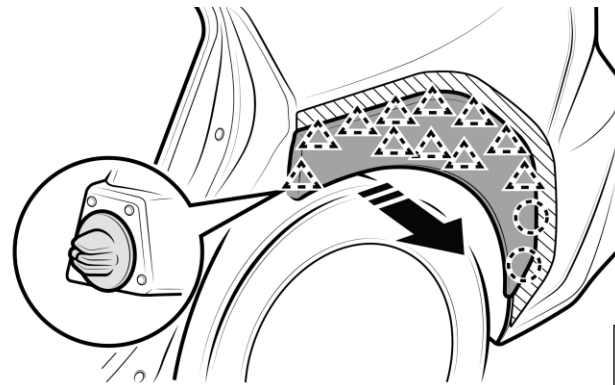



Fig 3-2

3. 3. Remove Rear Wheel Arch Molding LH/RH

- (a) Open Rear Door
- (b) Remove 10mm screw and 2 push pins and plastic Nut from LH sides (Fig. 3-1)

 Note** When removing lower tabs may damage paint on vehicle
Note** First and last clip do not have gasket.

- (c) Disengage clips by pulling in direction of arrow (Fig. 3-2)
- (d) Repeat on RH side

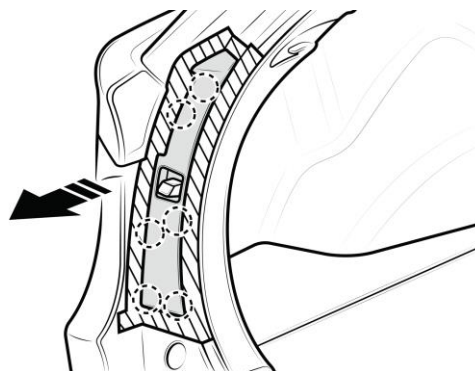

Fig 4-1

4. Remove Rear Combination Light Cover LH/RH

- (a) Disengage the claws to remove LH cover (Fig. 4-1)
- (b) Repeat on RH side

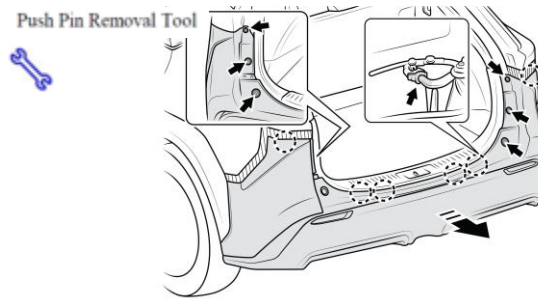

Fig 5-1

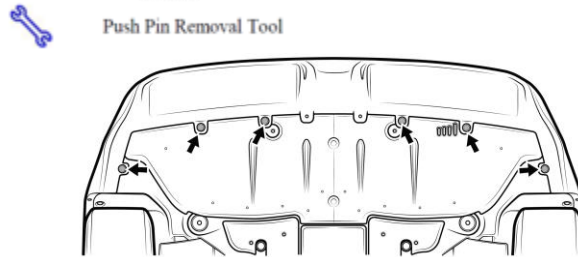

Fig 5-2

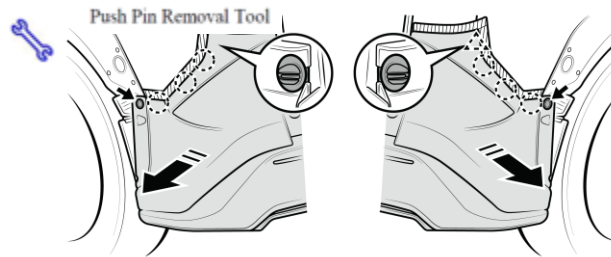

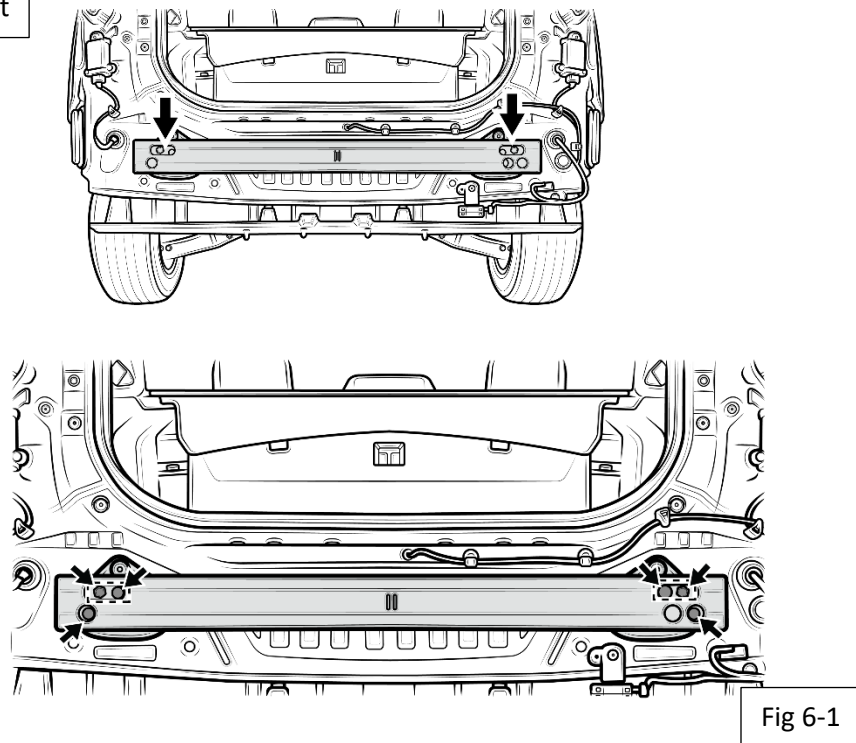

Fig 5-3

5. Remove the Rear Bumper Assembly

- (a) Remove tow hook and discard.
- (b) Remove 2 upper push pins (1 on LH, 1 on RH side). (Fig. 5-1).
- (c) Remove 4 screws (2 on LH, 2 on RH side) in middle and lower locations. (Fig. 5-1).
- (d) Remove 2 push pins (1 on LH, 1 on RH side) as show in red. (Fig. 5-2).
- (e) Remove 6 push pins from underneath vehicle (Fig. 5-2)
- (f) Disengage clips by gently pulling in direction of arrow (Fig. 5-3).
- (g) Then gently pull bumper to disengage claws
-  (h) Before complete removing bumper disconnect the wire harness for parking support brake system. (Fig. 5-3)
- (i) Place removed bumper on protective cloth to avoid scratches

 14mm Socket



6. Remove Bumper Beam Assembly and discard

(a) Remove (6) 14mm bolts from the bumper bar Remove and discard bumper beam. (Fig. 6-1).



14mm Socket

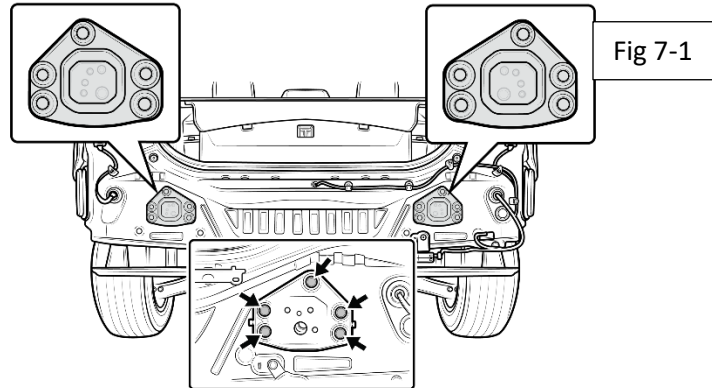

Fig 7-1

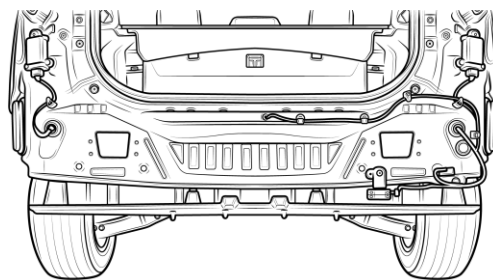

Fig 7-2

7. Remove Bumper Beam Supports LH/RH

- (a) Once Bumper Beam is removed, remove 10 14mm Bolts (5 on LH, 5 on RH) from the bumper beam supports that sit behind the bumper beam. Then fully remove and discard the LH and RH Bumper Beam Brackets. (Fig. 7-1)
- (b) Be sure to keep the bolts removed in this step for installation of the blocker plates.
- (c) Bumper Beam and Support Disassembly should look like (Figure 7-2).

Flat Head Screw Driver



Flat Head Screw Driver

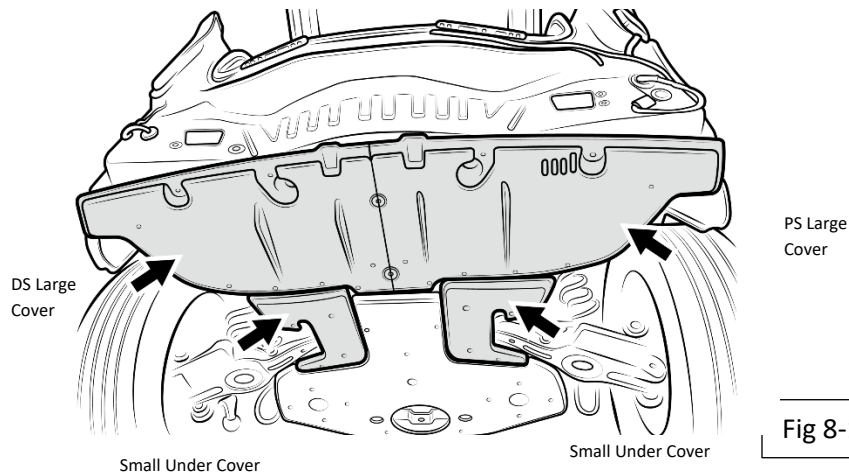

8. Remove Under Covers

- (a) Using a flat head driver remove 6 plastic push pins on larger under body (2 Pieces). (Fig 8-1)
- (b) Using a flat head driver remove 2 plastic nuts on smaller under body (2 Pieces), push in and unscrew. (Fig 8-1)

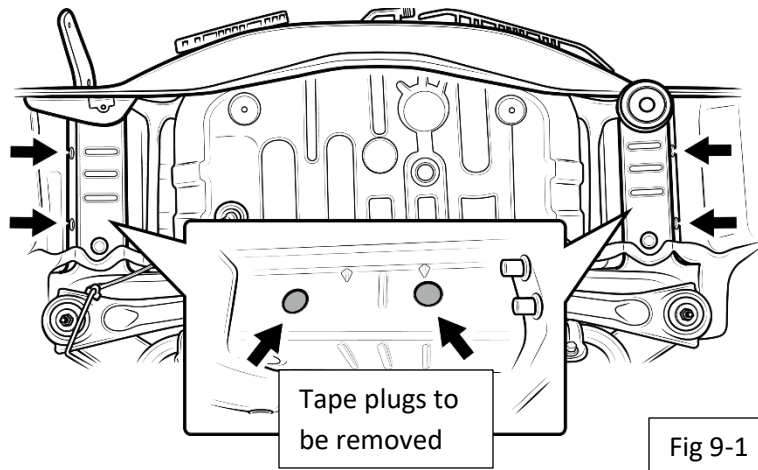

9. Removal of Tape Plugs

- (a) Remove 4 tape plugs (2 on LH and 2 on RH) on side surfaces outboard. (Fig 9-1)



SUBARU

INSTALLATION INSTRUCTIONS

PART NUMBER: PT97442231

DESCRIPTION: Activity Mount

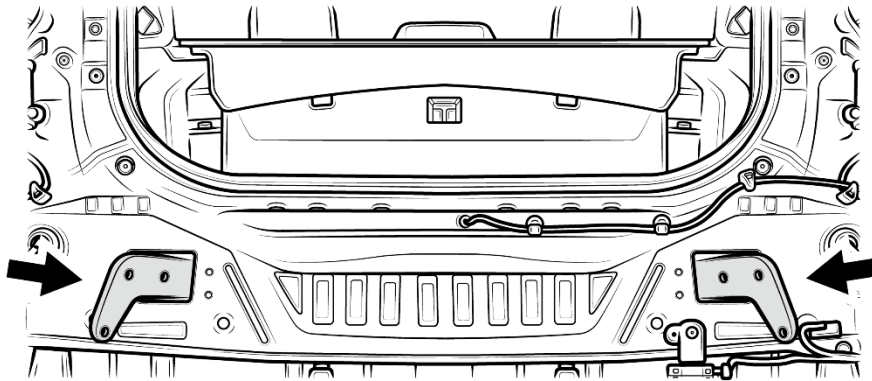
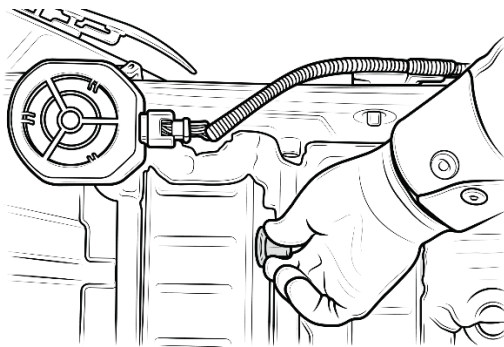
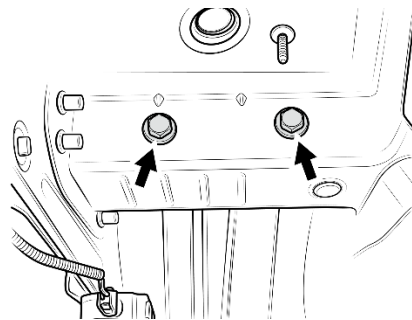

Fig 10-1



Bottom View



Side View

Fig 10-2

10. Install Side Plates

(a) Insert side plates LH and RH brackets into the side frames. (Fig.10-1)

(b) Hand tighten the M12 bolts so the brackets are flush to the frame rail. Figure 10-2.

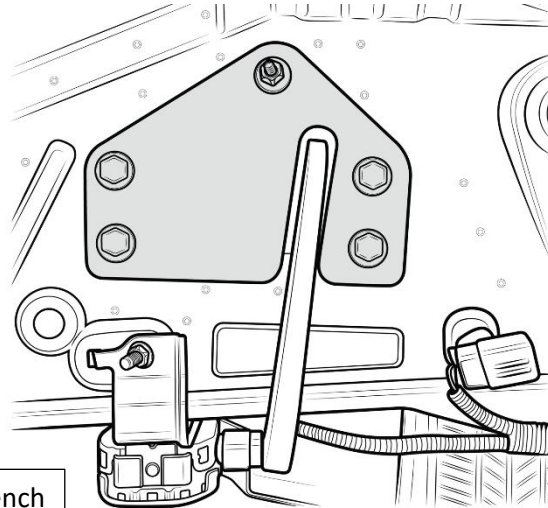



Fig 11-1

 14mm socket and torque wrench

11. Install the closeout plates LH/RH

- (a) Using the (10) 14mm bolts, removed from the bumper beam support in step 7, install the LH and RH close out plates. (Fig. 11-1)
- (b) Torque the bolts to 18 Nm (13 ft-lbs).

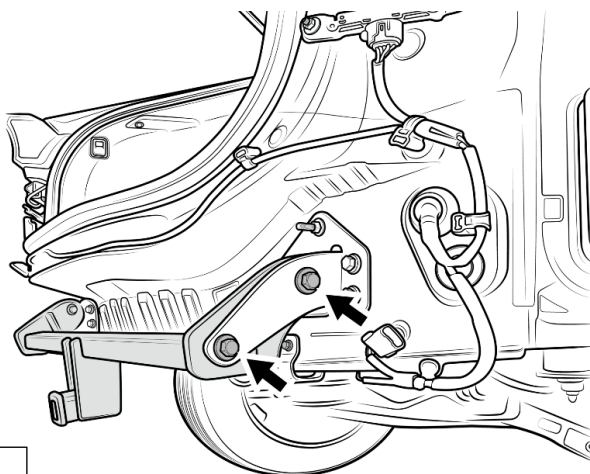

Fig 12-1



14mm socket
 and torque wrench

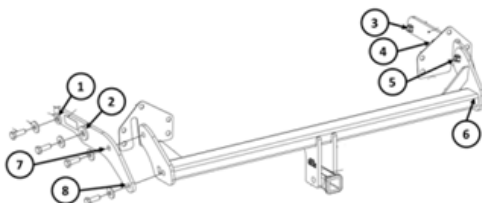

Fig 12-2

12. Install Hitch

(a) Lift tow hitch into position in between the two frame brackets. Visually align the holes with the holes in the brackets.

(b) Install (2) 14mm bolts through the framebrackets into the hitch bracket weld nuts on both the LH and RH sides (Fig. 12-1).



(c) Torque each 14mm bolt to 100Nm (74 ft-lbs) (including side plate 19mm bolts on step 10).

(c) See Torque Sequence in Fig 12-2.

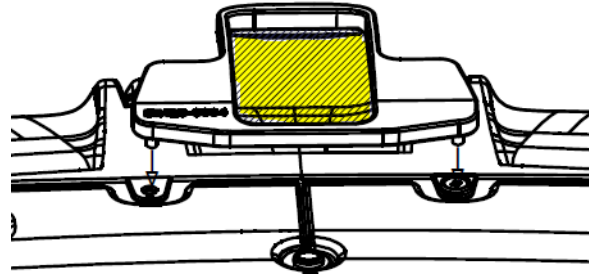
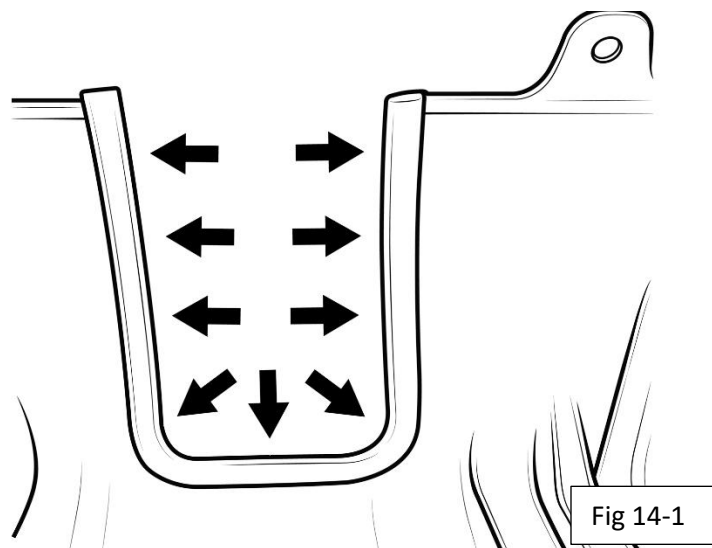

Fig 13-1

13. Trim Bumper

- (a) Protect the A surface of the bumper by placing a soft rag between hard surface where A surface of bumper will lay for trimming.
- (b) With the A surface facing down locate the B surface location where the trimming will occur
- (c) Using the template locate the two datum points and align the template to the two datums.
- (d) Trace cut out area (in yellow) using template (Fig 13-1)
- (e) Using tin snips cut to cut into the plastic



14. Assembly Weather Strip

- (a) Apply weather strip starting from the back edge of the cut out.
- (b) Slowly, Apply even pressure all the way around the edge trim.
- (c) Visually confirm that weather strip has been fully seated.
- (d) Cut any excess trip off back of weatherstrip. (Fig 14-1)



SUBARU

INSTALLATION INSTRUCTIONS

PART NUMBER: PT97442231

DESCRIPTION: Activity Mount

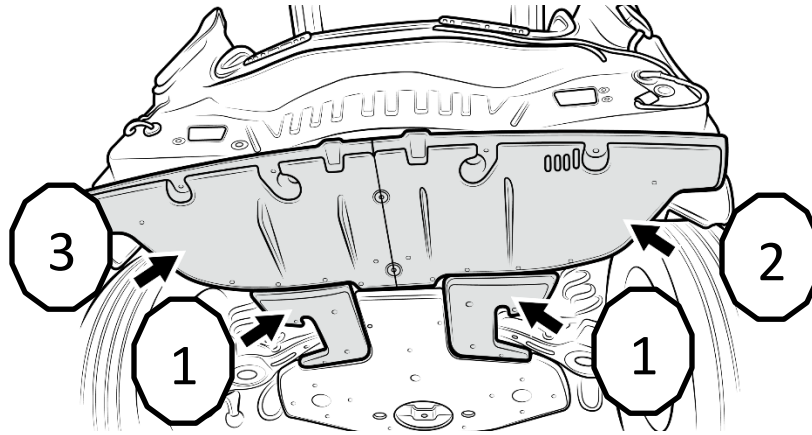

Fig 15-1

15. Reinstall Undercovers

(a) Reinstall all 4 undercovers.

- (1) Install the 2 smaller pieces first
- (2) Install Large Passenger Undercover
- (3) Install Larger Driver Side Undercover



Push Pin Removal Tool

DESCRIPTION
Activity Mount Assembly

ISSUE
00

DATE
04/12/22

SUBARU OF AMERICA

PAGE
17 / 22

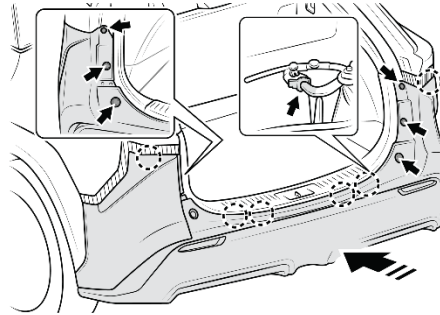

Fig 16-1

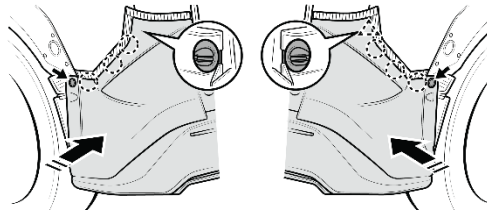

Fig 16-2

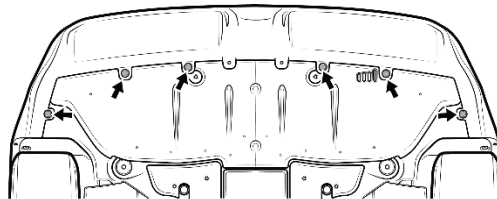





Fig 16-3

16. Reinstall Rear Bumper Assembly

- (a) Reconnect the wire harness for parking brake support system. (Fig 16-1)  
- (b) Conduct push/pull check on connector to ensure connector is seated. 
- (c) Re-engage all clips by pushing forward bumper assembly. (Fig 16-1)
- (d) Reinstalled 4 screws (2 on LH, 2 on RH side) in middle and lower locations. (Fig. 16-1)
- (e) Reinstall 2 upper push pins (1 on LH, 1 on RH side). (Fig. 16-1) (Re-engage clips on side of bumper by pushing in direction of arrow. (Fig.16-2)
- (f) Reinstall 2 push pins (1 on LH, 1 on RH side) as show in red. (Fig. 16-2)
- (g) Reinstall 6 push pins from underneath vehicle. (Fig. 16-3)

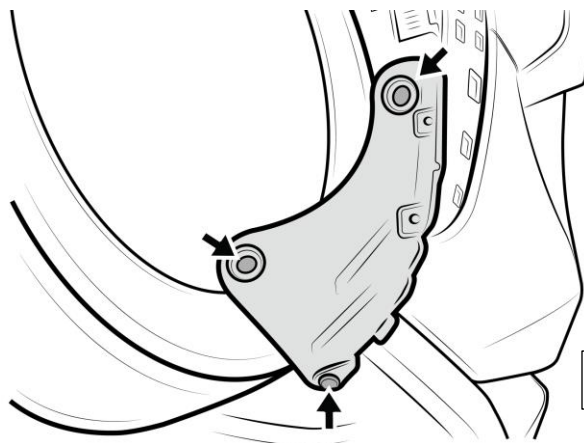

Fig 17-1

17. Reinstall Rear Combination Light Cover

LH/RH

(a) Reinstall 3 push pins (Fig 17-1)(Fig. 17-1)

(b) Repeat on RH side

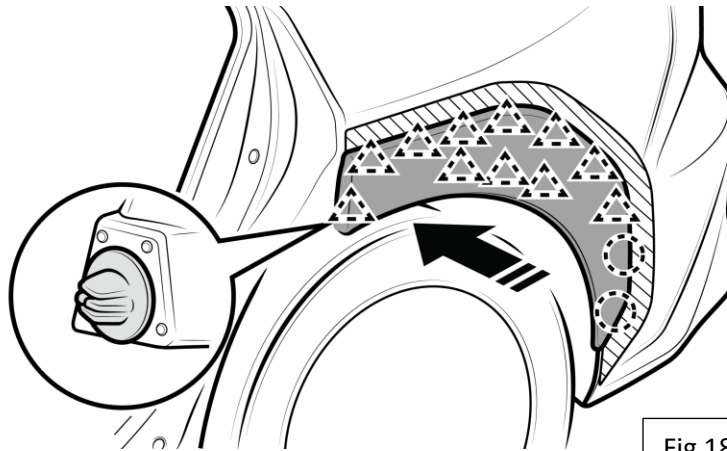

Fig 18-1

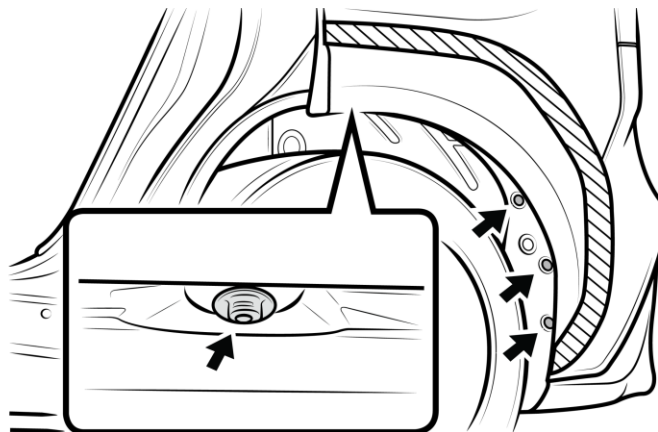

Fig 18-2

18. Reinstalled Rear Bumper Side Seal LH/RH

(a) Re-engage LH side clips by pushing in direction of arrow (Fig. 18-1)

(a) (b) Reinstall screw and 3 push pins from LH side (Fig. 18-2)

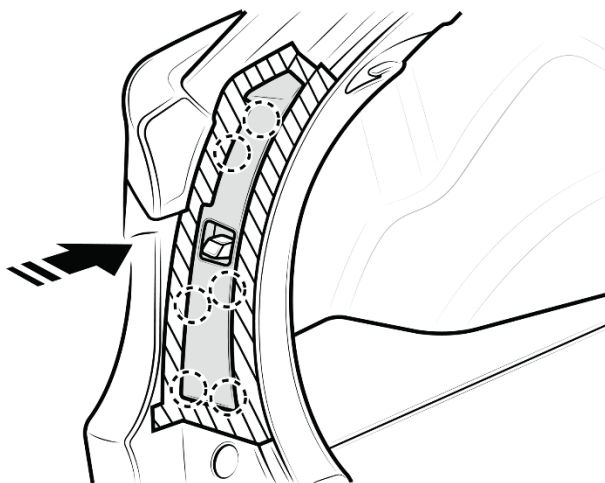

Fig 19-1

19. Reinstall Rear Wheel Arch Moulding LH/RH

- (a) Re-engage the claws to install LH cover.(Fig.19-1)
- (b) Repeat on RH side



SUBARU

INSTALLATION INSTRUCTIONS

PART NUMBER: PT97442231

DESCRIPTION: Activity Mount

20. Care Card Placement

- (a) Locate care card provided in package
- (b) Place care card in center console

DESCRIPTION	ISSUE	DATE	SUBARU OF AMERICA	PAGE
Activity Mount Assembly	00	04/12/22		22 / 22



SUBARU

INSTALLATION INSTRUCTIONS

PART NUMBER: PT97442231

DESCRIPTION: Activity Mount

21. Complete the installation.

(a) Remove vehicle protection.