



SUBARU

Part number:
Numéro de pièce:
Vehicle:
Véhicule:

J201SAN000
2020 OUTBACK / LEGACY

Installation instructions
Instructions d'installaiion

Description: Exterior auto dimming mirror with approach lighting
Description: Rétroviseur extérieur à antiéblouissement automatique avec éclairage d'approche

Kit contents

Contenu de la trousse

A

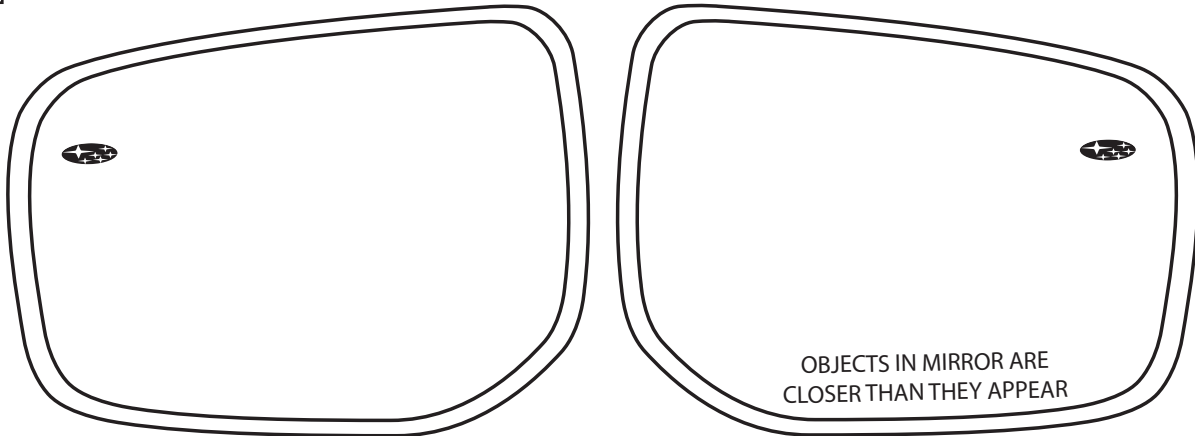

Auto dimming mirror
Tetroviseur antiéblouissement

B

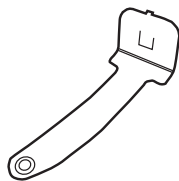

Friction Damper Spring
Ressort amortisseur à friction

2X

C



Grease Pack
Nécessaire de lubrification

Tools required
Outils requis



10 mm



12 mm

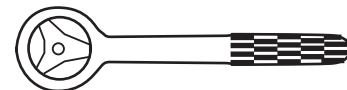

PART NUMBER
J201SAN000

ISSUE
A

DATE
11/19/2018

SUBARU OF AMERICA

PAGE
1/6

1 

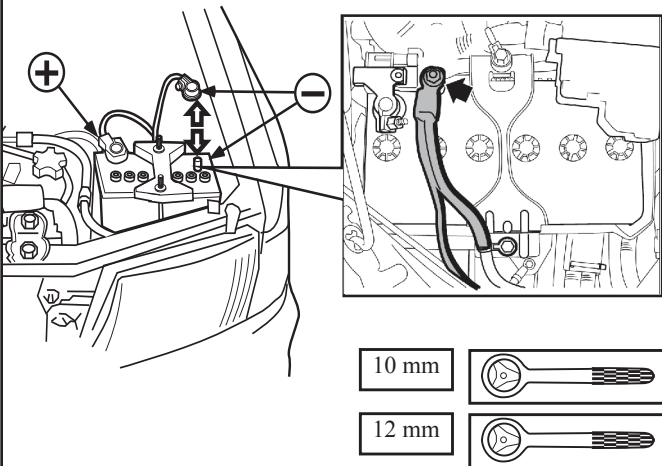

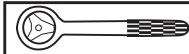

10 mm 

12 mm 

Disconnect battery. If equipped disconnect eyelet cable only.
Déconnectez la batterie. Si elle en est équipée, déconnectez le câble de l'œillet uniquement.

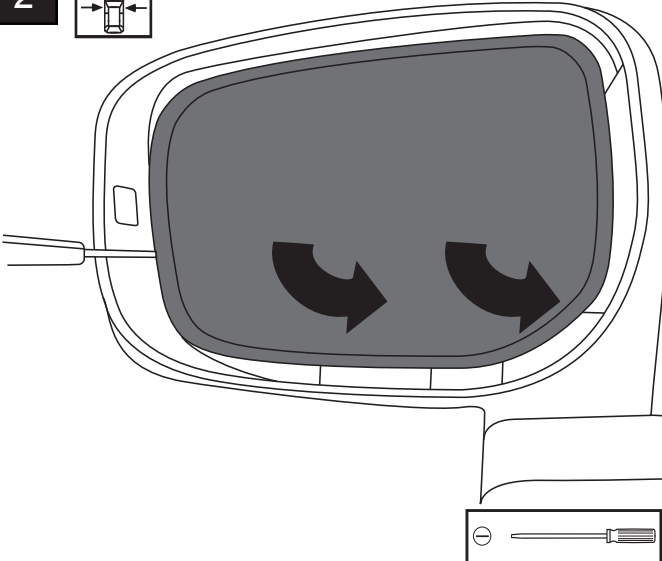
2 





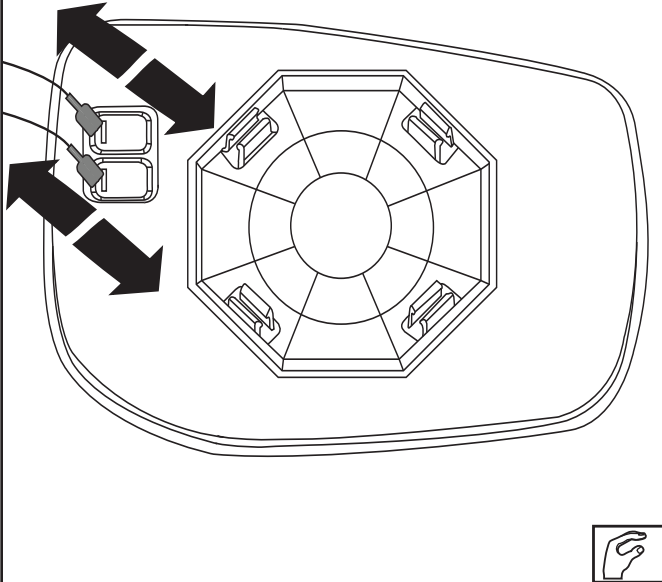

Protect mirror housing to prevent damage. Using screwdriver, remove mirror by disengaging the four mirror clips. Pull straight out to remove. Driver's side shown.
Protéger le boîtier de rétroviseur pour éviter de l'endommager. À l'aide d'un tournevis, retirer le rétroviseur en dégageant les quatre attaches. Tirer dessus directement pour le retirer. Côté du conducteur montré.

3 





If equipped, disconnect heater terminals.
Débranchez les bornes de chauffage, si le véhicule en est équipé.

4 

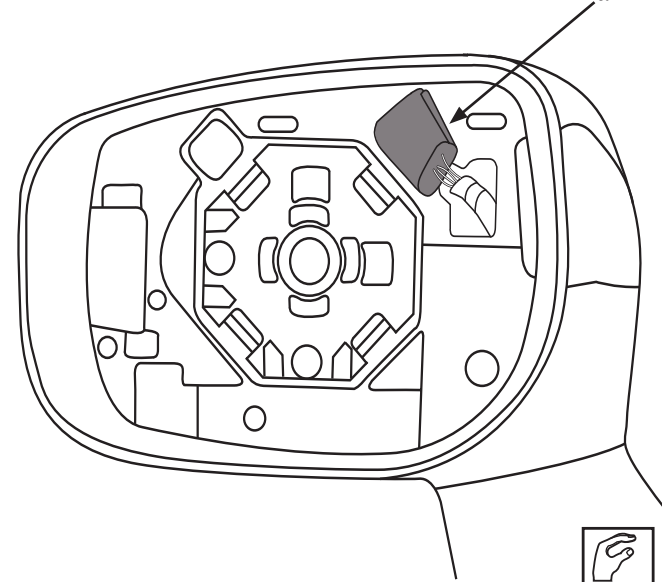



Locate and remove prearranged vehicle connector. (a)
⚠ WARNING - Do not pull harness wire to retrieve connector.
 Repérez le connecteur prémonté du véhicule et déposez-le.
 (a) **⚠ ATTENTION** : Ne tirez pas sur le fil du faisceau pour le récupérer.

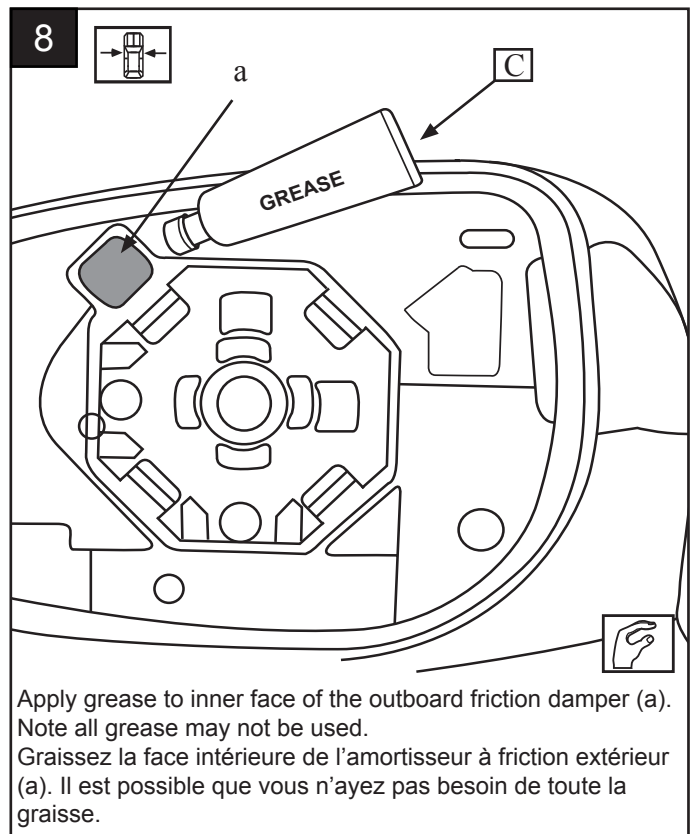
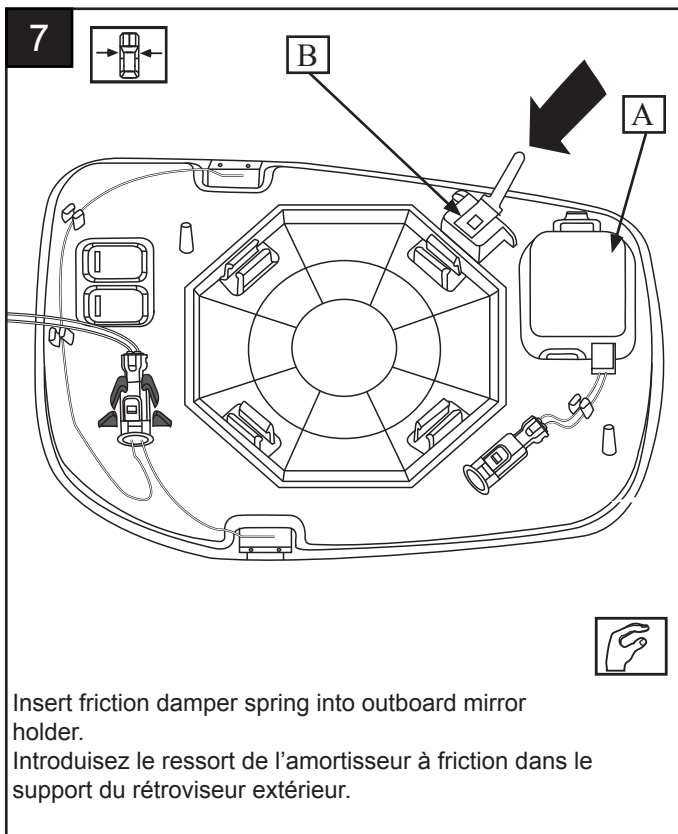
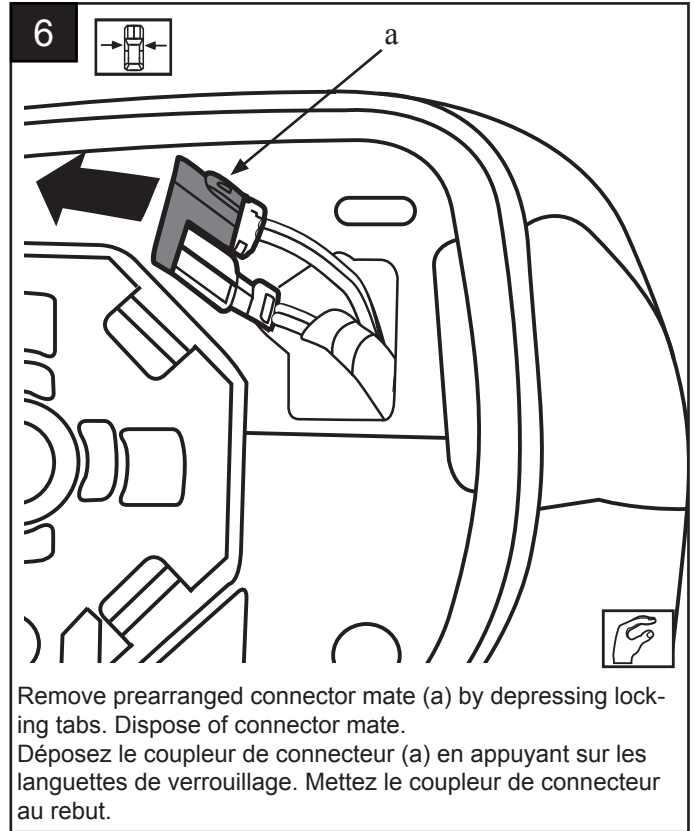
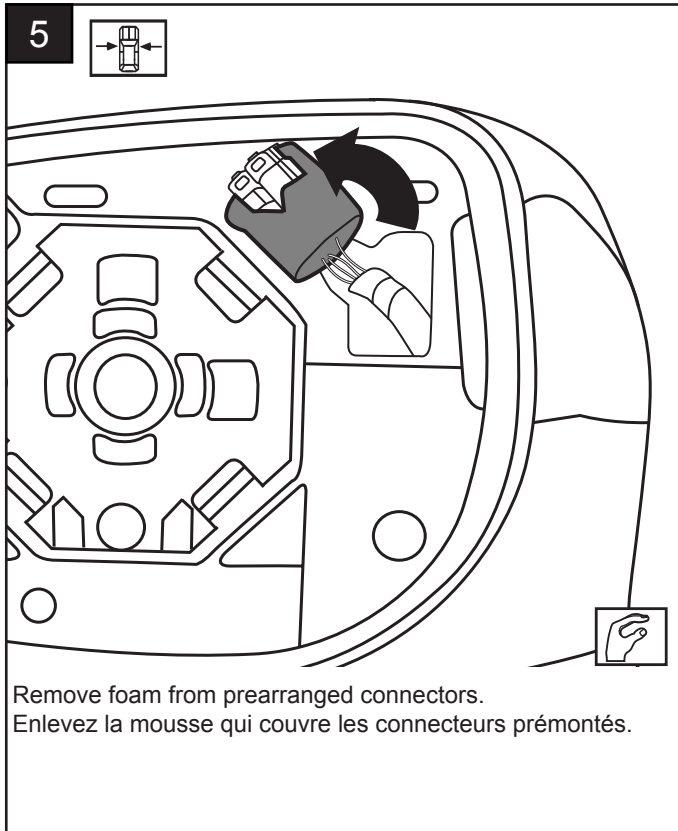

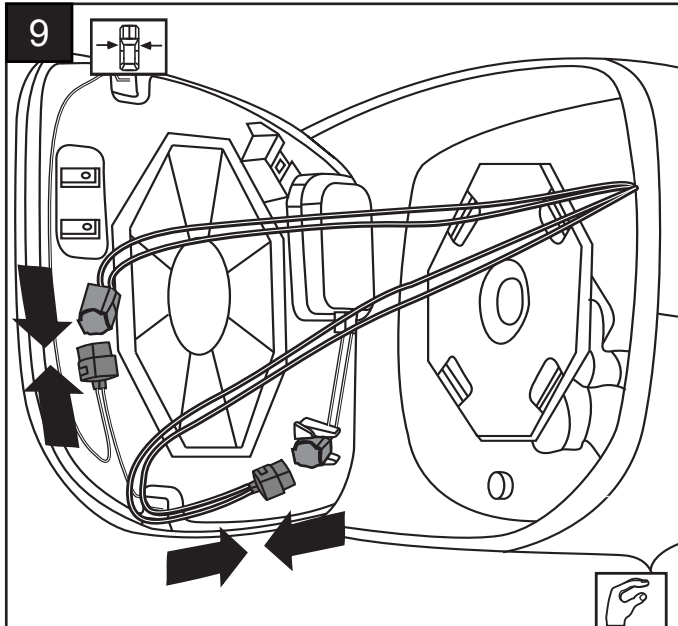

9

Plug prearranged vehicle connector's into mirror connector's. (i.e. black connector to black connector and white connector to white connector) Do not mix connectors of different colors. Branchez le connecteur prémonté du véhicule sur le connecteur du rétroviseur, c.-à-d. le connecteur noir sur le connecteur noir, et le connecteur blanc sur le connecteur blanc; ne mélangez pas la couleur des connecteurs.

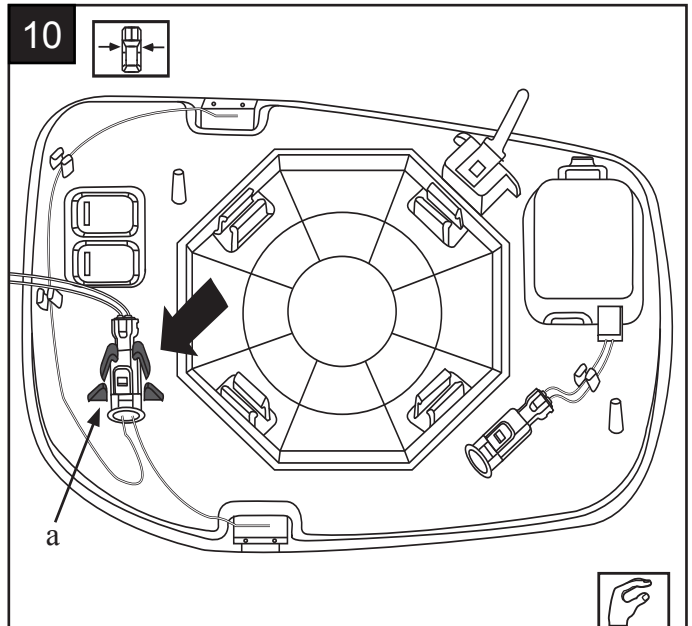

10

Secure connector pair (a) to mirror clip. Fixez la paire de connecteurs (a) à l'attache du rétroviseur.

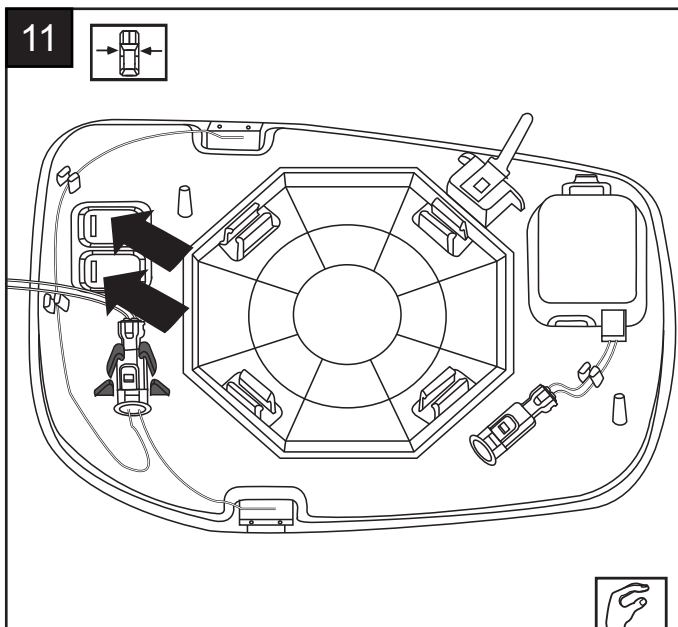

11

If equipped, connect heater terminals. Branchez les bornes de chauffage, si le véhicule en est équipé.

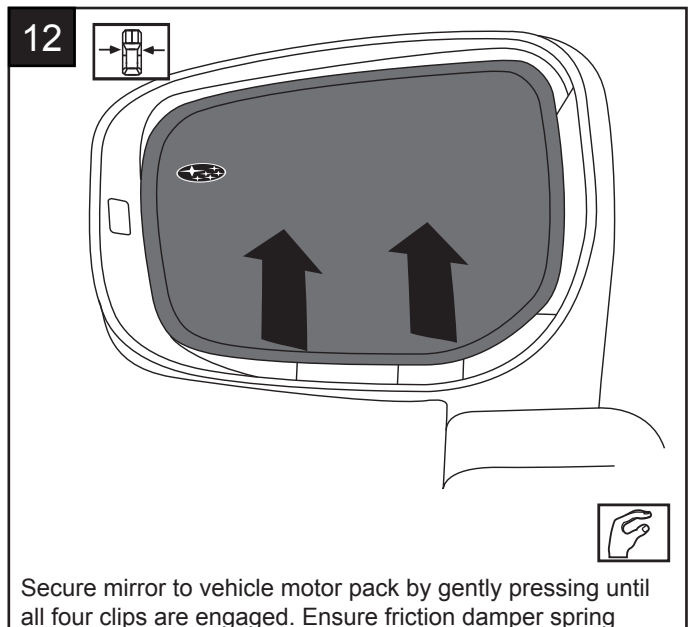

12

Secure mirror to vehicle motor pack by gently pressing until all four clips are engaged. Ensure friction damper spring inserts correctly into the housing damper pocket. Repeat for passenger's side. Fixer le rétroviseur au bloc-moteur du véhicule en appuyant doucement dessus jusqu'à ce que les quatre attaches s'enclenchent. Veiller à ce que le ressort amortisseur à friction soit inséré correctement dans le logement de l'amortisseur du boîtier. Répéter la procédure du côté passager.

13

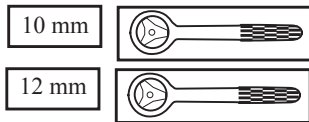
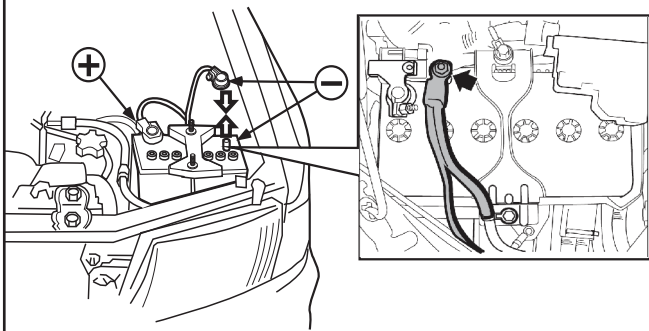

Reconnect battery. If equipped reconnect eyelet cable. Tighten bolt to 66 in-lbs.

Rebranchez la batterie. Si elle en est équipée, rebranchez le câble de l'œillet. Serrez les boulons à 66 lb-po.

PART NUMBER
J201SAN000

ISSUE
A

DATE
11/19/2018

SUBARU OF AMERICA

PAGE
5/6

14

Rear facing sensor
Capteur tourné vers l'arrière.

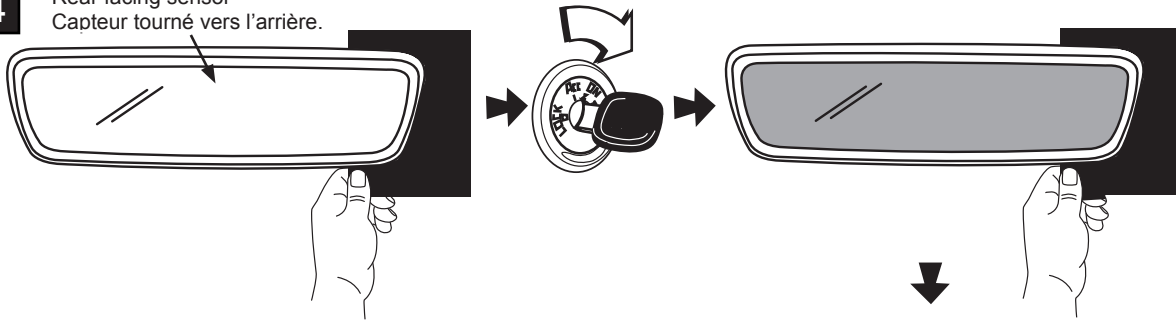

To test the dimming function, cover the forward facing sensor and shine light on the interior mirrors rear facing sensor.

Pour vérifier la fonction d'assombrissement, couvrir le capteur tourné vers l'avant et éclairer le capteur tourné vers l'arrière des rétroviseurs intérieurs.

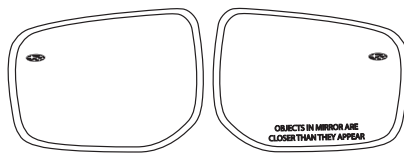
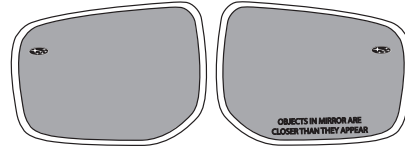

15

