



**SUBARU**

INSTALLATION INSTRUCTIONS

PART NUMBER: J121SE1000

DESCRIPTION:

Exterior Graphics - Side

**KIT CONTENTS:**

- 1. Exterior Graphics - Side (4).
- 2. Squeegee (1).
- 3. Alcohol Wipes (2).

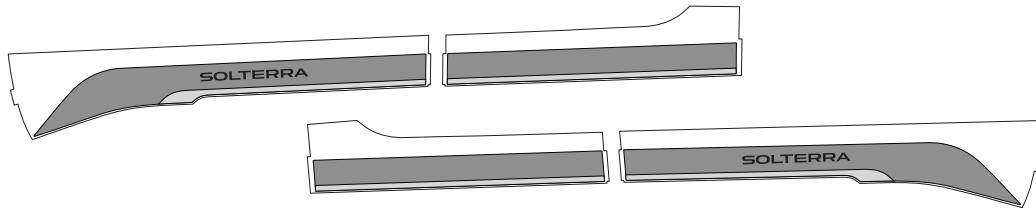

1. Exterior Graphics - LH Side + RH Side

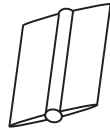

2. Squeegee (1)



3. Alcohol Wipes (2).

**TOOLS REQUIRED:**



Soft lint-free  
Microfiber Cloth



32 ounce  
Spray Bottle

- Water
- 2ml Baby Shampoo

**MEANING OF CHARACTERS:**



Denotes warnings that may lead to serious physical injury or vehicle damage.



Denotes quality processes to be checked prior to moving to the next step.

Denotes safety equipment required to be used such as a mask, goggles, rubber gloves, and hearing protection.



Denotes cautions to be taken to avoid physical injury or electronic component damage.



Denotes specific tools that are necessary to complete the step.



Mask



Goggles



Denotes cautions to be taken to avoid vehicle and component damage.



Denotes instructional steps necessary to complete the process.



Rubber Gloves



Hearing Protection

**PREPARATION - BEFORE INSTALLATION:**

1. This product should be installed with proper installation tools.
2. Install this product while observing all warnings and precautions stated in this instruction booklet.
3. **VERY IMPORTANT: Thoroughly wash vehicle with Soap and Water.**
4. Parts storage should be flat at room temperature and in a clean dry place. **Care should be taken to avoid a dusty environment.**

**Notes to the Installer**

1. Read the entire installation instructions prior to beginning the installation of the accessory.
2. Ensure that the vehicle is properly protected in the area that the accessory is to be installed.
3. To prevent vehicle damage, never place tools on top of painted surfaces, seats, dash pad, console or floor carpet / mat.
4. Always wear appropriate safety gear to include gloves and eye protection when required.

**Exterior Graphics - Side**

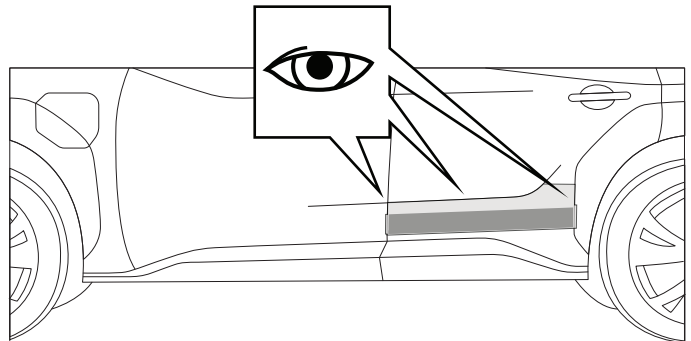
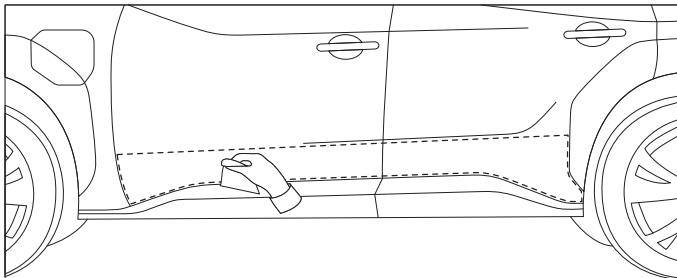

**1 | Alcohol**

Thoroughly wash vehicle with a soft lint-free cloth. Wipe the panel where the Exterior Graphic will be installed with alcohol wipes. Allow the area to dry completely.

**2 | Dry Fit**

Align the Exterior Graphic into position using the handling tabs and character lines.

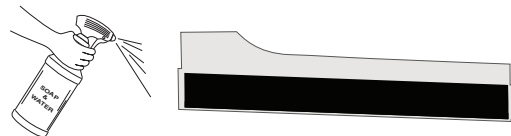
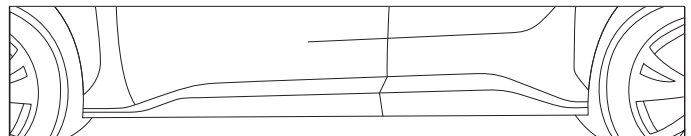
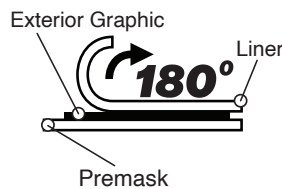
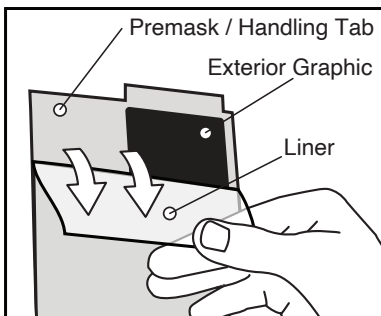

**3 | Separate Liner**

Remove liner from Exterior Graphic as shown. To prevent contamination, limit touching adhesive side of the Exterior Graphic by using handling tabs.

**4 | Spray Vehicle / Adhesive of Exterior Graphic**

Spray the adhesive side of the Exterior Graphic with the soap and water solution. Then spray the vehicle surface where the Exterior Graphic will be installed.

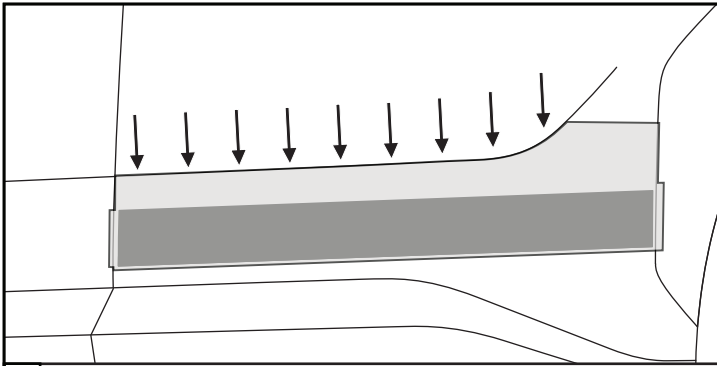

**5 Exterior Graphic Placement**

 While using the handling tabs align the top of the Exterior Graphic to the top character line.

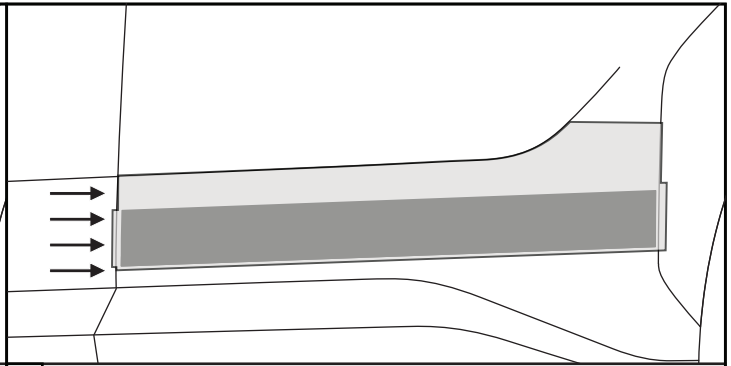

**6 Exterior Graphic Placement**

 While using the handling tabs, then align the left side of the Exterior Graphic to the door panel edge.

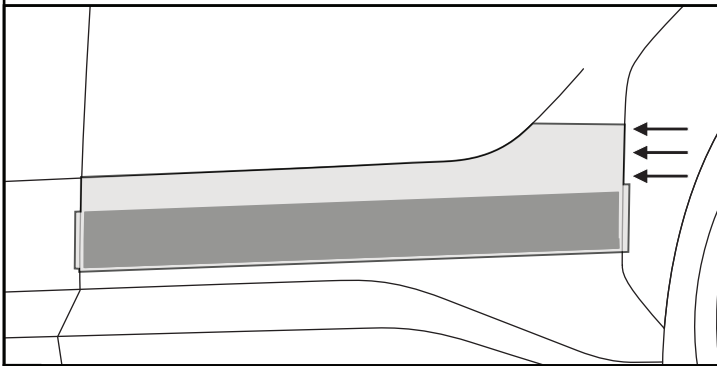

**7 Exterior Graphic Placement**

 While using the handling tabs, lastly align the right side of the Exterior Graphic to the door panel edge.

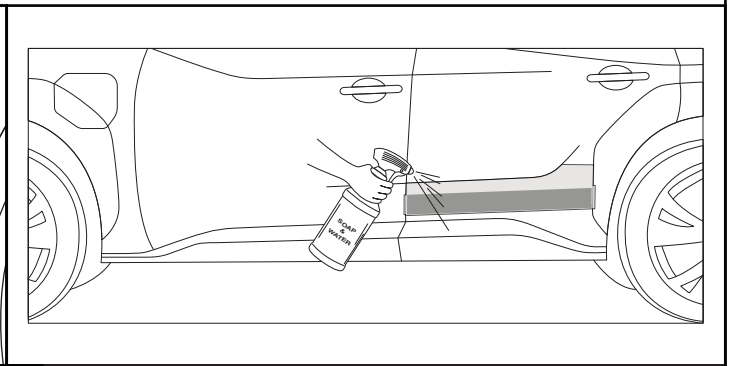

**8 Spray Exterior Graphic Premask**

 Spray the top surface of the premask with the soap and water solution. This makes it possible for the squeegee to slide easily across the surface.

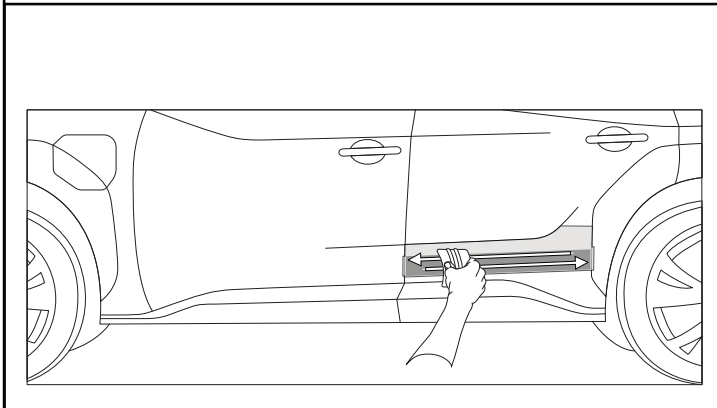

**9 Squeegee Exterior Graphic**

 Use caution not to scratch the paint surface with the squeegee.  
Using smooth even overlapping strokes squeegee the Exterior Graphic into position.

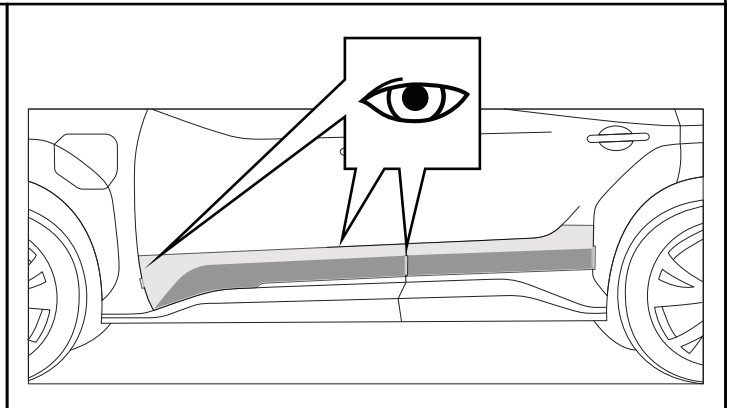

**10 Dry Fit**

 Align the Exterior Graphic into position using the handling tabs, door notches and top character line.

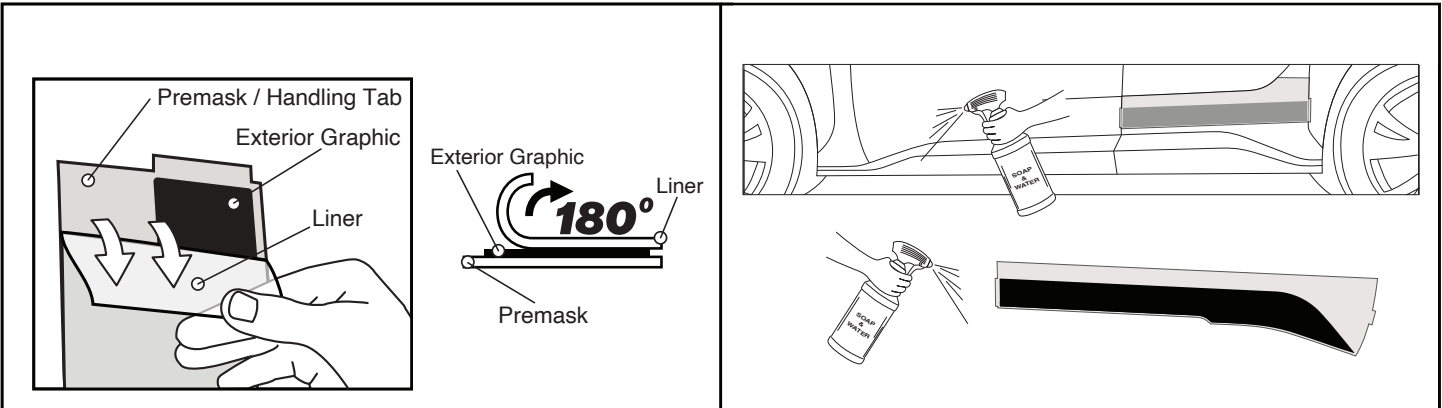

**11 Separate Liner**

 Remove liner from Exterior Graphic as shown. To prevent contamination, limit touching adhesive side of the Exterior Graphic by using handling tabs.

**12 Spray Vehicle / Adhesive of Exterior Graphic**

 Spray the adhesive side of the Exterior Graphic with the soap and water solution. Then spray the vehicle surface where the Exterior Graphic will be installed.

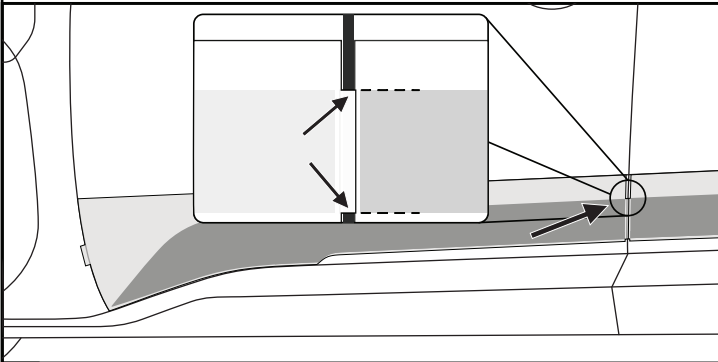

**13 Exterior Graphic Placement**

 While using the handling tabs align the right of the Exterior Graphic to the door panel edge. Line the handling tab up so that it is in line with the already installed section.

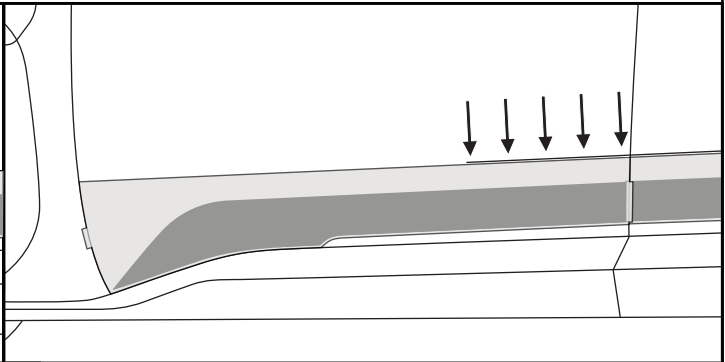

**14 Exterior Graphic Placement**

 While using the handling tabs align the top of the Exterior Graphic to the top character line.

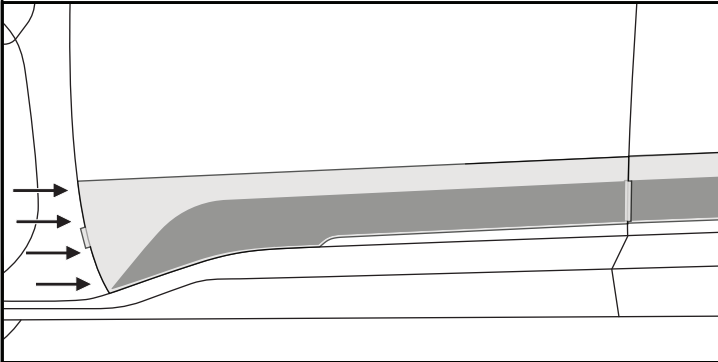

**15 Exterior Graphic Placement**

 While using the handling tabs align the left hand side of the Exterior Graphic to the door panel edge.

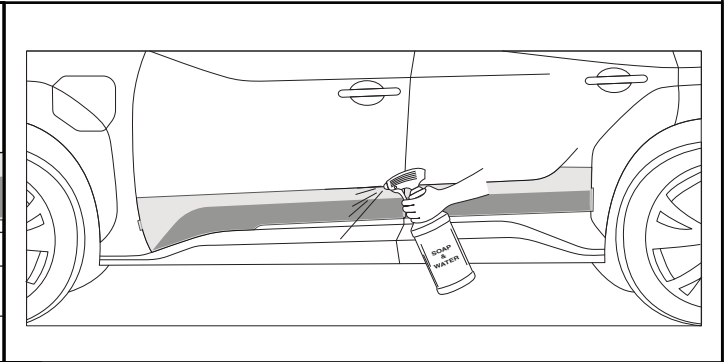

**16 Spray Exterior Graphic Premask**

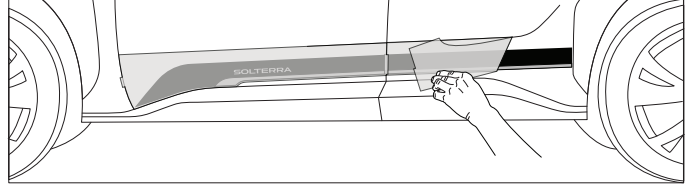
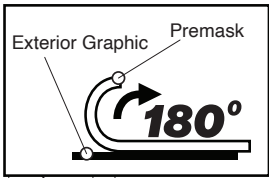
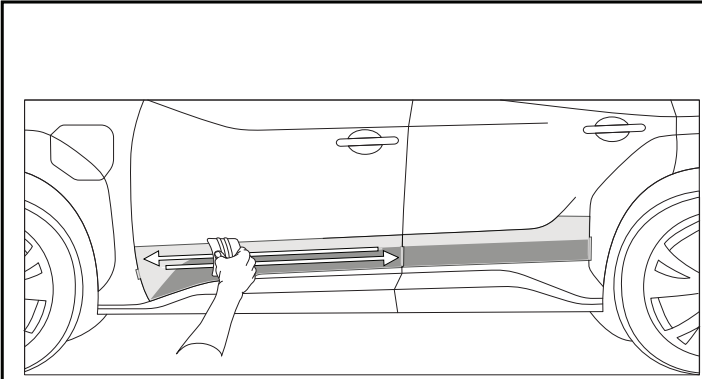

 Spray the top surface of the premask with the soap and water solution. This makes it possible for the squeegee to slide easily across the surface.



**17 Squeegee Exterior Graphic**

 Use caution not to scratch the paint surface with the squeegee. Using smooth even overlapping strokes squeegee the Exterior Graphic into position.

**18 Remove Premask**

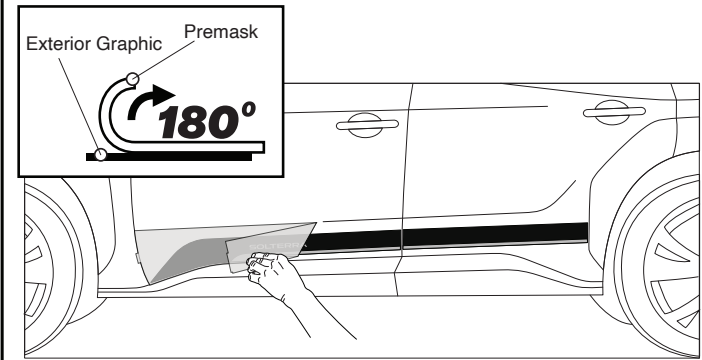

 Carefully remove the premask from the Exterior Graphic by slowly lifting and pulling backward at an 180° angle as shown. 



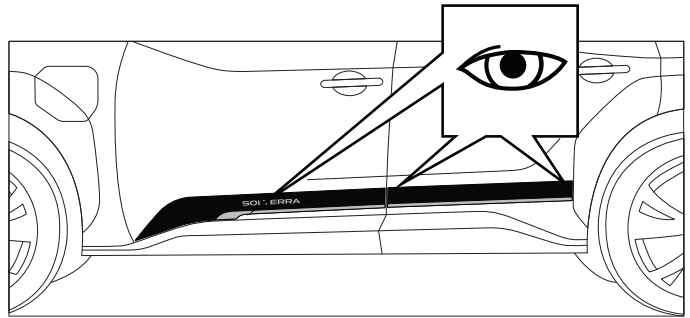

***\*(Repeat Steps 1-20 for the opposite side of vehicle.)***



**19 Remove Premask**

 Carefully remove the premask from the Exterior Graphic by slowly lifting and pulling backward at an 180° angle as shown. 

**20 Inspect Exterior Graphic**

 If bubbles are present after premask carrier removal, wrap a towel around the squeegee and carefully attempt to push the bubble to the side of the Exterior Graphic. If the bubble cannot be moved, use a sewing needle to pierce the bubble and press the remaining solution from beneath the Exterior Graphic. 

## Care and Cleaning

Items to be Checked	Results of the Check
	After an Exterior Graphic installation has been completed, do not high pressure wash the vehicle for 72 hours.

## Visual Check

Items to be Checked	Results of the Check
	Make sure all edges are firmly adhered.



**SUBARU**

INSTRUCTIONS D'INSTALLATION

NUMÉRO DE PIÈCE : J121SE1000

DESCRIPTION:

Éléments graphiques extérieurs – côté

CONTENU DE LA TROUSSE :

1. Éléments graphiques extérieurs – côté (4)

3. Lingettes imbibées d'alcool (2)

2. Racloir (1)

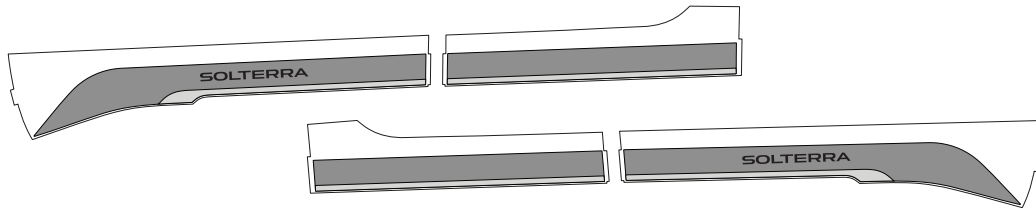

1. Éléments graphiques extérieurs – côté gauche et côté droit

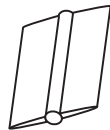

2. Racloir (1)



3. Lingettes imbibées d'alcool (2)

OUTILS REQUIS:



Linge en microfibre doux et non pelucheux



Flacon pulvérisateur de 946 ml (32 oz)

• Eau

• 2 ml de shampooing pour bébé

SIGNIFICATION DES SYMBOLES:



Indique les avertissements de possibilité de blessure grave ou de dommages au véhicule.



Indique les vérifications de qualité à effectuer avant de passer à la prochaine étape.

Indique l'équipement de sécurité requis et devant être utilisé, comme un masque, des lunettes de sécurité, des gants en caoutchouc et des dispositifs de protection antibruit.



Indique les précautions à prendre pour éviter les blessures ou les dommages aux composants électroniques.



Indique les outils nécessaires pour compléter une étape.



Masque



Lunettes de sécurité



Indique les précautions à prendre pour éviter les dommages au véhicule et aux composants.



Indique la marche à suivre pour compléter le processus.



Gants en caoutchouc



Dispositif de protection antibruit

**PRÉPARATION – AVANT L'INSTALLATION:**

1. Ce produit doit être installé avec les outils d'installation adéquats.
2. Installez ce produit tout en respectant toutes les mises en garde et précautions signalées dans ce livret d'instructions.
3. **TRÈS IMPORTANT : Bien laver le véhicule avec du savon et de l'eau.**
4. Les pièces doivent être entreposées à plat et à température ambiante dans un endroit propre et sec. **Il faut veiller à éviter tout environnement poussiéreux.**

**Remarques à l'intention de l'installateur**

1. Lisez l'ensemble des instructions d'installation avant de commencer l'installation de l'accessoire.
2. Assurez-vous que la zone du véhicule est bien protégée là où l'accessoire doit être installé.
3. Pour éviter tout dommage au véhicule, ne jamais poser d'outils sur les surfaces peintes, les sièges, le dessus du tableau de bord, la console ou les tapis de sol.
4. Portez toujours les équipements de protection appropriés, y compris des gants et des lunettes de protection pour les yeux au besoin.

**Éléments graphiques extérieurs – côté**

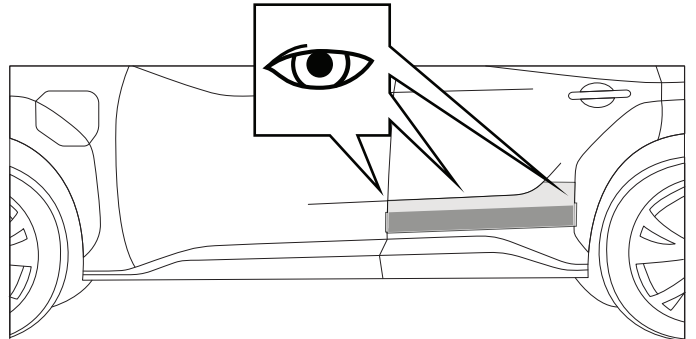
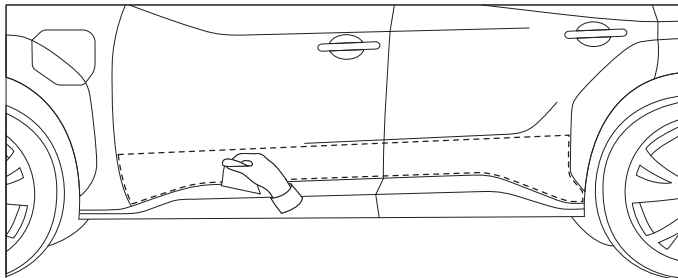

**1 | Alcool**

 Laver le véhicule soigneusement avec un linge doux et non pelucheux. Essuyer le panneau à l'endroit où le graphique extérieur sera posé à l'aide de lingettes imbibées d'alcool. Laisser la surface sécher complètement.

**2 | Ajustement à sec**

 Aligner le graphique extérieur en utilisant les languettes de manipulation et les lignes en relief.

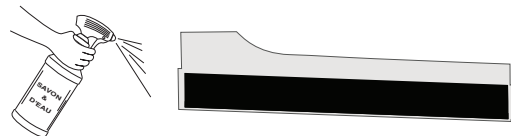
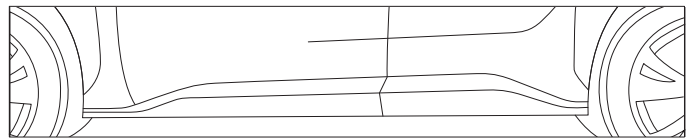
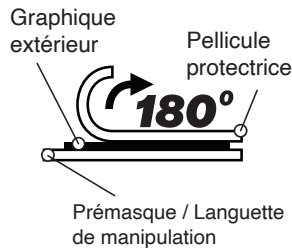
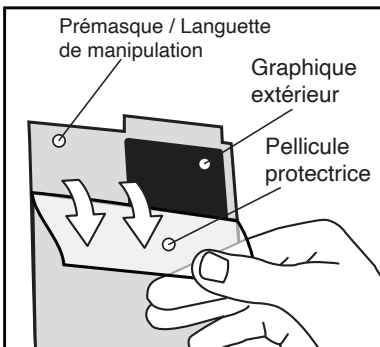

**3 | Retirer la pellicule protectrice**

 Retirer la pellicule protectrice du graphique extérieur, comme illustré. Pour éviter toute contamination, limiter les contacts avec le côté adhésif du graphique extérieur en utilisant les languettes de manipulation.

**4 | Vaporiser le véhicule/l'élément adhésif du graphique extérieur**

 Vaporiser l'élément adhésif du graphique extérieur avec la solution d'eau savonneuse. Vaporiser ensuite la surface du véhicule à l'endroit où le graphique extérieur sera posé.



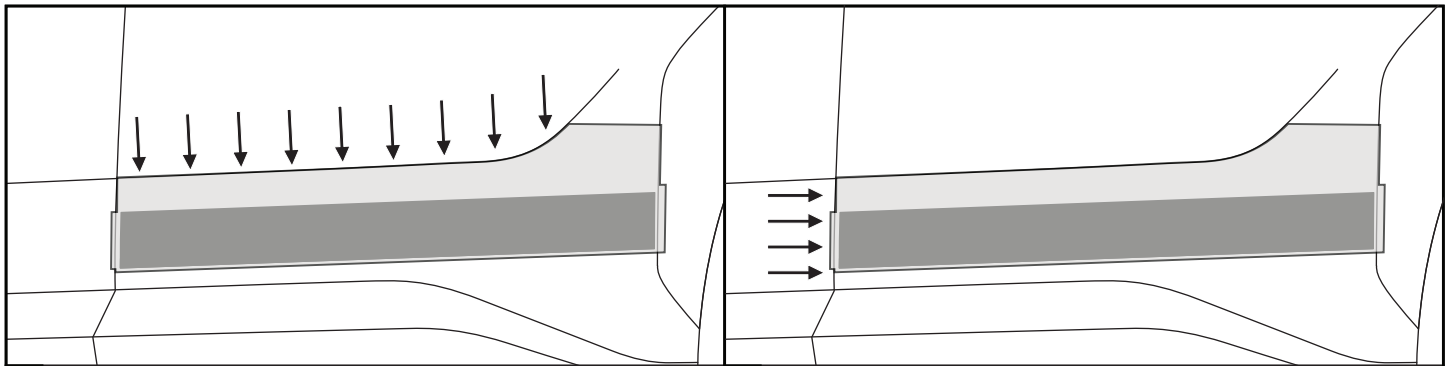

**5 Position du graphique extérieur**

 Aligner le haut du graphique extérieur avec la ligne en relief supérieure en utilisant les languettes de manipulation.

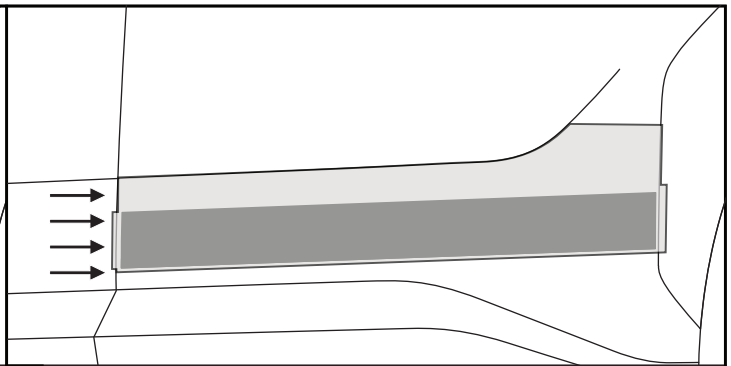

**6 Position du graphique extérieur**

 Aligner le côté gauche du graphique extérieur au bord du panneau de porte en utilisant les languettes de manipulation.

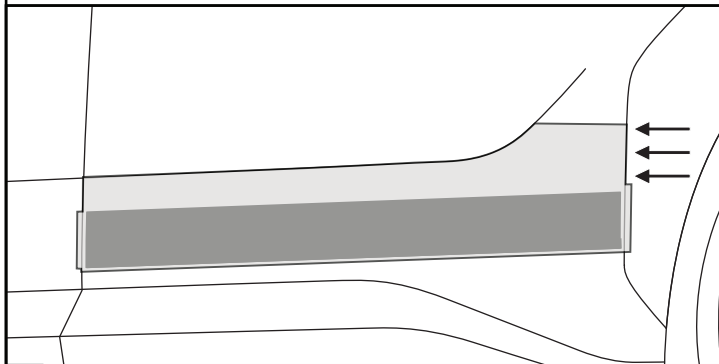

**7 Position du graphique extérieur**

 Aligner le côté droit du graphique extérieur au bord du panneau de porte en utilisant les languettes de manipulation.

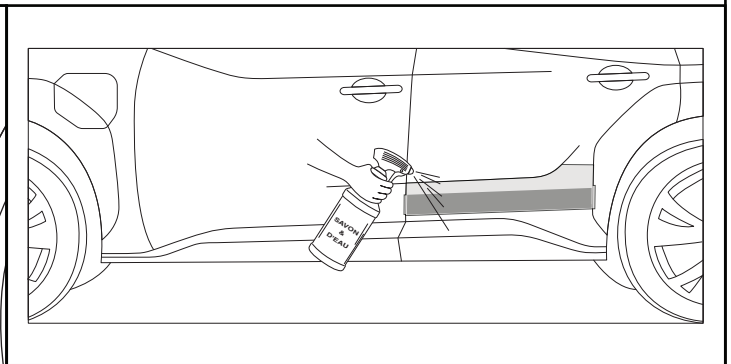

**8 Vaporiser le prémasque du graphique extérieur**

 Vaporiser la surface supérieure du prémasque avec la solution d'eau savonneuse. Cela permet au racloir de glisser facilement sur la surface.

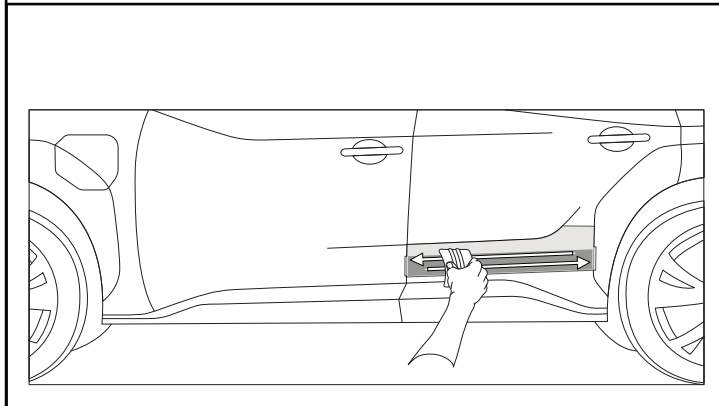

**9 Racler le graphique extérieur**

 **Faire attention pour ne pas rayer la surface peinte avec le racloir.**  
Racler le graphique extérieur à l'aide de mouvements légers et de chevauchement uniforme jusqu'à ce qu'il soit en place.

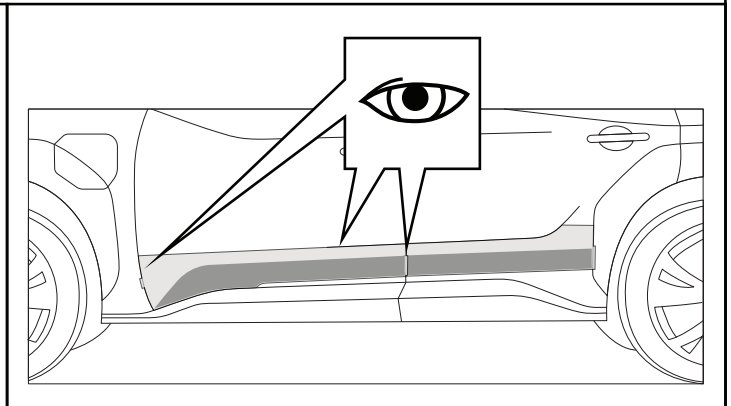

**10 Ajustement à sec**

 Aligner le graphique extérieur en utilisant les languettes de manipulation, les encoches de porte et la ligne en relief comme points de repère.

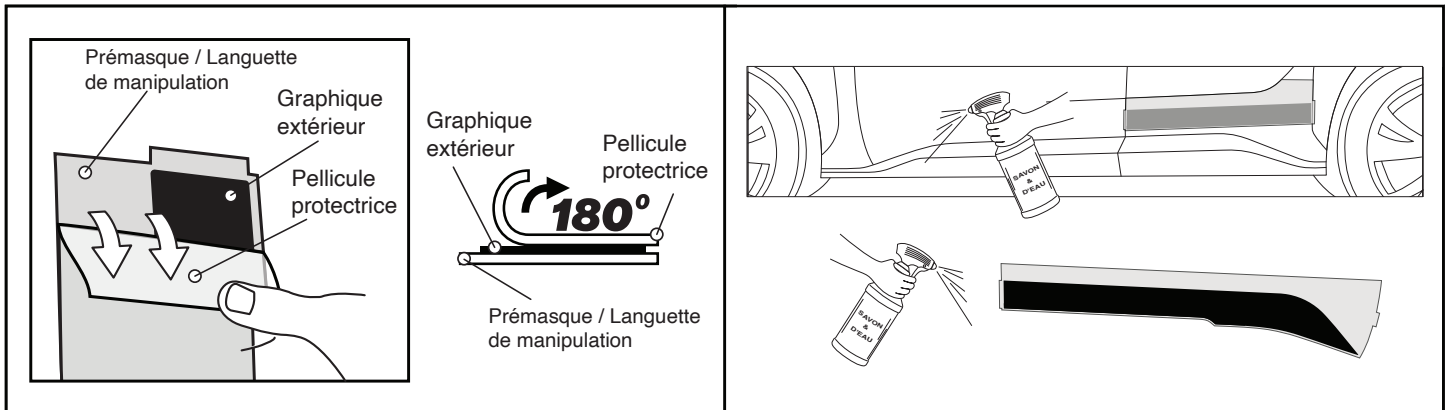

**11 Retirer la pellicule protectrice** **12 Vaporiser le véhicule/l'élément adhésif du graphique extérieur**

 Retirer la pellicule protectrice du graphique extérieur, comme illustré. Pour éviter toute contamination, limiter les contacts avec le côté adhésif du graphique extérieur en utilisant les languettes de manipulation.

 Vaporiser l'élément adhésif du graphique extérieur avec la solution d'eau savonneuse. Vaporiser ensuite la surface du véhicule à l'endroit où le graphique extérieur sera posé.

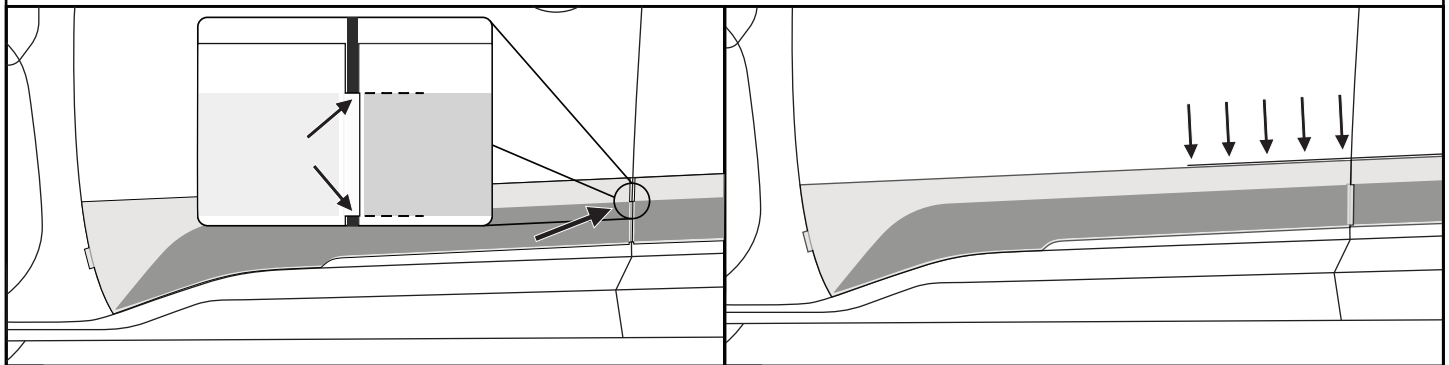

**13 Position du graphique extérieur** **14 Position du graphique extérieur**

 Aligner le côté droit du graphique extérieur au bord du panneau de porte en utilisant les languettes de manipulation. Aligner la languette de manipulation en haut pour qu'elle corresponde à la section déjà installée.

 Aligner le haut du graphique extérieur avec la ligne en relief supérieure en utilisant les onglets de manipulation.

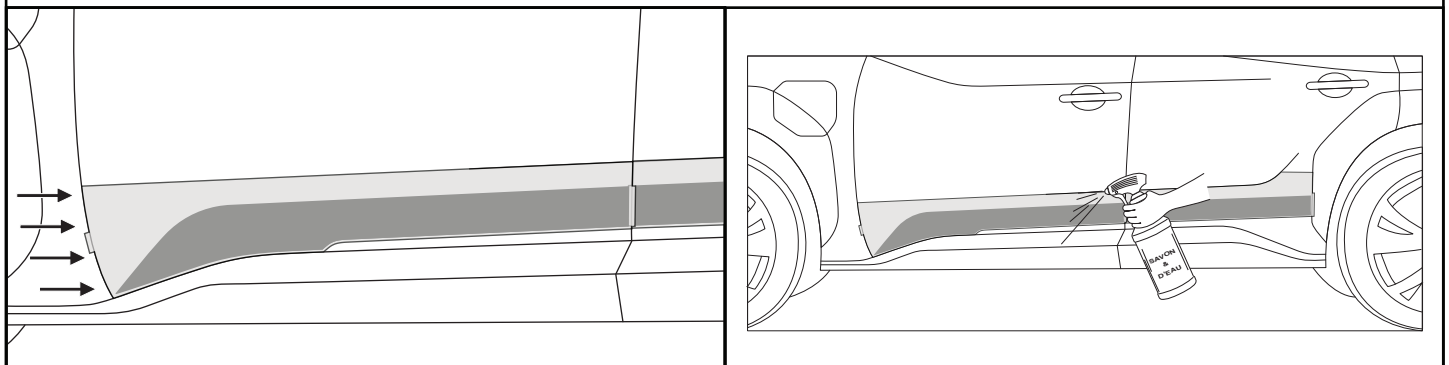

**15 Position du graphique extérieur** **16 Vaporiser le prémasque du graphique extérieur**

 Aligner le côté gauche du graphique extérieur avec le bord du panneau de porte en utilisant les languettes de manipulation.

 Vaporiser la surface supérieure du prémasque avec la solution d'eau savonneuse. Cela permet au racloir de glisser facilement sur la surface.

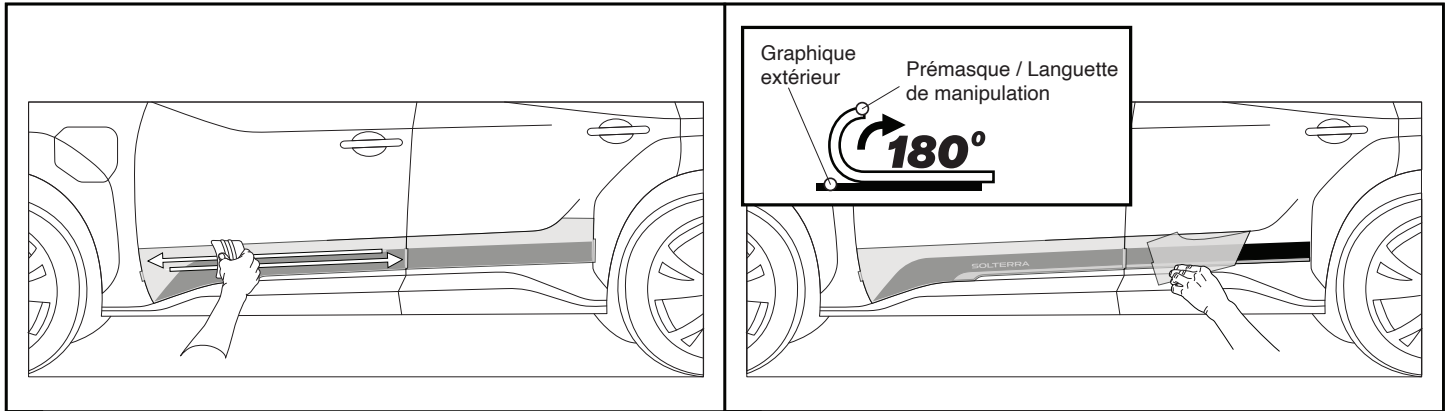

**17 Racler le graphique extérieur**

**Faire attention pour ne pas rayer la surface peinte avec le racloir.**  
 Racler le graphique extérieur à l'aide de mouvements légers et de chevauchement uniforme jusqu'à ce qu'il soit en place.

**18 Retirer le prémasque**

Retirer délicatement le prémasque du graphique extérieur en le soulevant lentement puis en le tirant vers l'arrière à un angle de 180°, comme illustré.

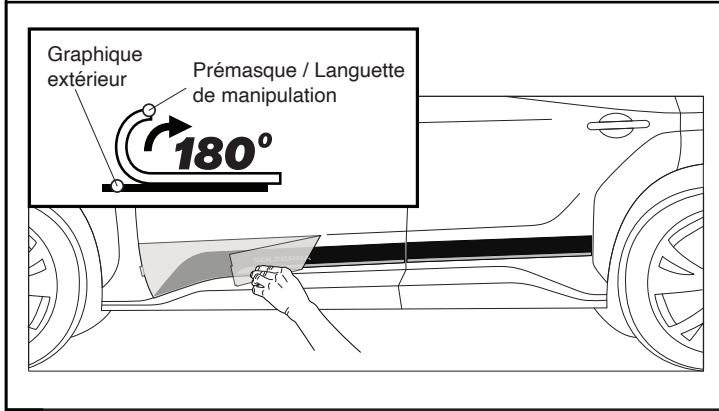

**19 Retirer le prémasque**

Retirer délicatement le prémasque du graphique extérieur en le soulevant lentement puis en le tirant vers l'arrière à un angle de 180°, comme illustré.

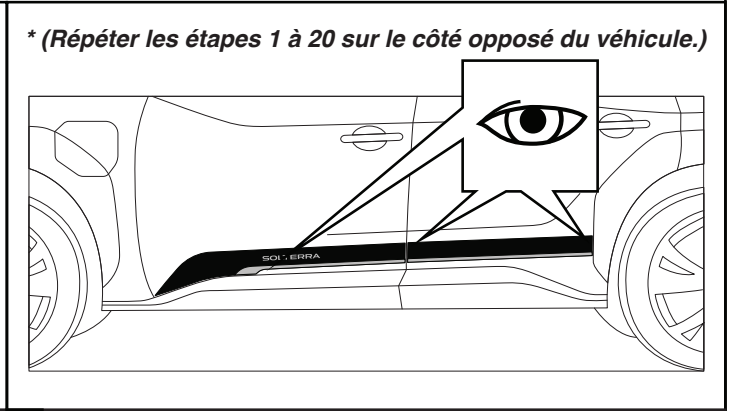

**20 Inspecter le graphique extérieur**

Si des bulles sont présentes après le retrait du prémasque, envelopper le racloir d'une serviette et tenter attentivement de pousser la bulle vers le côté de l'autocollant. S'il est impossible de déplacer la bulle, utiliser une aiguille à coudre pour percer la bulle et extraire la solution restante qui se trouve sous le graphique extérieur.

## Nettoyage Et Entretien

Éléments à vérifier		Résultats de la vérification
	Une fois l'installation d'un graphique extérieur terminée, ne pas laver le véhicule à haute pression pendant 72 heures.	

## Vérification Visuelle

Éléments à vérifier		Résultats de la vérification
	Vérifier que tous les bords sont bien collés.	