



SUBARU

INSTALLATION INSTRUCTIONS

PART NUMBER: J121SCA000

DESCRIPTION:

BRZ Exterior Graphics, Side

KIT CONTENTS:

- 1. Front Bodyside Decal (2).
- 2. Squeegee (1).
- 3. Alcohol Wipes (2).

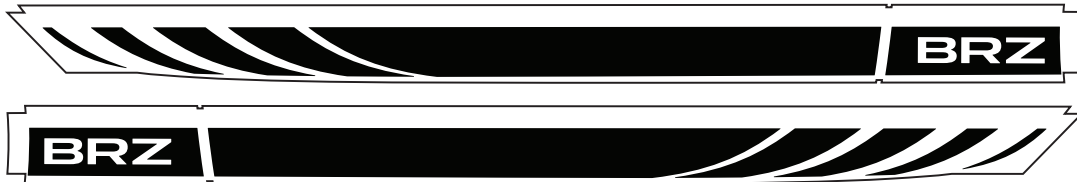

1. Front Bodyside Decal RH / LH (2)

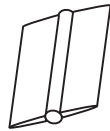

2. Squeegee (1)



3. Alcohol Wipes (2)

TOOLS REQUIRED:



Soft lint-free
Microfiber Cloth



Spray Bottle

1.0 ml Baby Shampoo
(4-5 Small Drops)
for every
16 oz Water

MEANING OF CHARACTERS:



Denotes warnings that may lead to serious physical injury or vehicle damage.



Denotes quality processes to be checked prior to moving to the next step.

Denotes safety equipment required to be used such as a mask, goggles, rubber gloves, and hearing protection.



Denotes cautions to be taken to avoid physical injury or electronic component damage.



Denotes specific tools that are necessary to complete the step.



Mask



Goggles



Denotes cautions to be taken to avoid vehicle and component damage.



Denotes instructional steps necessary to complete the process.



Rubber Gloves



Hearing Protection

PREPARATION - BEFORE INSTALLATION:

1. This product should be installed with proper installation tools.
2. Install this product while observing all warnings and precautions stated in this instruction booklet.
3. **VERY IMPORTANT: Thoroughly wash vehicle with Soap and Water.**
4. Parts storage should be flat at room temperature and in a clean dry place. **Care should be taken to avoid a dusty environment.**

Notes to the Installer

1. Read the entire installation instructions prior to beginning the installation of the accessory.
2. Ensure that the vehicle is properly protected in the area that the accessory is to be installed.
3. To prevent vehicle damage, never place tools on top of painted surfaces, seats, dash pad, console or floor carpet / mat.
4. Always wear appropriate safety gear to include gloves and eye protection when required.

Lower Bodyside Decal

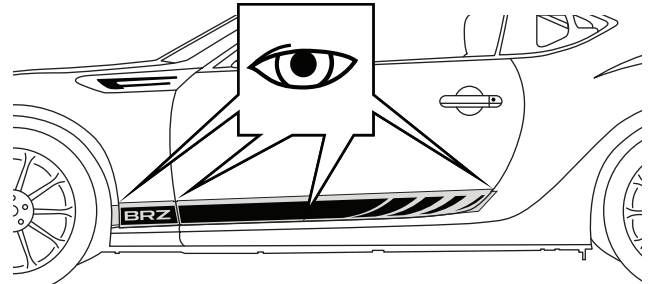
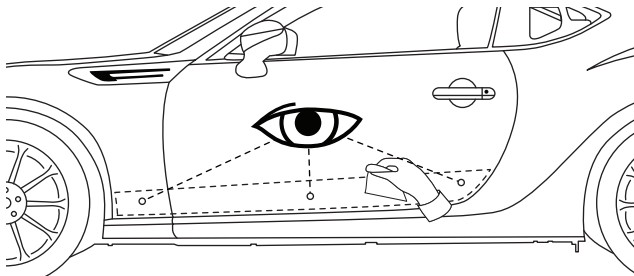

1 Alcohol

Thoroughly wash and clean vehicle surface with a soft lint-free cloth. Wipe the panel where the decal will be installed with alcohol wipes. Allow the area to dry completely.

2 Dry Fit

Align the decal into position using the handling tabs, door notches and panel edges as references.

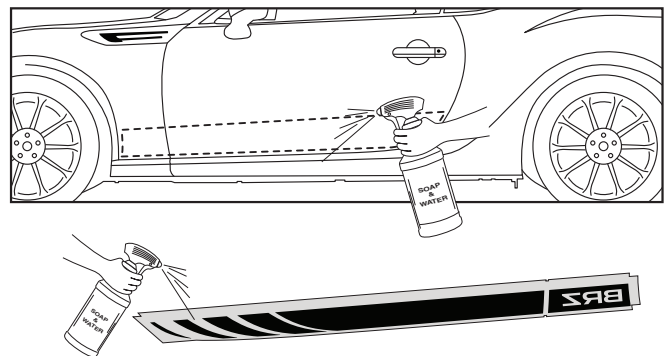
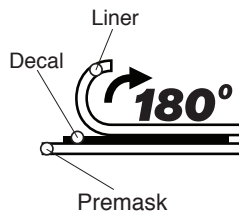
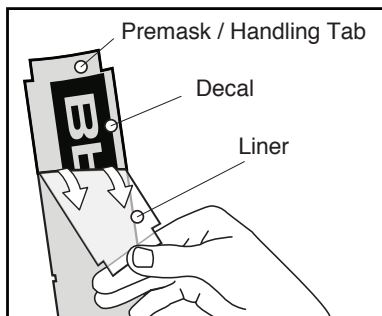

3 Separate Liner

Remove liner from decal as shown. To prevent contamination, limit touching adhesive side of the decal by using handling tabs.

4 Spray Vehicle / Adhesive of Decal

Spray and saturate the adhesive side of the decal with the soap and water solution. Then spray the vehicle surface where the decal will be installed.

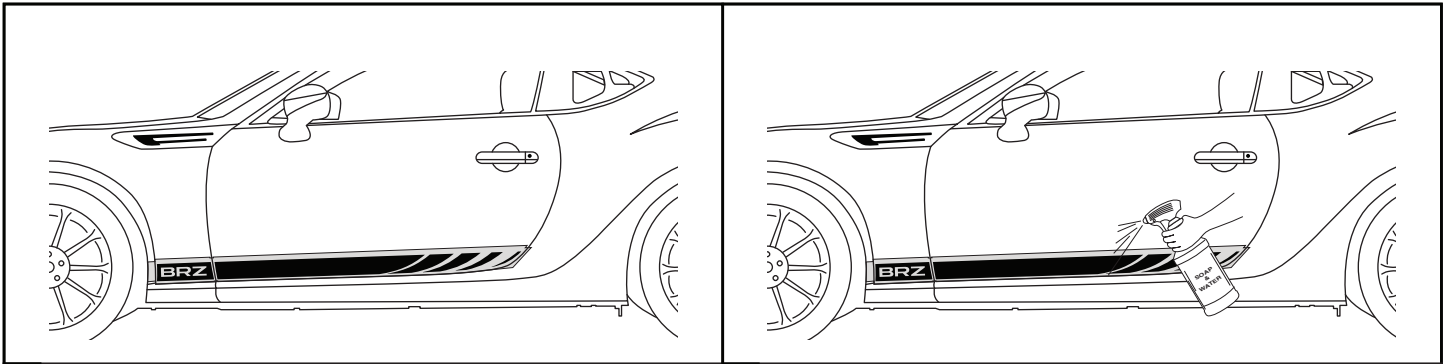

5 Decal Placement

While using the handling tabs align the decal into position. This allows the part to float on the surface until proper fit is achieved.

6 Spray Decal Premask

Spray the top surface of the premask with the soap and water solution. This makes it possible for the squeegee to slide easily across the surface.

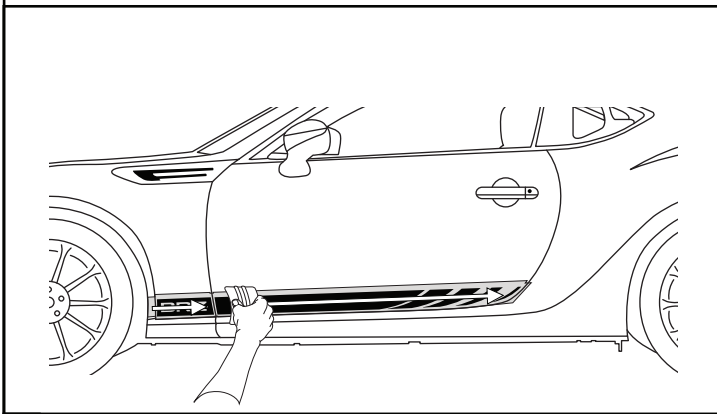

7 Squeegee Decal

Use caution not to scratch the paint surface with the squeegee. Using firm even pressure and overlapping strokes squeegee the decal into position.

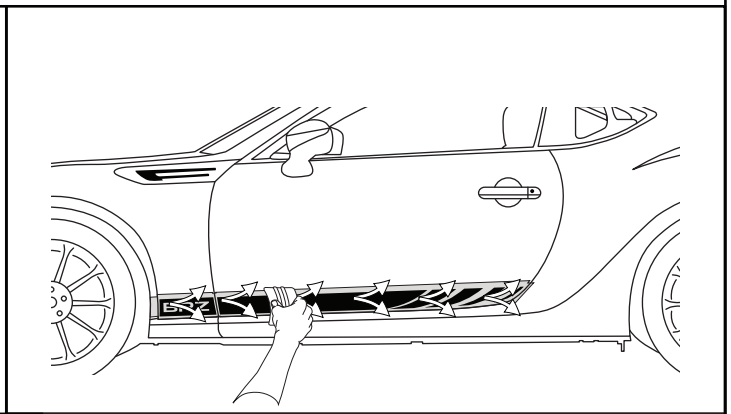

8 Squeegee Decal

Use caution not to scratch the paint surface with the squeegee. Working from the center out ensure each piece of the decal has been securely adhered to the vehicle surface.

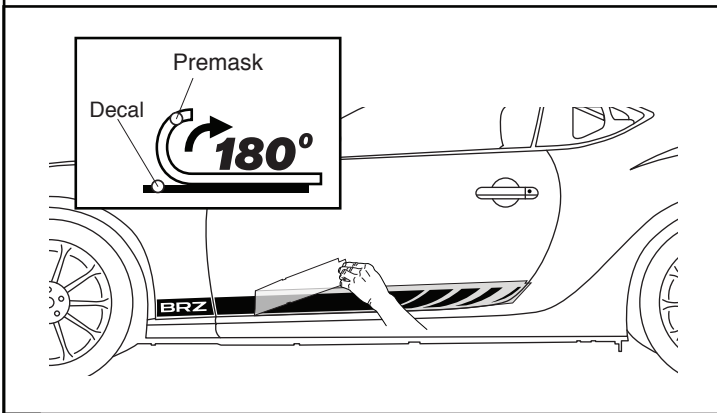

9 Remove Premask

SLOWLY AND CAREFULLY remove the premask from the decal by lifting and pulling backward at an 180° angle as shown. If decal lifts with premask, re-squeegee the area.

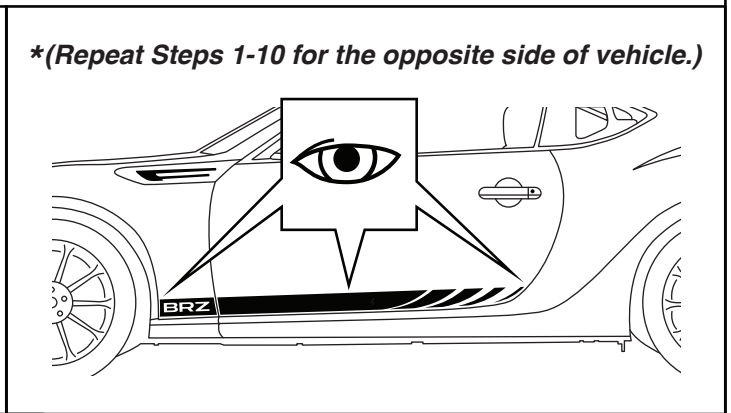

10 Inspect Decal

If bubbles are present after premask carrier removal, wrap a towel around the squeegee and carefully attempt to push the bubble to the side of the decal. If the bubble cannot be moved, use a sewing needle to pierce the bubble and press the remaining solution from beneath the decal.

Care and Cleaning

	Items to be Checked	Results of the Check
	After a decal installation has been completed, do not high pressure wash the vehicle for 72 hours.	

Visual Check

	Items to be Checked	Results of the Check
	Make sure all edges are firmly adhered.	



SUBARU

INSTRUCTIONS D'INSTALLATION

NUMÉRO DE PIÈCE: J121SCA000

DESCRIPTION:

Graphiques extérieurs BRZ, côté

CONTENU DE LA TROUSSE:

- 1. Autocollant de carrosserie avant (2).
- 2. Racloir (1).
- 3. Lingettes imbibées d'alcool (2).

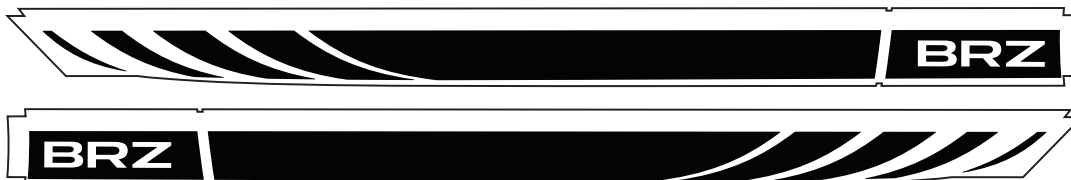

1. Autocollant de carrosserie avant RH / LH (2)

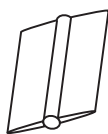

2. Racloir (1)



3. Lingettes imbibées d'alcool (2).

OUTILS REQUIS:



Linge non pelucheux doux



Pulvérisateur

1,0 ml de shampooing pour bébé (4-5 petites gouttes) pour 450 ml (16 oz) d'eau

SIGNIFICATION DES SYMBOLES:



Indique les avertissements de possibilité de blessure grave ou de dommages au véhicule.



Indique les vérifications de qualité à effectuer avant de passer à la prochaine étape.

Indique l'équipement de sécurité requis et devant être utilisé, comme un masque, des lunettes de sécurité, des gants en caoutchouc et des dispositifs de protection antibruit.



Indique les précautions à prendre pour éviter les blessures ou les dommages aux composants électroniques.



Indique les outils nécessaires pour compléter une étape.



Masque



Lunettes de sécurité



Indique les précautions à prendre pour éviter les dommages au véhicule et aux composants.



Indique la marche à suivre pour compléter le processus.



Gants en caoutchouc



Dispositif de protection antibruit

PRÉPARATION – AVANT L’INSTALLATION:

1. Ce produit doit être installé avec les outils d’installation adéquats.
2. Installez ce produit tout en respectant toutes les mises en garde et précautions signalées dans ce livret d’instructions.
3. **TRÈS IMPORTANT : Bien laver le véhicule avec du savon et de l’eau.**
4. Les pièces doivent être entreposées à plat et à température ambiante dans un endroit propre et sec. **Il faut veiller à éviter tout environnement poussiéreux.**

Remarques à l’intention de l’installateur

1. Lisez l’ensemble des instructions d’installation avant de commencer l’installation de l’accessoire.
2. Assurez-vous que la zone du véhicule est bien protégée là où l’accessoire doit être installé.
3. Pour éviter tout dommage au véhicule, ne jamais poser d’outils sur les surfaces peintes, les sièges, le dessus du tableau de bord, la console ou les tapis de sol.
4. Portez toujours les équipements de protection appropriés, y compris des gants et des lunettes de protection pour les yeux au besoin.

Autocollant pour la partie inférieure de la carrosserie

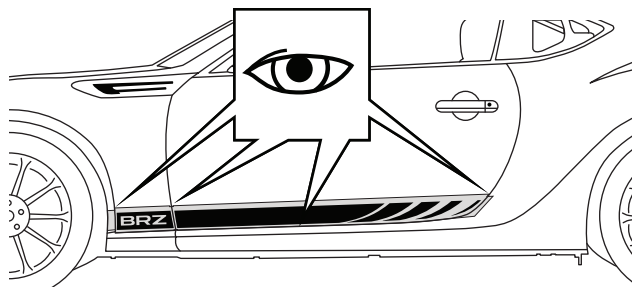
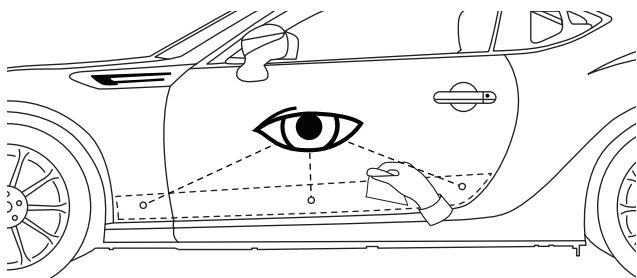

1 Alcool

Laver le véhicule soigneusement avec un linge doux non pelucheux. Essuyer le panneau à l’endroit où l’autocollant sera posé à l’aide de lingettes imbibées d’alcool. Laisser la surface sécher complètement.

2 Faire un ajustement à sec

Aligner l’autocollant en position en utilisant les languettes de manipulation, les encoches de porte et les bords de panneau comme référence.

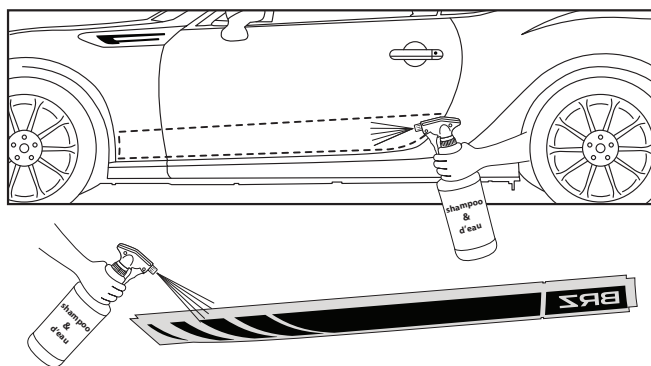
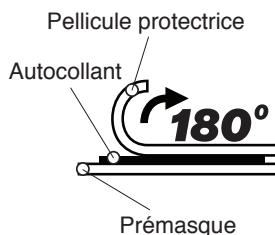
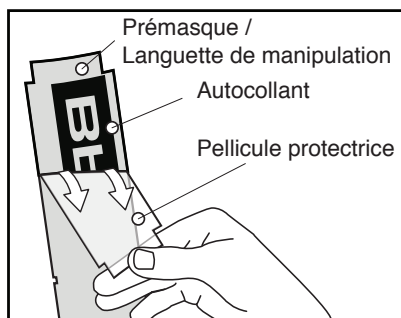









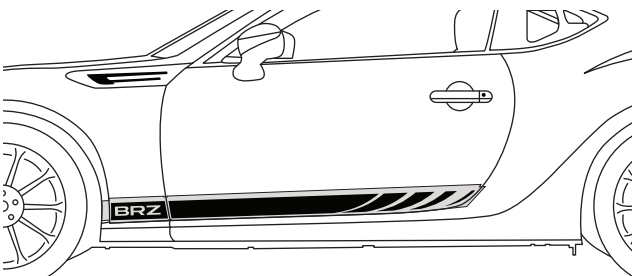
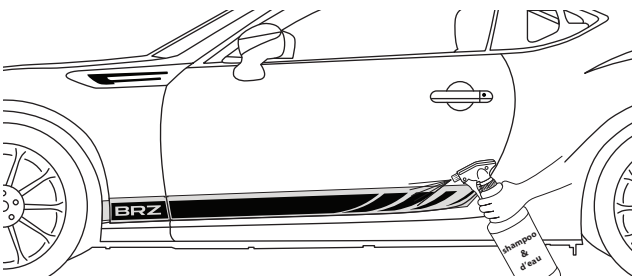

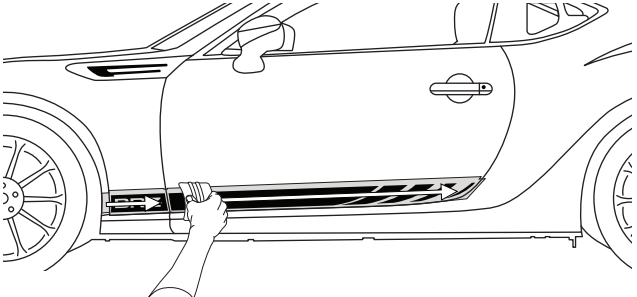
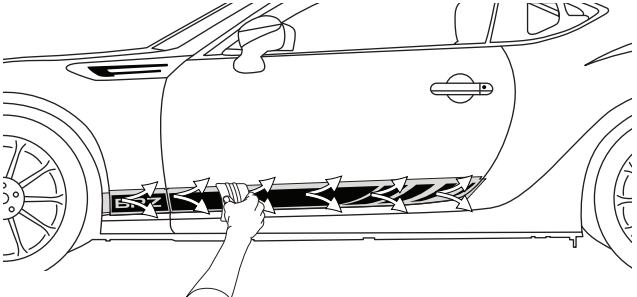
3 Enlever la pellicule protectrice

Dépose la pellicule protectrice de l’autocollant comme illustré. Pour éviter toute contamination, essayer de ne pas trop toucher le côté adhésif de l’autocollant; utiliser les languettes de manipulation.

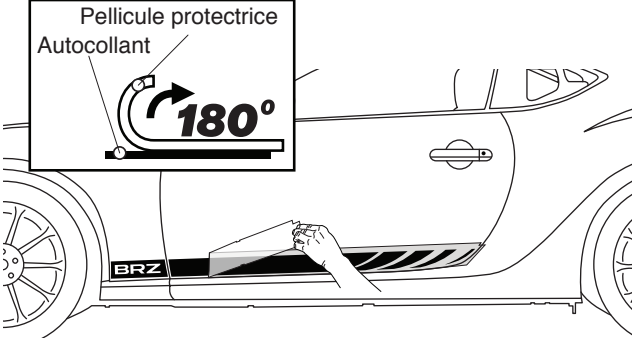
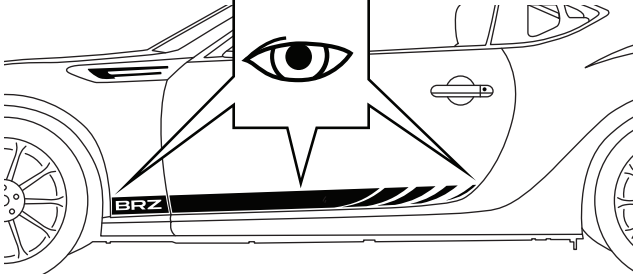
4 Vaporiser le véhicule / l’adhésif de l’autocollant

Vaporiser et saturer le côté adhésif de l’autocollant avec la solution de savon et d’eau. Vaporiser ensuite la surface du véhicule à l’endroit où l’autocollant sera posé.

				
5 Positionner les autocollants	6 Vaporiser le prémasque de l'autocollant			
 <p>Tout en vous servant des languettes de manipulation, aligner l'autocollant en position. Cela permet à la pièce de glisser sur la surface jusqu'à ce qu'elle soit à la bonne position.</p>	 <p>Vaporiser la surface supérieure du prémasque avec la solution d'eau et de savon. Cela permet au racloir de glisser facilement sur la surface.</p>			
				
7 Racler l'autocollant	8 Racler l'autocollant			
 <p>Faire attention pour ne pas rayer la surface peinte avec le racloir. En exerçant une pression ferme et uniforme et en effectuant des mouvements qui se chevauchent, mettre l'autocollant en position à l'aide du racloir.</p>	 <p>Faire attention pour ne pas rayer la surface peinte avec le racloir.  En travaillant du centre vers l'extérieur, s'assurer que chaque partie de l'autocollant est bien collée à la surface du véhicule.</p>			
	<p>* (Répéter les étapes 1 à 10 sur le côté opposé du véhicule.)</p> 			
9 Retirer le prémasque	10 Inspecter l'autocollant			
 <p>Retirer LENTEMENT ET AVEC PRÉCAUTION le masque de l'autocollant en le soulevant et en le tirant vers l'arrière à un angle de 180° comme illustré. Si l'autocollant se soulève avec le prémasque, racler à nouveau la zone. </p>	 <p>Si des bulles sont présentes après le retrait du prémasque, envelopper le racloir d'une serviette et tenter de pousser la bulle sur le côté de l'autocollant en faisant attention. S'il est impossible de déplacer la bulle, utiliser une aiguille à coudre pour percer la bulle et extraire la solution restante se trouvant sous l'autocollant. </p>			
<p>DESCRIPTION Graphiques extérieurs BRZ, côté</p>	<p>ISSUE 00</p>	<p>DATE 11/17/20</p>	<p>SUBARU OF AMERICA</p>	<p>PAGE 7 / 8</p>

Nettoyage et entretien

Éléments à vérifier		Résultats de la vérification
	Une fois l'autocollant posé, ne pas laver le véhicule à haute pression avant 72 heures.	

Vérification visuelle

Éléments à vérifier		Résultats de la vérification
	Vérifier que tous les bords sont bien collés.	