



SUBARU

PART NUMBER: J101SSJ600
NUMÉRO DE PIÈCE :

DESCRIPTION: Forester Wilderness Splash Guard Kit
DESCRIPTION : Nécessaire de pare-boue pour le Forester Wilderness

INSTALLATION INSTRUCTIONS
INSTRUCTIONS D'INSTALLATION

KIT CONTENTS:
CONTENU DE L'ENSEMBLE

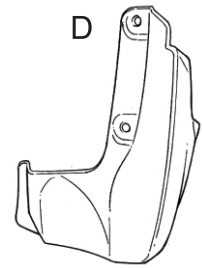
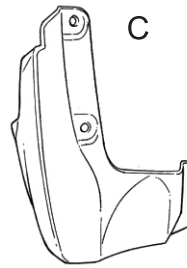
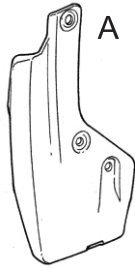

x4

E

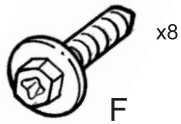

x8

F



x2

G



x6

H

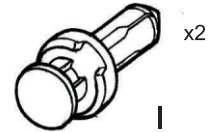

x2

I

TOOLS REQUIRED
OUTILS REQUIS



8mm

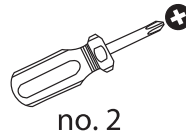
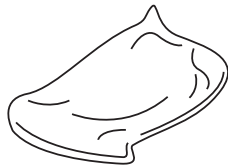

no. 2

NOTICE: Ground clearance is reduced when splashguards are installed

AVIS: La garde au sol est réduite lorsque les pare-boue sont installés

MEANING OF CHARACTERS:
SIGNIFICATION DES SYMBOLES :



Remove
Enlever



Install
Installer



Re use
Réutiliser



Discard
Jeter/recycler

1 Front Installation
Installation à l'avant

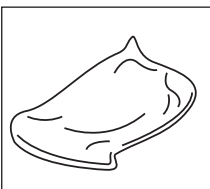
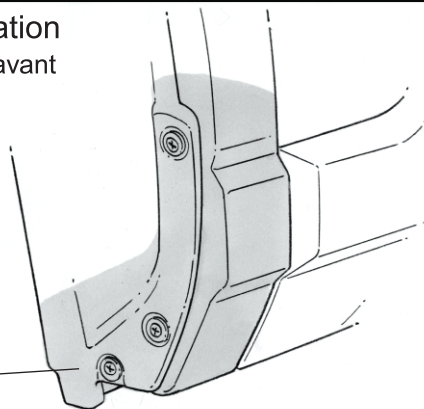

2

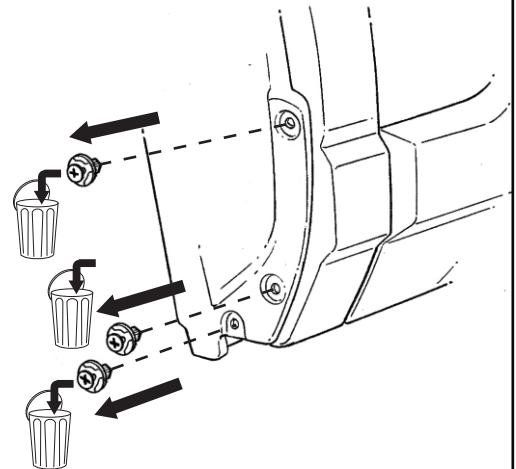

no. 2

3

Install clip over metal panel

H

4

E

B

5

F 3

F 2

F 1

IMPORTANT
Push Up & In
While Tightening
1-2 Then 3

8mm

Screw Torque:
1.0 - 1.5 Nm (9~13 in-lb)
Couple de serrage des vis :
1,0 à 1,5 N.m (9 à 13 po-lb)

6 Rear Installation
Installation à l'arrière

7

no. 2

8

G

9

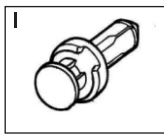
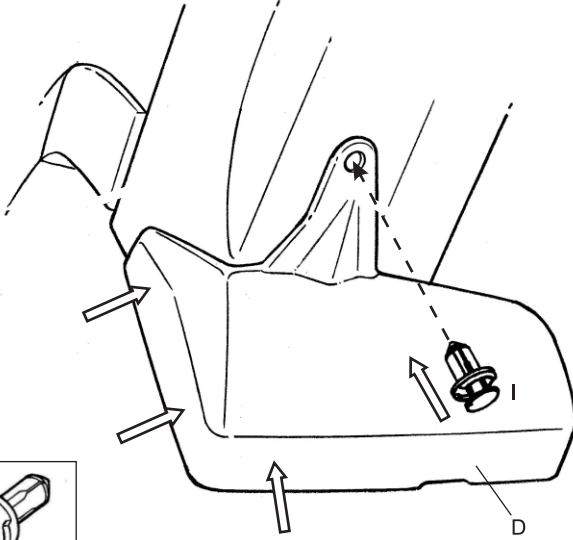

10

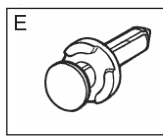
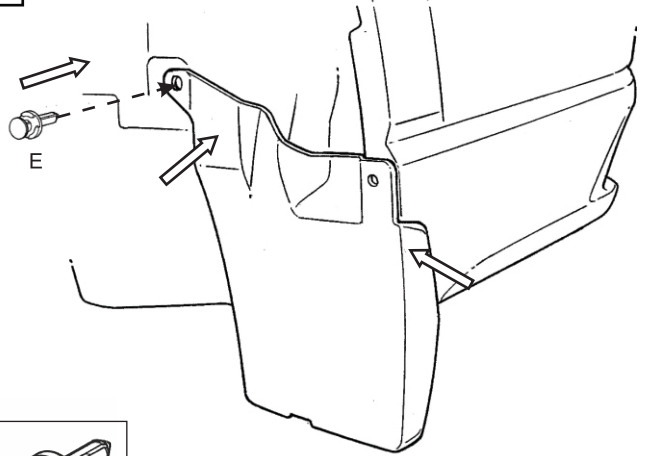

11

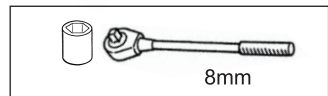
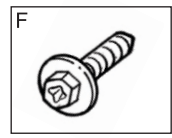
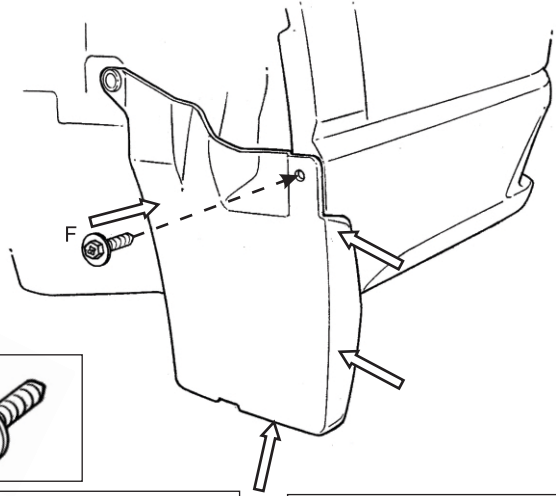

8mm

Screw Torque:
 1.0 - 1.5 Nm (9~13 in-lb)
 Couple de serrage des vis :
 1,0 à 1,5 N.m (9 à 13 po-lb)

12

- Repeat steps for the other side of the vehicle
- Reprendre les mêmes étapes de l'autre côté du véhicule.