



Accessory Grille

Installation Manual

Genuine Part Number: J1010FN500

Applicable Model: 2024+ CROSSTREK

Thank you for purchasing the Subaru Genuine Accessory Grille.
 This manual describes the procedure to install the Accessory Grille on the CROSSTREK.
 Be sure to read this manual before installing this product and follow the instructions described below.

Component Parts

| No. | Accessory Grille | |
|-----|------------------|----------|
| | Part Name | Quantity |
| 1 | Accessory Grille | 1 |
| 2 | Camera cover | 1 |
| 3 | Screw M4 x 12 mm | 2 |
| 4 | Cushion Tape | 2 |
| | | |

⚠ Installation Precautions

For your safety, important instructions that should be observed are shown with the following symbols in this Installation Manual.

⚠ CAUTIONThis refers to situations in which injury may occur or property may be damaged if the caution instructions are not followed.

👉 NOTEThis denotes things that you should be made aware of so you can do the work quickly.

- (1) Park the vehicle on a level place, apply the parking brake, and use wheel chocks.
- (2) Make sure to arrange vehicle parts by part when removing them so that you do not lose the tapping screws, nuts and bolts, and so you do not mistaken them when reinstalling the vehicle components. Also, pay due attention not to damage the vehicle and the removed parts during work.
- (3) Follow the Service Manual when handling the battery.
- (4) To prevent damage to the vehicle and vehicle parts when removing vehicle parts and installing the product, be sure to perform the work on a Protective Sheet.

Installation of Parts

• Use the proper size of tools.

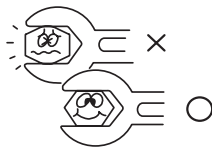

• Pay attention to the back side and do not allow any wire harness to get caught.

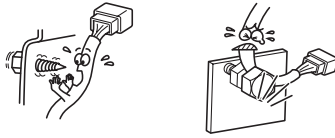

After Completion of Installation

• Be sure to reassemble all the vehicle parts that have been removed.



• When degreasing and wiping the adhesive area of the double-sided tape using Degreaser, take extra care to ensure to keep open flames away from the area.

• Working at temperatures below 15°C (59°F) will reduce the adhesive strength of the double-sided tape, causing it to drop-off and peel off.

Warm up the double-sided tape area and the application surface with a Dryer before performing the adhesion work.

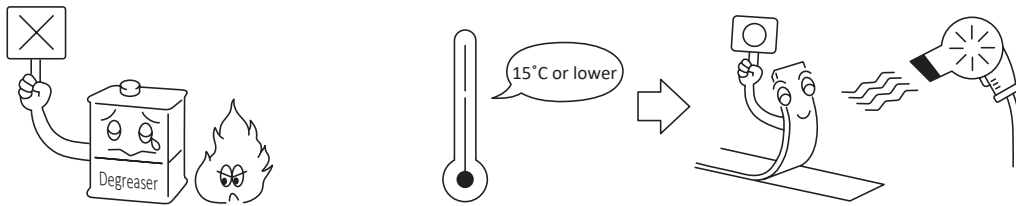

⚠ CAUTION

Follow the Service Manual when performing the work.

Tools Required

Combination Wrench (10 mm), Phillips-head Screwdriver, Flathead Screwdriver, Torque Screwdriver, Clip Remover, Protective Tape, Blanket or Protective Sheet, Masking Tape, Cloth, Degreaser (nonane is recommended).

Post-installation Diagram

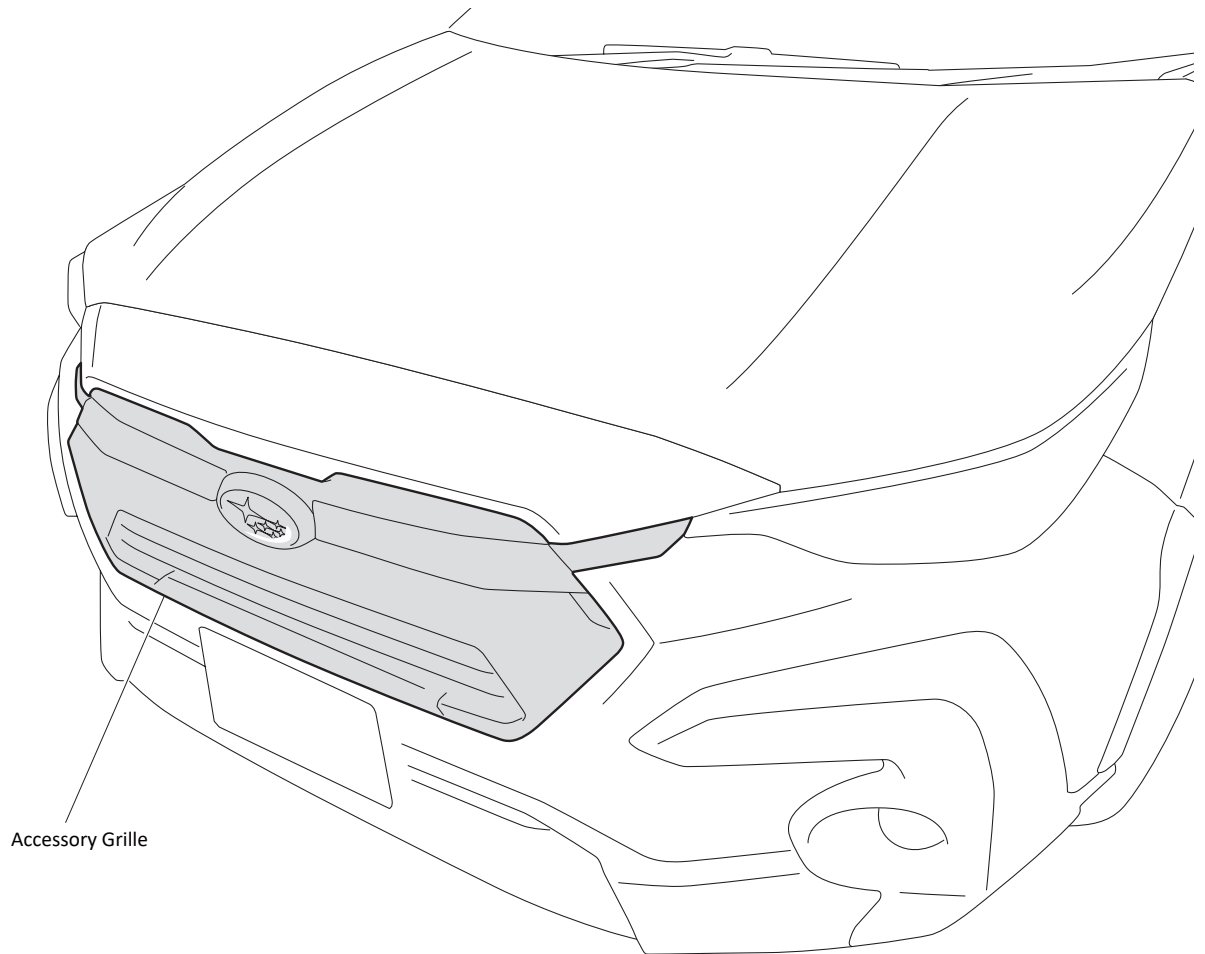

Installation Procedure

The figure shows the left side.

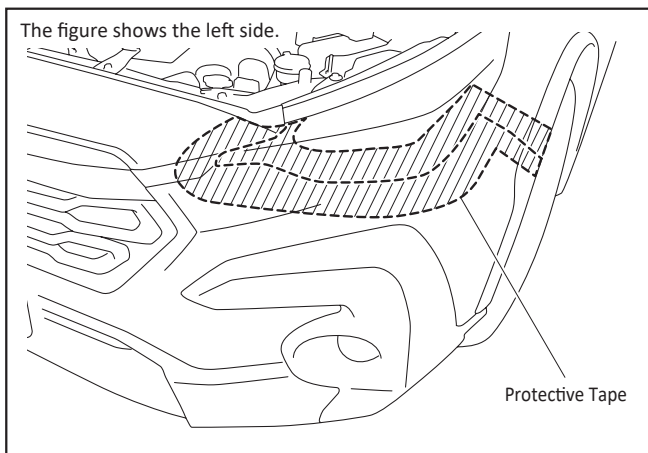

TG-BJ-A01

1. Applying Protective Tape

- (1) Apply Protective Tape to the shaded area in the figure.
- (2) Repeat the same procedure for the right side.

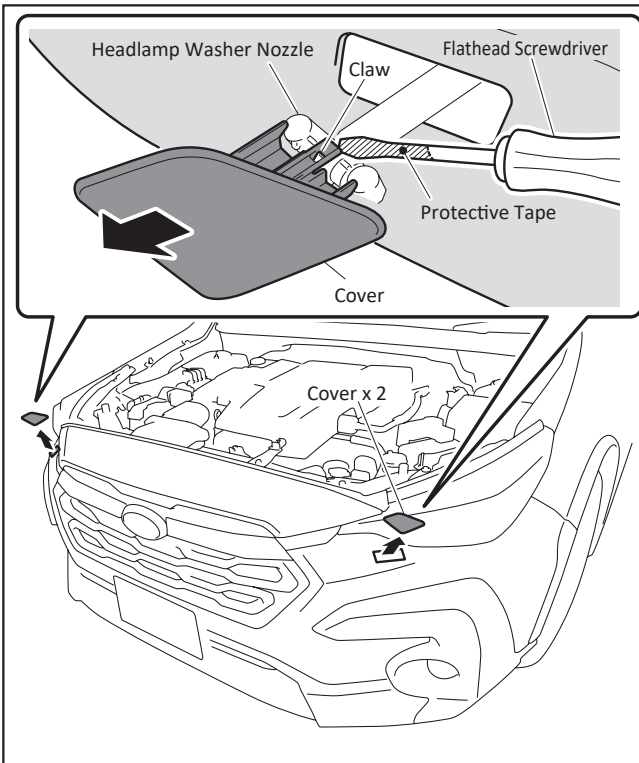

TG-BJ-A02

2. Removing the Headlamp Washer Nozzle Cover

<For vehicles with a Head Lamp Washer>

- (1) Pull out the Headlamp Washer Nozzle, disengage the Claw, and remove the cover.

⚠ CAUTION

Unless otherwise stated, the removed vehicle parts will be reused, so be careful not to misplace them. (Adopt this practice throughout the rest of the procedure).

The figure shows the left side.

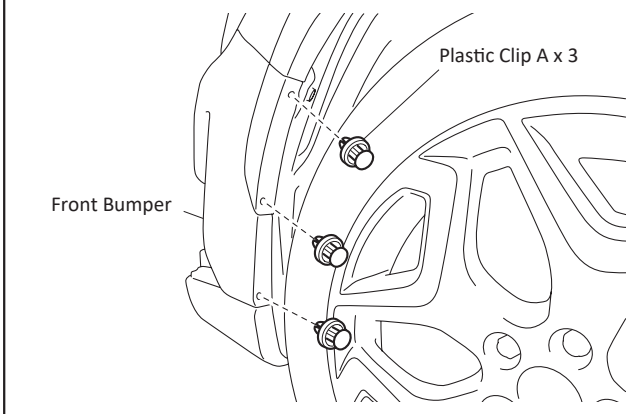

TG-BJ-A03

3. Removing the Front Bumper

- (1) Remove Plastic Clip A (3 pcs).
- (2) Repeat the same procedure for the right side.

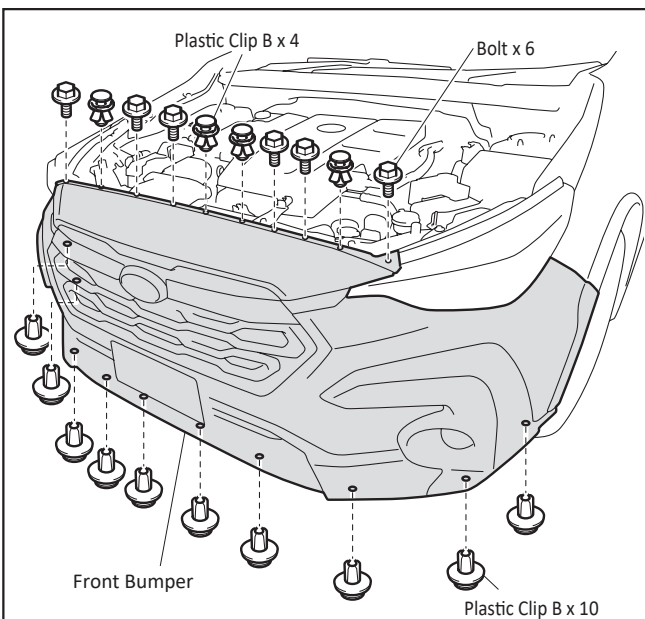

TG-BJ-A04

- (3) Remove the Bolts (6 pcs) and Plastic Clip B (bottom 10 pcs) (top 4 pcs).

The figure shows the left side.

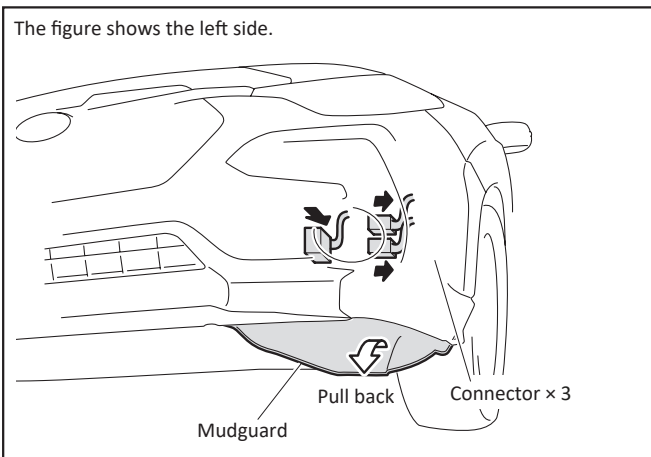

TG-BJ-A05

- (4) Pull back the Mudguard and disconnect the connectors.
- (5) Repeat the same procedure for the right side.

NOTE

The number of connectors differs depending on the specifications of your vehicle.

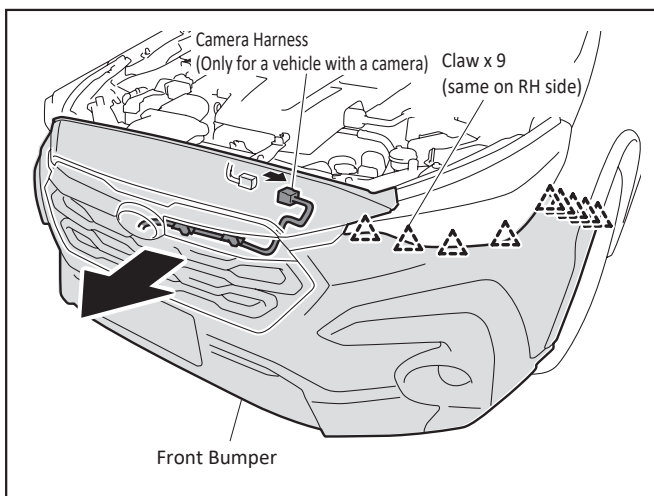

TG-BJ-A06

- (6) Disengage the Claws (18 places on right and left sides) and remove the Front Bumper.

CAUTION

- (1) Place the Front Bumper on a blanket or Protective Sheet so that it will not get scratched.
- (2) For vehicles with a camera, make sure to remove the camera harness.

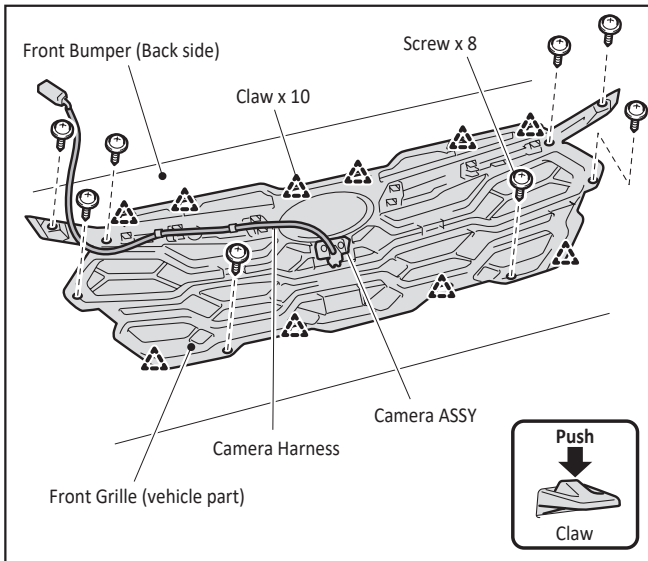

TG-BJ-A07

4. Removing the Front Grille <For vehicles with a camera>

- (1) Remove the Screws (8 pcs).
- (2) Disengage the Claws (10 places) and remove the Front Grille (vehicle part).

⚠ CAUTION

Be sure to remove or install the Front Bumper above a blanket or Protective Sheet so that it will not get scratched.
(Adopt this practice throughout the rest of the procedure).

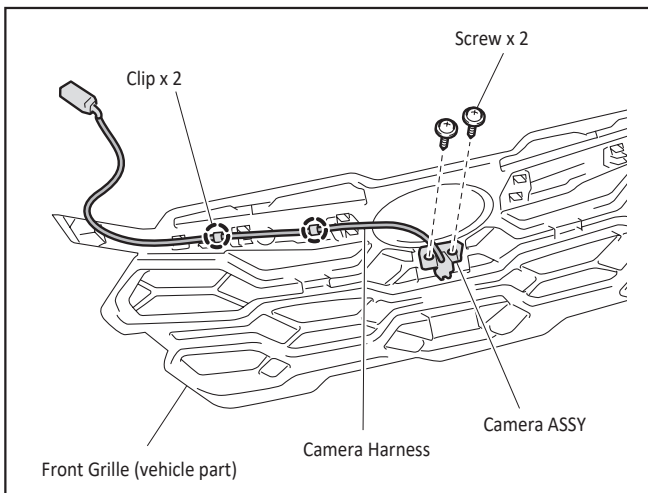

TG-BJ-A08

- (3) Remove the Clips (2 places).
- (4) Unscrew the Screws (2 pcs) and then remove the Camera ASSY.

👉 NOTE

Front Grille (vehicle part) will not be used again.

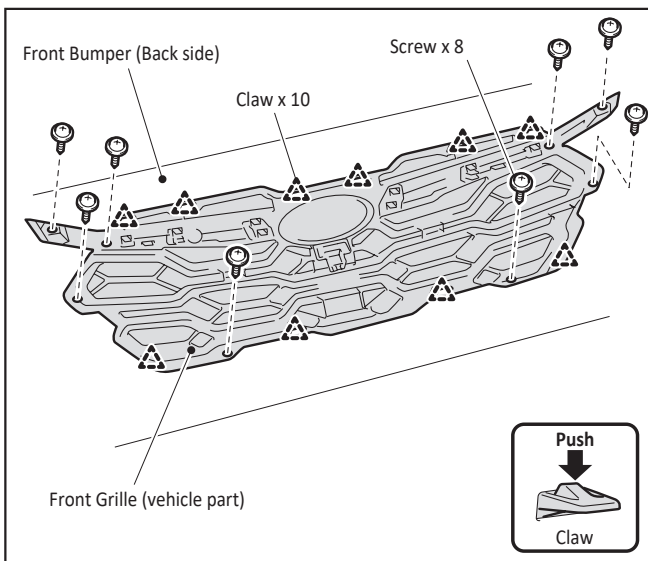

TG-BJ-A09

<For vehicles without a camera>

- (1) Remove the Screws (8 pcs).
- (2) Disengage the Claws (10 places) and remove the Front Grille (vehicle part).

⚠ CAUTION

Be sure to remove or install the Front Bumper above a blanket or Protective Sheet so that it will not get scratched.
(Adopt this practice throughout the rest of the procedure).

👉 NOTE

Front Grille (vehicle part) will not be used again.

<For vehicles without a camera>

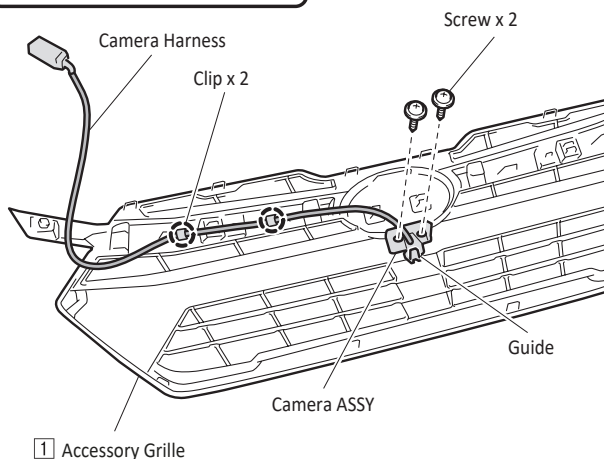
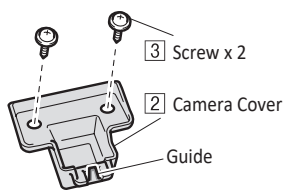

TG-BJ-A10

5. Installing the Camera or Camera Cover

<For vehicles with a camera>

- (1) Attach the Camera ASSY to **1** Accessory Grille with the Screws (2 pcs) and Guide (1 place).

Tightening torque: 1.1 N·m ± 0.2 (9.7 inch*lbs ± 1.8)

⚠ CAUTION

Do not use the M4 Screws (2 pcs) included with the product.

- (2) Engage the Clips (2 places) to secure the Camera Harness.

<For vehicles without a camera>

- (1) Using **3** Screws (2 pcs) and Guide (1 place), attach **2** Camera Cover to **1** Accessory Grille.

Tightening torque: 1.1 N·m ± 0.2 (9.7 inch*lbs ± 1.8)

⚠ CAUTION

Use the Screws (2 pcs) and camera cover included with the product.

<For vehicles without a camera>

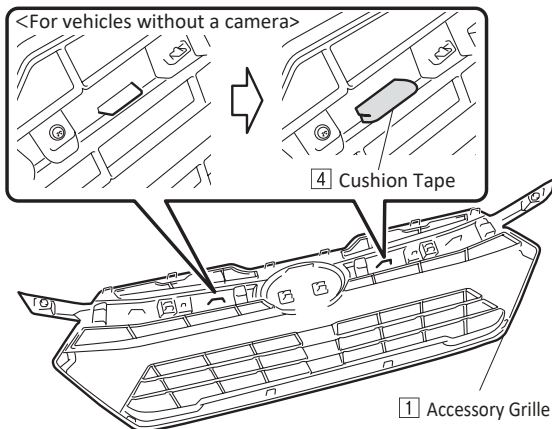

TG-BV-A18

- (2) Apply the **4** Cushion Tapes (2 pcs) at the areas indicated in the illustration of the **1** Accessory Grille.

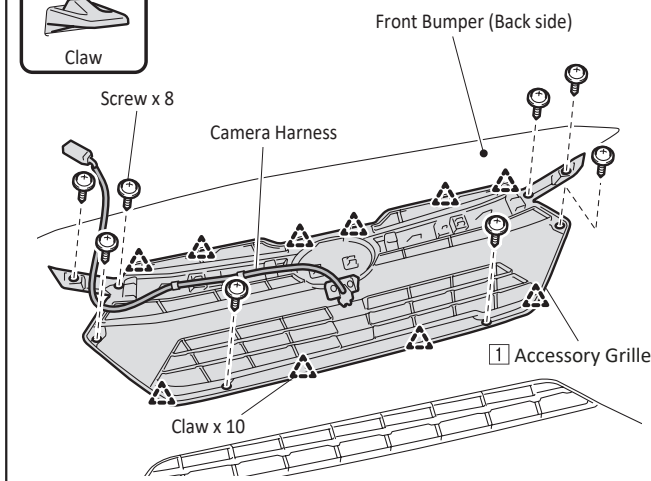

TG-BJ-A11

6. Installing the Accessory Grille

<For vehicles with a camera>

- (1) Engage the Claws (10 places) to attach **1** Accessory Grille to the Front Bumper.

⚠ CAUTION

Check that the Claws (10 places) are properly engaged.

- (2) Secure **1** Accessory Grille with the Screws (8 pcs).

⚠ CAUTION

Tightening the screw with an electric drill or another tool with a high torque specification may damage the screw, so use a Phillips-head Screwdriver to tighten the screw by hand.

(FYI: Tightening torque = 1.5 N·m ± 0.3)
(13.3 inch*lbs ± 2.7)

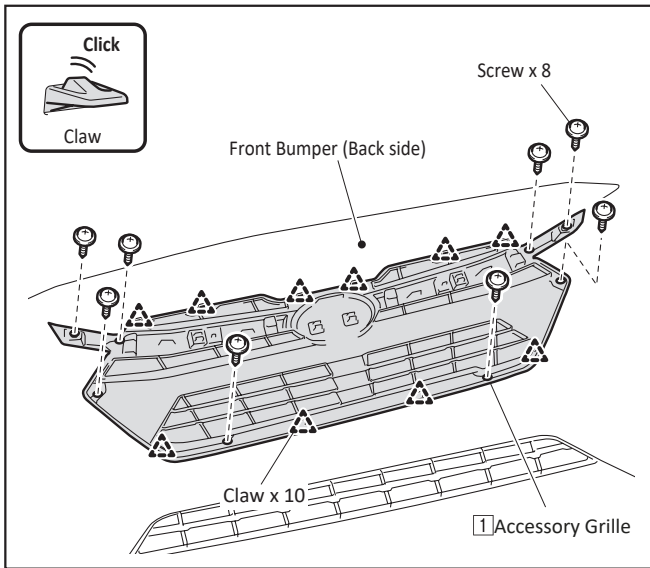

TG-BJ-A12

<For vehicles without a camera>

- (1) Engage the Claws (10 places) to attach **1** Accessory Grille to the Front Bumper.

⚠ CAUTION

Check that the Claws (10 places) are properly engaged.

- (2) Secure **1** Accessory Grille with the Screws (8 pcs).

⚠ CAUTION

Tightening the screw with an electric drill or another tool with a high torque specification may damage the screw, so use a Phillips-head Screwdriver to tighten the screw by hand.

(FYI: Tightening torque = $1.5 \text{ N}\cdot\text{m} \pm 0.3$)

(13.3 inch*lbs \pm 2.7)

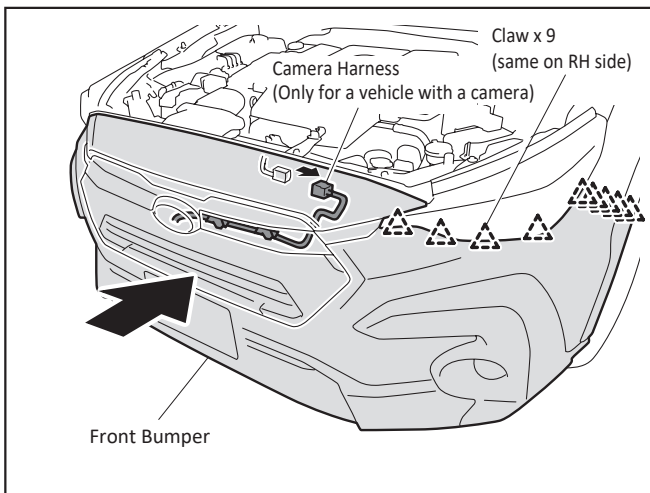

TG-BJ-A13

7. Reinstalling the Front Bumper

- (1) Engage the Claws (18 places) and reinstall the Front Bumper.

⚠ CAUTION

- (1) Check that the Front Bumper Claws are set in the correct position before pushing them in to engage them. Not doing so may damage the Front Bumper.

- (2) For vehicles with a camera, make sure to connect the camera harness.

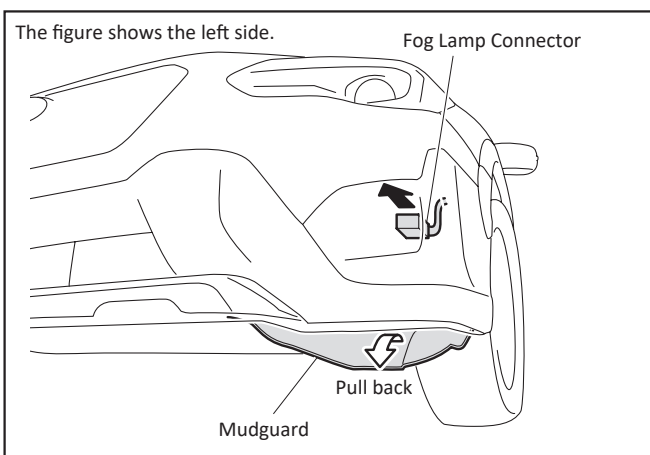

TG-BJ-A14

- (2) Pull back the Mudguard and connect the connectors.
- (3) Repeat the same procedure for the right side.

👉 NOTE

The number of connectors differs depending on the specifications of your vehicle.

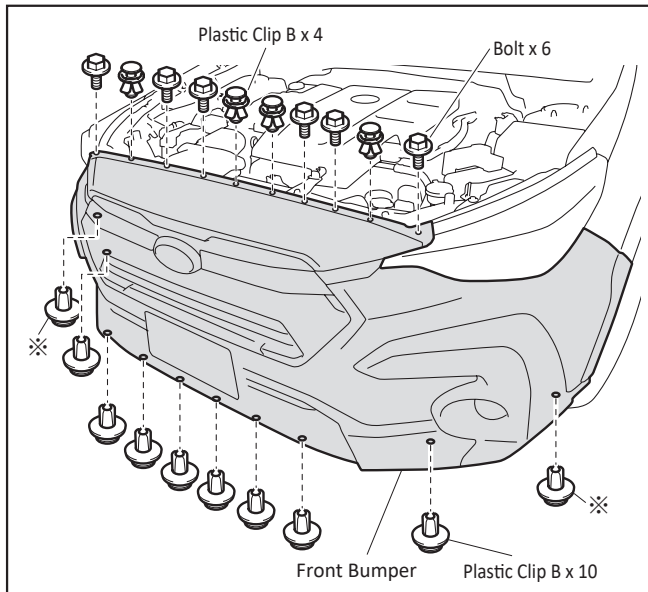

TG-BJ-A15

The figure shows the left side.

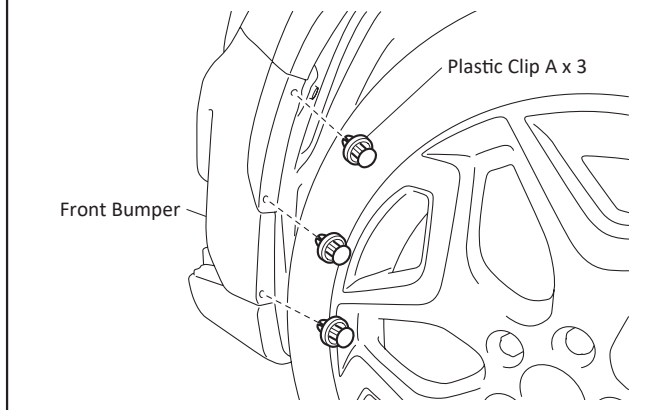

TG-BJ-A16

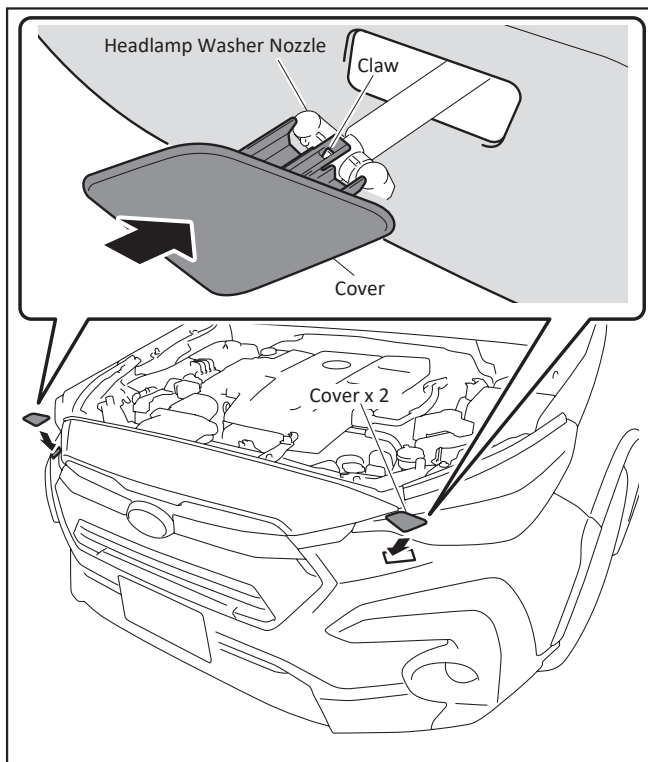

TG-BJ-A17

- (4) Secure the Front Bumper with the Bolts (6 pcs) and Plastic Clip B (bottom 10 pcs) (top 4 pcs).

Tightening torque: 7.5 N·m (0.8kgf-m, 5.5ft-lb)

CAUTION

Follow the installation order to secure the Fender Liner and Skirt to the Front Bumper with Plastic Clip B (2 places), which is indicated in the figure with an asterisk (※).

Cross-sectional View

※Installation order

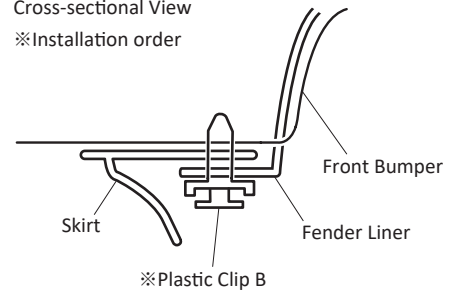

- (5) Secure the Front Bumper with Plastic Clip A (3 pcs).

- (6) Repeat the same procedure for the right side.

8. Reinstalling the Head Lamp Washer Nozzle Cover
<For vehicles with a Head Lamp Washer>

- (1) Pull out the Headlamp Washer Nozzle, engage the Claw, and attach the cover.

Post-installation Inspection

- (1) Remove all Protective Tape.
- (2) Follow the Service Manual when performing the work.
- (3) The calibration is required to be performed if the Multi-View Monitor system is equipped.
Confirm the detail of the work with the Service Manual, and be sure to perform it without omission.

CAUTION

- (1) Check that the Fog Lamps turn on.
- (2) Check that the camera images are displayed correctly on the multifunction display.
- (3) Re-check that the Plastic Clips and Bolts are not loose and the parts are properly secured.

Revision History

|  | Description | Revision Date |
|---|---------------|---------------|
| △00 | First version | 2022. 9 |
| | | |