



SUBARU

IMPREZA FOG LAMP KIT

INSTALLATION INSTRUCTION

PART No. H4510FL000



IMPORTANT

1. The installation should be carried out by an authorized Subaru dealer.
2. Pay special attention not to damage vehicle components when removing / installing them.
3. Route the wiring so that it cannot be abraded against any sharp edges.
4. Refer to the vehicle service manual.
5. Check that the vehicle's electronic devices are operating normally. Be sure to make note of the contents of the memory of electronic devices such as the preprogrammed radio channels.



Components

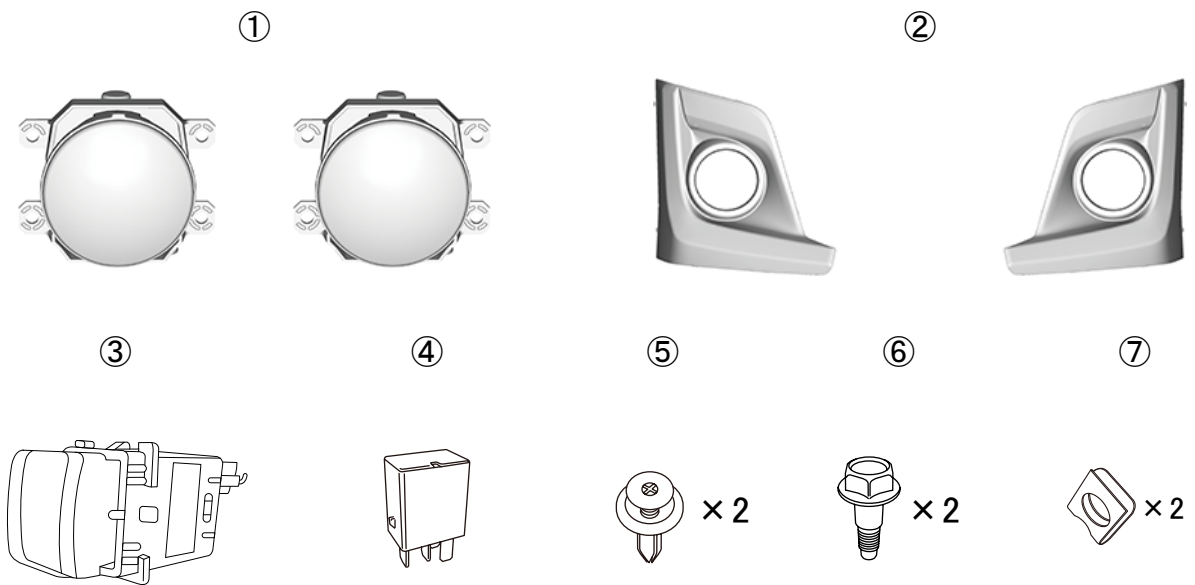

Tools

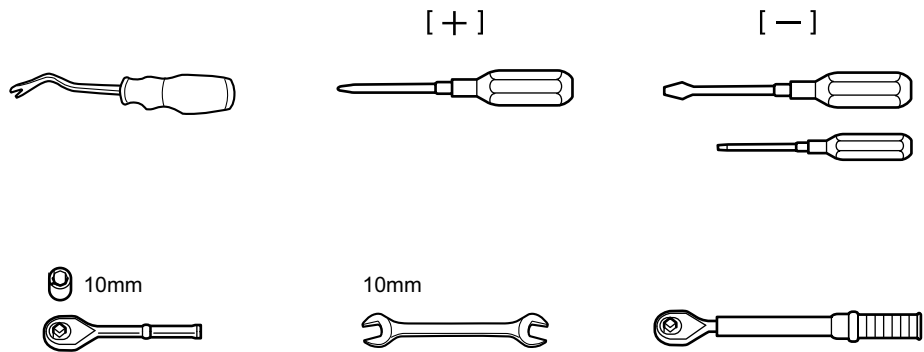

1

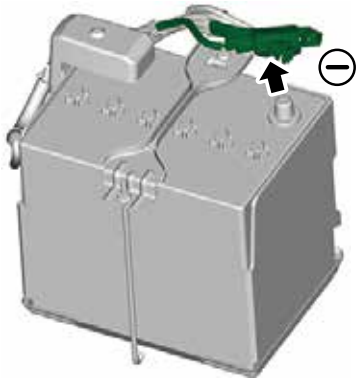

After removing the battery terminal, wait 60 seconds before proceeding to the next procedure.

2

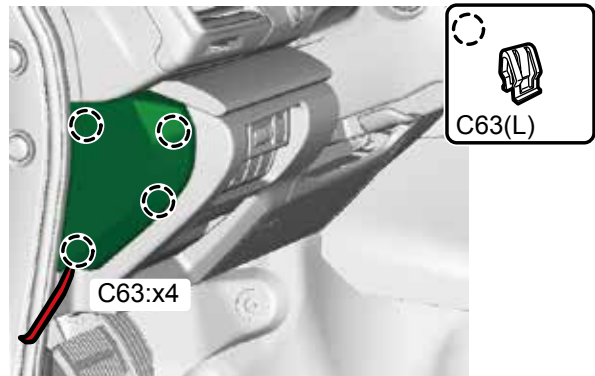

3

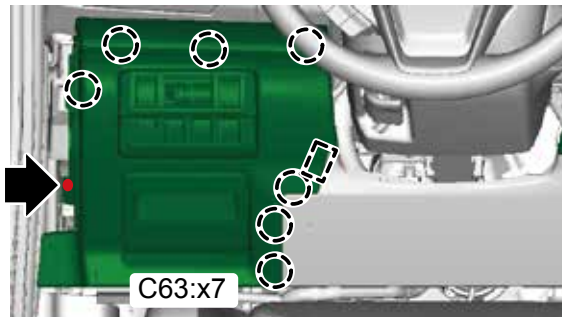
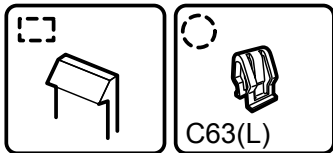

4

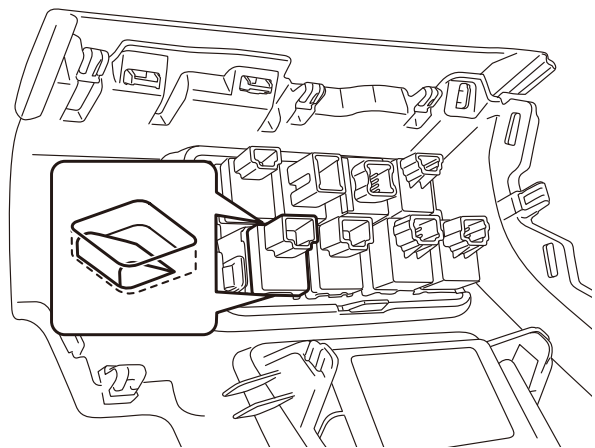

Rear of lower instrument panel shown.

5

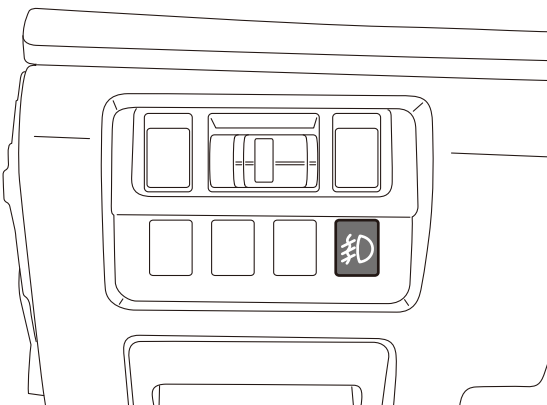

6

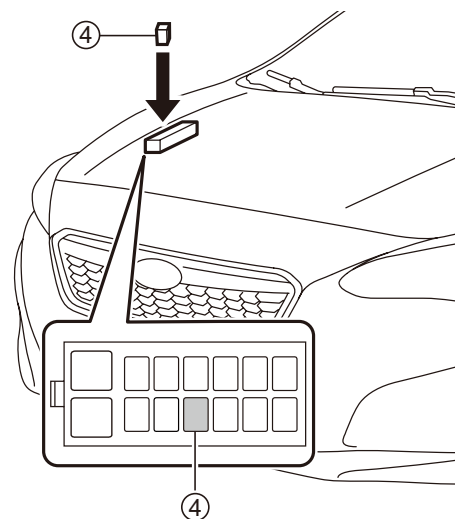

7

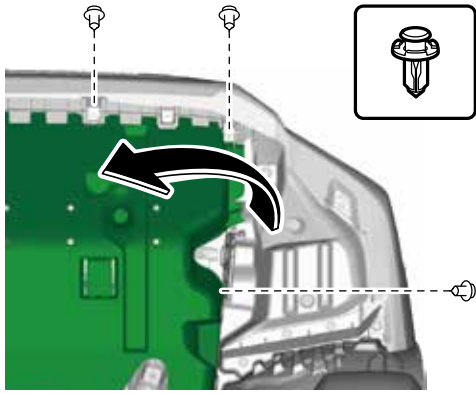

8

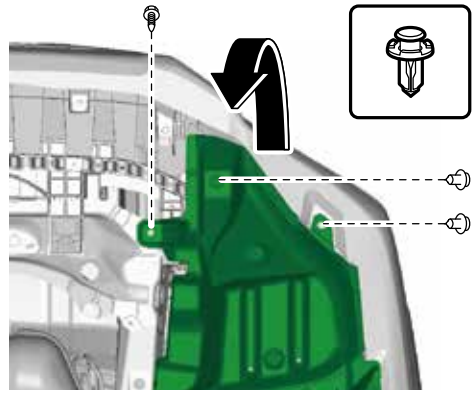

9



10

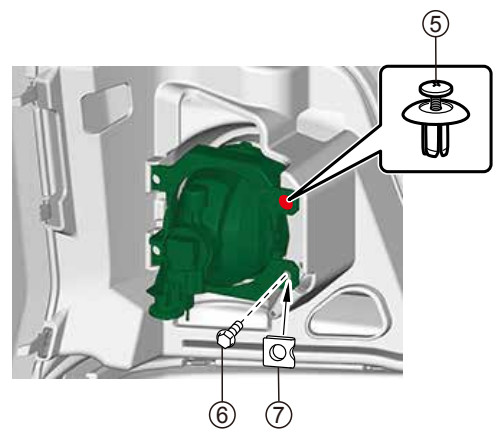

11

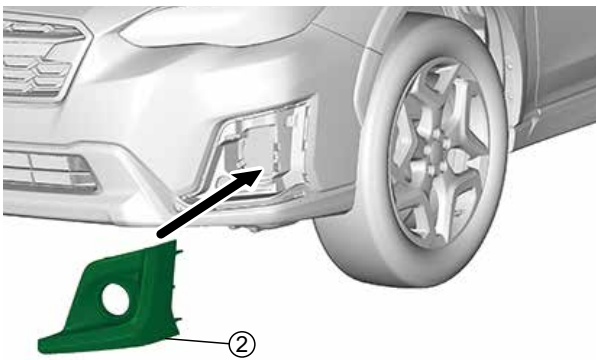

12

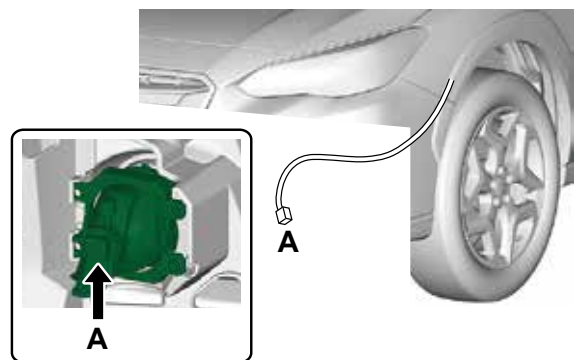

13

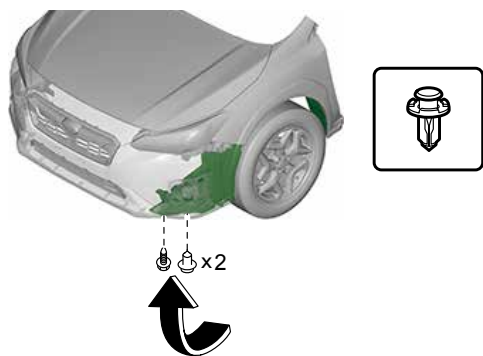

14



15

