

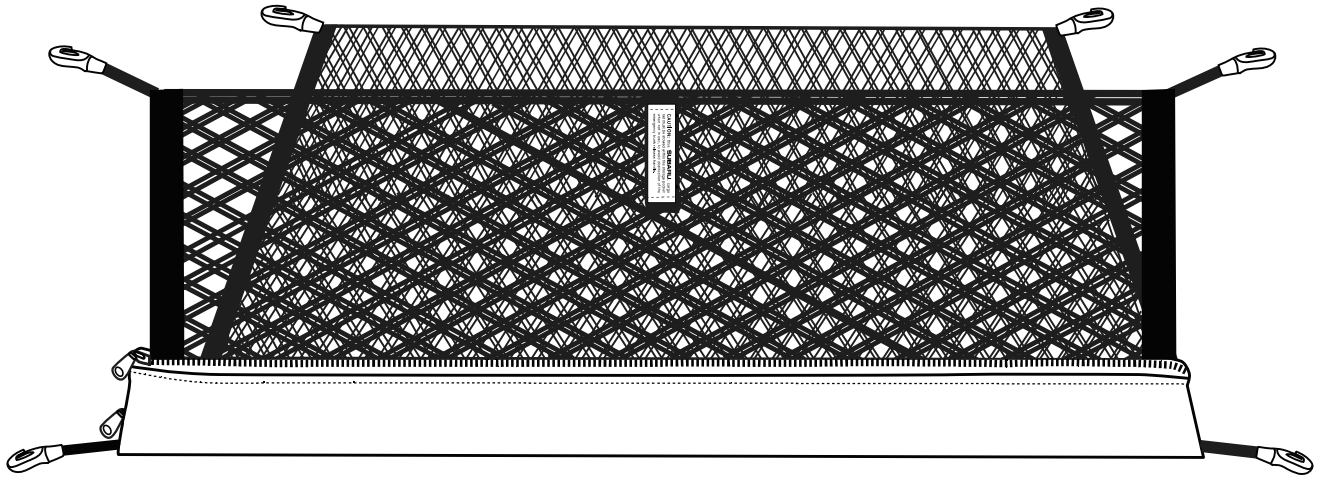





A KIT CONTENTS:**1X****TOOLS REQUIRED: NONE****Meaning of Characters:**
 : Remove

 : Install

 : Disconnect

 : Connect

 : Location of pre-arranged mark

 : Driver side rear cargo area

 : Passenger side rear cargo area

T : Tightening Torque

 : Loosen

 : Discard

 : Recyclable

 : View

NOTE: Installation steps shown below are for the drivers side of the vehicle.
Please follow the same steps for the passengers side.

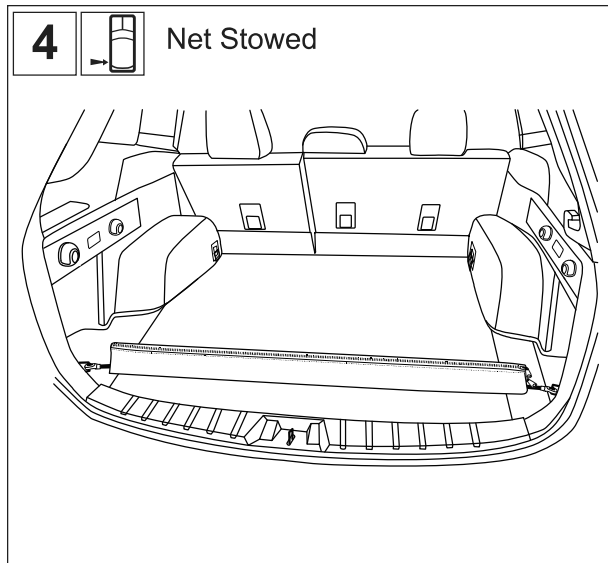
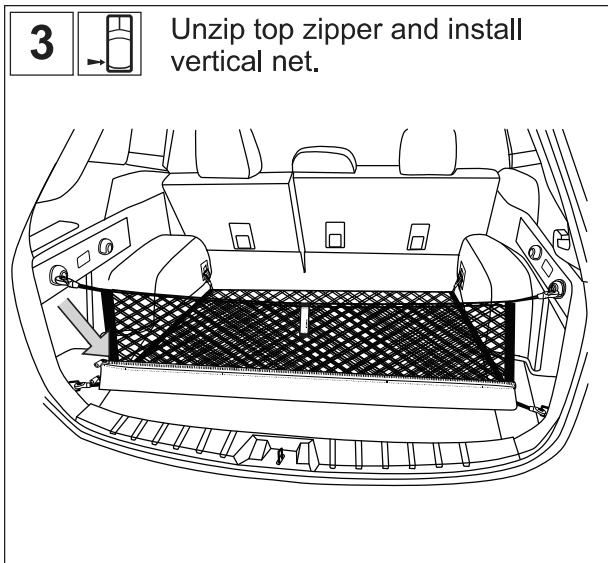
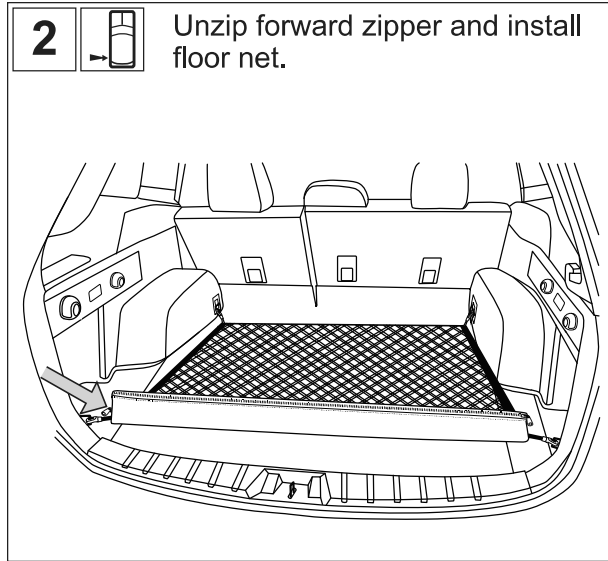
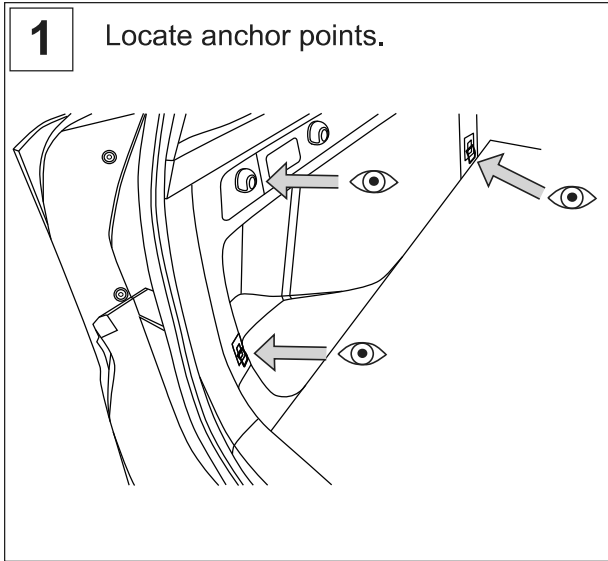

NOTE: Either net can be installed independently.

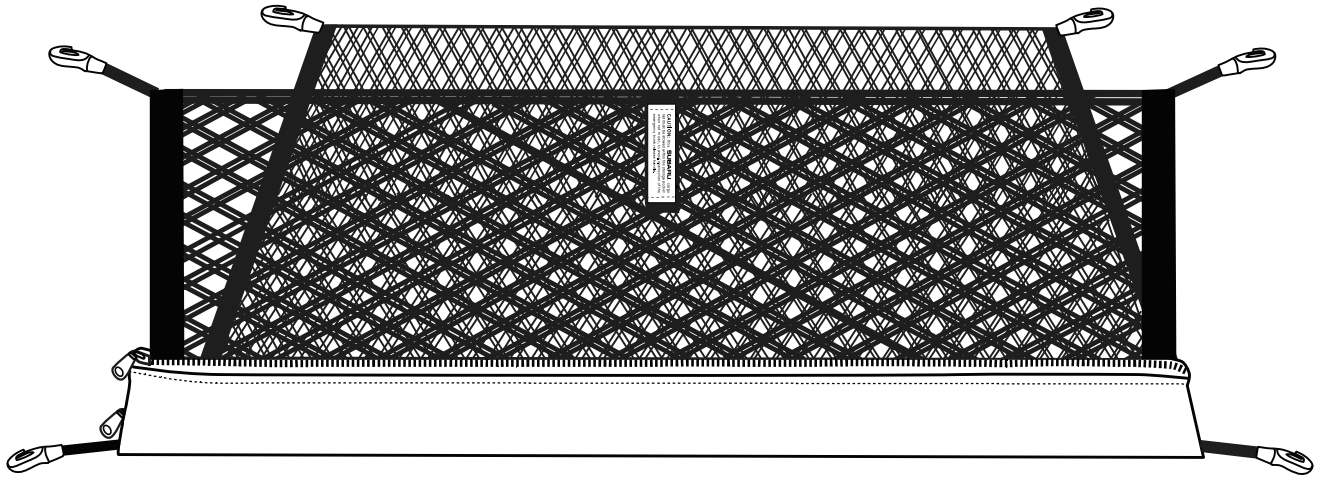
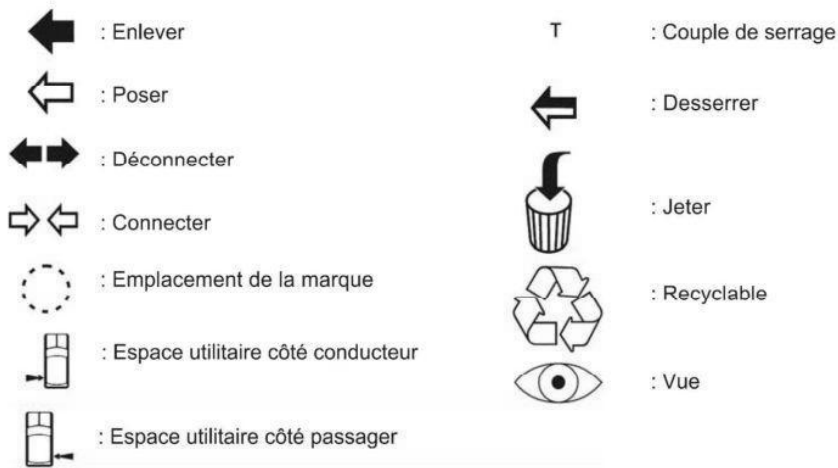
A CONTENU DU KIT:**1X****OUTILS REQUIS: AUCUN****Signification des symboles:**

Remarque: Les opérations d'installation sont identiques pour l'autre côté du véhicule.

1 Localiser les points d'ancrage.

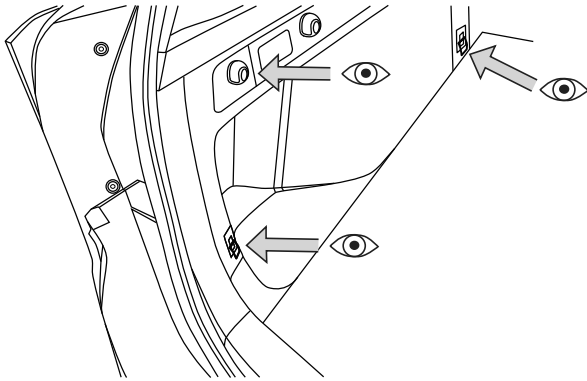

2 Ouvrir la fermeture éclair avant et installer le filet de retenue du plancher.

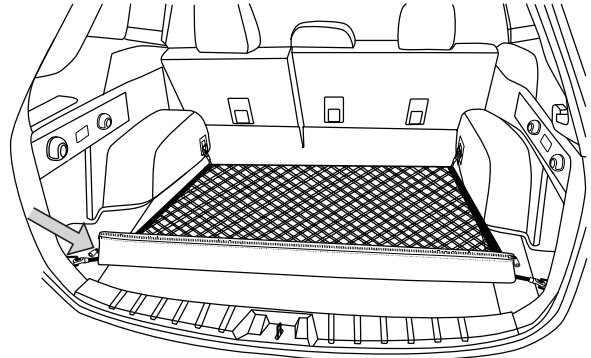

3 Ouvrir la fermeture éclair supérieure et installer le filet de retenue vertical.

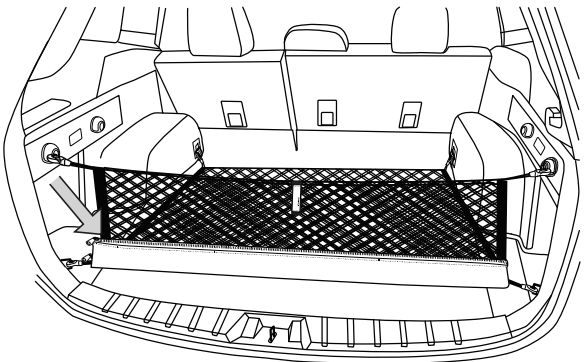

4 Filet rangé.

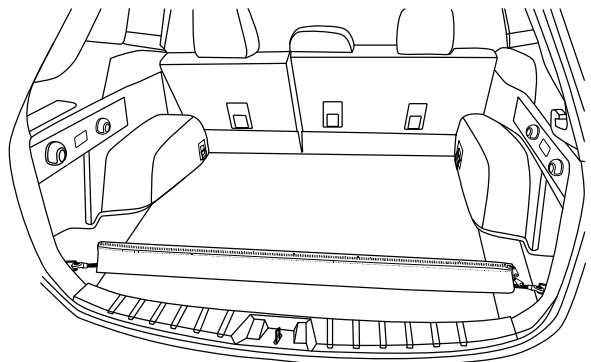

Remarque : Les filets peuvent être installés indépendamment l'un de l'autre.