



GB INSTALLATION INSTRUCTIONS

RU ИНСТРУКЦИЯ ПО УСТАНОВКЕ

D MONTAGEANLEITUNG

FR INSTRUCTIONS DE MONTAGE

I MANUALE DI INSTALLAZIONE

Description / Beschreibung / Designation / Descrizione / Наименование: **FUEL TANK UNDER GUARD**







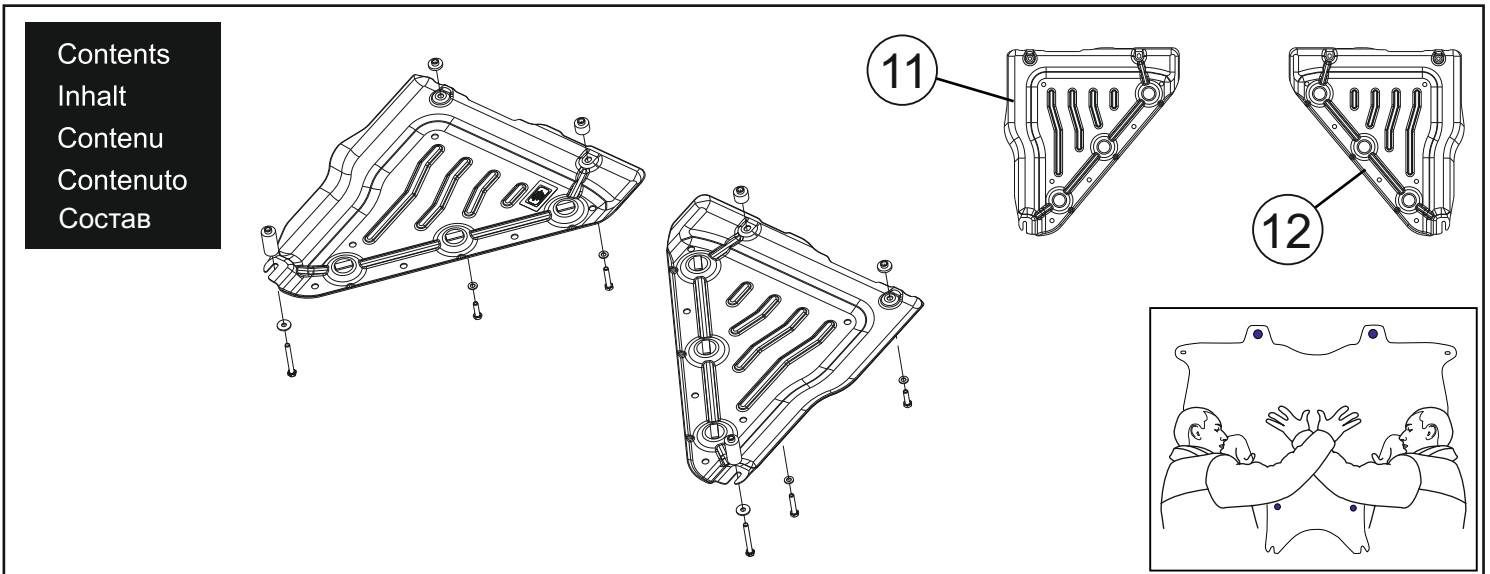

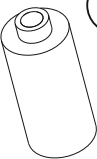

Application / Montage / Montage / Montaggio / Применение:

Part number / Teilenummer / Numéro de pièce / Codice pezzo / Номер: **E515SAN300**

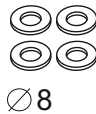
Fitting kit / Montagesatz / Kit de montage / Kit installazione / Комплект крепежа: **E515SAN310**



Fitting kit / montagesatz / kit de montage / kit installazione / комплект крепежа:

 1 2 x	 2 2 x	 3 2 x	 4 ∅8 2 x	 5 ∅8 4 x	 6 M8x30 2 x	 7 M8x45 2 x	 8 M8x70 2 x
 9 Alcohol Pad 1 x	 10 2 x						

Tools required / notwendige geräte/équipement nécessaire / attrezzatura richiesta / инструменты

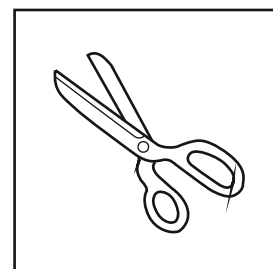
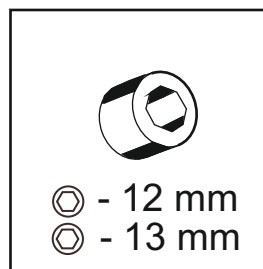
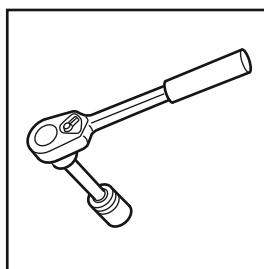
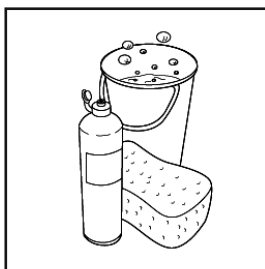

Installation
Installation
Installation
Installazione
Установка

Step 1...
Clean with soap and water
Step 2...
Clean with alcohol pad

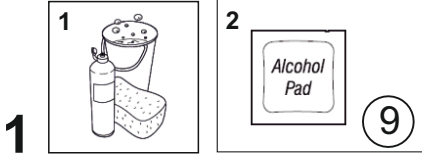
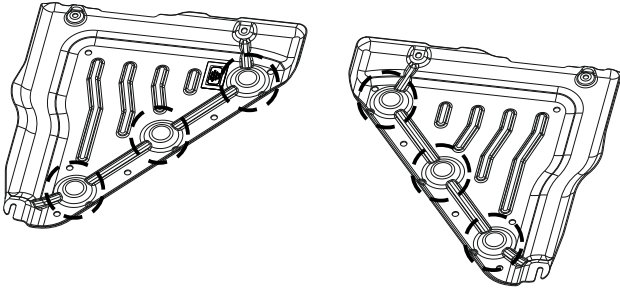

Step 3...
Cut Foam into 30mm strips (2 cuts)

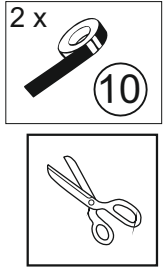
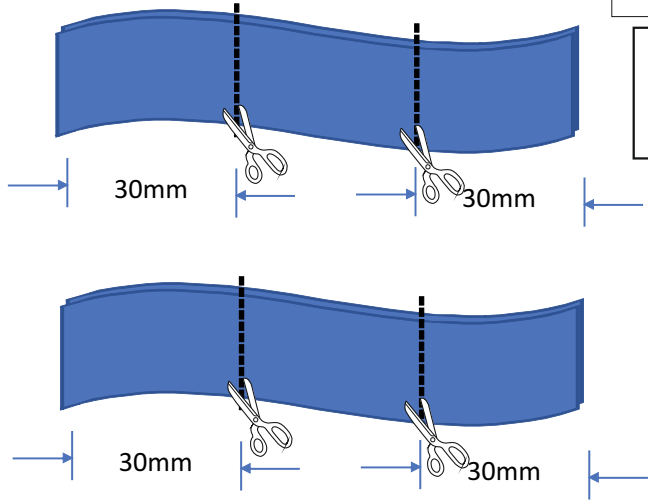

Step 4...

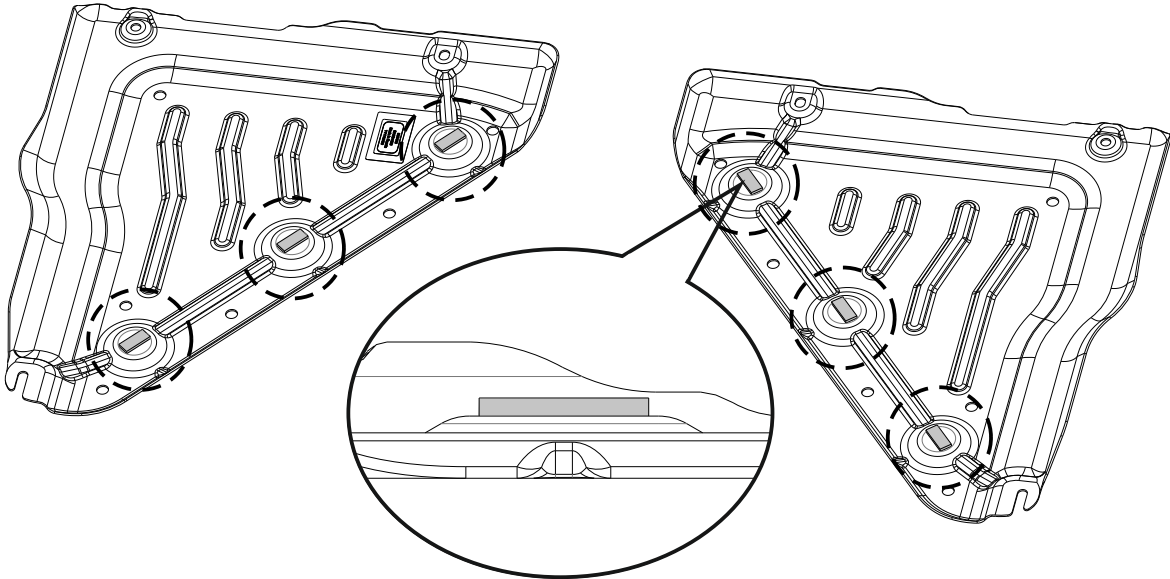

2

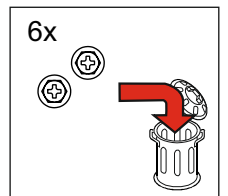
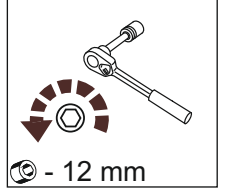
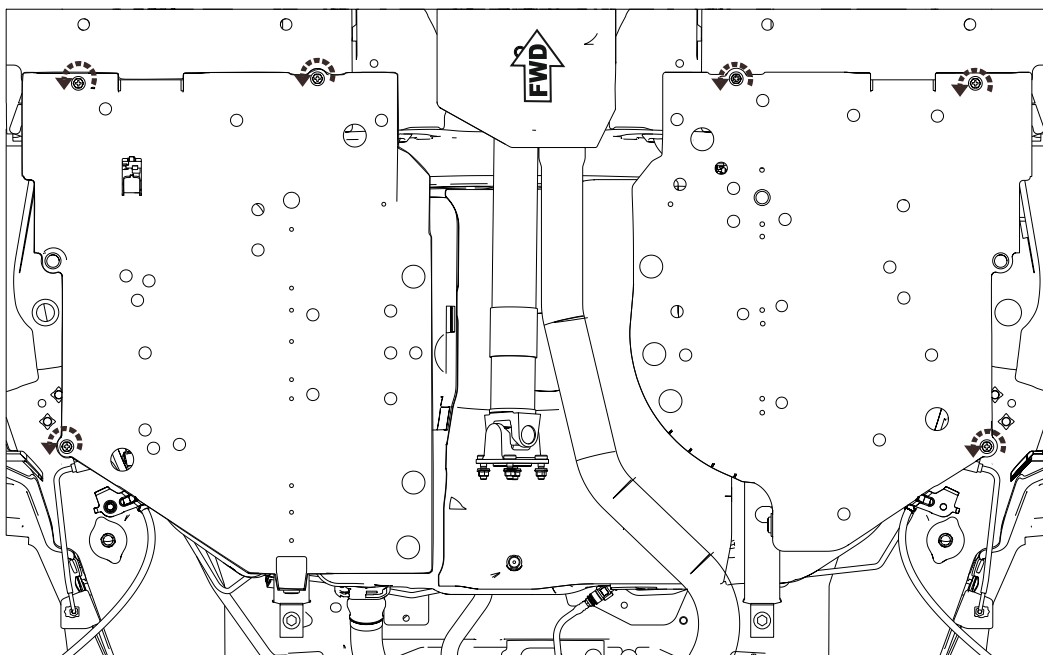

3

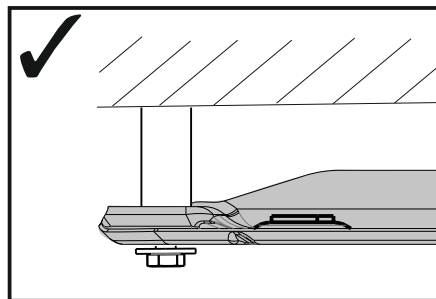
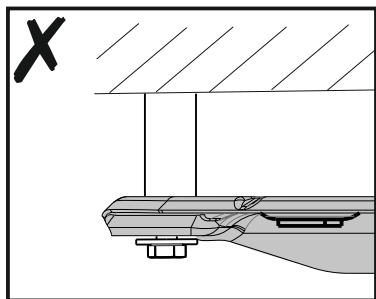
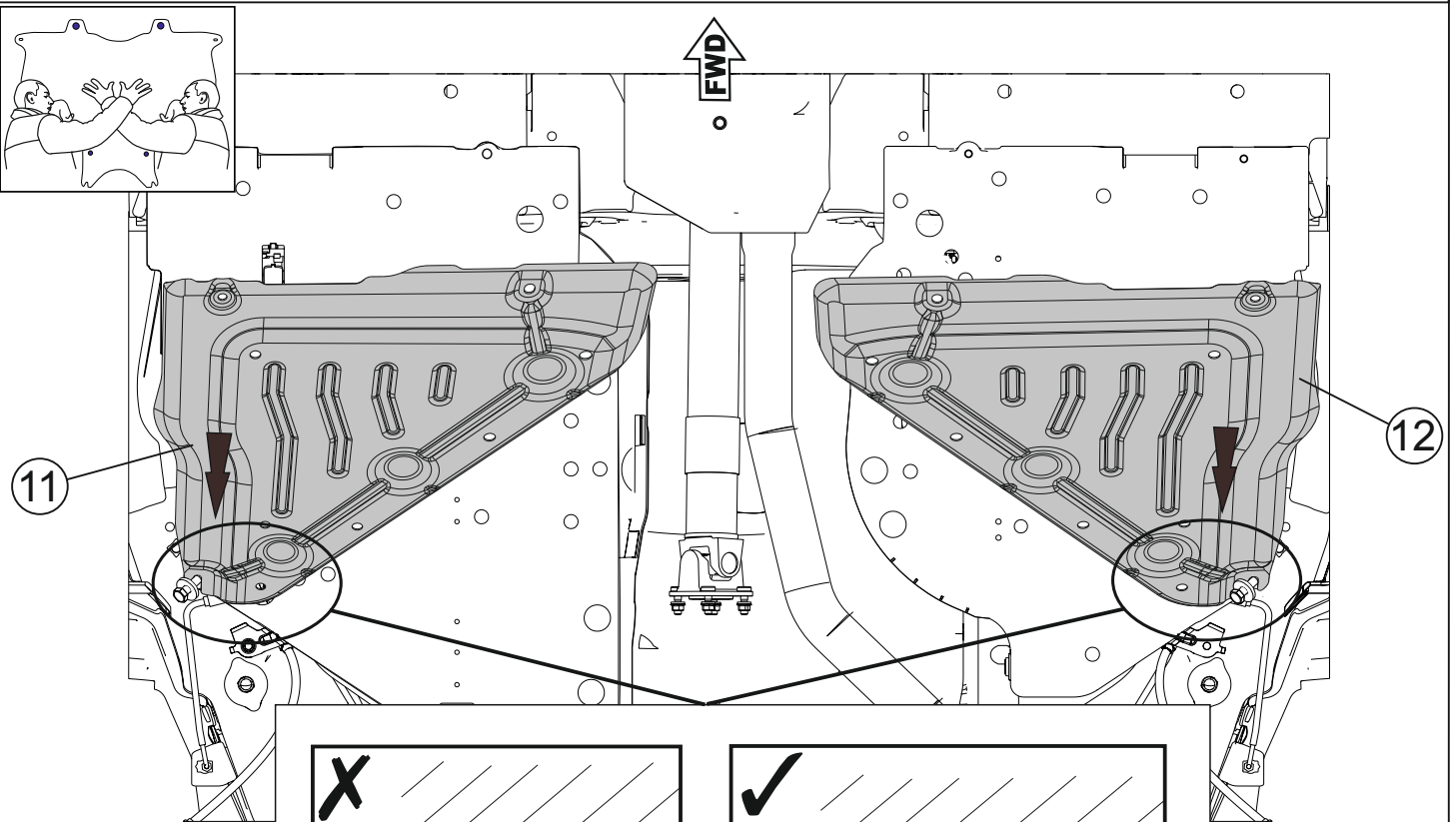
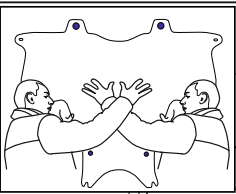
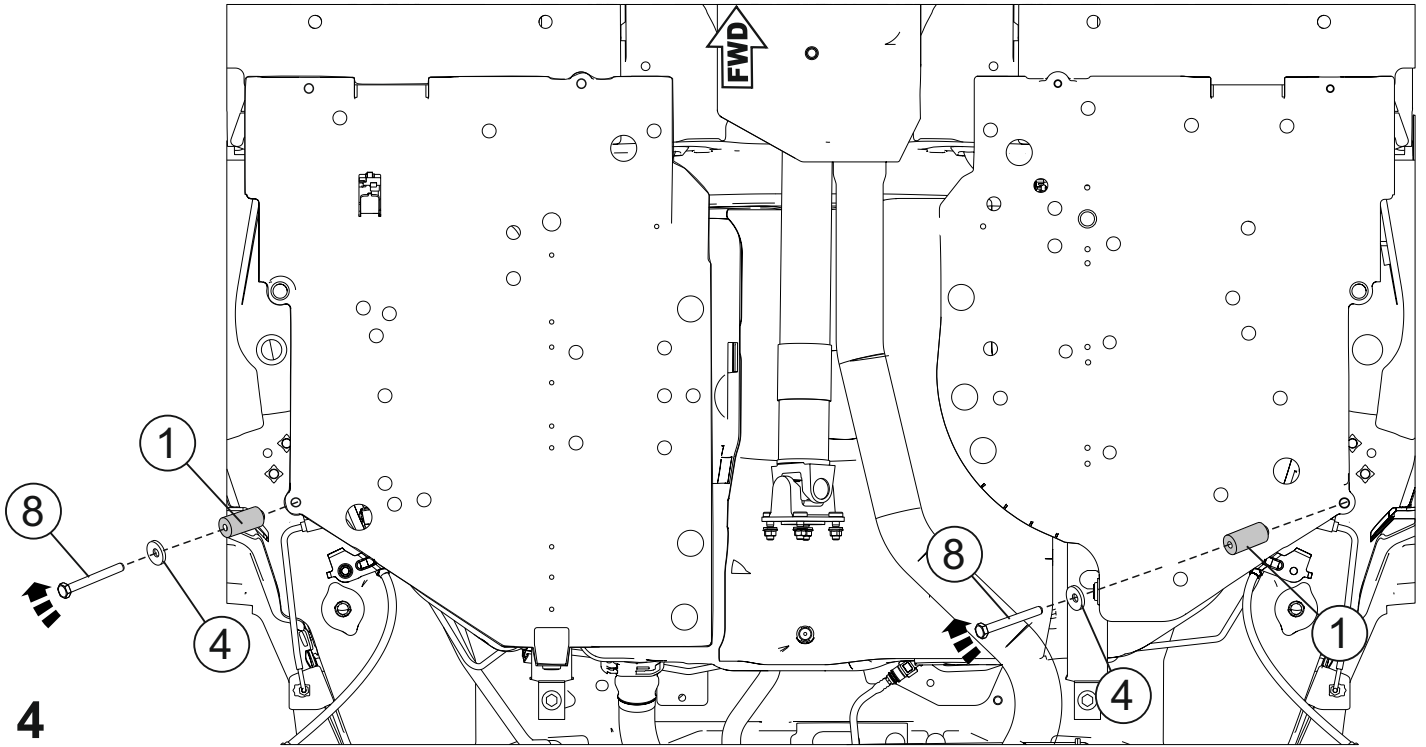
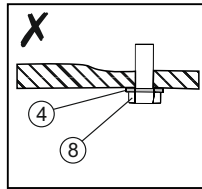
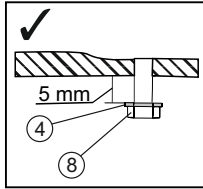
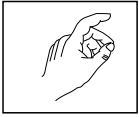

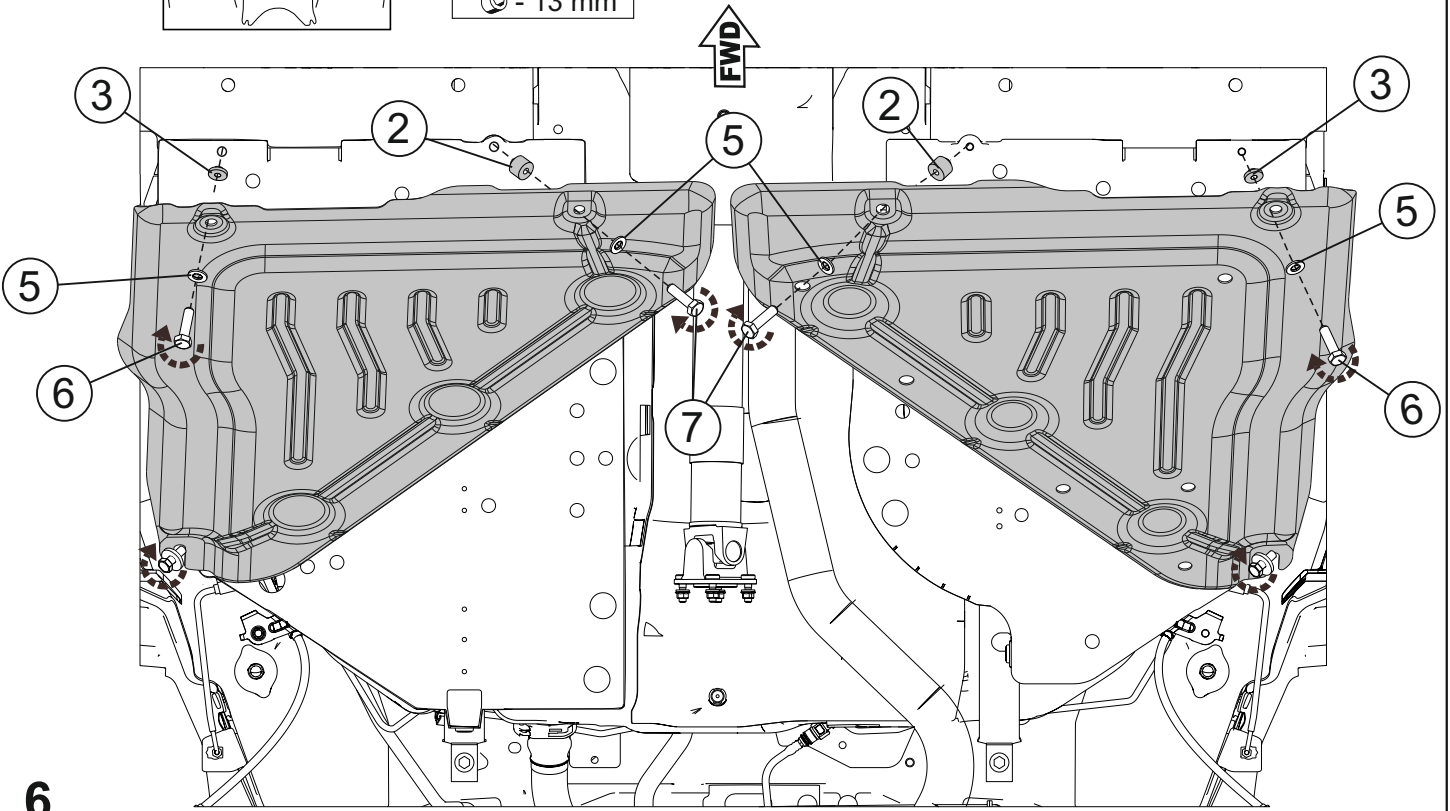
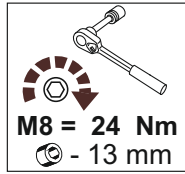
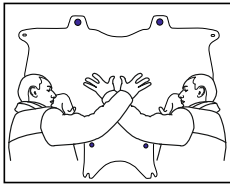

GB ATTENTION

Important notice! Guarantee/compensation claims will be automatically rejected if assembly has not been carried out correctly (in accordance with the instructions contained in this installation sheet) or in a specialist workshop.

We would expressly point out that any improper assembly/installation that has not been carried out in a specialist workshop will result in the invalidation of any kind of compensation claim, in particular, those arising by virtue of the product liability law.

The type no:
is constructed for the above vehicle and can only be mounted on said vehicle.
For the purpose of installation, please use the included fixation parts only.

FR ATTENTION

Nous attirons votre attention sur le fait toute réclamation ou demande de dommages et intérêts ne pourrait être formulée dans la mesure où le montage aura été effectué en suivant les instructions techniques prévues pour notre produit.

Le non-respect des instructions de montage entrainerait la non-recevabilité de toute réclamation.

Ce modèle
est conçu pour le véhicule indiqué ci-dessus et ne peut être monté uniquement sur ce véhicule. Pour la fixation, utiliser exclusivement les pièces ci-jointes.

DE ACHTUNG

Wichtiger Hinweis! Gewährleistungs- bzw. Schadensersatzansprüche werden automatisch zurückgewiesen, falls die Montage unsachgemäß (d.h. nicht entsprechend den Anweisungen in dieser Montageanleitung) oder nicht in einer Fachwerkstatt durchgeführt wurde.

Wir weisen ausdrücklich darauf hin, daß eine unsachgemäße, nicht in einer Fachwerkstatt durchgeführte Montage, zum Ausschluß jeglicher Schadensersatzansprüche, insbesondere solcher aus dem Produkthaftungsgesetz, führt.

Der Typ Nr.
ist für das oben aufgeführte Fahrzeug konstruiert und darf nur auf diesem Fahrzeug montiert werden. Für die Befestigung sind ausschließlich die beiliegenden Befestigungsteile zu verwenden.

IT ATTENZIONE

Attiriamo la vostra attenzione sul fatto che ogni eventuale reclamo o richiesta di risarcimento verterà da noi esaminata soltanto se l'installazione è stata eseguita correttamente (in base alle istruzioni tecniche contenute nel nostro manuale) o presso uno dei nostri concessionari. A tal proposito vorremmo evidenziare che in caso di assemblaggio incorretto eseguito senza gli strumenti tecnici adeguati o non presso uno dei nostri concessionari non sarà possibile avvalersi di alcuna richiesta di risarcimento, in particolare non di quelle previste dalla legge della responsabilità del prodotto.

Il tipo no :
è prodotto per il veicolo sopra menzionato e può essere montato soltanto sul suddetto veicolo. Per fissare tale prodotto si prega di utilizzare soltanto i pezzi allegati.

RU ВНИМАНИЕ

Важное предупреждение! Гарантийные требования и требования о компенсации будут автоматически отклонены в случае если сборка и/или установка произведены неверно (в соответствии с данной инструкцией) или не специалистами специализированного сервисного центра. Обращаем особое внимание на то, что любые недостатки сборки и/или установки, если они выполнены не в специализированном сервисном центре делают несостоятельными любые претензии и требования компенсации, в частности, на основании закона об ответственности за продукт.

Модель номер:

сконструирована для указанной модели автомобиля и может устанавливаться только на данную модель.

Для установки используйте только детали крепежа, входящие в комплект.